



INSTALLATION, USE & CARE MANUAL

30" DOUBLE BUILT-IN OVEN

FD30CONXE (FD..PQC1XE.UA)
FD30CONXT (FD..PKC1XE.UA)
FD30PROX (FD..PAZ1XE.UA)
FD30PROXE (FD..PAU1XE.UA)
FD30PROXT (FD..PHU1XE.UA)



BERTAZZONI SpA
Via Palazzina 8
42016 Guastalla RE
ITALY

WWW.BERTAZZONI-ITALIA.COM

FROM THE DESK OF THE PRESIDENT

Dear new owner of a Bertazzoni product,

I want to thank you for choosing one of our beautiful products. We know that you have many brands and products to choose from and we are thrilled that you have decided to take one of our products into your home.

We take as much pride in making our products as we hope you will in owning them. My family started manufacturing cooking appliances in 1882. Each of our products is a blend of Italian design finesse and superior appliance technology. While we will never replace your unique talent at preparing delicious dishes, we try our best at making cooking easier, more effective and more fun.

Our appliances are designed according to the strictest safety and performance standard for the European and the North American market. We follow the most advanced manufacturing techniques. Each appliance leaves the factory after thorough quality inspection and testing. Our distributors and our service partners are ready to answer any questions you may have regarding how to install, use and care for your Bertazzoni product.

This manual will help you learn to use the product safely and most effectively and care for it so that it may give you the highest satisfaction for years to come.

The manual also includes directions for the professional installer that will install the product in your home. We recommend using factory-trained professionals for the delicate task of installing and testing appliances in your home. Please call Customer Service if you need help locating a factory-trained professional installer in your area.

Please keep this manual handy for future use.

Grazie!

TABLE OF CONTENTS

APPLIANCE INFORMATION _____	4
<i>WARRANTY AND SERVICE</i> _____	5
IMPORTANT SAFETY INSTRUCTIONS _____	6
PRODUCT SPECIFICATION _____	9
INSTALLATION INSTRUCTIONS _____	12
CARING FOR THE ENVIRONMENT _____	12
WIRING DIAGRAM _____	13
CUT-OUT DIMENSIONS _____	15
INSTALLING THE OVEN _____	16
GETTING STARTED _____	17
USING THE LCD DISPLAY _____	20
BEFORE USING THE OVEN _____	23
BASIC OPERATION - DESIGN SERIES MODELS _____	24
BASIC OPERATION – PROFESSIONAL SERIES MODELS _____	25
TIME MANAGEMENT MENU – TIMER, DELAY/END COOKING, FOOD PROBE _____	26
COOKING MODES GUIDE _____	29
BROIL / CONVECTION BROIL _____	30
TIPS FOR BEST RESULTS – BROILING AND ROASTING _____	30
TIPS FOR BEST RESULTS - BAKING _____	31
TIPS FOR BEST RESULTS - WARMING _____	31
TIPS FOR BEST RESULTS - DEHYDRATE _____	32
ASSISTANT FUNCTION _____	33
SABBATH MODE _____	38
SELF-CLEANING CYCLE _____	39
CLEANING THE OVEN _____	40
REPLACING THE OVEN LIGHTS _____	41
TROUBLESHOOTING GUIDE _____	42

APPLIANCE INFORMATION

MODEL

DATE INSTALLED

DEALER

INSTALLER

SERVICER

WARRANTY AND SERVICE

All Bertazzoni products are covered by a 2 years parts and labor warranty.
Service on all Bertazzoni products shall be carried out by factory-trained professionals only.
For warranty service please contact Customer Service at the numbers indicated below.

CUSTOMER SERVICE

English/Spanish hotline	(866) 905-0010
French hotline	(800) 561-7625
Fax	(714) 428-0040
Email BERTAZZONIHHELP@SERVICEPOWER.COM	

Mailing address

SERVICEPOWER
1503 South Coast drive
Suite 320
Costa Mesa CA 92626

REPLACEMENT PARTS

Only Bertazzoni replacement parts may be used in performing service on the appliance.
Replacement parts are available from factory authorized parts distributors.

IMPORTANT SAFETY INSTRUCTIONS

Read these instructions before installing or using the oven for the first time.

Save these instructions and review them periodically.

Keep the instructions in a safe place and transfer them to any future user.

General

This appliance complies with current safety requirements.

The appliance is intended for domestic use only: cooking, baking, roasting, broiling, defrosting and heating of food. It is not designed for industrial or laboratory use.

Only use the appliance for its intended purpose. Improper use of the appliance can lead to personal injury and property damage. The manufacturer is not liable for personal injury, product or property damage caused by improper use of this oven.

Those who lack physical, sensory or mental abilities, or experience with the appliance should not use it without supervision or instruction by a responsible person.

Children

Children should not be left unattended in an area where the appliance is in use.

Never allow children to hang or lean on any part of the appliance.

CAUTION! Do not store items of interest to children in cabinets above an oven. Children climbing on the oven to reach these items could be injured.

Children should not use the unit without supervision unless its operation has been sufficiently explained so they can use it safely. Children must be able to understand potential hazards or improper operation.

Do not allow children to touch or play in, on or near the oven when it is in operation. The oven gets hot at the oven door glass, the cooling exhaust, the handle and the operating controls. Use extra care to avoid burns.

Installation

Before installation, make sure that the voltage and frequency listed on the data plate correspond with the household's electrical supply to prevent personal injury and/or damage to the appliance. Consult a qualified electrician if in doubt.

Make sure your appliance is properly installed and grounded by a qualified technician.

CAUTION: The appliance must be effectively grounded to guarantee the electrical safety. If in doubt, have the electrical system of the house checked by a qualified electrician. The manufacturer is not liable for damages caused by the lack or inadequacy of an effective grounding system or the failure to adhere to national and local electrical codes.

The oven should not to be operated until it has been properly installed.

Installation, maintenance and repair work should be performed by a factory authorized service technician. Work by unqualified persons could be dangerous and may void the warranty.

Before installation or service, disconnect the power supply to the work area by removing the fuse, tripping the circuit breaker or shutting off the power main.

WARNING! ELECTRICAL SHOCK HAZARD!

Disconnect electrical power at the circuit breaker box or fuse box before installing the appliance.

Provide appropriate grounding for the appliance.

Use copper conductors only.

Failure to follow these instructions could result in serious injury or death

CAUTION! Label all wires prior to disconnecting when servicing controls. Wiring errors can cause improper and dangerous operation.

Verify proper operation after servicing.

Oven use

WARNING! Ovens can produce high temperatures that can cause burns.

Prevent children from touching the appliance while in use.

Use heat-resistant potholders when placing items in the oven, turning them, or removing them from the oven. The upper heating element and oven racks can become very hot and cause burns.

To prevent burns, always place oven racks at their desired height while the oven is cool.

Open the door carefully to allow hot air or steam to escape before placing or removing food.

To prevent burns, allow the heating element to cool before cleaning by hand.

During the self cleaning function the oven will become very hot. Prevent children from coming in contact with the oven.

Remove all accessories from the oven before starting a self-clean cycle. The high temperatures needed for this program will damage the accessories.

The door gasket is essential for a good seal. Care should be taken not to wear, damage or remove the gasket.

Only clean parts listed in this manual.

CAUTION: Heating elements may be hot even though they are not glowing. During and after use, do not let clothing or other flammable materials come in contact with heating elements or interior surfaces of the oven until they have had sufficient time to cool. External parts of the oven such as the door glass, vents, and the control panel can become hot.

Do not block the exhaust vents.

Aluminum foil should not be used to line the bottom of the oven cavity.

Do not place pots, pans or baking sheets directly on the bottom of the oven cavity.

Do not slide pots or pans on the oven floor. This could scratch and damage the surface enamel.

Do not let metal objects (aluminium foil, pans) or the meat probe come in contact with the heating element.

Do not sit or step on the oven door.

Do not place heavy items on the open oven door.

Only use the food probe supplied with the oven. Contact Bertazzoni Service if you need to purchase a new probe.

To prevent damage, remove the food probe from the oven when it is not being used.

Do not heat unopened containers of food in the oven, pressure may build up and cause them to explode.

Never add water to food on a hot tray or pan, or directly onto food in a hot oven. The steam generated could cause serious burns or scalds.

This oven must only be used for cooking. Do not use it as a dryer, kiln, dehumidifier, etc. Fumes or vapors given off by glues, plastics or flammable liquids and materials could be hazardous.

Never store flammable liquids and materials in, above or under an oven, or near cooking surfaces.

Do not use the appliance to store or dehydrate flammable materials. This is a fire hazard.

Do not use the oven to heat the room.

When baking frozen pizzas or pies, place them on the rack lined with parchment paper. Frozen food like french fries, fish sticks, chicken fingers etc. can be baked on the baking tray.

Always check that food is sufficiently heated. The time required varies depending on a number of factors, such as initial temperature, quantity of food, type and

consistency of the food, and recipe. Germs present in the food are killed off only at a sufficiently high temperature (> 158F / 70C) and after a sufficiently long time (10 minutes or longer). Select a longer cooking time if you are unsure whether the food is thoroughly heated. To ensure temperature is distributed evenly, stir food before serving.

It is recommended to cover all cooked food that is left in the oven to be kept warm. This will prevent moisture from condensing on the interior of the oven.

Be careful when cooking with alcoholic beverages like rum, whiskey, wine etc. The alcohol evaporates at high temperatures but may in rare circumstances combust on the hot heating elements.

Other

Do not use a steam cleaner to clean the oven. Steam could penetrate electrical components and cause a short.

Do not leave the oven unattended when cooking with oils or fats, they are a fire hazard if overheated.

Do not use water on grease fires! Smother the fire with a properly rated dry chemical or foam fire extinguisher.

Be aware of loose or hanging garments while operating the cooktop, they present a fire hazard.

Make certain that the power cords of small appliances do not come in contact with or get caught in the oven door.

Use only dry, heat-resistant potholders. Moist or damp potholders used on hot surfaces may result in steam burns. Do not let potholders come in contact with oils. Do not substitute towels or other bulky items for potholders.

SAVE THESE INSTRUCTIONS AND REVIEW THEM PERIODICALLY.

PRODUCT SPECIFICATION

PROFESSIONAL SERIES OVENS (PRO MODELS)

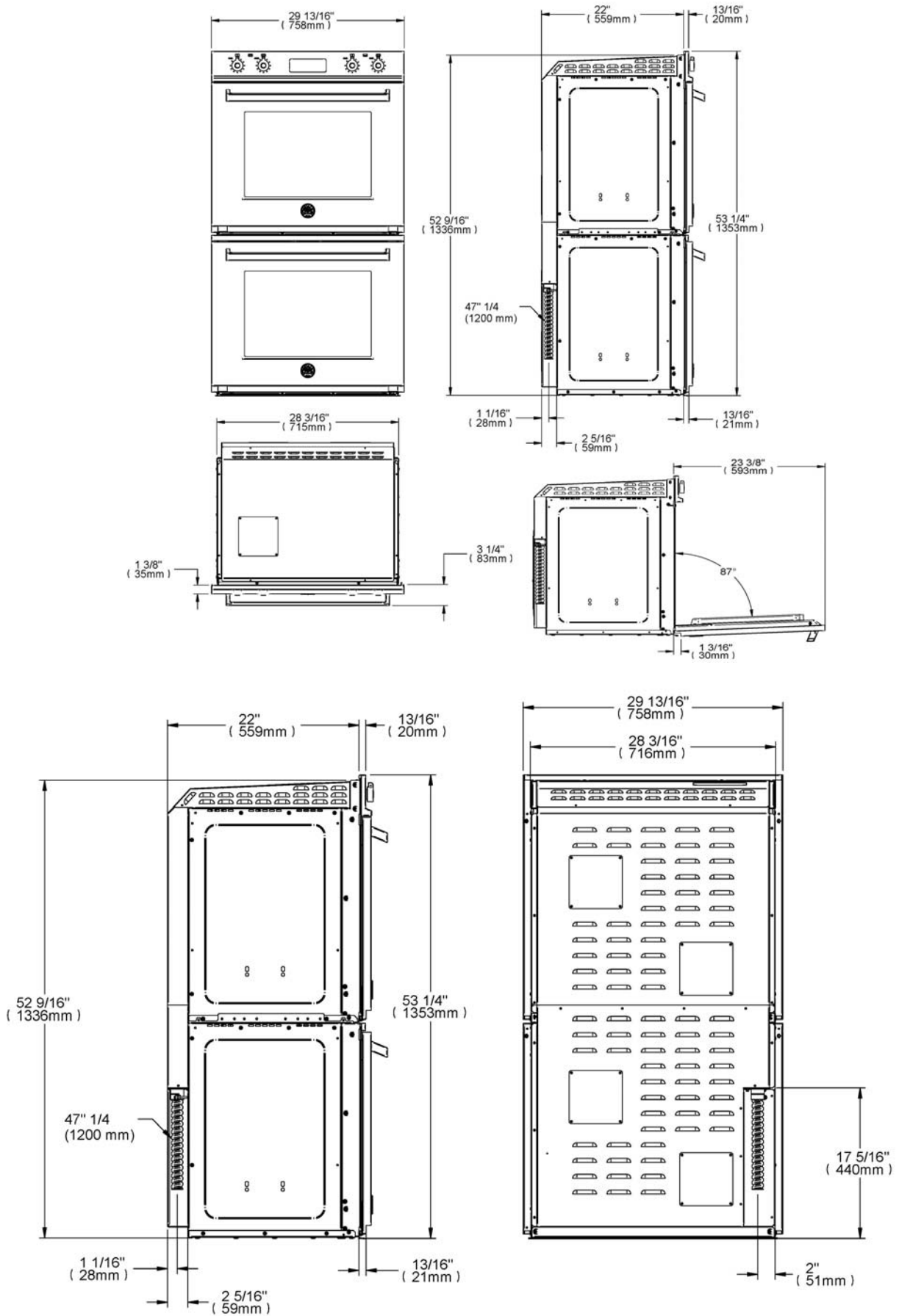

PRODUCT SPECIFICATION

DESIGN SERIES OVENS (CON MODELS)

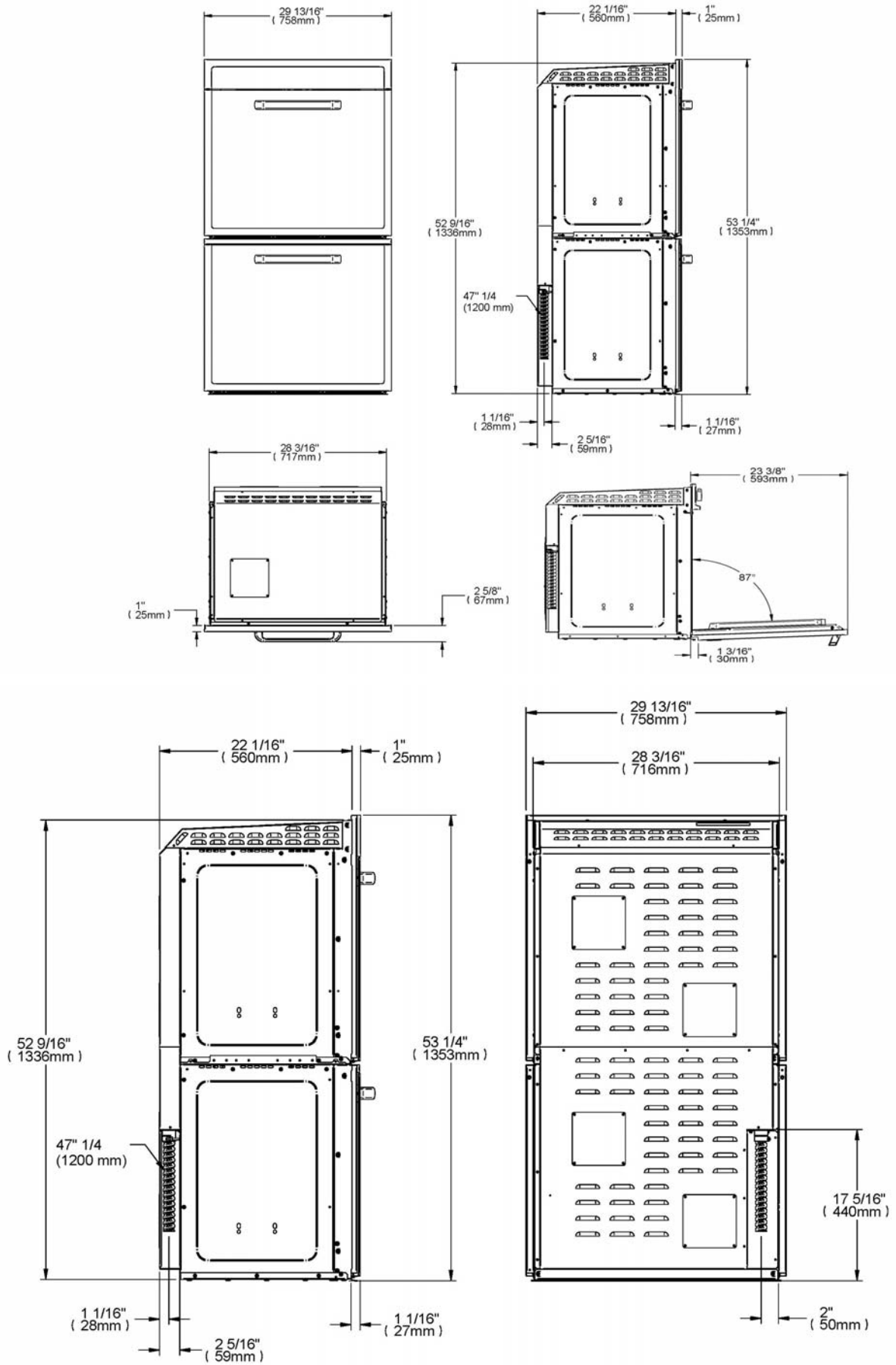

Electrical requirements

120/240V - 11000W (48 A max) or 120/208V – 8800W (42 A max).

Upper cavity

Upper heating element	3400W
Lower heating element	2100W
Convection heating elements	2 x 1650W

Lower cavity

Upper heating element	3400W
Lower heating element	2100W
Convection heating elements	2 x 1650W

INSTALLATION INSTRUCTIONS

INSTALLER: PLEASE LEAVE THESE INSTRUCTIONS WITH THE OWNER.

Electrical connection

CAUTION: Before installing the oven, disconnect the power supply by either removing the fuse, shutting off the power main or manually tripping the circuit breaker.

Installation work and repairs should only be performed by a qualified technician in accordance with all applicable codes and standards. Repairs and service by unqualified persons could be dangerous and may void the warranty. The manufacturer is not liable for personal injury, product or property damage caused by serviced performed by unqualified persons.

Before connecting the appliance to the power supply, make sure that the voltage and frequency listed on the data plate correspond with the household electrical supply. This data must correspond to prevent damage to the product. Consult an electrician if in doubt.

Only operate the appliance after it has been installed in a cabinet.

Power supply

The oven is equipped with a 4 ft. (1.2 m.) flexible metal cable with 4 wires ready for connection to a dedicated 3 pole, 4 wire grounded power supply:

120/240Vac: 11000 Watt or 48 A max.

or

120/208Vac: 8800 Watt or 42 A max.

Black wire: connect to L1 (hot)

Red wire: connect to L2 (hot)

White wire: connect to N (neutral)

Green wire: connect to GND (ground)

A dedicated line and junction box should be used to connect the oven to a 50 A circuit.

CARING FOR THE ENVIRONMENT

Disposal of packing materials The cardboard box and packing materials protect the appliance during shipping. Ensure that any plastic wrappings, bags, etc. are disposed of safely and kept out of the reach of children. Danger of suffocation!

Disposal of an old appliance Old appliances may contain materials that can be recycled. Please contact your local recycling authority about the possibility of recycling these materials. Make sure that the appliance presents no danger to children while being stored for disposal. Before discarding an old appliance, unplug it from the outlet and cut off its power cord. Remove any doors to prevent trapping hazards.

WIRING DIAGRAM

Models: FD30PROX - FD30PROXE - FD30PROXT

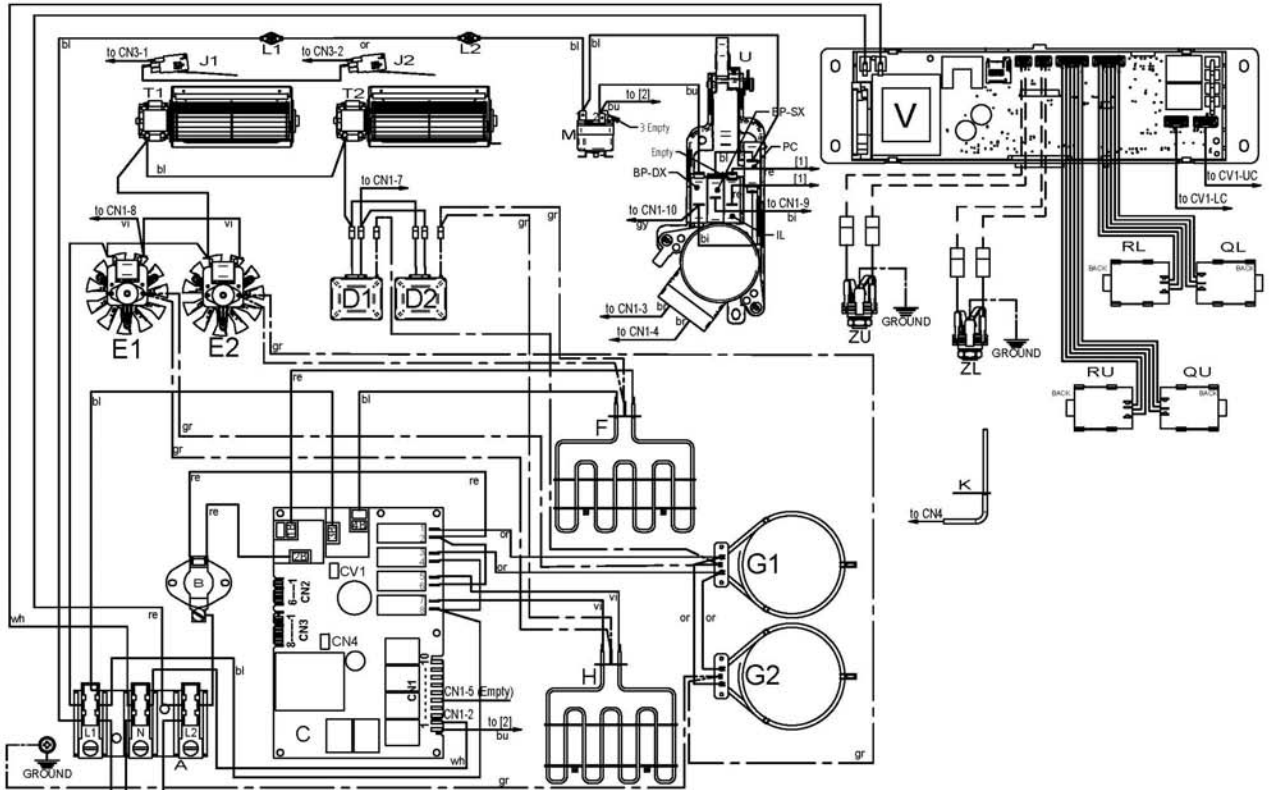

UPPER CAVITY
LOWER CAVITY

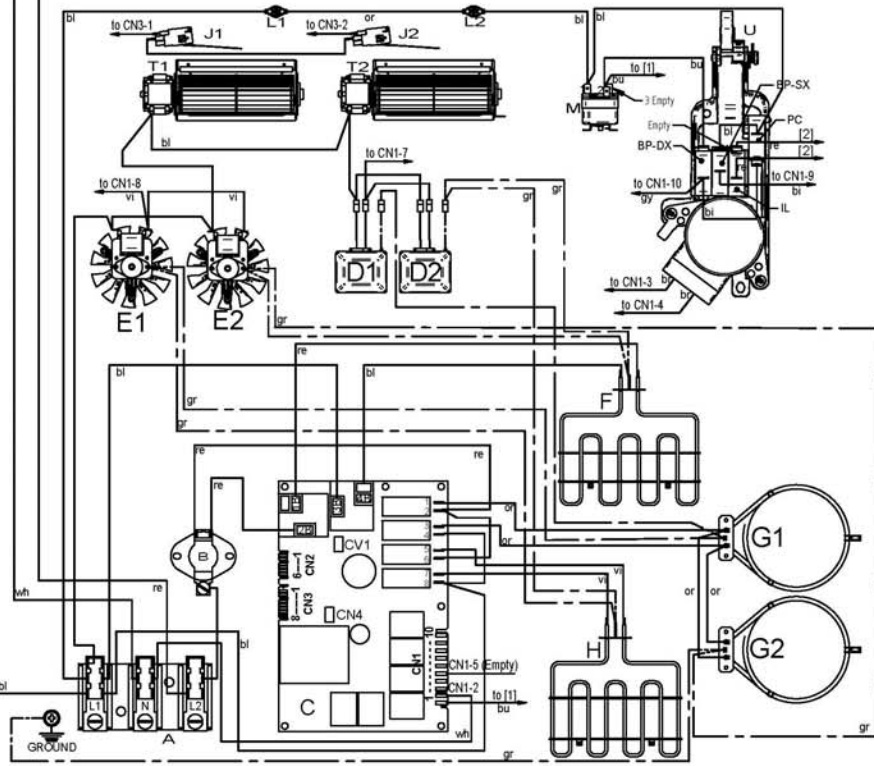

WIRES COLOURS LEGENDA	
bl	BLACK
br	BROWN
bu	BLUE
gr	GREY
gr	GREEN
or	ORANGE
re	RED
vi	VIOLET
wh	WHITE

LEGENDA	
A	Terminal Block
B	Thermal Cut-out [TC1]
C	Main oven control board
D1	Oven Lamp (Right)
D2	Oven Lamp (Left)
E1	Oven Fan motor (Right)
E2	Oven Fan motor (Left)
F	Broiler Heating Element
G1	Circular Heating Element (Right)
G2	Circular Heating Element (Left)
H	Bottom Heating Element
J1	Cooling Fan Air Switch (Right) [MT2-1]
J2	Cooling Fan Air Switch (Left) [MT2-2]
K	Oven Temp. Sensor [PT 1000]
L1	Thermal Cut-out (Right) [TC2]
L2	Thermal Cut-out (Left) [TC3]
M	Safety Fixed Thermostat [TSS]
OU	Oven Functions Selector (Upper Cavity)
OL	Oven Functions Selector (Lower Cavity)
RU	Oven Temperature Selector (Upper Cavity)
RL	Oven Temperature Selector (Lower Cavity)
T1	Cooling Fan Motor (Right)
T2	Cooling Fan Motor (Left)
U	Door Lock + Door Switch System
V	Display
ZU	Meat Probe (Upper Cavity)
ZL	Meat Probe (Lower Cavity)

WIRING DIAGRAM

Models: FD30CONXE - FD30CONXT

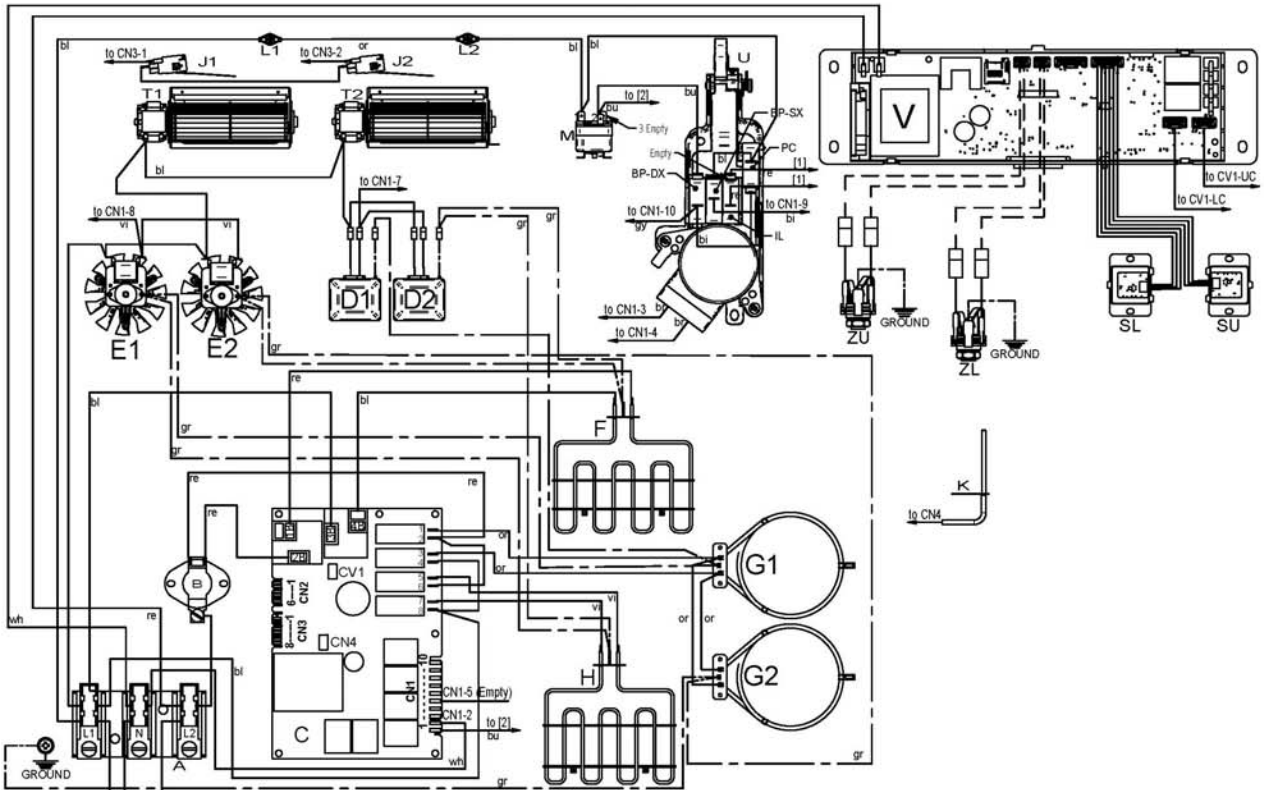

UPPER CAVITY
LOWER CAVITY

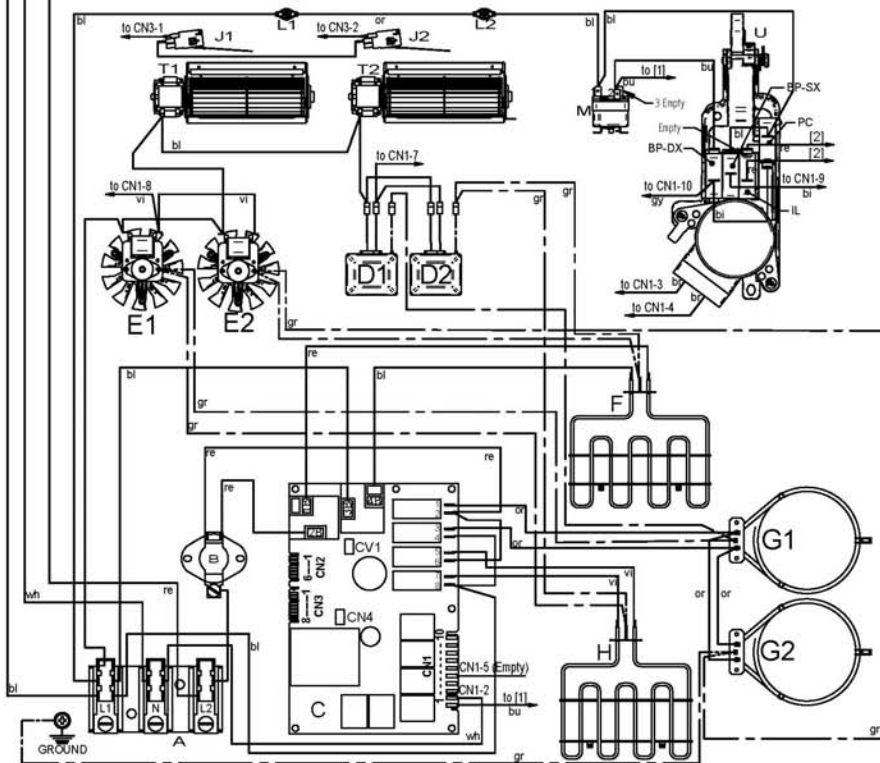

WIRES COLOURS LEGENDA	
bl	BLACK
br	BROWN
bu	BLUE
gr	GREY
gr	GREEN
or	ORANGE
re	RED
vi	VIOLET
wh	WHITE

LEGENDA	
A	Terminal Block
B	Thermal Cut-out [TC1]
C	Main oven control board
D1	Oven Lamp (Right)
D2	Oven Lamp (Left)
E1	Oven Fan motor (Right)
E2	Oven Fan motor (Left)
F	Broiler Heating Element
G1	Circular Heating Element (Right)
G2	Circular Heating Element (Left)
H	Bottom Heating Element
J1	Cooling Fan Air Switch (Right) [MT2-1]
J2	Cooling Fan Air Switch (Left) [MT2-2]
K	Oven Temp. Sensor [PT 1000]
L1	Thermal Cut-out (Right) [TC2]
L2	Thermal Cut-out (Left) [TC3]
M	Safety Fixed Thermostat [TSS]
SL	Lower Cavity Selector
SU	Upper Cavity Selector
T1	Cooling Fan Motor (Right)
T2	Cooling Fan Motor (Left)
U	Door Lock + Door Switch System
V	Display
ZU	Meat Probe (Upper Cavity)
ZL	Meat Probe (Lower Cavity)

CUT-OUT DIMENSIONS

IMPORTANT

Kitchen cabinets shall be made of materials capable of withstanding temperatures at least 117°F (65°C) above room temperature in order to avoid possible damage to the cabinets during oven usage.

The oven must be installed into cabinetry and be supported from underneath.

The oven vent at the bottom of the door must be left unobstructed.

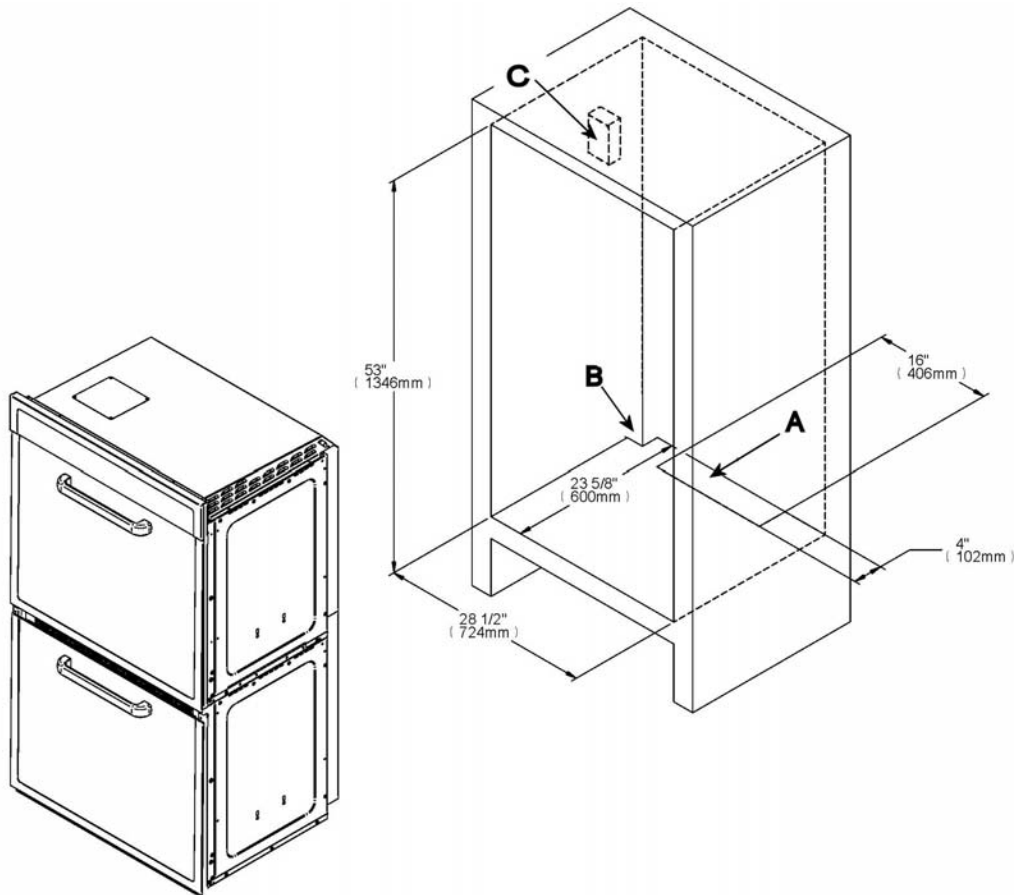

- A** Vent cut-out 16" x 4" (406mm x 102mm) in the base of the cabinet
- B** Cut-out for power cord min. 1" x 1" (2.54 x 2.54 cm.)
- C** Electrical connection box

Warning :

for a flush mount installation the surrounding cabinets doors should have the same thickness as the oven control panel (13/16" for PRO models and 1" for CON models).

INSTALLING THE OVEN

STEP 1

Fix the supplied skid plates to the cabinet floor.

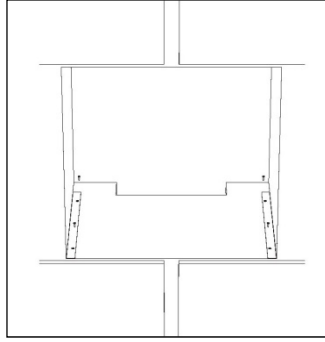

STEP 2

Prepare the door for removal. Flip up the locking clamps on each door hinge. Slowly shut the door until the protruding clamps stop the movement. Pull oven door upwards and remove.

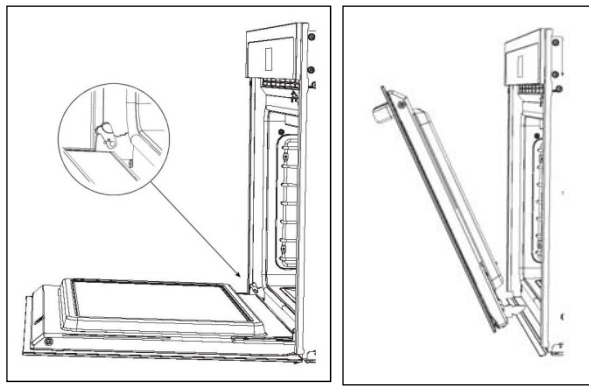

STEP 3

Connect the oven to the electrical supply.

STEP 4

Slide the oven into the cabinet and align.

STEP 5

Reinstall the oven door.

STEP 7

Open the oven door and locate the two mounting screw holes in the oven frame. Mark and drill $\frac{1}{4}$ " (6 mm) pilot holes. Secure the oven to the cabinetry by inserting screws through the frame and into the cabinetry. Assemble the supplied screw caps over the screw head to conceal them.

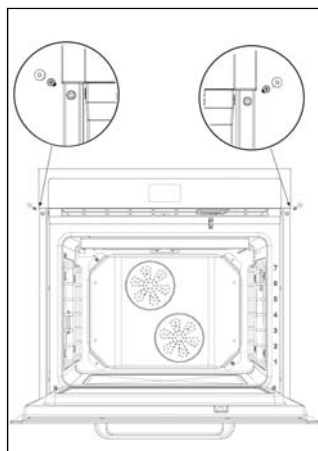

GETTING STARTED

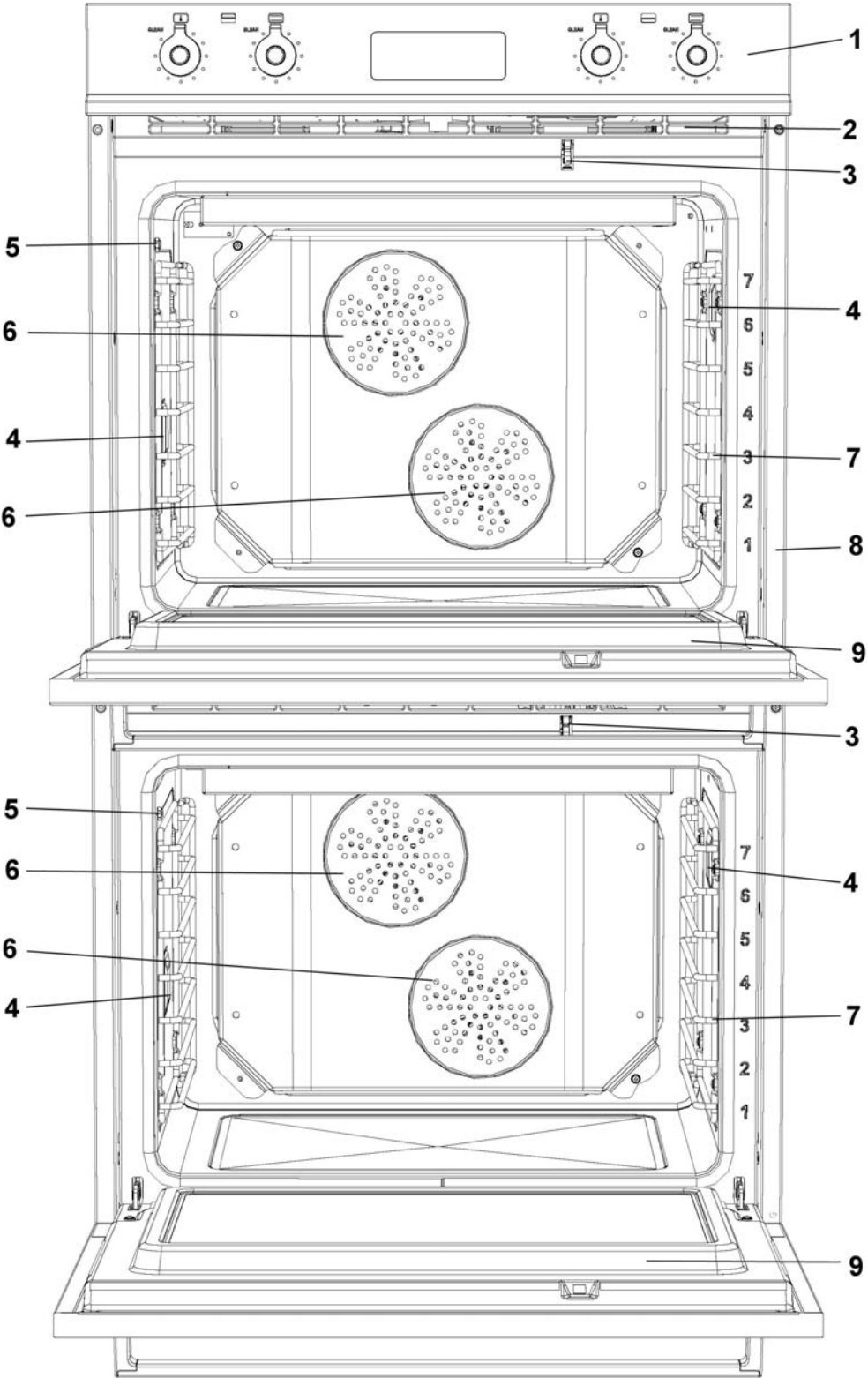

- 1 Control Panel (KNOBS only presents on PRO models)
- 2 Cooling exhaust
- 3 Self-clean cycle door lock
- 4 Lights
- 5 Food probe port (XT (models only)
- 6 Convection fans
- 7 Seven level shelf supports
- 8 Data plate
- 9 Oven door

COOLING FANS

Two cooling fans are concealed in the upper portion of the oven. They activate each time the internal temperature reaches 390F (200C) and continue to operate until the temperature drops to 230F (160C). Therefore the cooling fans may be on after the oven has been turned off. When the temperature inside the oven is over 280F (140C), the cooling fans activate each time the door is opened in order to avoid that the hot air escaping the cavity enters in contact with the control panel. Cooling fans are always operated when a cleaning cycle is selected.

NOTE: COOLING FANS ARE DIFFERENT FROM THE CONVECTION SYSTEM FANS, WHICH ARE PLACED AT THE BACK OF THE OVEN CAVITY.

OVEN LIGHTS

Oven lights are activated each time the door is opened and when the oven is in operation. In ECO mode, the oven lights will not turn on during operation to save energy. During the following functions the oven lights are not activated:

- Sabbath Mode
- Cleaning cycle
- Proofing
- Defrost

You can turn on the lights inside the oven by tapping  on the display.

STEEL RACKS

Slide the racks onto the runners on both sides of the oven. The racks have non-tip safety notches, which prevent them from being pulled out completely while the oven is in use.

When inserting a rack, always check that the safety notches are at the back. To remove racks, raise them upwards and pull out.

TELESCOPIC RACKS The oven is also equipped with full-extension telescopic racks that extend on ball bearing glides. The telescopic racks must be securely fastened to the side runners. Additional racks can be purchased as accessory (part # 901267).

To change shelf position:

- extract the rack out of the oven
- lift the rack to disengage the runners
- pull the rack out of the oven cavity
- close the rack
- install the rack in another position while completely closed

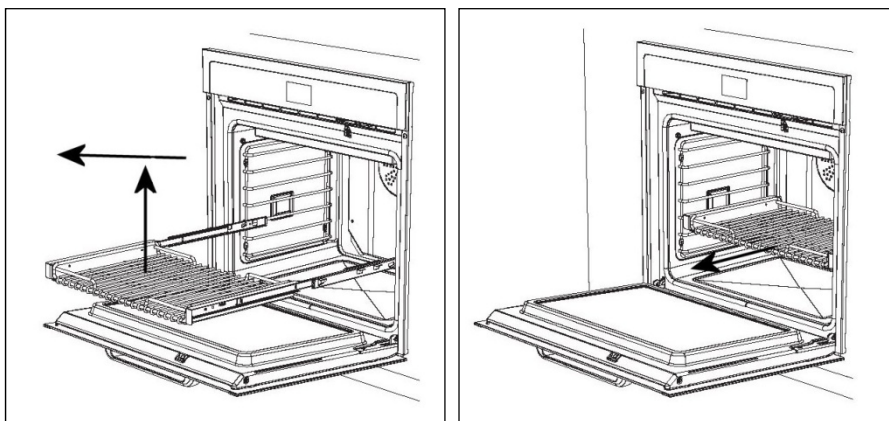

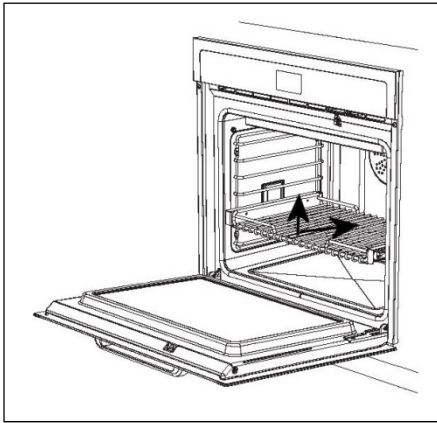
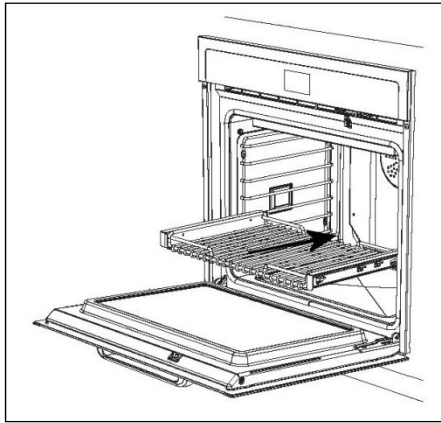
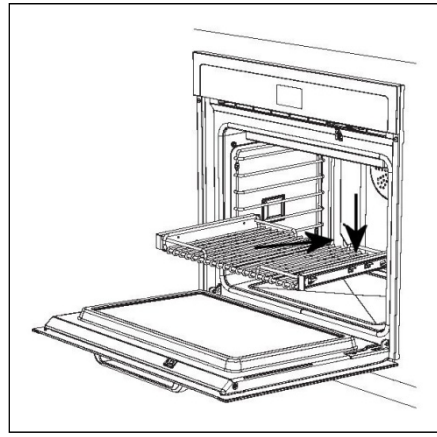
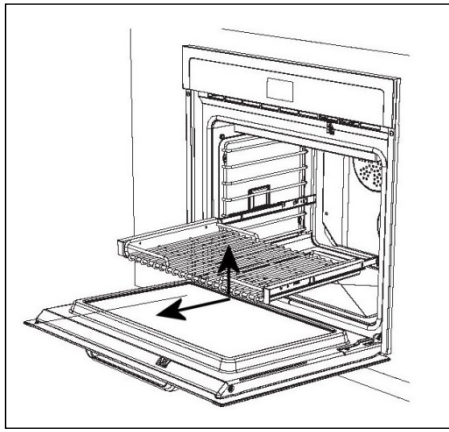

USING THE LCD DISPLAY

DESIGN SERIES OVENS (CON MODELS)

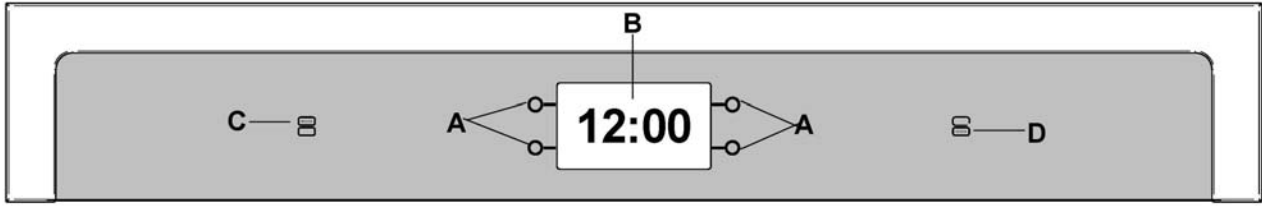

PROFESSIONAL SERIES OVENS (PRO MODELS)

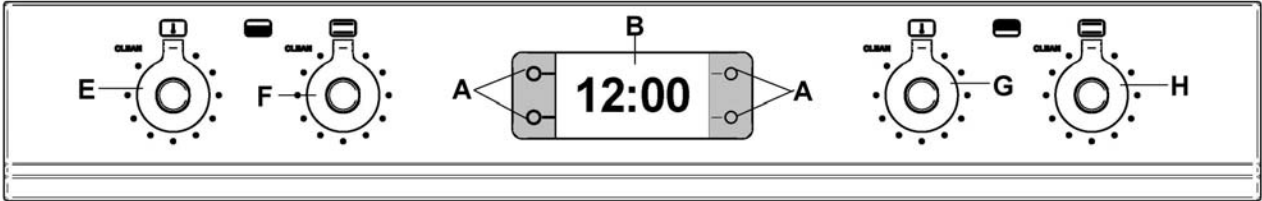

- | | |
|---|---|
| A Touch control areas | B LCD Display |
| C Upper cavity Touch control areas | D Lower cavity Touch control areas |
| E Lower cavity Temperature knob | F Lower cavity Cooking modes knob |
| G Upper cavity Temperature knob | H Upper cavity Cooking modes knob |



START

The LCD display can be operated 1 minute after the power supply is connected.

To activate the display:

DESIGN SERIES OVENS (CON MODELS)

Tap for 2 seconds any of the touch control areas (A). The following icons will appear:

Timer  Settings  Light  Start 

PROFESSIONAL SERIES OVENS (PRO MODELS)











Turn the cooking modes knob (right side). The following icons will appear:

Timer  Settings 

Once activated each menu will show the icons necessary for navigation and programming next to the touch control areas.

After 1 minute without operation the display will go in stand-by mode to reduce power consumption and the touch control areas will turn off. Touch any control area for 2 seconds to reactivate the display.

ICONS LEGEND

	Timer
	Light
	Settings menu
	Start
	Scroll left/right and up/down
	Confirm selection
	Remove selection or leave menu
OFF	Stop cooking
	Set cooking time, delay start/end time, food probe
	
	Modify cooking mode
	Modify cooking temperature

SETTINGS

Activate SETTINGS menu with 

Select field with   and confirm 

Set the desired values with   and confirm 

Leave menu 

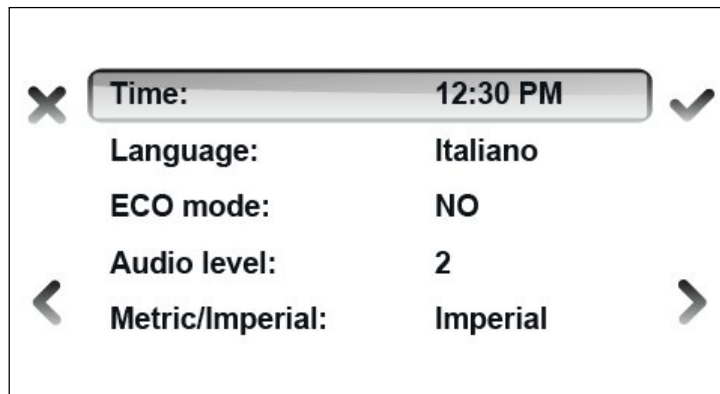

Notes

ECO mode: this setting reduces energy consumption by:

- turning off the oven before the end of a cooking program and using residual heat to complete the cooking
- switching off the oven light during cooking
- switching off the display in stand-by mode.



Audio Level Level 1 to 3. Level 1 is NO AUDIO

Metric /Imperial **Metric:** Celsius/Kg/24 hour clock
Imperial: Farenheit/Lbs/12 hour clock

SHOW ROOM mode: this option is for showroom demonstration. In showroom mode the heating elements are not activated. Never use this at home.

TIMER

Activate TIMER with 

Set desired time (max 10 hours) with   and confirm 

Leave menu 

Note

The timer can be used independently from cooking.

The display will show the countdown. A tone sound will be heard at the end of the countdown. To stop sound at the end of the countdown tap any touch control areas. To modify the timer enter this menu again.





LIGHT

Turn the oven light on and off by tapping this icon.

Note : this function is not available in the PRO series ovens.



BEFORE USING THE OVEN

Before using the oven for preparing food:



- Remove the protective film from the oven door and control panel
- Remove all accessories from the oven
- Remove all stickers from the baking tray, from the roasting pan or from the interior cavity of the oven
- Remove all spacers and packing material from the interior of the oven cavity
- Make sure the room is properly ventilated
- Run the oven for 2 hours at 500F / 260C in turbo mode.
- The two cavities are all identical in the double oven and can be operated at the same time, except for the pyrolytic cleaning function.
- The display will show the status of one of the two cavities at a time. The cavity shown on the display is indicated by the symbol  or  placed on the upper right corner.
- In most of the different operation menu the cavity displayed is shown on the screen by the symbol  or 
- To switch the display from one cavity to the other :

PRO models :

A – in stand – by condition operate the function control knobs

B- during operation : touch the area indicated by the symbol  or  on the left side of the display

CON models

Always touch the dedicated areas indicated by the symbol  or  on the control panel.
The switch of the display is confirmed by sound.

The touch area will remain lit for 3 seconds after the touch.

- The oven will normally work even if its status is not displayed. In case an event happens in a cavity when the oven status is not displayed (e.g. end of cooking function or request of introduction of a food probe) the interface display will automatically switch to this oven status.
- It is always possible to switch from one oven status to the other using the different switch buttons.
- The modification of the oven parameters affects both cavities at the same time and it is only possible when both cavities are switched off.
- In case of a malfunction on one of the cavity, depending on the type of malfunction it will be possible to continue to operate the other cavity. Specific warning messages will be displayed.

This pre-operating procedure will ensure that all internal residues burn off prior to preparing food.

BASIC OPERATION - DESIGN SERIES MODELS

START

Activate the oven by touching any control area for 2 seconds.

Start programming with 

Select COOKING MODES   and confirm 

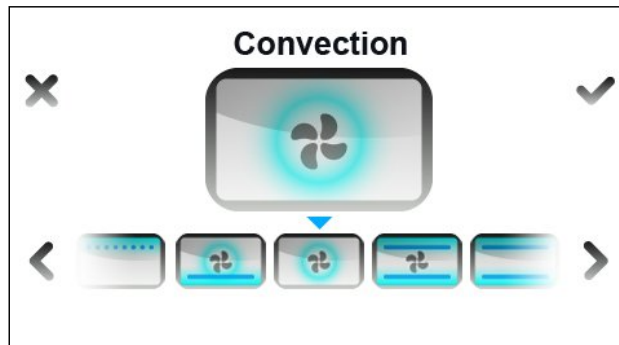

Set desired COOKING TEMPERATURE   and confirm 

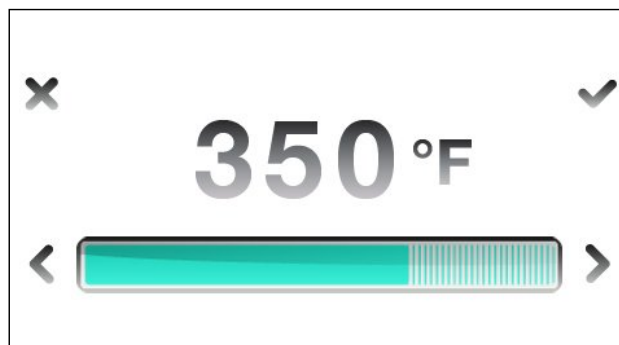

The oven will start PRE-HEATING in a few second showing the progress in the display. The end of pre-heating will be confirmed with a tone. Place the food in the oven when the desired temperature has been reached.

Note

The preheating bar is not shown.in broil, convection broil, dehydrate, defrost, warming and proofing modes.



MODIFY/STOP

Modify COOKING MODE during cooking with 

Modify COOKING TEMPERATURE during cooking with 

STOP cooking with **OFF** and confirm 

BASIC OPERATION – PROFESSIONAL SERIES MODELS

START

Activate the oven by turning the COOKING MODE knob (right)

Select COOKING MODE by turning the right knob

Select COOKING TEMPERATURE by turning the temperature left knob

The oven will start PRE-HEATING in a few second showing the progress in the display. The end of pre-heating will be confirmed with a tone. Place the food in the oven when the desired temperature has been reached.

Note

The preheating bar is not shown-in broil, convection broil, dehydrate, defrost, warming and proofing modes.

In order to shorten the heat-up time the preheating is always done with turbo mode

Each cooking mode has a default optimum temperature that appears as soon the cooking mode is selected

MODIFY/STOP



Modify COOKING MODE during cooking by turning the cooking mode knob

Modify COOKING TEMPERATURE during cooking by turning the temperature knob

Stop cooking by turning the function knob in the OFF position

TIME MANAGEMENT MENU – TIMER, DELAY/END COOKING, FOOD PROBE

START

After programming the oven for cooking, touch  or  to enter the time management menu.

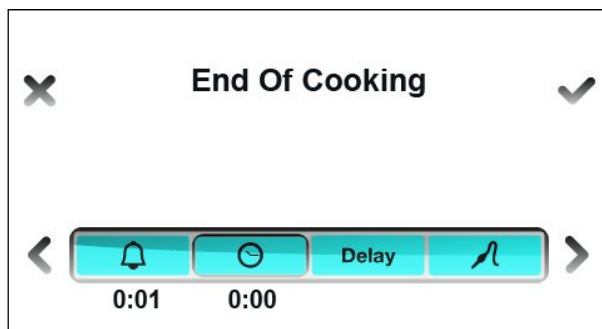

SET TIMER

This function is simply a minute minder: the timer can be used independently from cooking and it will not turn off the oven at the end of the set time. For the oven to shut off automatically, select END OF COOKING (see below).

Activate the TIMER 

Set the desired duration   (max 10 hours) and confirm 

Leave menu 

The display will show the countdown. The end of the countdown will be confirmed with a repeating tone. Tap any touch control area to stop tone.

Important!

COOKING WILL NOT STOP AT THE END OF THE COUNTDOWN. TURN THE OVEN OFF MANUALLY AND REMOVE FOOD FROM OVEN TO AVOID OVERCOOKING.

END OF COOKING

The oven will automatically turn off after the set cooking time has elapsed.

Activate END OF COOKING 

Set the desired duration   (max 10 hours) and confirm 

Leave menu 

The display will show the countdown. the oven will turn off at the end of the countdown and the display will show END OF COOKING – BUON APPETITO! The end of the countdown will be confirmed with a repeating tone. Touch any touch control area to stop tone.

MODIFY/CANCEL

Activate end of cooking menu and modify the time value.

Set time to 0:00 to cancel

Note

Cooking time is calculated from the end of preheating. During preheating the end of cooking time is not shown in the display.

It is not possible to set end of cooking when using the food probe. If a food probe temperature is set, the end of cooking will be deleted.

DELAY START The oven will start at a desired time.

Activate DELAY START

Delay

Set desired time before oven will turn on and confirm

Leave menu

The display will show the countdown. The oven will turn on at the end of a count down. The end of the countdown will be confirmed with a repeating tone.

Note

DELAY START can be combined with the END OF COOKING.

FOOD PROBE

The food probe is only available on XT models.

The food probe monitors the core temperature of the food during cooking and turns off the oven when the desired temperature is reached. It can be used ONLY with the following cooking modes:

- Convection
- Bake
- Convection bake
- Turbo
- Broil
- Convection Broil

Insert the food probe in the item to be cooked. For best results, insert the probe as close as possible to the center of the item and make sure it is not in contact with bones or fat. Improper placement of the probe could shut the oven off too early and result in uncooked food. With poultry, make sure the probe does not rest in a cavity.

Activate

Select the desired food temperature with and confirm

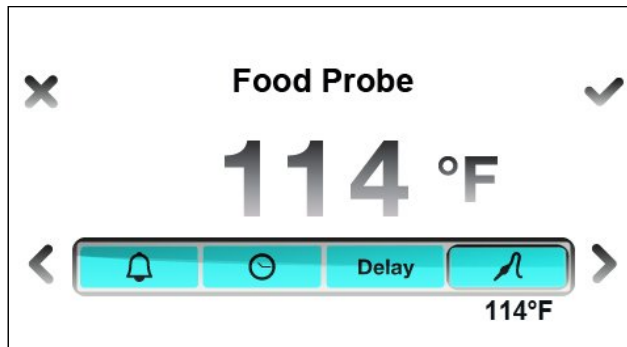

After the preheating sequence is completed, the display will show the message INSERT FOOD PROBE. CONTINUE?

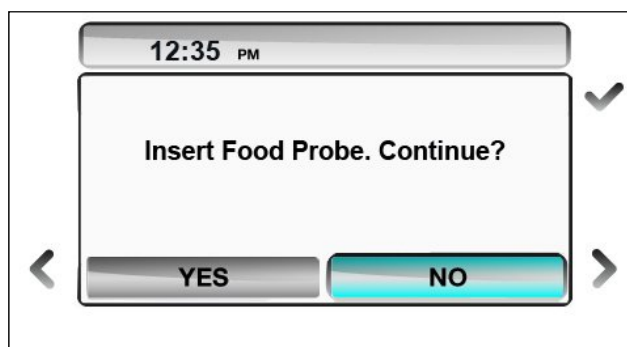

Connect the probe jack to the port located in the upper left side of the oven cavity.

Place the food in the oven and confirm 

The display will show the set temperature and the actual temperature measured by the probe. The oven will turn off when the desired food temperature is reached. The display will show END OF COOKING – BUON APPETITO! End of cooking will be confirmed with a tone. To stop tone tap any touch control area.

Note









Food probe temperature can be selected at any time while cooking.

If the probe jack is not inserted in its port, a message will appear on the display requiring confirmation of the probe insertion. Cooking will stop if the probe is not inserted. Select NO on the confirmation screen to continue cooking without probe.

Important

DO NOT LEAVE THE PROBE IN THE OVEN CAVITY WHEN NOT IN USE.

COOKING MODES GUIDE

MODE	DETAILS	USE FOR/TIPS
BAKE 	Bake and broil elements ON Convection OFF Temperature 100F - 500F Use lower 2 shelf levels.	Soufflés Meringues Angel food cakes Cream puffs Cookies Cakes Cheesecakes, Pies Quiches Baked potatoes
CONVECTION BAKE 	Bake element ON at full power Broil element ON at moderate power Convection fan ON Temperature 100F- 500F Use several levels at the same time. NOTE: As a general rule, the temperature of a recipe not designed for baking in a convection oven should be lowered by 20F (15C)	Cookies Cakes Breads Rising dough Cheesecake Pies Quiches Baked potatoes Casseroles
CONVECTION 	Convection fan and convection element ON Use several levels at the same time. Temperature 100F - 500F NOTE: As a general rule, the temperature of a recipe not designed for baking in a convection oven should belowered by 20 °F (15 °C.)	Gentle cooking of pastries, soufflés and cakes. At higher temperature use also for roasting meats and poultry.
TURBO 	Bake element ON at full power Convection element and fan ON at full power Temperature 100F – 500F Use shelf levels 2 and 3	Uniform cooking with strong heat from the bottom of pizza, focaccia and bread.
BROIL 	Broil element ON 4 power settings – LOW (1) to HIGH (4) The element is heated for the first 3 minutes at maximum power and then the power is reduced according to the selected power setting.	Brown food on the top side only. Turn food over if browning is required on both sides.
CONVECTION BROIL 	Broil element ON Convection fan ON 4 power settings – LOW (1) to HIGH (4) The element is heated for the first 3 minutes at maximum power and then the power is reduced according to the selected power setting.	Brown food on top and bottom side. This mode is preferred for browning food that is too delicate for turning such as fish. NOTE: The degree of browning on each side might be different.
DEFROST/DEHYDRATE 	In DEFROST mode only the fan is active to circulate air in the cavity. All heating elements are turned off. In DEHYDRATE mode the fan is on and the cavity is maintained at 100F.	Defrost food Dehydrate food, flowers, vegetables.
PROOFING 	Bake element ON at low constant heat power Fan on every 5 minutes to eliminate stagnant air. Use any shelf level.	For best results, place dough in bowl and cover with a clean towel.
WARMING 	Bake element at low to moderate power. Temperature 140/170/200F preset.	Use the warming program in Sabbath mode (S.M.) during religious observance.

BROIL / CONVECTION BROIL

The broil element operates on 4 different power levels.

The element is heated for the first 3 minutes at maximum power and then the power is reduced according to different desired effects.

Level 1 produce a mild browning of the food surface

Level 4 produce an intense irradiated heat that cause a fast browning of food.

Select the power level according to the desired effect on food.

Select BROIL to brown food on the top side only. This mode requires turning food if browning is required on both sides

Select CONVECTION BROILER to brown food slightly also on the bottom side. This mode is preferred for browning food on both sides that is too delicate for turning such as fish. The degree of browning on each side might be different

TIPS FOR BEST RESULTS – BROILING AND ROASTING

ADJUST TO DESIRE LEVEL OF ‘DONENESS’

FOOD	SHELF POSITION	COOKING MODE	TEMPERATURE	APPROXIMATE COOKING TIME	SUGGESTIONS
Ground beef patties, ½” thick	6	Broiler Convection Broiler	LEV 4	15 to 20 minutes	Broil until not pink in center
T-Bone steak	6	Broiler Convection Broiler	LEV 4	12 to 20 minutes	Broil until done to desired level
Flank steak	6	Broiler Convection Broiler	LEV 4	12 to 20 minutes	Broil until done to desired level
Eye of round roast	5	Bake Convection bake	330°	20 to 25 min per pound	Small roasts require longer time per pound; reduce time using Convection Bake
Loin roast	5	Bake Convection bake	330°	20 to 25 min per pound	Cook until juices are clear
Boneless skinless chicken breasts	6	Broiler Convection Broiler	LEV 3	20 to 25 minutes	Cook until juices are clear
Chicken thighs	5	Broiler Convection Broiler	LEV 3	25 to 30 minutes	Remove skin and cook until juices are clear
Half chicken	5	Broiler Convection Broiler	LEV 4	30 to 45 minutes	Turn with tongs and cook until juices are clear
Roast chicken	4	Bake Convection bake	350°	75 to 90 minutes	Reduce time using Convection Bake. Time may vary if stuffed.
Turkey	4	Bake or Convection bake	330°	20 to 25 min per pound	Reduce time using Convection Bake. Time may vary if stuffed.

TIPS FOR BEST RESULTS - BAKING

CHECK PACKAGE DIRECTIONS

FOOD	PAN SIZE	TEMPERATURE	COOKING TIME (minutes)	LEVEL
Cookies	12"x15" Cookie Sheet	370°	8 to 12	2..5
Layer Cakes	8"or 9"Round	350°	25 to 35	2..5
Sheet Cakes	9"x13" Pan	350°	30 to 40	2..5
Bunt Cakes	12 Cup	320°	60 to 75	2..5
Brownies, Bar Cookies	9"x9" Pan	320°	20 to 25	2..5
Biscuits	12"x15" Cookie Sheet	420°	10 to 15	2..5
Quick Bread	8"x4" Loaf Pan	350°	55 to 70	2..5
Muffins	12 cup Muffin Pan	420°	14 to 19	2..5
Fruit Pies	9" Diameter	420°	35 to 45	2..5
Fruit Cobblers	9"x9" Pan	400°	25 to 30	2..5
Yeast Bread	8"x4" Loaf Pan	370°	25 to 30	2..5
Dinner Rolls	9"x13" Pan	400°	12 to 18	2..5
Cinnamon Rolls	9"x13" Pan	370	25 to 30	2..5
Yeast Cake	12"x15" Cookie Sheet	400°	20 to 30	2..5

TIPS FOR BEST RESULTS - WARMING

FOOD	TEMPERATURE
Beef	150°F (70°C)
Bacon	200° -225°F (90 - 110°C)
Biscuits and Muffins (covered)	175°-200°F (80 – 90°C)
Casserole (covered)	175°-200°F (80 – 90°C)
Fish and Seafood	175°-200°F (80 – 90°C)
Deep Fried Foods	200° -225°F (90 - 110°C)
Gravy or Cream Sauces (covered)	175°F (80°C)
Lamb and Veal Roasts	175°-200°F (80 – 90°C)
Pancakes and Waffles (covered)	200° -225°F (90 - 110°C)
Potatoes Baked	200°F (110°C)
Mashed (covered)	175°F (80°C)
Pies and Pastries	175°F (80°C)
Pizza (covered)	225°F (110°C)
Pork	175°-200°F (80 – 90°C)
Poultry (covered)	175°-200°F (80 – 90°C)
Vegetables (covered)	175°F (80°C)

TIPS FOR BEST RESULTS - DEHYDRATE

FOOD	PREPARATION	APPROXIMATE TIME (hrs)	DONE WHEN...
Apples	Cut in ¼" slices and dip in 1/4 cup lemon juice + 2 cups water solution	11-15	Slightly pliable
Bananas	Cut in ¼" slices and dip in 1/4 cup lemon juice + 2 cups water solution	10-15	Soft, pliable
Cherries	Wash and towel dry. Remove pits	10-15	Pliable, leathery, chewy
Orange peels and slices	Peel and cut in 1/4" slices	Peels: 2-4 Slices: 12-16	Orange peel: dry and brittle. Orange slices: skins are dry and brittle, fruit is slightly
Pineapple rings	Towel dry	Canned: 9-13 Fresh: 8-12	Soft and pliable
Strawberries	Wash and towel dry. Cut in 1/2" slices. Place skin (outside) down on rack	12-17	Dry, brittle
Red peppers	Wash and towel dry. Remove stems, chop coarsely about 1" pieces	16-20	Leathery with no moisture inside
Mushrooms	Wash and towel dry. Cut off stem end. Cut into 1/8" slices	7-12	Tough and leathery, dry
Tomatoes	Wash, drain well, and towel dry. Cut in 1/8" slices.	16-23	Dry, brick red colour
Oregano, sage, parsley, thyme, fennel	Rinse and dry with paper towel	3-5	Crisp and brittle
Basil	Use basil leaves 3 to 4 inches from top. Spray with water, shake off moisture and pat dry	3-5	Crisp and brittle

ASSISTANT FUNCTION

Available on XT models only

Developed with the help of Italian professional chef consultant Roberto Carcangiu, Bertazzoni's exclusive ASSISTANT function is a revolutionary system for upgrading oven cooking in the home. The ASSISTANT is pre-programmed with finely calibrated sets of cooking modes, temperatures and times sequences for each type of food. The system does not provide recipes – those are yours to choose from. The ASSISTANT will simply 'pilot' the oven to help you make the best of your oven recipes.

Enjoy selecting the sequences already stored in the ASSISTANT that best suit your own style of cooking and culinary taste. After you have familiarized with them, you will be able to build new sequences of your own creation and store them for future use.

The ASSISTANT is available on XT models only together with a food probe for temperature control.

ASSISTANT MENU



MANAGE - Selected the food type, weigh/size, type of cooking and desired finish and let the Assistant oversee the cooking until your dish is perfect.



SAVE – After you cook a perfect dish, name the cooking sequence and let the Assistant store it for future use.



RETRIEVE – Retrieve a previously stored set and let the ASSISTANT manage the oven according to the instructions you selected for that dish.



BREAD



CAKES AND PASTRY



FISH



MEAT



PASTA



PIZZA















POULTRY



VEGETABLES

START

Activate the oven by touching any control area for 2 seconds.

- Start programming with 
- Select ASSISTANT  with   or with right knob and confirm 
- Select MANAGE  with   and confirm 
- Select TYPE OF FOOD with   and confirm 

Selected food categories will guide you through the selection of additional parameters (e.g. for meat: weight, type of cut, food probe temperature). Follow the directions on the display, select the appropriate parameters and confirm.

The oven will begin pre-heating and signal the end of the pre-heating cycle with a tone. Insert the food in the oven only after the pre-heating is complete.



The display will show the time remaining until the end of the cooking sequence.

The oven will turn off at the end of the cooking cycle. The display will show END OF COOKING – BUON APPETITO! End of cooking will be confirmed with a tone.

Important:

COOKING WILL CONTINUE WITH RESIDUAL HEAT. REMOVE THE DISH FROM THE OVEN IMMEDIATELY TO AVOID OVERCOOKING.

FOOD PROBE

If the cooking sequence requires the use of the food probe, the display will ask you to input the desired food temperature (lower = rare, higher = well done). Once the pre-heating cycle is completed, the display will remind you to insert the food probe. Connect the food probe jack to the appropriate port in the oven cavity at the end of preheating. The cooking sequence will start only after confirmation that the food probe has been inserted.

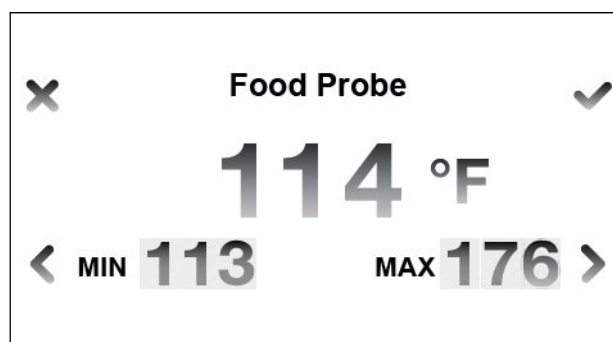

When using the food probe, the display will show the food probe temperature (actual and target) instead of the remaining time until the end of cooking.

The oven will turn off when the food temperature measured by the probe reaches the desired level. The display will show END OF COOKING – BUON APPETITO! End of cooking will be confirmed with a tone.

Important:

COOKING WILL CONTINUE WITH RESIDUAL HEAT. REMOVE THE DISH FROM THE OVEN IMMEDIATELY TO AVOID OVERCOOKING.

STOP/MODIFY

To STOP cooking tap  and confirm.

It is not possible to change cooking mode, temperature or duration while cooking with the ASSISTANT function. If additional cooking is needed, operate the oven in manual mode until the desired result is obtained.

Important

Pre-programmed sequences have been calibrated for cooking food starting from room temperature. If using frozen food for a dish, defrost it before starting a sequence.

Note :

In low temp roasting mode, food is baked at a very low temperature then requiring long cooking time. Baking time can last up to 5/6 hours, according to food dimensions.

In assistant cooking mode, the time is calculated from the end of preheating. Make sure to introduce food in the oven as soon as the preheating time is finished, otherwise the cooking time can result too short.

All cooking methods refer to fresh food, except where indicated. For frozen food, refer to your standard procedure

ASSISTANT FUNCTION - OPTIONS CHART

Food	Preparation	Food probe	Pre-programmed cooking time*
Meat	Traditional Roasting	yes	
	Low Temp. Roasting	yes	
	Braising		90 min.
	Slow cooking	yes	
	Oven Fried		6 min.
Poultry	Traditional Roasting	yes	
	Slow cooking	yes	
Fish	Traditional Roasting	yes	
	Oven Fried		12 min.
	Grilled - food temp. probe	yes	
	Grilled – manual		7 min.
Cakes	Rising pastry dough		35 min.
	Shortbread dough		25 min.
Bread	Manual		22 min.
	Food temp. probe	yes	
Pizza	Homemade pizza		14 min.
Pasta	Frozen au gratin	yes	
	Fresh au gratin		35 min.
Vegetables	Stew / Sauté		20 min.
	Grilled		7 min.
	Roasted potatoes		50 min.

* Time indicated excludes pre-heating

SLOW COOKING

Slow cooking allows cooking of very large pieces of meat and poultry (over 4Kg. or 8,8Lbs) for several hours at a very low temperature. This cooking mode does not end when the temperature set on the food probe is reached, but the food is then continuously kept at this temperature. The temperature shown on the food probe will then continuously be adjusted (-15F +0)once the set valve has been reached. A manual switch off of the oven is then required. A cooking time of 12 hours is suggested. The program is automatically switched off after 24h.

CUT TYPE

Cut type	Type of meat
Less tender	Beef chuck
	Beef brisket
	Corned beef
	Short ribs
	Pork shoulder
	Lamb shank
	Pork blade roast
	Beef tenderloin
Tender	Prime rib
	Pork tenderloin
	Leg of lamb
	Chicken legs/thighs

SAVE

The ASSISTANT stores your latest cooking sequence for future use.

It is possible to save in the memory the last cooking sequence performed in each oven. In this case enter in the assistant mode from the oven cavity where You have performed the cooking sequence You would like to save.

Select ASSISTANT  with   or with right knob and confirm 



Select SAVE  with   and confirm 

The display will show the last cooking sequence performed, indicating the set of cooking modes, temperatures and times used for the cycle.



Confirm 

Select FOOD CATEGORY and confirm 

Enter a name for this cooking sequence - scroll through the keyboard with  

and confirm each letter with 

NOTE: scrolling accelerates by keeping the finger on the touch area.



Confirm with 

Touch  to leave this menu without saving the sequence.

After saving a sequence, the display will return to the main ASSISTANT menu.

Important

The memory can store up to a maximum of 32 personalized cooking sequences in addition to those pre-programmed. When the memory is full and you attempt to store another cooking sequence, a message will prompt you to delete one of the previously stored sequences.

The interface will eliminate steps that are not significant for cooking results, such as functions used for less than 1 minute.

A maximum of 4 different cooking steps (combination of function/temperature/time) can be recorded in a sequence.

RETRIEVE

To retrieve a previously stored personal sequence follow these simple steps.

Once saved, a personal cooking sequence can be retrieved from both oven cavities, as the file of save cooking modes is common for both cavities.

For this reason, deleting or modifying a personal cooking sequence will also affect the file for both cavities.

Select ASSISTANT  with < > or with right knob and confirm ✓

Select RETRIEVE  with < > and confirm ✓

Select FOOD CATEGORY and confirm ✓

Select a stored sequence and confirm ✓

You will have the following options:

- START: will immediately start the cooking sequence.
- MODIFY: allows to modify food category and name associated to a personal cooking sequence
- DELETE: delete the selected cooking sequence. Confirmation is required.

Note:

if no cooking sequence is saved an empty menu will be displayed.



SABBATH MODE

This special program is designed for religious observances.

START

Activate the oven by touching any control area for 2 seconds.

Start programming with 

Select WARMING with   or with right knob and confirm 



Select S.M. with   and confirm 

The oven will turn on and pre-heat until the temperature of 200F is reached. Then, the temperature will be held constant until the oven is switched off. Opening of the door will not cause an immediate re-heating of the oven: the heating will continue according to a set procedure independent from use.

The oven lights will not turn on in Sabbath Mode even if the door is open.

MODIFY/STOP

To modify cooking mode:

- DESIGN SERIES OVEN: Scroll COOKING MODES  
- PROFESSIONAL SERIES OVENS: use the cooking mode knob (right)

Turn off the oven with 

SELF-CLEANING CYCLE

DESCRIPTION	<p>In the self-cleaning cycle, the oven cavity is heated to very high temperatures to burn off any residue on the oven interior. After the cleaning cycle, any burnt off residue is transformed to ash and can be easily wiped out with a damp sponge.</p> <p>Spilled fruit juices may permanently discolour surfaces. This discoloration is permanent but will not affect the efficiency of the enamel.</p> <p>If the oven is not cleaned regularly, debris may become extremely difficult to remove even with the CLEAN function.</p>
DOOR LOCK	<p>Due to the extremely high temperature reached in the self-cleaning function, the door will automatically lock after 1 minute. The lock will release once the cycle has ended and the oven temperature has dropped below 500F (260C).</p>
PREPARE	<p>Before starting the CLEAN function:</p> <ul style="list-style-type: none">- Remove large pieces of debris and grease deposits from the interior of the oven cavity. Debris and grease can ignite at high temperatures.- Remove all accessories from the oven. The high temperature reached during the cycle will damage the accessories.
SPECIAL CONDITIONS	<p>It is possible to activate the cleaning cycle on one of the cavity at a time. During the clean cycle the other cavity will be completely switched off, the door will not be locked but the oven lights will not work.</p> <p>It will not be possible to switch the interface display to the other oven.</p> <p>It will not be possible to activate a cleaning cycle if the other cavity is in operation.</p>
START	<p>CON models: Select Clean in the COOKING modes menu</p> <p>PRO models: set both knobs to CLEAN. NOTE: if either knob is moved from the clean position, the cycle is aborted.</p> <p>Select REGULAR or ECO cleaning mode. The regular cycle lasts longer than the ECO cycle and therefore uses more energy.</p> <p>Confirm that all accessories have been removed from oven cavity to start the cleaning cycle.</p> <p>The oven door will lock for the duration of the cycle and it will not be possible to operate the oven.</p> <p>During the clean cycle the cooling fans are constantly in operation.</p> <p>The end of the cleaning cycle will be confirmed with a tone.</p> <p>The oven door will remain locked until the oven temperature falls below 500F (260C).</p>
STOP	<p>CON models: touch OFF</p> <p>PRO models: move either knob from clean position.</p>
CAUTION	<p>The interior of the oven will still be at high temperature when the automatic lock is released – USE MAXIMUM CAUTION TO AVOID BURNS.</p> <p>If "SELF CLEAN" is accidentally selected, shut off the oven and wait for the oven temperature to drop for the door lock to release.</p>

CLEANING THE OVEN

FRONT

Clean spills from the front of the appliance immediately. Spills may cause discoloration of the glass and steel surfaces.

Clean the front of the appliance with a clean sponge or cloth, liquid dish soap and warm water. Alternatively, use a clean, damp microfiber cloth and then dry with a soft cloth.

All surfaces are vulnerable to scratching. Scratches can lead to shattering of the glass surface.

All surfaces can become discoloured or changed if they come into contact with unsuitable cleaning agents.

In PRO model the display is protected with a transparent glass which is very delicate. Avoid contact with cleaning agents. Do not rub the surface. Swipe delicately with a mild cleaning agent and dry with a clean cloth.

INTERIOR

Caution: Danger of burns! Allow the oven to cool before cleaning.

Clean the oven surface with a solution of hot water, liquid dish soap and a sponge or soft nylon brush.

Do not use abrasive cleaning agents, hard brushes, metal scouring pads, steel wool, knives or other abrasive materials.

Avoid cleaning the gasket around the interior (sealing the door glass pane). It is made from glass fiber and will get damaged if rubbed or scrubbed.

Do not use oven spray on any part of this oven.

Tips

The porcelain enamel finish of the cavity is acid resistant, but not acid proof. Acidic food, such as citrus juices, tomatoes, rhubarb, vinegar, alcohol or milk, should be wiped off and not allowed to bake onto the porcelain during the next use.

Remove the oven racks when cleaning the interior of the oven.

The heating elements in the oven do not require cleaning; the elements burn themselves clean when the oven is in use. Elements are permanently connected. It is not necessary to clean the broiler shield above the broil element.

To avoid surface damage from cleaning, do not use any of the following:

- cleaning products that contain washing soda, ammonia, acids, or chlorine
- lime removers
- scouring cleansers, e.g., scouring powder, scouring liquid, pumice stones
- solvent-based cleansers
- stainless steel cleaners
- dishwasher detergents
- oven sprays
- glass cleaners
- scouring sponges or brushes, such as pot scrubbers
- sharp metal scrapers

FOOD PROBE

Wash with soapy water and a sponge. Rinse under running water. Do not leave the probe submerged in water. Do not clean the food probe in the dishwasher.

ACCESSORIES

Wash with soapy water and a sponge. Rinse under running water.

REPLACING THE OVEN LIGHTS

WARNING!

Disconnect power before servicing unit.

To replace the oven light bulb, remove the protection cap. It is not necessary to remove the rack supports.

NOTE: Touching the bulb with fingers may cause the bulb to burn out. Always use protective gloves or use a cloth to remove the bulb.

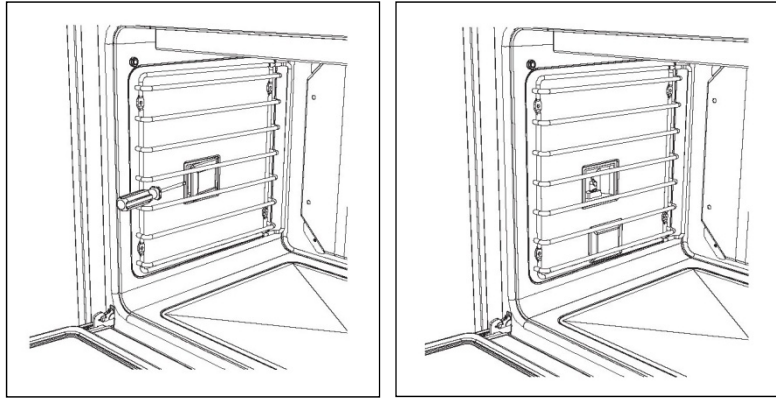

TROUBLESHOOTING GUIDE

OVEN PROBLEM	POSSIBLE CAUSES AND/OR REMEDY
Oven does not function	Range is not connected to electrical power. Ask a professional to check power circuit breaker, wiring and fuses.
Self-clean cycle does not activate	Door is not shut tight and door latch cannot lock
Door does not open	Oven is still in self-clean mode. Door latch will release when safe temperature is reached.
Oven light does not work	Light bulb is burned out. Oven is not connected to power. Clean cycle is on.
Oven door is locked and will not release after cooling	Turn the oven off at the circuit breaker and wait 5 minutes. Turn breaker back on. The oven should reset itself and will be operable.
Oven is not heating	Check the circuit breaker or fuse box to your house. Make sure there is proper electrical power to the oven. Make sure the oven temperature has been selected.
Oven light is not working properly	Replace or reinsert the light bulb if loose or defective.
Oven light stays on	Check for obstruction in oven door. Check to see if hinge is bent.
Cannot remove light cover	There may be debris/spillage around the lens cover. Wipe lens cover area with a clean dry towel prior to attempting to remove the lens cover.
One cavity is not working	Other oven is in self cleaning mode this is normal, wait for termination of the cleaning cycle
One cavity is not working but other cavity is working regularly	a problem in the involved cavity has occurred. Contact after sale service with the indication of the error message shown on the display.

Specific error messages may appear in case of malfunction. Call after sale service and provide the information that appear in the display for a quick and accurate diagnosis.



BERTAZZONI SpA
Via Palazzina 8
42016 Guastalla RE
ITALY

WWW.BERTAZZONI-ITALIA.COM

SPARE PARTS LIST

NUM.	COMPONENT	DESCRIPTION	EXPLODED VIEW	FD30CONXE	FD30CONXT	FD30PROX	FD30PROXE	FD30PROXT
				800584	800584	800584	800584	800584
1	409063	OVEN TOUCHSCREEN SELECTOR BOARD		1	1			
1	310494	USER MANUAL		1	1	1	1	1
1	310495	USER MANUAL		1	1	1	1	1
1	601444	WIRING		1	1	1	1	1
1	601665	WIRING		2	2	4	4	4
1	601673	WIRING				2	2	2
1	601674	WIRING		4	4	4	4	4
1	601676	MEAT PROBE WIRING			2			2
1	601677	POWER BOARD INTERFACE WIRING		2	2	2	2	2
1	601678	DOUBLE OVEN COMMUTATOR WIRING		1	1			
1	601679	COOLING FANS WIRING		2	2	2	2	2
1	601691	MEAT PROBE WIRING			2			2
1	601692	WIRING		2	2	2	2	2
30	202797	OVEN RESISTANCE FASTENING CLAMP		6	6	6	6	6
38	306003	THERMOSTAT CLIP		4	4	4	4	4
104	202729	MOTORFAN FLAP		2	2	2	2	2
105	202724	UP SUPPORT FOR AXIAL COOLIN FAN		1	1	1	1	1
105	202724	UP SUPPORT FOR AXIAL COOLIN FAN		1	1	1	1	1
106	202723	DOWN SUPPORT FOR AXIAL COOLIN FAN		1	1	1	1	1
106	202723	DOWN SUPPORT FOR AXIAL COOLIN FAN		1	1	1	1	1
117	150009	PROTECTION FOR VENTILATED OVEN		2	2	2	2	2
119	941014	GRID FOR OVEN		2	2	2	2	2
120	101048	BLACK OVEN DRIP TRAY		1		1	1	
120	101441	BLACK OVEN DRIP TRAY			1			1
138	202735	DISHWARMER BOTTOM		1	1	1	1	1
166	50008	INSIDE OVEN DOOR		2	2	2	2	2
311	301122	SCREW 4,2X30		2	2	2	2	2
313	301073	SCREW 5MAX10 TCT			2			
313	301073	SCREW 5MAX10 TCT			2			
329	309160	INSIDE DOOR SPACER		12	12	12	12	12
329	309161	INSIDE DOOR SPACER				4	4	4
330	309035	FIXING BUSH FOR RETAINER HEADPIECE		4	4	4	4	4
388	301133	SCREW 4,2X13		98	94	116	112	112
389	301109	SCREW M5X32 FOR HANDLE				4		
440	402167	CATALYST		2	2	2	2	2
441	404507	SIDE GRID FOR OVEN		4	4	4	4	4
442	404508	GRID FOR OVEN		2	2	2	2	2
443	404497	GRID FOR TRAY		1		1	1	1
443	404512	GRID FOR TRAY			1			4
444	405095	OVEN DOOR HINGE FIX PART		4	4	4	4	4
446	405094	OVEN DOOR HINGE		4	4	4	4	
470	404509	GRID FOR OVEN		2	2	2	2	2
568	508039	PROBE		2	2	2	2	2
573	609001	MEAT PROBE			2			2
584	609002	MEAT PROBE CONNECTION			2			2
608	309159	ANTI-SHORT BUSHING AS5		2	2	2	2	2
609	309151	CORE HITCH		4	4	4	4	4
610	603031	LOOK DOOR MOTOR		2	2	2	2	2

611	603030	OVEN CONVECTION FAN		4	4	4	4	4
612	603019	COOLING FAN		2	2	2	2	2
612	603019	COOLING FAN		2	2	2	2	2
613	606079	OVEN RESISTANCE 2100W 230V		2	2	2	2	2
614	606080	RESISTENCE 3400W 240V		2	2	2	2	2
615	606090	CIRCULAR HEATER 3300W		4	4	4	4	4
623	608057	OVEN BULB WITH HOLDER		4	4	4	4	4
624	309158	SQUEEZE CONNECTORS L423		1	1	1	1	1
641	602056	COMMUTATOR 11+0				2	2	2
642	602047	TEMPERATURE SELECTOR				2	2	2
648	607027	TERMINAL SEPARATOR		2	2	2	2	2
658	409061	DISPLAY + LOGIC CARD						1
658	409067	DISPLAY + LOGIC CARD		1				
658	409062	DISPLAY + LOGIC CARD			1	1		
658	409065	DISPLAY + LOGIC CARD					1	
659	409058	LOGIC CARD		2	2	2	2	2
662	602049	THERMOSTAT		2	2	2	2	2
947	403343	HANDLE TERMINAL				4		
1041	4010219	ELECTRIC KNOB				4	4	4
1406	403534	OVEN DOOR HANDLE		2			2	
1406	403535	OVEN HANDLE			2			
1406	403531	OVEN DOOR HANDLE				2		
1406	403519	OVEN HANDLE						2
1407	406463	OVEN DOOR GLASS				2	2	2
1407	406469	OVEN DOOR GLASS		1	1			2
1407	406471	OVEN DOOR GLASS NO BRAND NAME		1	1			2
1409	411128	GLASS OVEN GASKET		2	2	2	2	
1411	411127	GASKET FOR OVEN FRONT		2	2	2	2	
1414	602050	THERMOSWITCH		2	2	2	2	2
1415	602051	THERMOREGULATOR		2	2	2	2	2
1415	602051	THERMOREGULATOR		2	2	2	2	2
1421	406462	INTERNAL OVEN GLASS		6	6	6	6	6
1427	406461	GLASS CONTROL PANEL					1	1
1428	406474	CONTROL PANEL GLASS		1	1	1		
1508	410809	STAINLESS STEEL OVEN DOOR		2	2			
1508	410765	STAINLESS STEEL OVEN DOOR				2	2	
1601	410812	CONTROL PANEL FRAME		1	1			
1602	211124	CONTROL PANEL				1	1	1
1605	402446	INSULATING FOR LAMP		4	4	4	4	4
1614	202765	UP BACK PANEL		1	1	1	1	1
1614	202766	DOWN BACK PANEL		1	1	1	1	1
1615	202761	CONTROL SUPPORT		1	1			
1615	202722	CONTROL SUPPORT				1	1	1
1639	202733	VERTICAL VENT		4	4	4	4	4
1677	200469	FRONT PANEL INOX		2	2	2	2	2
1687	202728	UNDER OVEN CARTER		1	1	1	1	1
1690	202763	UNDER OVEN CARTER FOR OVEN UP		1	1	1	1	1
1712	200493	INNER GLASSES FRAME RIGHT		4	4	4	4	4
1861	6010014	TUBE		1	1	1	1	1
2019	202736	SIDE CHASSIS		4	4	4	4	4
2023	202734	REAR SIDE CHASSIS		2	2	2	2	2
2028	202738	UP SIDE CHASSIS		1	1	1	1	1
2098	202727	ELECTRIC RESISTANCE COMPARTMENT		2	2	2	2	2

2130	202726	GRILL PROTECTION		2	2	2	2	2
2147	150008	FRONTAL SCREEN GRILL		2	2	2	2	2
2184	202730	LAMPS WOOL FASTENING CLAMP		4	4	4	4	4
2185	1080053	FIXING DYSPLAY		1	1			
2185	202743	FIXING DYSPLAY				1	1	1
2301	202803	SUPPORT LOGIC CARD		2	2	2	2	2
2306	202764	EQUERRE SUPPORT FERME CABLE		1	1	1	1	1
2375	1080011	SQUARE FOR HANDLE DOOR FIXING				4	4	4
2381	202725	FLAP FASTENER		8	8	8	8	8
2404	202741	CARTER CATALYST		2	2	2	2	2
2406	202572	DOOR FOR INSPECTION LOOK DOOR		2	2	2	2	2
2409	201187	TERMINAL SEPARATOR DOOR		5	5	5	5	5
2410	202742	LOOK DOOR CARTER		2	2	2	2	2
2501	1080010	SCREEN FIBER GLASS				2	2	2
2521	1080039	PROTECTION GLASS FIBER INSIDE O. DOOR		2	2	2	2	2
3201	402444	GLASS FIBER FOR MUFFLE		2	2	2	2	2
3215	402443	UP/DOWN GLASS FIBER FOR MUFFLE		4	4	4	4	4
3220	402445	BACK FIBER GLASS FOR MUFFLE		2	2	2	2	2
3240	402442	GLASS FIBER FOR OVEN DOOR				4	4	4
3265	402441	GLASS FIBER FOR OVEN DOOR		2	2	2	2	2
3500	604075	SWITCH		2	2	2	2	2
3500	604075	SWITCH		2	2	2	2	2
3551	604076	SWITCH BLADE		2	2	2	2	2
3551	604076	SWITCH BLADE		2	2	2	2	2
3552	604077	SWITCH SUPPORT		2	2	2	2	2
3552	604077	SWITCH SUPPORT		2	2	2	2	2
4301	200486	SIDE PROFILE		1	1			
4301	200471	SIDE PROFILE					1	1
4302	200487	SIDE PROFILE		1	1			1
4302	200472	LEFT SIDE PROFILE					1	
4303	200489	DOWN SIDE PROFILE						1
4303	200491	DOWN SIDE PROFILE		1	1	1		
4304	200490	DOWN SIDE PROFILE						1
4304	200492	DOWN SIDE PROFILE		1	1	1		
4303	200489	DOWN SIDE PROFILE				1	1	
4304	200490	DOWN SIDE PROFILE				1	1	
4403	200470	DRIP DRAIN PROFILE		1	1	1	1	1
4405	200507	DRIP DRAIN PROFILE		1	1			
4405	200488	DRIP DRAIN PROFILE				1	1	1
4529	201213	PROFILE		2	2	2	2	2
4531	202768	PROFILE		1	1	1	1	1
4548	1080052	SQUARE FOR HANDLE DOOR FIXING		1	1			
4548	1080052	SQUARE FOR HANDLE DOOR FIXING		1	1			
4550	202767	OVEN OVERLAPPING RAIL		2	2	2	2	2

★THESE PARTS CAN ONLY BE SUPPLIED IN PRE-ASSEMBLED KIT, NOT AS SINGLE PARTS

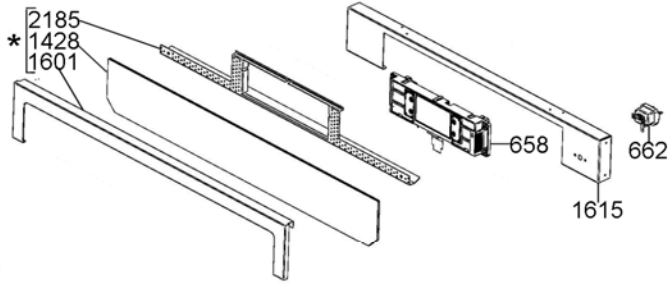

★THESE PARTS CAN ONLY BE SUPPLIED IN PRE-ASSEMBLED KIT, NOT AS SINGLE PARTS

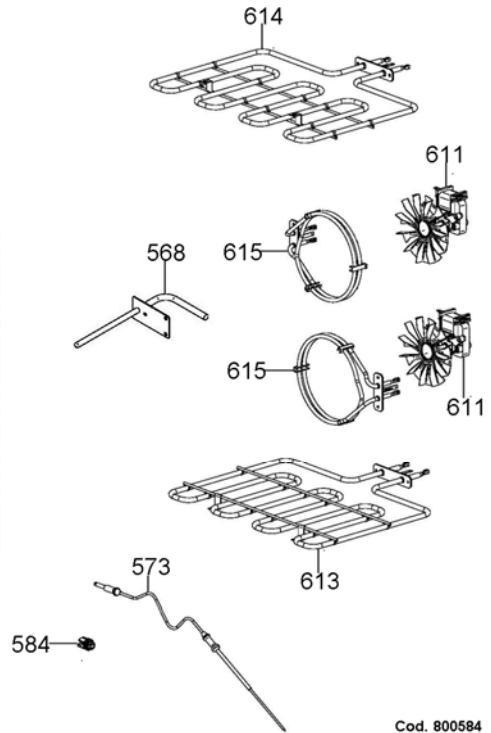
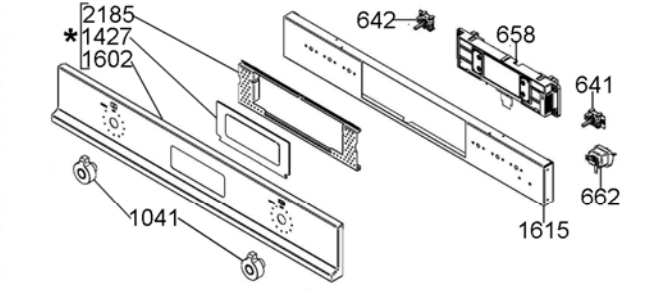

Cod. 800584

★THESE PARTS CAN ONLY BE SUPPLIED IN PRE-ASSEMBLED KIT, NOT AS SINGLE PARTS

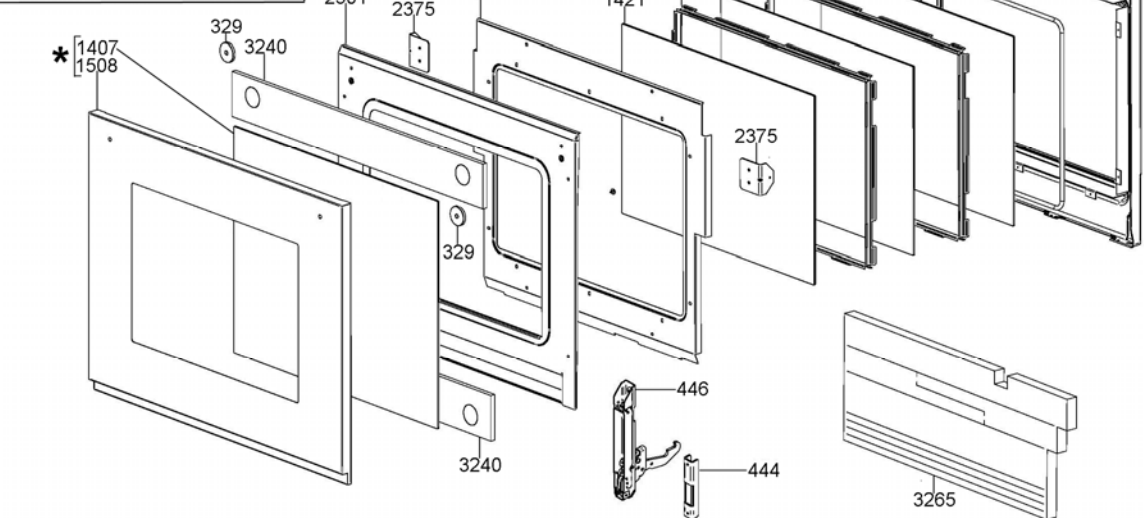
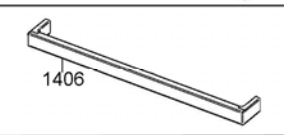
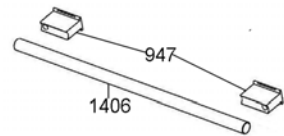

Cod. 800585

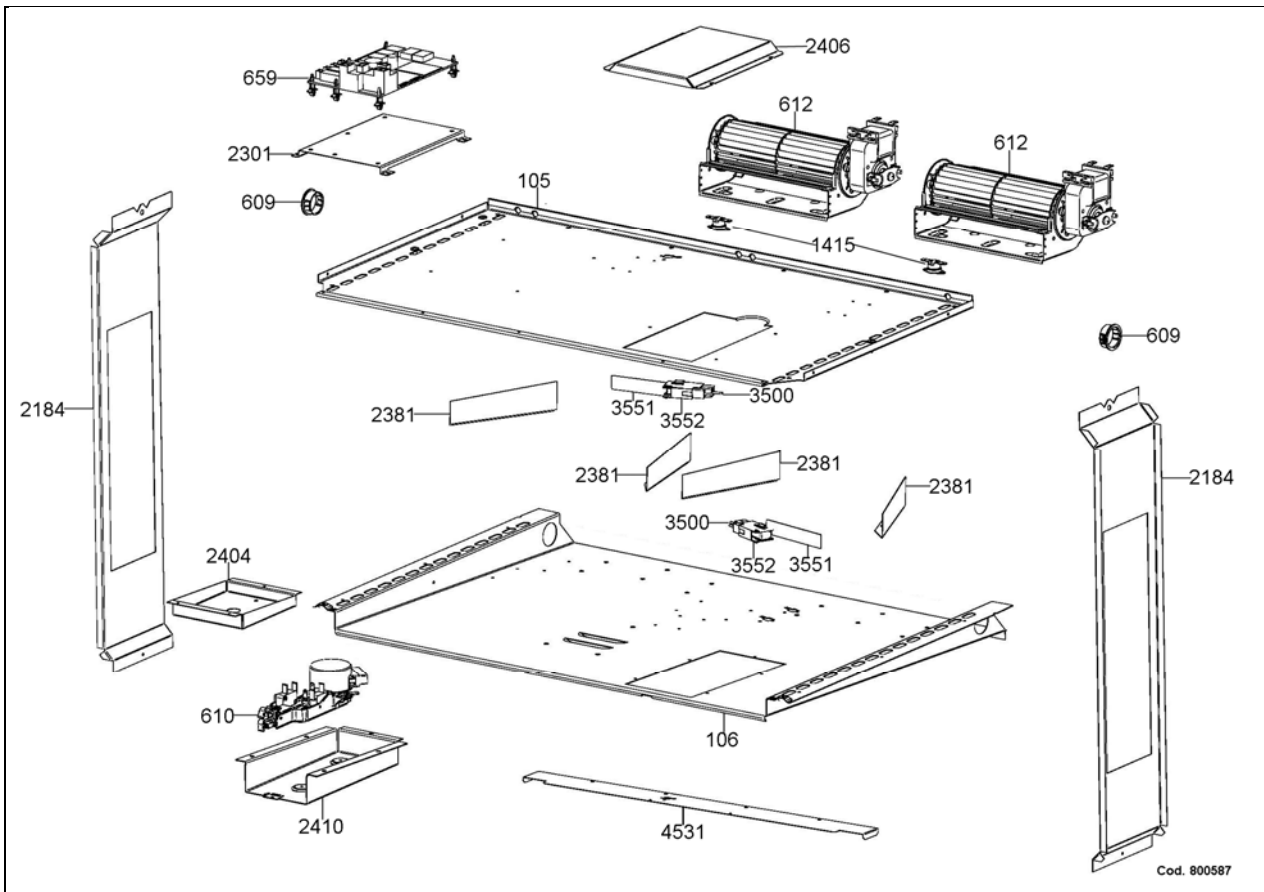

* THESE PARTS CAN ONLY BE SUPPLIED IN PRE-ASSEMBLED KIT, NOT AS SINGLE PARTS

