

SUMMIT

REFRIGERATOR WITH BOTTOM FREEZER

CP171 Series



User's Manual

FELIX STORCH, INC.

770 Garrison Avenue

Bronx, NY 10474

IMPORTANT SAFEGUARDS

WARNING: Keep ventilation openings in the appliance's cabinet or in the built-in structure clear of obstruction.

WARNING: Do not use other **mechanical devices** or other means to accelerate the defrosting process than those recommended by the manufacturer.

WARNING: Do not damage the refrigerant system.

WARNING: Do not use **electrical appliances** inside the refrigerated storage compartment unless they are of a type recommended by the manufacturer.

WARNING: Do not expose the appliance to rain.

WARNING: This appliance is not intended for use by young children or infirm persons unless they have been adequately supervised by a responsible person to ensure that they can use the appliance safely. Young children should be supervised to ensure that they do not play with the appliance.

WARNING: *Risk of child entrapment.*

Before you throw away your old refrigerator or freezer:

- Take off the doors.
- Leave the shelves in place so that children may not easily climb inside.

Always keep the keys in a separate place and out of reach of children.

Before servicing or cleaning the appliance, disconnect the electrical power supply.

If the power supply cord is damaged, it must be replaced by the manufacturer, its service agent, or similarly qualified persons in order to avoid a hazard.

Frost formation on the interior evaporator wall and upper parts is a natural phenomenon. Therefore, the appliance should be defrosted during normal cleaning or maintenance.

Directions for replacing the light bulb are included in the instructions.

Please note that changes to the appliance construction will cancel all warranty and product liability.

Table of Contents

<i>Important Safeguards</i>	2
<i>Before your first use</i>	3
<i>Location of Parts</i>	4
<i>Electrical Connection</i>	5
<i>Installation and Start-up</i>	6 - 8
<i>Reversing the Doors</i>	9
<i>Operation and Function</i>	10 - 12
<i>Defrosting</i>	13
<i>Cleaning and Maintenance</i>	14
<i>Disposal</i>	14
<i>Troubleshooting</i>	15
<i>Warranty</i>	16

Before your first use

This appliance is for indoor use only.

On receipt, check to ensure that the appliance has not been damaged during transport. Transport damage should be reported to the local distributor before the appliance is put to use.

Wash the cabinet and inner lining with a mild unscented detergent and wipe it dry. Do not use scouring powder, steel wool or similar abrasive material.

Before operating your new appliance, please read the following instructions carefully as they contain important information on safety, installation, operation and maintenance. Keep the instructions for future reference.

If during transport the appliance has been laid down, or if it has been stored in cold surroundings (colder than 41°F, or 5°C), it must be allowed to stabilize in an upright position for at least an hour before being switched on.

Location of Parts

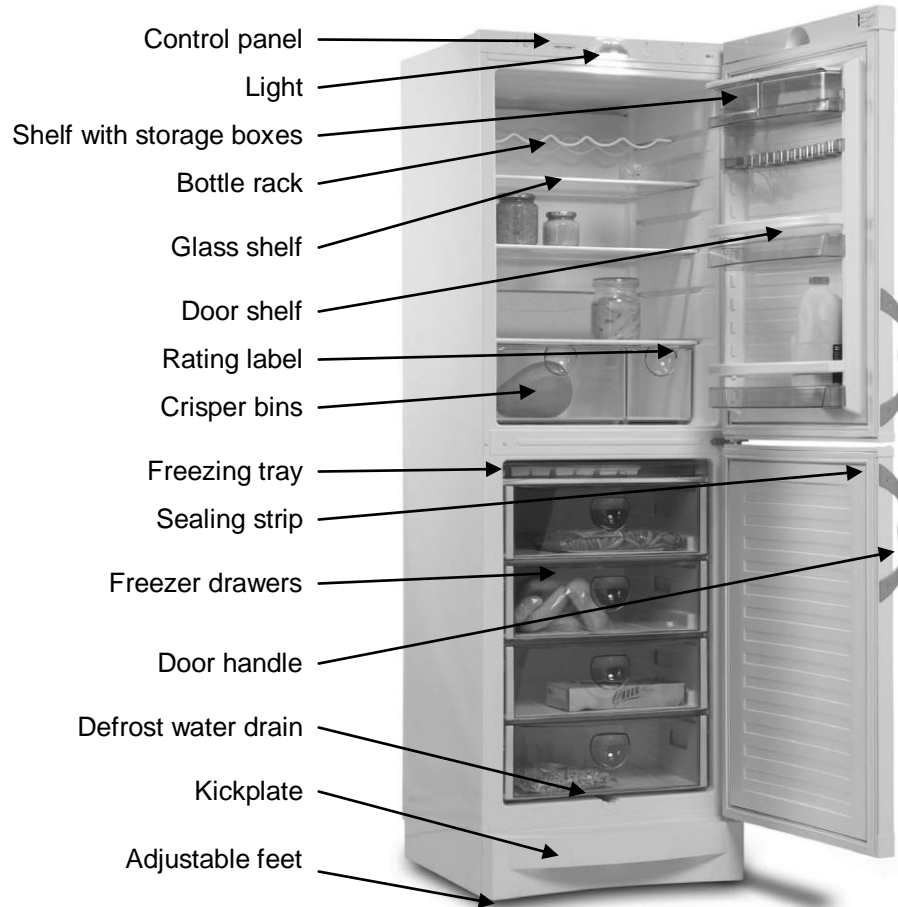
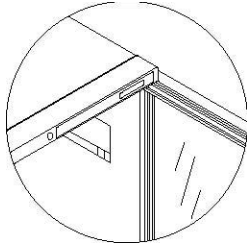

fig. 1

Electrical Connection

The technical information for the appliance can be seen on the rating plate on the right inner wall of the refrigerator compartment.



Important: Wiring and connections in power supply systems must be in accordance with all applicable (local and national) electrical codes. Consult these code lengths and sizes prior to cabinet installation.

Power supply: (Grounded through 3 wire power supply cord) 115V ac, 60 Hz single phase

Maximum fuse size: 10 amps

This appliance is equipped with a three-prong (ANSI type 5-15P grounded) plug for your protection against shock hazards. The appliance should be plugged into a properly grounded three-prong receptacle

Do not under any circumstances cut or remove the round grounding prong from the appliance plug.

Do not under any circumstances use extension cords.

Installation and Start-up

Placement

For safety and operational reasons, the appliance must not be installed outdoors. The appliance should be placed on a level surface in a dry, well ventilated room (max. 75% relative air humidity). Never place the appliance close to sources of heat such as ovens or radiators, and avoid placing it in direct sunlight.

Installation

The surface on which the appliance is to be placed must be level.

The appliance can be installed as a free-standing unit against a wall or built into a kitchen element (fig. 2). If two appliances are placed side by side, there must be at least 30 mm (just over 1") clearance between them (fig. 3).

After installation, the plug should be accessible.

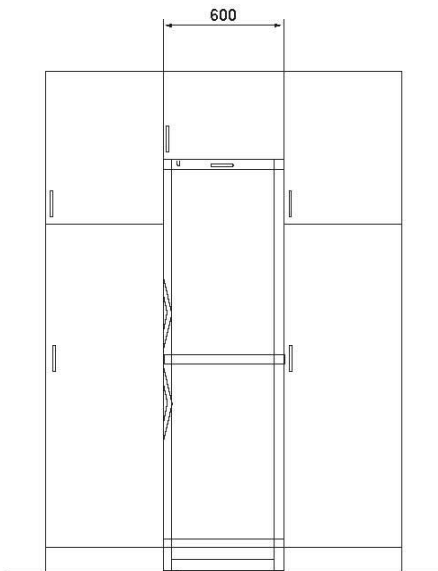

fig. 2

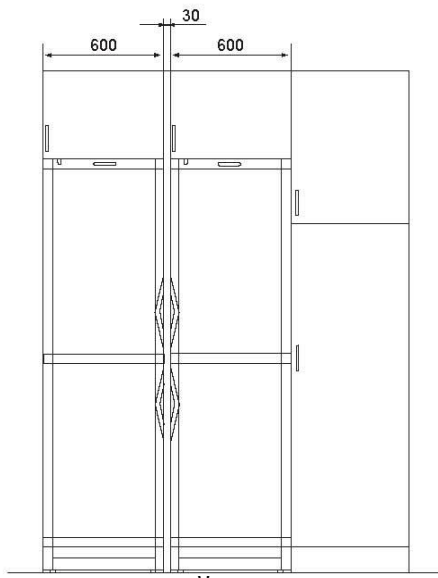

fig. 3

The appliance viewed from above

If the appliance is placed beside a wall, there must be sufficient room for the freezer door to be opened wide enough to allow the drawers to be pulled out (fig. 4).

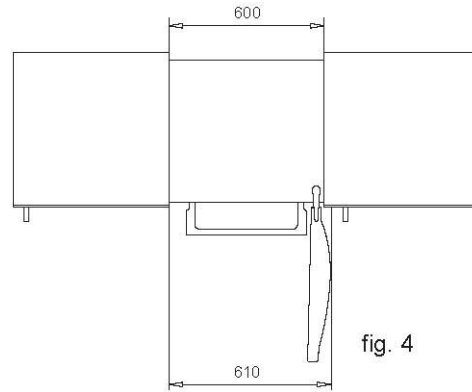

fig. 4

Spacers

The spacers on the rear of the appliance ensure sufficient air circulation. Fit the two spacers supplied with the appliance as shown in fig. 5.

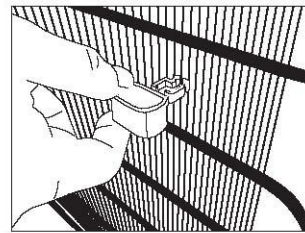

fig. 5

Ventilation

It is important that the appliance be well ventilated and that air can circulate unhindered above, below and around it. The figures to the right illustrate how the necessary air circulation can be ensured (figs. 6 and 7).

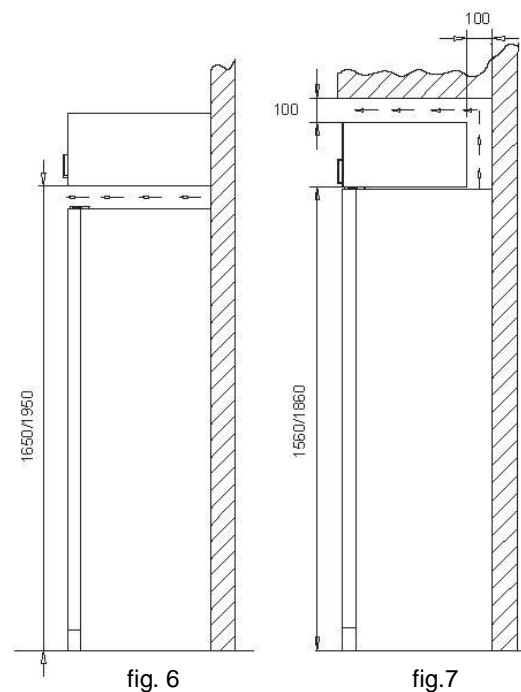

fig. 6

fig. 7

Setting up

It is important that the appliance be absolutely level. To level the appliance, remove the kick plate below the door and screw the adjustable feet up or down (figs. 8 and 9). If necessary, it is possible to adjust the back feet before the upright is installed. Use a spirit level to check that the appliance is absolutely level.

If the appliance is to be placed on a soft surface, e.g. floorboards or a carpet, it is best to recheck whether the appliance is still level after a period of time as the underlying surface may give under the weight of the appliance.

Do not tilt the upright more than 7 degrees to avoid damaging the floor (figs. 10 and 11).

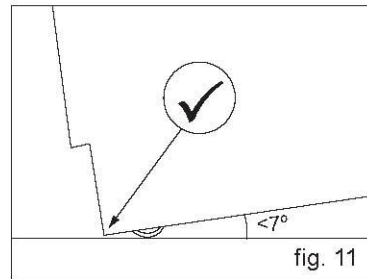
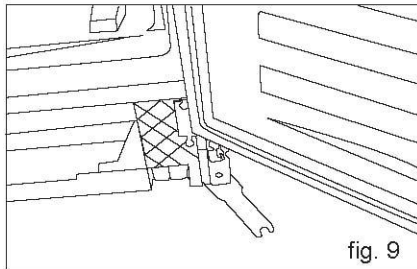
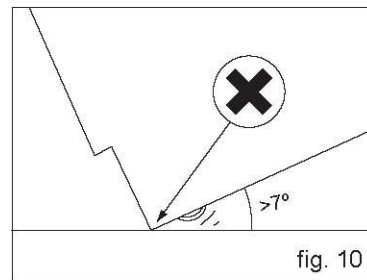
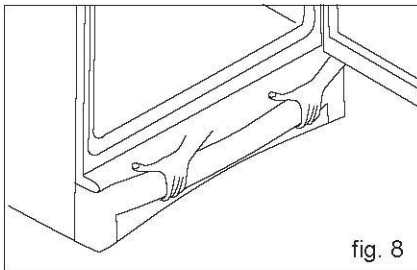

Reversing the Doors

The doors can be changed from right-hinged to left-hinged and vice versa as follows:

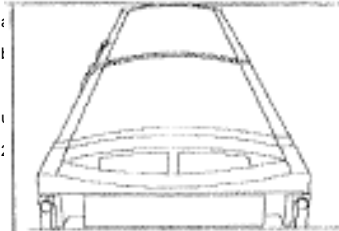

1 Lay the appliance on its back with the doors uppermost

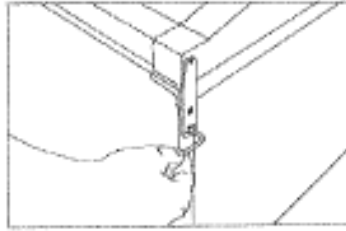

2 Remove the upper hinge.
3 Move the plastic plugs to where the upper hinge was fitted.
4 Lift off the upper door and lay it aside

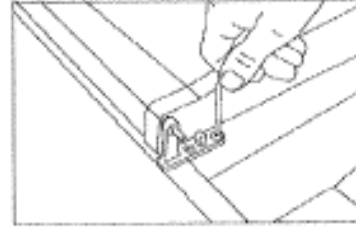

5 Remove the middle hinge by unscrewing the screws.
6 Lift off the lower door and lay it aside

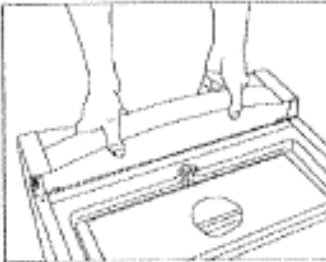

7 Remove the kick plate by pulling it outwards and upwards

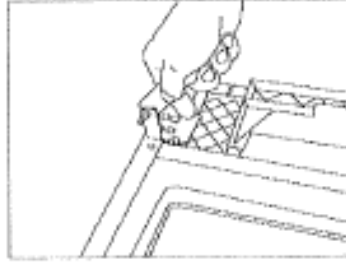

8 Loosen lock nut with the fork wrench enclosed and move the pin.

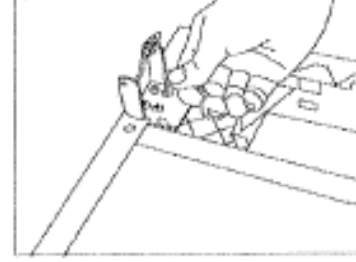

9 Remove the lower hinge. Rotate the hinge through 180° and refit it on the opposite side of the appliance.
10 Refit the kick plate

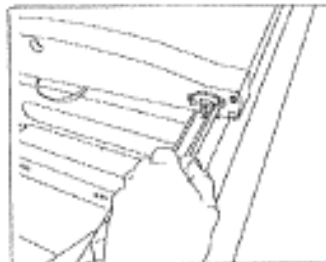

11 Remove the door-closer and refit it on the opposite side

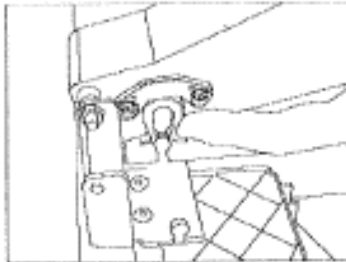

12 Remember to pull the pin in the door closer towards the side before fitting the door

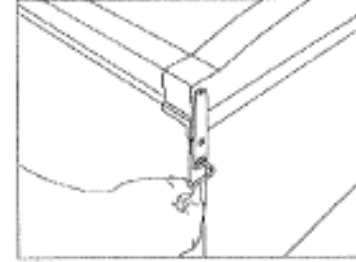

13 Fit the upper door
14 Fit the upper hinge



15 Remove the door handles and refit them on the opposite side. Refit the caps.
16 The appliance must be allowed to stabilise in an upright position for at least 1 hour before being switched on.

17 After reversing the door(s), it is important to check that the sealing strip provides a tight seal all the way round. If it does not, carefully heat the strip all the way round using a hair dryer. Then ease the strip outwards slightly so that it forms a tight seal against the cabinet. Be careful not to heat the strip so much that it melts!

Operation and Function

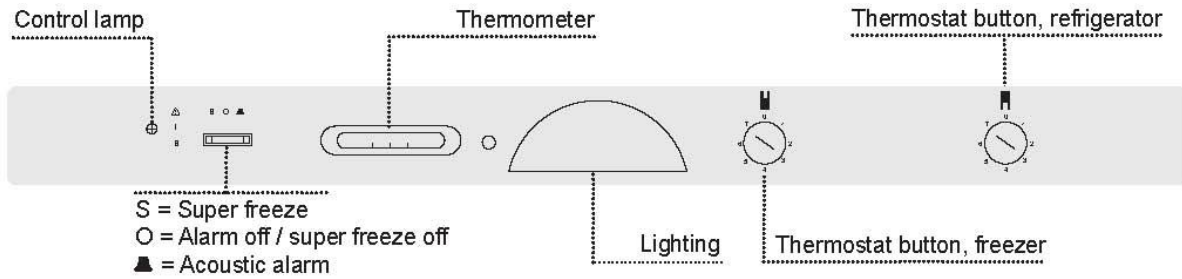

fig. 12

Refrigerator section

The thermostat button can be set from **1** (min.) to **7** (max.). A suitable setting must be found by trial and error. Start by setting the button to **4**. Check the temperature, then adjust the setting upwards or downwards as required. Usually, a temperature of 41°F (5°C) is recommended for items stored in a refrigerator. To check the temperature, place a thermometer in a glass of water positioned in the center of the cabinet for 12 hours. An average temperature of 41°F should be found in the center of the cabinet.

Freezer section

Always maintain a correct storage temperature.

The thermostat button can be set from **1** (min.) to **7** (max.). A temperature of 0°F (-18°C) is recommended for items stored in a freezer. (Maintaining a temperature lower than this consumes additional energy.) The temperature in the freezer is displayed on the thermometer.

- The control lamp lights green when the power supply is connected correctly.
- The control lamp lights yellow when Super Freeze is activated.
- The indicator lamp lights red and the acoustic alarm sounds if the temperature in the freezer is too high. To switch off the acoustic alarm, set the freeze button to **O** (see fig. 12). The indicator lamp continues to light red as long as the temperature in the freezer remains too high.

When starting the freezer for the first time, switch off the acoustic alarm by setting the freeze button to **O**. Once the recommended temperature (0°F, or -18°C) has been achieved in the freezer, set the freeze button to the **▲** symbol. This will allow the acoustic alarm to sound if the temperature in the freezer becomes too high.

It is normal that the indicator lamp lights red when the freezer is started for the first time. It will also occasionally light red when large quantities of fresh material are put in the freezer simultaneously.

Glass shelves

The shelves are made of tempered glass and can be repositioned within the cabinet. To move the shelves, the door must be opened 90°. To remove a shelf, pull it forwards and lower it. The shelf can then be removed and placed in the desired position. From the top and downwards, the shelves are suitable for storing bakery products, ready-made meals, dairy products, meat products and sliced meat.

Storage boxes

The storage boxes can either be placed in the door or on the glass shelves. Their tight-fitting lids prevent the products stored in them from drying out and saves the need for further packaging. The boxes are ideal for storing items such as butter and cheese.

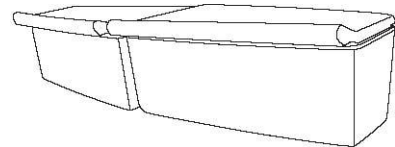

fig.13

Bottle rack

The bottle rack is ideal for both large and small bottles.

Crisper bins

The crisper bins are ideal for storing fruit and vegetables. The shelf above the bins functions as a lid, maintaining humidity and preventing the items stored in the bins from drying out.

Glass shelf with slide damper

The slide damper above the crisper bins allows the temperature and humidity in the bins to be regulated.

- Opening the damper reduces the temperature and humidity.
- Closing the damper increases the temperature and humidity.

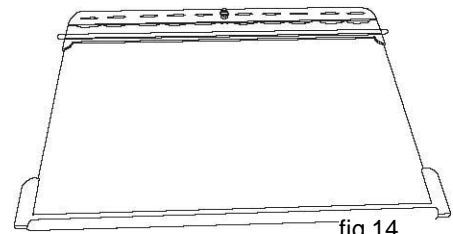

fig.14

Shelves in the door

The shelves in the door are practically positioned with the box shelf at the top, the egg holder in the middle and door shelves at the bottom. They provide ample space for storing large and small bottles, cartons, jars and tubs. All shelves can be repositioned.

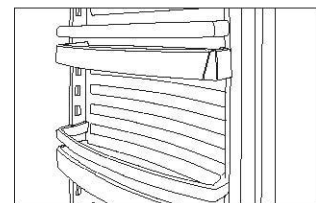
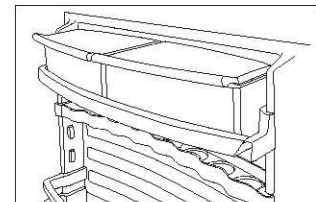

fig.15

Freezer section

The freezer section is a four-star freezer, approved for freezing and storing foodstuffs. With the exception of no-frost models, the freezer is equipped with a practical tray for freezing loose berries, ice cubes, etc.

Freezing

To keep food at its best, items must be frozen to 0°F (-18°C) as quickly as possible.

When the Super Freeze (**S**) button is pressed, the compressor runs continuously, thus reducing the temperature as far as possible. If items weighing 6½ lbs or more are to be frozen, the Super Freeze button should be activated about 24 hours in advance.

There is no need to use Super Freeze when pre-frozen items are placed in the freezer or when small, single items are involved.

The control lamp lights yellow as long as the Super Freeze function is active. Remember to switch the Super Freeze function off again approx. 24 hours after placing items in the freezer. Otherwise, the appliance will use more electricity than necessary.

Only freeze fresh high-quality products. Meat, poultry, fish, vegetables, fruit, dairy products and ready-made meals are suitable for freezing. Items with a high water content, e.g. lettuce, radishes, grapes, apples, pears and cucumbers, are not suitable for freezing.

Pack items to be frozen in airtight containers, freezer bags or the like. Freeze items in suitable portions. Do not freeze vegetables in portions larger than 5½ lbs. Do not freeze meat in portions larger than 5½ lbs. Keep packages dry to prevent them from freezing together. To ensure rapid freezing, make sure, as far as possible, that items placed in the freezer are not touching. Ensure that there is as little air in the packages as possible to prevent the surfaces of the items from drying out.

Always remember to write the date, content and quantity on the packages before placing them in the appliance. It is a good idea to group items within the freezer. Keep vegetables in one drawer, meat in another, and so on.

Thawing

Frozen vegetables and fruit require no thawing before use and can be immersed in boiling water direct from the freezer.

To thaw meat, it is advisable to take it out of the freezer the day before it is to be used and place it in the refrigerator section to defrost. This ensures the best hygiene and maintains meat quality as much as possible.

Refreezing

If purchased items of frozen food thaw before reaching home, they must not be refrozen but should be consumed within 24 hours or cooked immediately and then frozen.

Frozen items that have been placed in the refrigerator for thawing may be refrozen without risk if they have only just thawed.

Note: Glass bottles or cans containing carbonated (fizzy) drinks must never be placed in the freezer as they may explode.

Defrosting

Automatic defrosting of refrigerator section

The refrigerator is defrosted automatically. Defrost water runs through a pipe and is collected in a tray above the compressor where the heat generated by the compressor causes it to evaporate. The defrost water tray should be cleaned at intervals.

Defrosting the freezer

The items stored and the humidity of the air gradually cause frost and ice to form in the freezer. A thin layer of frost or ice does not affect freezer performance, but the thicker the layer, the higher the energy consumption. Loose frost can be removed using a plastic or wooden scraper.

Never use a knife or other sharp implement that might damage the inside of the freezer.

When the layer of frost and ice exceeds 1/4 inch, the freezer should be completely defrosted.

Proceed as follows:

1. Press the Super Freeze button 4-5 hours before defrosting. This lowers the temperature of the items stored to approx. -13°F (-25°C), thus prolonging the length of time they remain frozen after having been removed from the freezer (see step 4 below).
2. Switch the freezer off by turning the freezer thermostat button to **0**.
3. Pull out the drain spout at the bottom of the cabinet and place a bowl under it to collect defrost water (fig. 16). If the spout is frozen in place, lay a cloth which has been soaked in hot water over it for a few minutes.
4. Remove the items of food. Place them in the refrigerator or wrap them in newspaper to keep them as cold as possible.
5. Place a bowl of hot (but not boiling) water in the freezer.
6. To prevent the floor from becoming wet during defrosting, check progress from time to time and lay towels around the bowl on the floor to protect against ice and splashes. When all the frost and ice have melted, clean the inside of the cabinet with a mild detergent solution. Dry the freezer with a soft cloth.
7. Restart the freezer by turning the freezer thermostat button to the required setting. If many items are to be returned to the freezer, activate the Super Freeze button. Remember to switch Super Freeze off again.
8. Return items to the freezer approx. 5 minutes after having switched it on.

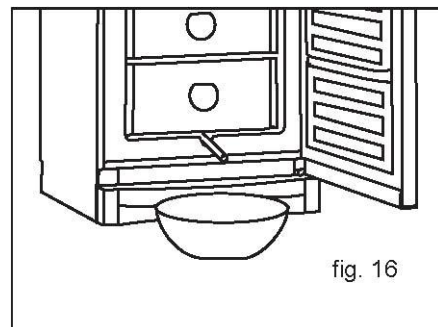

Cleaning and Maintenance

Cleaning

Disconnect the power supply before cleaning the inside of the cabinet.

The cabinet is best cleaned using warm water (max. 150°F) with a little mild detergent. Never use cleaning agents that scour. Use a soft cloth. Rinse with clean water and dry thoroughly. It is important to prevent water from entering the control panel.

The defrost water channel, in which condensation from the evaporator runs, is located on the rear wall of the cabinet and must be kept clean. Add a few drops of disinfectant to the defrost water drain a couple of times a year, and clean the drain using a pipe cleaner or the like. Never use sharp or pointed implements.

The sealing strip around the doors must be cleaned regularly to prevent discoloration and prolong service life. Use clean water. After cleaning the sealing strip, check that it continues to provide a tight seal.

Dust collecting on the compressor and in the compressor compartment is best removed using a vacuum cleaner. It is possible to clean beneath the appliance by removing the kick plate.

Stainless steel or aluminum doors are best cleaned using a soft cloth with a spray made for cleaning metallic surfaces. Various suitable products are available from most household appliance distributors.

If the appliance is not to be used for any length of time, switch it off, empty it, clean the cabinet and fittings, and leave the doors slightly open to allow air circulation and prevent smells.

Replacing the light bulb

Unscrew the bulb without removing the shade. Bulbs with an output of more than 12 W must not be used.

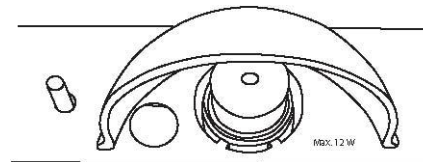

fig. 17

Save energy

- Cool hot food and beverages before placing them in the appliance.
- Thaw frozen items in the refrigerator section.
- Keep the doors closed as much as possible.
- Ensure that the doors are not prevented from closing tightly.

Disposal

Environmental regulations on disposal must also be observed. When disposing of the appliance you should contact your local authority technical department who will inform you of how collection and recycling of such units take place in your area. By ensuring that this product is disposed of correctly, you will help prevent potential negative consequences for the environment and human health, which could otherwise be caused by inappropriate waste handling of this product. Disposal must be carried out in accordance with local environmental regulations for waste disposal.

For more detailed information about treatment, recovery and recycling of this product, please contact your local city office, your household waste disposal service or the shop where you purchased the product.

Troubleshooting

Problem	Possible cause	Remedy
The control lamp is not lit.	Power failure; the fuse is blown; the appliance is not plugged in correctly.	Check that power is connected. Reset the fuse.
Water collects on the glass shelves.	Items of food at the back of the shelves are in contact with the rear wall of the cabinet, thus causing condensation to run onto the shelf.	Move the rearmost items forward.
Water collects in the bottom of the refrigerator/freezer.	The defrost water pipe is blocked.	Clean the defrost water channel and the drain hole on the rear wall of the cabinet.
Vibration or bothersome noise.	The appliance is not level.	Level the appliance using a spirit level.
	The appliance is resting against other kitchen elements.	Move the appliance away from the kitchen cabinets or appliances it is in contact with.
	Bins, containers or shelves are not positioned correctly or are jammed.	Check movable fittings and adjust them if necessary.
	Containers or bottles inside the cabinet are rattling against one another.	Move containers and/or bottles apart.
Compressor runs continuously.	Temperature setting too low.	Raise the temperature setting.
	High room temperature.	Ensure adequate ventilation.
Temperature in freezer too high.	Temperature setting too high.	Lower the temperature setting.
	The quantity of fresh items placed in the freezer at a time is greater than the capacity of the appliance.	Wait a few hours and then recheck the temperature.
Temperature in refrigerator too high.	Temperature setting too high.	Lower the temperature setting.
	Many items have been placed in the refrigerator section at the same time.	Distribute items within the cabinet to improve air circulation.
	The door is opened too often.	Keep door closed.

Warranty

Call customer service toll free in the U.S.A. @ 1-800-932-4267; Monday to Friday 9:00 am. - 5:00 p.m. (ET).

ONE-YEAR LIMITED WARRANTY

Within the 48 contiguous United States, for one year from the date of purchase, when this appliance is operated and maintained according to instructions attached to or furnished with the product, warrantor will pay for factory-specified parts and repair labor to correct defects in materials or workmanship. Service must be provided by a designated service company. Outside the 48 states, all parts are warranted for one year from manufacturing defects. Plastic parts, shelves and cabinets are warranted to be manufactured to commercially acceptable standards, and are not covered from damage during handling or breakage.

5-YEAR COMPRESSOR WARRANTY

The compressor is covered for 5 years.

Replacement does not include labor.

ITEMS WARRANTOR WILL NOT PAY FOR:

- Service calls to correct the installation of your appliance, to instruct you how to use your appliance, to replace or repair fuses or to correct wiring or plumbing.
- Service calls to repair or replace appliance light bulbs or broken glass shelves. Consumable parts (such as filters) are excluded from warranty coverage.
- Damage resulting from accident, alteration, misuse, abuse, fire, flood, acts of God, improper installation, installation not in accordance with electrical or plumbing codes, or use of products not approved by warrantor.
- Replacement parts or repair labor costs for units operated outside the United States.
- Repairs to parts or systems resulting from unauthorized modifications made to the appliance.
- Expenses for travel and transportation for product service in remote locations.
- The removal and reinstallation of your appliance if it is installed in an inaccessible location or is not installed in accordance with published installation instructions.

DISCLAIMER OF IMPLIED WARRANTIES; LIMITATION OF REMEDIES

CUSTOMER'S SOLE AND EXCLUSIVE REMEDY UNDER THIS LIMITED WARRANTY SHALL BE PRODUCT REPAIR AS PROVIDED HEREIN. IMPLIED WARRANTIES, INCLUDING WARRANTIES OF MERCHANTABILITY OR FITNESS FOR A PARTICULAR PURPOSE, ARE LIMITED TO ONE YEAR. WARRANTOR SHALL NOT BE LIABLE FOR INCIDENTAL OR CONSEQUENTIAL DAMAGES. SOME STATES DO NOT ALLOW THE EXCLUSION OR LIMITATION OF INCIDENTAL OR CONSEQUENTIAL DAMAGES, OR LIMITATIONS ON THE DURATION OF IMPLIED WARRANTIES OF MERCHANTABILITY OR FITNESS, SO THESE EXCLUSIONS OR LIMITATIONS MAY NOT APPLY TO YOU. THIS WARRANTY GIVES YOU SPECIFIC LEGAL RIGHTS AND YOU MAY ALSO HAVE OTHER RIGHTS, WHICH VARY FROM STATE TO STATE.

Felix Storch, Inc.
Summit Appliance Division
770 Garrison Avenue
Bronx, NY 10474
Phone: (718) 893-3900
Fax: (718) 842-3093
www.summitappliance.com

The logo for Summit Appliance, featuring the word "SUMMIT" in a bold, black, sans-serif font. The letters are slightly shadowed, giving it a three-dimensional appearance.

For parts and accessory ordering, troubleshooting
and helpful hints, visit:

www.summitappliance.com/support