

JCH/A1 Series "H" in part number indicates halogen lighting. These models not available with heat lamps. Shown with optional duct cover (sold separately).

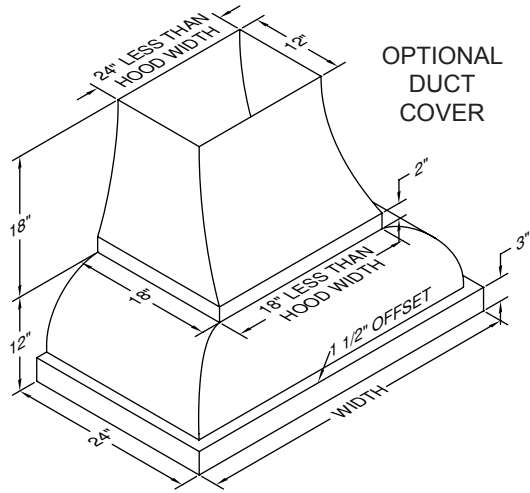

Recommended Mounting Height

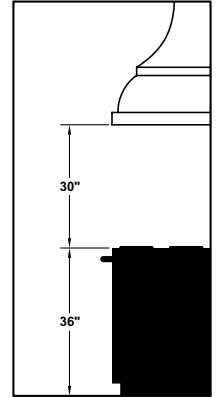

*Exceeding recommended mounting height may compromise performance.

Connection Diagrams (36" - 48" Widths)

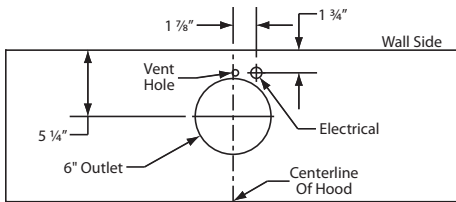

B100 Single Blower (Top View)

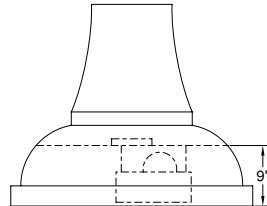

(Front View)

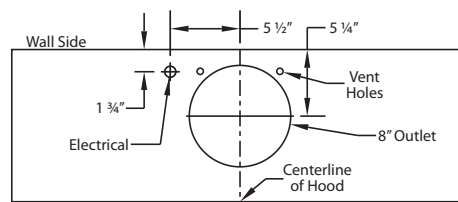

B200 Dual Blower (Top View)

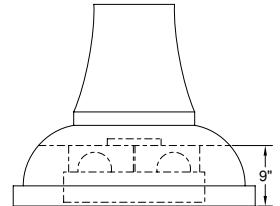

(Front View)

Connection Diagram (48" - 60" Widths)

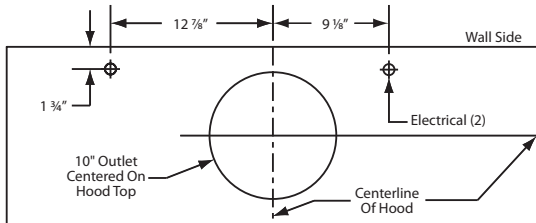

900 CFM B200 Dual & B100 Single Blower (Top View)

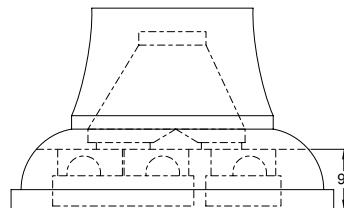

VP562 Standard Transition Installed (Front View)

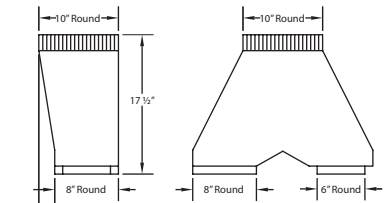

VP562 Standard Transition Included

Connection Diagram (54" - 66" Widths)

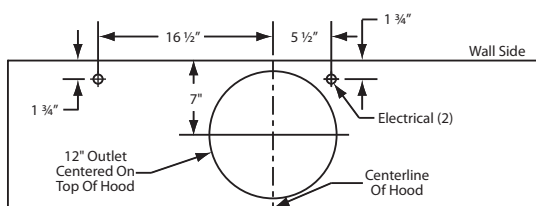

1200 CFM Double B200 Dual Blowers (Top View)

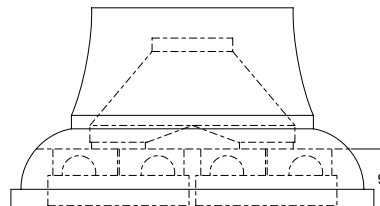

VP563 Standard Transition Installed (Front View)

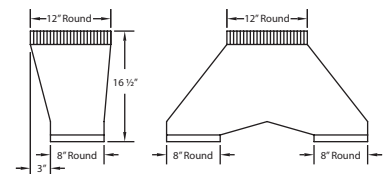

VP563 Standard Transition Included

Electrical/Mechanical Specifications For Blower Units

Model	Volts	Amps*	Hz	RPM	CFM SP@0.0"	Equivalent CFM*	CFM SP@0.1"	CFM SP@0.2"	CFM SP@0.3"	Minimum Round Duct Size	Sones#
B100 Single	115	1.5	60	1550	300	450	273	245	225	6" (28 in. ²)	5.4
B200 Dual	115	2.9	60	1550	600	900	531	480	430	8" (50 in. ²)	6.5
B200 Dual & B100 Single	115	4.4	60	1550	900	1350	804	725	655	VP562: 10" (79 in. ²)	6.3
Two B200 Duals	115	5.8	60	1550	1200	1800	1062	960	860	VP563: 12" (113 in. ²)	6.6

* Add 0.5 amp for each halogen light. Hoods are available with halogen lights (2 lights: 30" - 41", 3 lights: 42" - 53", 4 lights: 54" - 66").

Because the Magic Lung® blower uses centrifugal filtration rather than conventional baffle or mesh filters, the Magic Lung® blower can handle cooking equipment with higher cubic feet per minute (CFM) requirements and can deliver equivalent CFM much more efficiently than other than other filtration systems. When comparing the Magic Lung® with other blower units made by other manufacturers, use the "Equivalent CFM".

Ratings in accordance with the Standard Test Code by the Energy Systems Laboratory of the Texas Engineering Experiment Station.