

ZIDI240BII

GE Monogram® Double-Drawer Refrigerator Module (Custom panel required)

ZIDS240BSS

GE Monogram Double-Drawer Refrigerator Module (Stainless steel)

Dimensions and Installation Information (in inches)

Installation Space

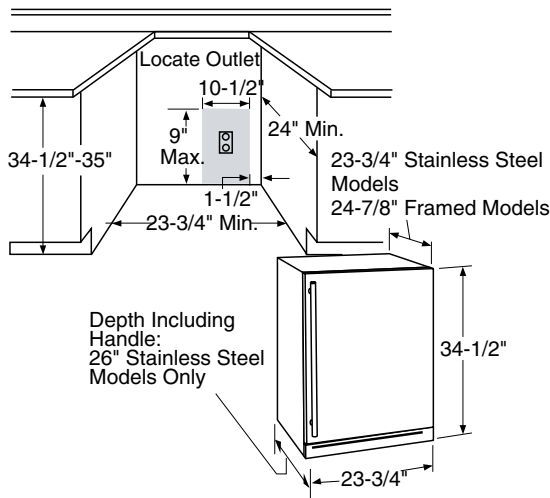

The cutout depth must be 24"

- Both models can be installed flush with standard cabinetry.
- Designed to be built-in only. Cannot be used free-standing.
- White case and drawer sides, black vented toe-kick with optional stainless steel toe-kick supplied.

Additional Specifications:

- A 120 volt 60Hz., 15 or 20 amp power supply is required. An individual property grounded branch circuit or circuit breaker is recommended. Install a properly grounded 3-prong electrical receptacle recessed into the back wall as shown. Electrical must be located on rear wall as shown.
- Note:** GFI (ground fault interrupter) is not recommended.

For a complete food storage center, install two Monogram refrigeration modules side-by-side.

Note: Reversible door swing on wine chillers/reserves and beverage centers only. See below for combination cutout dimensions.

Important Note: Products must operate from separate, properly grounded receptacles.

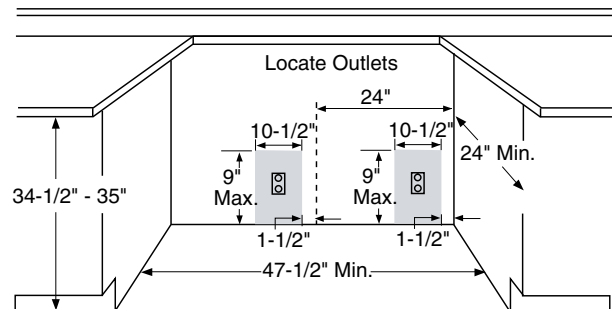

Note: Additional cutout width may be required for models with custom panels.

For answers to your Monogram®, GE Profile™ or GE® appliance questions, visit our website at ge.com or call GE Answer Center® service, 800.626.2000.



imagination at work



Listed by
Underwriters
Laboratories

ZIDI240BII

GE Monogram® Double-Drawer Refrigerator Module (Custom panel required)

ZIDS240BSS

GE Monogram Double-Drawer Refrigerator Module (Stainless steel)

Dimensions and Installation Information (in inches)

Grounding the Double-Drawer Refrigerator

IMPORTANT - (Please read carefully)

FOR PERSONAL SAFETY, THIS APPLIANCE MUST BE PROPERLY GROUNDED.

The power cord of this appliance is equipped with a 3-prong (grounding) plug which mates with a standard 3-prong (grounding) wall receptacle to minimize the possibility of electric shock hazard from this appliance.

Have the wall outlet and circuit checked by a qualified electrician to make sure the outlet is properly grounded.

When a standard 2-prong wall outlet is encountered, it is your personal responsibility and obligation to have it replaced with a properly grounded 3-prong wall outlet.

DO NOT, UNDER ANY CIRCUMSTANCES, CUT OR REMOVE THE THIRD (GROUND) PRONG FROM THE POWER CORD.

DO NOT USE AN ADAPTER PLUG TO CONNECT THE REFRIGERATOR TO A 2-PRONG OUTLET.

DO NOT USE AN EXTENSION CORD WITH THIS APPLIANCE.

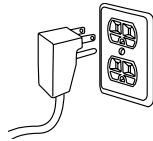

3/4" Overlay Panel Dimensions

Model ZIDI240WII requires customer-provided overlay drawer panel.

- The overlay panel must be secured to a 1/4" thick backer panel which slides into the trim. A .10" thick spacer panel must be placed between the custom and backer panel.

- A custom handle of your choice, supplied by your cabinet maker, must be installed on the overlay panel.

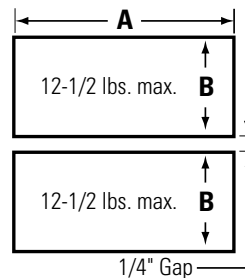
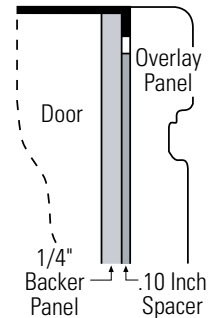

3/4" Overlay Panel Dimensions (in inches)

	A (Width)	B (Height)
1/4" Backer	23-3/16"	14-11/16"
0.10" Spacer	22-1/2"	14-3/16"
3/4" Overlay	23-5/8"	15-1/16"

NOTE: Max. assembled drawer panel weight is 25 lbs.

IMPORTANT: Maintain a 1/4" gap between the panels when installed.

Assemble overlay panels with glue and screws.

- Center spacer panel on the backer panel, left to right and top to bottom. Secure the panels with glue.
- Center the spacer/backer panel on the overlay panel. Secure with glue and screws. Countersink screws into the backer panel.

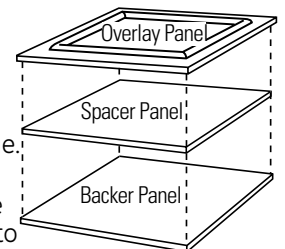

For answers to your Monogram®, GE Profile™ or GE® appliance questions, visit our website at ge.com or call GE Answer Center® service, 800.626.2000.



imagination at work

Specification Revised 7/05
120032



Listed by
Underwriters
Laboratories

Specification Created 1/11

120033

ZIDI240BII

GE Monogram® Double-Drawer Refrigerator Module (Custom panel required)

ZIDS240BSS

GE Monogram Double-Drawer Refrigerator Module (Stainless steel)

Features and Benefits

- Full-Extension Slide-Out Refrigerated Drawers - Storage for everything from whole melons to 146 12 oz. cans
- Electronic Adjustable Temperature Control - Offers a range of temperatures for precise chilling
- LED Temperature Display - Allows you to monitor the temperature at a glance
- Full-Width LED Lighting - Puts contents into clear view
- Custom Panel and Handle Required - Customer must install a custom door panel and handle to complement their décor (ZIDI240BII only)
- Adjustable Dividers - Maximizes usable storage space and flexibility
- Removable Drawer Bin - Convenient for separating loose items
- Fold-Down Shelf - Maximizes usable storage space
- Model ZIDS240BSS - Stainless steel
- Model ZIDI240BII - Custom panels and handles required

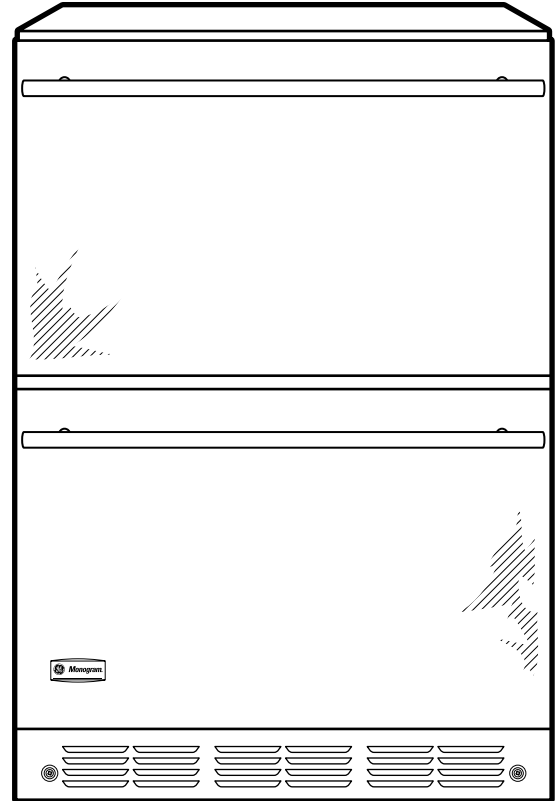

For answers to your Monogram,® GE Profile™ or GE® appliance questions, visit our website at ge.com or call GE Answer Center® service, 800.626.2000.



imagination at work



Listed by
Underwriters
Laboratories