

Packaged Terminal AIR CONDITIONERS



COOL ONLY | HEAT PUMPS | ELECTRIC HEAT

Friedrich

DIGITAL CONTROLS

Large, easy-to-read LED display for precise temperature control and energy savings



Friedrich Digital PTAC.
Loaded with over 40 standard features, it's like a **FREE UPGRADE** over standard PTACs.

REMOTE CONTROL

Optional accessory for added convenience. Ideal for ADA compliant rooms



Designed and built for dependable operation

Electronic temperature limiting

Owners and operators will appreciate the flexibility to set separate heat and cool range limits.

Constant comfort room monitoring

The Smart Center will automatically run the fan to briefly sample the room temperature every nine minutes to ensure desired conditions are maintained.

Desk control ready

Allows hotel owners to control units from a central location.

Auxiliary fan ready

Allows multiple rooms to share one unit.

Remote thermostat operation

Control Friedrich units using either a wall-mounted thermostat, remote control or built-in controls.

"Instant Heat" heat pump mode

Instant heat quickly heats a room to the desired temperature for increased comfort.

Remote control operation

New remote control lets user operate with more convenience (remote control is an optional accessory).

Even heat monitoring

Checks room temperature and automatically adds heat boost if necessary.

Random compressor restart

Protects electrical systems from overload when power is restored.

High efficiency

Reduces your operating costs.

Room freeze protection

Heat initiated if temperature falls to 40°F in an unoccupied room, raising temperature to 46°F.

Filtered fresh air intake

Ideal for applications where indoor air quality is important.

Fan cycle control

Select fan cycling or continuous fan operation for more comfort options.

Electronic defrost control

Ensures more run time in the efficient heat pump mode.

Ships individually palletized

Whether you order 1 or 100 units, each unit is individually palletized to reduce the risk of shipping damage.

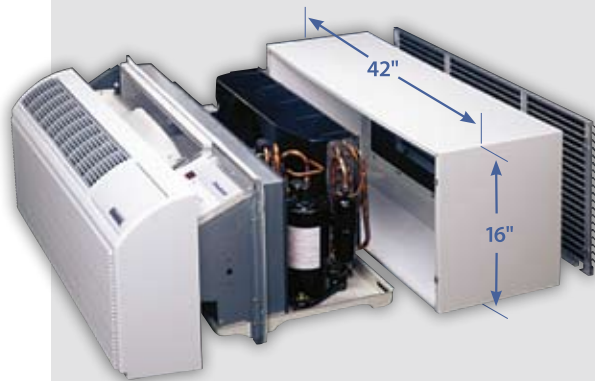

Fits other PTAC sleeves without a baffle kit.

IMPORTANT NOTE: Sleeves are sold and shipped separately to accommodate new construction and replacement requirements.

	<p>5 YEAR WARRANTY On the sealed refrigeration system. Limitations apply. Refer to warranty documentation for details.</p>
--	---

Chosen 'QUIETEST' by guests in sound testing conducted in actual guest rooms

"Quietest"



Guests rated Friedrich PTAC the quietest. Here's why—

Quiet start/stop fan delay

We developed a soft start/stop feature that reduces transitional noise that is usually associated with compressor start-up.

Quiet, efficient rotary compressor

Mounted with vibration isolators to keep the compressor running smoothly and quietly.

Ultraquiet air system

Our new air system moves the air very quietly and efficiently. Low/sleep setting is noticeably quieter than other popular brands.

SURVEY DETAILS

In a blind survey, travelers rated Friedrich PTAC the QUIETEST among five top competitive models and a full 15% better than the next best unit on SOUND QUALITY. Friedrich also received twice as many votes for BEST APPEARANCE than the next best scoring unit.

super quiet
do not disturb
technology



Designed for a longer product life

Durable design

Tamper-resistant grille, enclosed clamshell motor and dual thumbscrews are just some of the features that Friedrich engineers added for a longer product life.

Powder coat paint process

Durable, powder coat paint finish.

Aluminum endplates

Corrosion-resistant construction for longer life.

Indoor coil frost sensor

Protects the compressor to lengthen the life of the unit.

Easy serviceability

Single motor design

Fewer parts to maintain.

Service error code storage

Error code memory facilitates improved unit diagnostics.

Top-mounted antimicrobial air filters

Quick and easy access. Easy to clean. Protection from fungal and bacterial growth.

Emergency heat override

Ensures heat mode operation even in the unlikely event of compressor failure.



STANDARD ON ALL MODELS.

This advanced corrosion protection treatment protects the outdoor coil against deterioration and extends the life of the unit especially in harsh coastal environments.

ANTIMICROBIAL AIR FILTERS

Top-mounted for quick access. Easy to clean. Antimicrobial protection against fungal and bacterial growth.

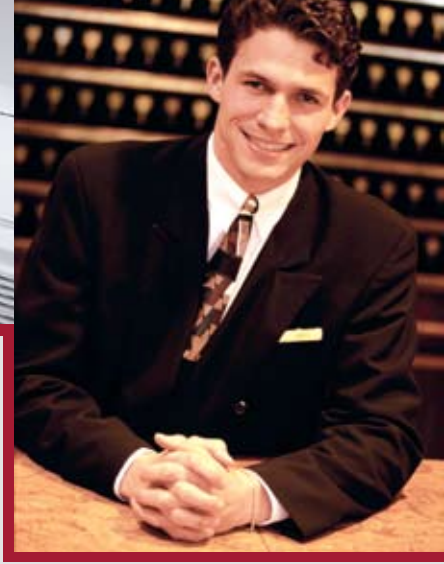

“The Friedrich unit won hands down”

Just one of the comments from Friedrich PTAC owners.

“Several years ago, we started experiencing an unusual amount of guest complaints about the noise and efficiency of our PTAC units, which were between 10 and 20 years old.

We made a decision to start replacing our PTAC units at the rate of 25% per year. We purchased six different Brand Name units for an internal evaluation, both from a management opinion as well as guest opinions.

Without a doubt, THE FRIEDRICH UNIT WON HANDS DOWN ON ALL COUNTS.

From a management point of view, the unit is EASY TO INSTALL, EASY TO MAINTAIN and clean and operates QUIETLY and EFFICIENTLY. From a guest point of view, the unit is QUIET, COMFORTABLE and EASY TO USE. From a financial point of view, the Friedrich PTAC unit is highly competitive.

As we enter the 3rd phase of PTAC replacement, I am happy to report that our maintenance cost on the Friedrich units has been minimal, freeing up our maintenance staff for other projects.

I highly recommend the Friedrich PTAC unit.”

ROBERT KLEIN CHA, GENERAL MANAGER
HOLIDAY INN NATIONAL AIRPORT
ARLINGTON, VIRGINIA

“This is the first time we are building our OWN project. In the past we have always built for someone else... I spend more time doing research on AC than most people do because it's that important to me. I'm all about customer satisfaction. I want 99% of the people back... I researched 4 brands – Carrier, GE, Friedrich and Amana. A major factor was quietness. **THE REVIEWS FOR (FRIEDRICH) QUIETNESS WERE KEY TO ME.** Also, the unit has some control of the fan that isn't there on Amana.”

DOUG WRIGHT,
LA QUINTA
RIFFLE, COLORADO

“I haven't had any complaints about noise or vibration... We are a suburban hotel with mostly business travelers who are very demanding... **I think it's a GOOD QUALITY unit for the price.** Maintenance is pretty easy. I have never had to go back to them (PTAC units) since they were put in.”

DAN BOWMAN,
HILTON GARDEN INN
LOVELAND, OHIO

Packaged Terminal Air Conditioner Model Identification Guide

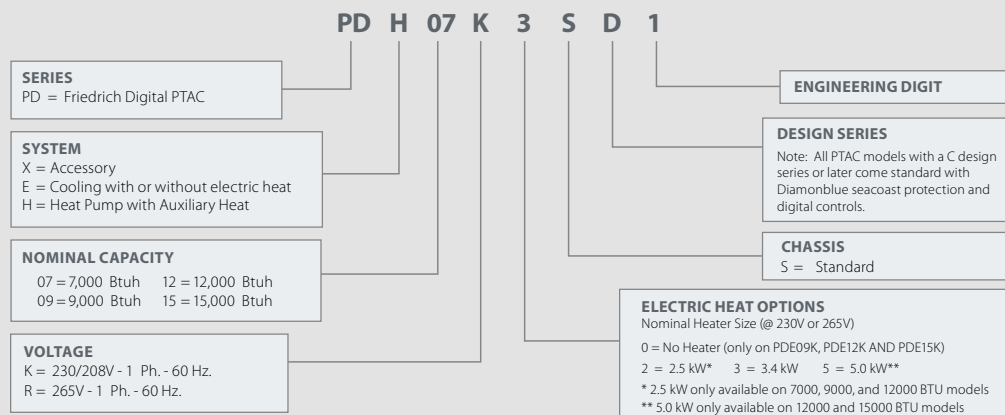

PTAC optional accessories

WALL SLEEVE PDXWS

Galvanized steel is prepared in a state-of-the-art, multistep process for stronger paint adhesion, then powder coated with a polyester finish and cured in an oven for exceptional durability. The wall sleeve is insulated for thermal efficiency. 16" x 42" x 13 3/4"

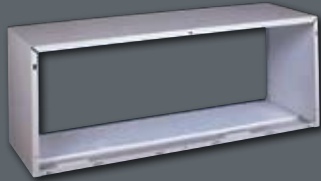

STANDARD GRILLE PXGA

Standard, stamped, anodized aluminum to resist chalking and oxidation.



DEEP WALL SLEEVE EXTENSION PXWE

A four-inch deep, anodized aluminum extension that attaches to the outside of the wall sleeve when the wall is greater than 13 1/4 inches thick (11 3/4" when a subbase is used, and 12 1/4" when a lateral duct is used).

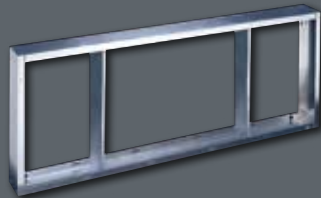

DIGITAL REMOTE THERMOSTATS

RT4 Digital, single stage thermostat. Hard wired with single speed fan.

RT5 Digital, single stage thermostat features high/low fan speed switch. Thermostat is hard wired and can be battery powered or unit powered. Features backlit display and multiple configuration modes. Mounts to wall for control of unit.



REMOTE THERMOSTAT ESCUTCHEON KIT PDXRT

Kit contains ten escutcheons that can be placed over the factory control buttons when a remote wall mounted thermostat is used. The escutcheon directs the guest to the wall thermostat for operation and retains the LED window to display error codes and diagnostic information.



REMOTE CONTROL PDXRC

One hand-held remote for control of PTAC unit. 2008 models and later only.



SLEEVE EXTENSION RETROFIT KIT PXSE

2 1/4" sleeve extension attached to the room side of the sleeve to allow for the installation of a PD-series Friedrich PTAC in a 11 1/2" deep T-series sleeve.

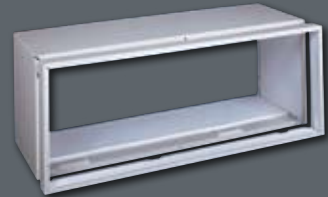

ARCHITECTURAL GRILLES

Architectural grilles that consist of heavy gauge 6063-T5 aluminum alloy

PXAA Clear extruded aluminum.
PXBG Beige acrylic enamel.
PXSC Available in custom colors.

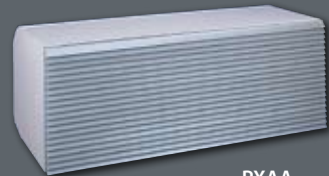

PXAA

DECORATIVE SUBBASE PXSB

Provides unit support for walls less than six inches thick. Includes leveling legs, side filler panels and mounting brackets for electrical accessories. Accepts circuit breaker, power disconnect switch and conduit kit.

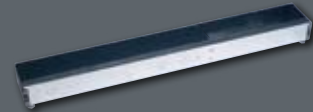

CONDENSATE DRAIN KIT PXDR10

Attaches to the bottom of the wall sleeve for internal draining of condensate or to the rear wall sleeve flange for external draining. Recommended for all units to remove excess condensate. Packaged in quantities of ten.

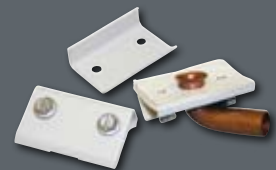

CONDUIT KIT WITH JUNCTION BOX PXJC

Hard wire conduit kit with junction box for 208/230V and 265V units (subbase not required). Kit includes a means of quick disconnect for easy removal of the chassis.

*Required for 265V installations.



POWER CORD RETROFIT PXPC 15/20/30

Replaces LCDI power cord on 230V models when unit is used with a subbase. PXPC15 is used with 15 amp (0 kW and 2.5 kW) units. PXPC20 is used with 20 amp (3.4 kW) units. PXPC30 is used with 30 amp (5.0 kW) units.



PDE Series Air Conditioner with ELECTRIC HEAT— COOLING PERFORMANCE



Model	Cooling Capacity BTU/Hr.	Electrical Characteristics (60 Hertz)			EER Energy Efficiency Ratio	Moisture Removal Pints /Hr.	Indoor CFM	Vent CFM	Chassis Shipping Weight Lbs.
		Volts	Amps	Watts					
PDE07K	7500/7300	230/208	2.9	615	12.2	2.1	250	60	123
PDE07R	7500	265	2.7	615	12.2	2.1	250	60	123
PDE09K	9200/9000	230/208	3.7	814	11.3	2.7	250	60	130
PDE09R	9200	265	3.5	814	11.3	2.7	250	60	130
PDE12K	12200/12000	230/208	5.1	1140	10.7	3.8	325	70	138
PDE12R	12200	265	4.7	1140	10.7	3.8	325	70	138
PDE15K	15000/14800	230/208	6.8	1579	9.5	5.5	350	70	143
PDE15R	15000	265	6.8	1579	9.5	5.5	350	70	143

PDH Series Heat Pump — HEATING/COOLING PERFORMANCE

Model	Cooling Capacity BTU/Hr.	Heating Capacity BTU/Hr.	Electrical Characteristics (60 Hertz)			EER Energy Efficiency Ratio	C.O.P.	Moisture Removal Pints /Hr.	Indoor CFM	Vent CFM	Chassis Shipping Weight Lbs.
			Volts	Amps	Watts						
PDH07K	7200/7000	6400/6200	230/208	3.0	595	12.1	3.3	2.1	250	60	123
PDH07R	7200	6400	265	2.7	595	12.1	3.3	2.1	250	60	123
PDH09K	9100/8900	8100/7900	230/208	3.9	805	11.3	3.0	2.7	250	60	130
PDH09R	9100	8100	265	3.4	805	11.3	3.0	2.7	250	60	130
PDH12K	12200/11800	10600/10400	230/208	5.1	1165	10.3	3.0	3.8	325	70	138
PDH12R	12000	10600	265	4.8	1165	10.3	3.0	3.8	325	70	138
PDH15K	14700/14300	13300/13100	230/208	6.8	1581	9.3	2.9	5.5	350	70	143
PDH15R	14700	13300	265	6.0	1581	9.3	2.9	5.5	350	70	143

PDE/PDH Series — ELECTRIC HEATING DATA

Model	Heating Capacity BTU/Hr.	Heater Watts	Voltage	Heating Current Amps	Minimum Circuit Ampacity	Branch Circuit Fuse Amps
PDE/PDH07K	8500/7000	2500/2050	230/208	11.4/10.4	14.1	15
PDE/PDH09K	11600/9500	3400/2780		15.3/13.9	19.0	20
PDE/PDH07R	8500	2500	265	9.8	12.2	15
PDE/PDH09R	11600	3400		13.2	16.4	20
PDE/PDH12K	8500/7000	2500/2050	230/208	11.4/10.4	14.1	15
	11600/9500	3400/2780		15.3/13.9	19.0	20
	17000/13900	5000/4090		22.3/20.3	27.8	30
PDE/PDH12R	8500	2500	265	9.8	12.2	15
	11600	3400		13.2	16.4	20
	17000	5000		19.5	24.2	30
PDE/PDH15K	11600/9500	3400/2780	230/208	15.3/13.9	19.0	20
	17000/13900	5000/4090		22.3/20.3	27.8	30
PDE/PDH15R	11600	3400	265	13.2	16.4	20
	17000	5000		19.5	24.2	30
PDE09KO	—	—	230/208	—	6.0	15
PDE12KO	—	—		—	7.6	15
PDE15KO	—	—		—	8.5	15

250 V Receptacles and Fuse Types			
AMPS	15	20	30
HEATER SIZE	0, 2.5 kW	3.4 kW	5.0 kW
RECEPTACLE			

Five-year warranty limited to installations in the United States, Puerto Rico, Mexico and Canada only. See warranty documentation for full details.



Friedrich

Friedrich Air Conditioning Co. | P.O. Box 1540 | San Antonio, TX 78295-1540 | (800) 541-6645 | fax (210) 357-4480 | www.friedrich.com