

FRIGIDAIRE

GALLERY.



Freezer

FGCH25M8L W

Manual Defrost
25 Cu. Ft. Chest



Product Dimensions

Height (Including Lid)	35"
Width	73-1/4"
Depth	29-1/2"

More Easy-To-Use Features

Bright Lighting

Our bright lighting makes it easy to see what's inside

Power-On Indicator Light

Know at a glance that your freezer is working.

Adjustable Temp Control

Defrost Water Drain

Lid Handle



ENERGY STAR®

Available in:



White
(W)

Signature Features

SpaceWise® Organization System

Heavy-duty dividers allow you to organize food storage like never before. System includes and accommodates pre-printed storage labels.

Store-More™ Capacity

Our large capacity freezer gives you room to store more.

Store-More™ Removable Basket

Convenient lift-out storage for easy access to most small frozen items or items that are most frequently accessed.

Lock with Pop-Out Key

Key is automatically ejected upon locking for maximum security.

Features	
Defrost	Manual
Adjustable Temperature Control	Yes
Interior Lighting	Bright
Store-More™ Removable Baskets	3
Food Organization System	Yes
Defrost Water Drain	Yes
Lid Handle	Yes
Lock with Pop-Out Key	Yes
Temp Alarm System	
Power On Light	Yes
Certifications	
ENERGY STAR®	Yes
CSA Rating	Household
Specifications	
Total Capacity (Cu. Ft.)	24.9
Annual Energy (kWH)	512
Annual Energy Cost (.1065/kWH)	\$55
Power Supply Connection Location	Bottom Rear
Voltage Rating	115V / 60Hz / 5A
Connected Load (kW rating) @ 115 Volts¹	.6
Amps @ 115 Volts	5
Minimum Circuit Required (Amps)	15
Shipping Weight (Approx.)	224 Lbs.

¹An electrical supply with grounded three-prong receptacle is required. The power supply circuit must be installed in accordance with current edition of National Electrical Code (NFPA 70) and local codes & ordinances.

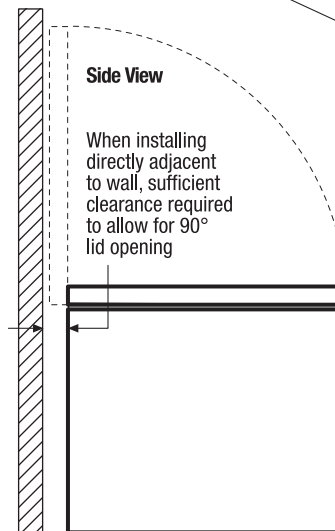
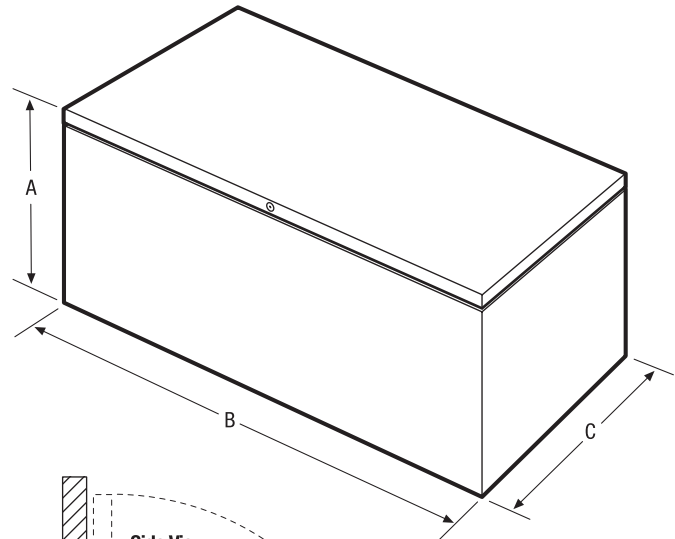

NOTE: For planning purposes only. Always consult local and national electric codes. Refer to Product Installation Guide for detailed installation instructions on the web at frigidaire.com.



Product Dimensions	
A - Height (Including Lid)	35"
B - Width	73-1/4"
C - Depth	29-1/2"
D - Height with Lid Open 90°	60-13/16"

Accessories information available on the web at frigidaire.com

FRIGIDAIRE

USA • 10200 David Taylor Drive • Charlotte, NC 28262 • 1-800-FRIGIDAIRE • frigidaire.com
CANADA • 5855 Terry Fox Way • Mississauga, ON L5V 3E4 • 1-800-265-8352 • frigidaire.ca

FGCH25M8L 09/10

© 2010 Electrolux Home Products, Inc.

Specifications subject to change.
Printed in the U.S.A.