

Viking Use & Care Manual

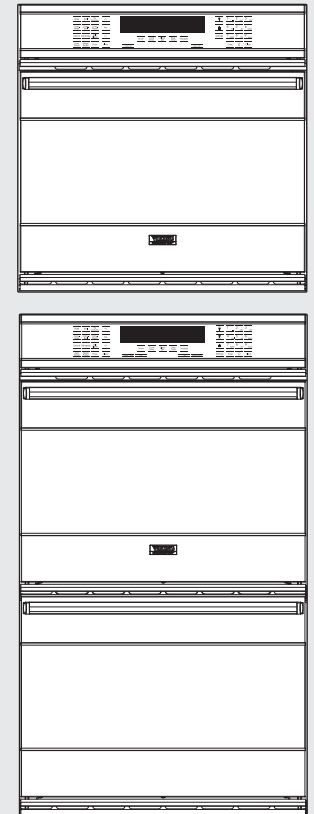

Viking Range Corporation
111 Front Street
Greenwood, Mississippi 38930 USA
(662) 455-1200

For product information,
call 1-888-VIKING1 (845-4641)
or visit the Viking Web site at
vikingrange.com



Designer Series Built-In Electric
Touch Control Single and Double Ovens

Congratulations

Your purchase of this product attests to the importance you place upon the quality and performance of the major appliances you use. With minimal care, as outlined in this guide, this product is designed to provide you with years of dependable service. Please take the few minutes necessary to learn the proper and efficient use and care of this quality product.

Some of the key features of this appliance include:

- A broad range of baking and broiling modes—up to 11 cooking modes in all—to make even your most challenging baking projects a success.
- A two-speed convection fan that allows you to cook foods more thoroughly and evenly—even when baking large quantities.
- Four convection modes offering greater air circulation to shorten cooking times and cook foods more evenly.
- Dual broiling elements producing intense radiant heat for faster broiling and a larger coverage area.
- Three broiling modes including a new low-broil mode for delicate broiling and top-browning.
- A halogen lighting system to provide more light with less glare.
- A concealed bake element for easier cleaning.
- Five adjustable rack positions to accommodate all your baking needs.

Your complete satisfaction is our ultimate goal. If you have any questions or comments about this product, please contact the dealer from whom you purchased it, or contact our Consumer Support Center at 1-888-VIKING1 (845-4641).

We appreciate your choosing a Viking Range Corporation product and hope that you will again select our products for your other major appliance needs. For more information about the complete and growing selection of Viking products, contact your dealer or visit us online at vikingrange.com

Table of Contents

Getting Started

Warnings & Important Safety Information	4
---	---

Product Controls

Before Using Oven	12
Setting the Clock	13
Oven Control Panel	14
Oven Features	16
Clocks and Timers	17
Oven Settings	21

Operation

Using the Oven	30
Preheat	30
Meat Probe Function	30
Rack Positions	32
Conventional and Convection Cooking	33
Condensation	34
Pan Placement Tips	35
Baking	36
BAKE (Two-Element Bake)	36
CONV BAKE (Convection Bake)	36
TRU CONV (TruConvect™)	37
Bake Instructions	38
Solving Baking Problems	43
Roasting	44
CONV ROAST(Convection Roast)	44
Roast Instructions	47
Broiling	51
CONV BROIL(Convection Broil)	51
HI BROIL	51
MED BROIL	51
LOW BROIL	51
Broiling Instructions	53
Warming Modes	56
Convection Dehydrate	56
Convection Defrost	57
Proofing	57

Product Care

Cleaning and Maintenance	58
Self-Clean Cycle	60
Replacing Oven Lights	62
Troubleshooting	63
Error Handling	64
Service Information	65

IMPORTANT—Please Read and Follow

Warning and Important Safety Instructions appearing in this manual are not meant to cover all possible conditions and situations that may occur. Common sense, caution, and care must be exercised when installing, maintaining, or operating the appliance.

ALWAYS contact the manufacturer about problems or conditions you do not understand.

Recognize Safety Symbols, Words, Labels

⚠ DANGER
Hazards or unsafe practices which WILL result in severe personal injury or death
⚠ WARNING
Hazards or unsafe practices which COULD result in death or severe personal injury
⚠ CAUTION
Hazards or unsafe practices which COULD result in minor personal injury.
All safety messages will identify the hazard, tell you how to reduce the chance of injury, and tell you what can happen if the instructions are not followed.

Read and follow all instructions before using this appliance to prevent the potential risk of fire, electric shock, personal injury or damage to the appliance as a result of improper usage of the appliance. Use appliance only for its intended purpose as described in this manual.

To ensure proper and safe operation: Appliance must be properly installed and grounded by a qualified technician. **DO NOT** attempt to adjust, repair, service, or replace any part of your appliance unless it is specifically recommended in this manual. All other servicing should be referred to a qualified servicer.

KEEP THESE INSTRUCTIONS FOR FUTURE REFERENCE.

IMPORTANT—Please Read and Follow

⚠ WARNING

DO NOT use commercial oven cleaners inside the oven. Use of these cleaners can produce hazardous fumes or can damage the porcelain finishes.

⚠ WARNING

NEVER cover any slots, holes or passages in the oven bottom or cover an entire rack with materials such as aluminum foil. Doing so blocks air flow through the oven and may cause carbon monoxide poisoning. Aluminum foil linings may also trap heat, causing a fire hazard.

⚠ WARNING



To avoid risk of property damage, personal injury or death; follow information in this manual exactly to prevent a fire or explosion. **DO NOT** store or use gasoline or other flammable vapors and liquids in the vicinity of this or any appliance.

IMPORTANT—Please Read and Follow

To Prevent Fire or Smoke Damage

- Be sure all packing materials are removed from the appliance before operating it.
- Keep area around appliance clear and free from combustible materials, gasoline, and other flammable vapors and materials.
- Many aerosol-type spray cans are **EXPLOSIVE** when exposed to heat and may be highly flammable. Avoid their use or storage near an appliance.
- Many plastics are vulnerable to heat. Keep plastics away from parts of the appliance that may become warm or hot.
- Combustible items (paper, plastic, etc.) may ignite and metallic items may become hot and cause burns. **DO NOT** leave oven unsupervised when drying herbs, breads, mushrooms, etc., as this may create a fire hazard.

In Case of Fire

Turn off appliance to avoid spreading the flame.

- Smother fire or flame by closing the oven door.
- **DO NOT** use water on grease fires. Use baking soda, a dry chemical or foam-type extinguisher to smother fire or flame.

Child Safety

- **NEVER** leave children alone or unsupervised near the appliance when it is in use or is still hot.
- **DO NOT** store items of interest to children over the unit. Children climbing to reach items could be seriously injured.
- Children must be taught that the appliance and utensils in it can be hot. Let hot utensils cool in a safe place, out of reach of small children. Children should be taught that an appliance is not a toy. Children should not be allowed to play with controls or other parts of the appliance.

IMPORTANT—Please Read and Follow

Cooking Safety

- Use dry, sturdy pot-holders. Damp pot-holders may cause burns from steam. Dish towels or other substitutes should **NEVER** be used as potholders because they can get caught on appliance parts.
- Loose-fitting or hanging garments should never be worn while using the appliance. **DO NOT** drape towels or materials on oven door handles. These items could ignite and cause burns.
- **ALWAYS** place oven racks in the desired positions while oven is cool. Slide oven rack out to add or remove food, using dry, sturdy pot-holders. **ALWAYS** avoid reaching into the oven to add or remove food. If a rack must be moved while hot, use a dry pot-holder.
- **ALWAYS** turn the oven off at the end of cooking.
- **DO NOT** heat unopened food containers; buildup of pressure may cause the container to explode and result in injury.
- Use care when opening the oven door. Let hot air or steam escape before moving or replacing food.
- **NEVER** use aluminum foil to cover oven racks or oven bottom. This could result in risk of electric shock, fire, or damage to the appliance. Use foil only as directed in this guide.
- **PREPARED FOOD WARNING:** Follow food manufacturer's instructions. If a plastic frozen food container and/or its cover distorts, warps, or is otherwise damaged during cooking, immediately discard the food and its container. The food could be contaminated.

Heating Elements

- **NEVER** touch oven heating elements, areas near elements, or interior surfaces of oven.
- Heating elements may be hot even though dark in color. Areas near elements and interior surfaces of an oven may become hot enough to cause burns.
- During and after use, **DO NOT** touch or let clothing or other flammable materials contact heating elements, areas near elements, or interior surfaces of oven until they have had sufficient time to cool.

Self-Clean Oven

- Clean only parts listed in this guide. **DO NOT** clean door gasket. The door gasket is essential for a good seal. Care should be taken not to rub, damage, or move the gasket. **DO NOT** use oven cleaners of any kind in or around any part of the self-clean oven.
- Before self-cleaning the oven, remove broiler pan, oven racks and other utensils and wipe up excessive spill-overs to prevent excessive smoke, flare-ups or flaming.
- This oven features a cooling fan which operates automatically during a clean cycle. If the fan does not turn on, cancel the clean operation and contact an authorized servicer.

IMPORTANT—Please Read and Follow

Important Safety Notice and Warning

The California Safe Drinking Water and Toxic Enforcement Act of 1986 (Proposition 65) requires the Governor of California to publish a list of substances known to the State of California to cause cancer or reproductive harm, and requires businesses to warn customers of potential exposures to such substances. Users of this appliance are hereby warned that when the oven is engaged in the self-clean cycle, there may be some low-level exposure to some of the listed substances, including carbon monoxide. Exposure to these substances can be minimized by properly venting the oven to the outdoors by opening the windows and/or door in the room where the appliance is located during the self-clean cycle.

Important notice regarding pet birds:

NEVER keep pet birds in the kitchen or in rooms where the fumes from the kitchen could reach. Birds have a very sensitive respiratory system. Fumes released during an oven self-cleaning cycle may be harmful or fatal to birds. Fumes released due to overheated cooking oil, fat, margarine and overheated non-stick cookware may be equally harmful.

About Your Appliance

⚠ WARNING

NEVER use appliance as a space heater to heat or warm a room to prevent potential hazard to the user and damage to the appliance. Also, **DO NOT** use the oven as a storage area for food or cooking utensils.

⚠ WARNING

To prevent possible damage to cabinets and cabinet finishes, use only materials and finishes that will not discolor or delaminate and will withstand temperatures up to 194°F (90°C). Heat and moisture resistant adhesive must be used if the product is to be installed in laminated cabinetry. Check with your builder or cabinet supplier to make sure that the materials meet these requirements.

- For proper oven performance and operation, **DO NOT** block or obstruct the oven vent duct located on the right side of the air grille.
- Avoid touching oven vent area while oven is on and for several minutes after oven is turned off. When the oven is in use, the vent and surrounding area become hot enough to cause burns. After oven is turned off, **DO NOT** touch the oven vent or surrounding areas until they have had sufficient time to cool.

IMPORTANT—Please Read and Follow

- Other potentially hot surfaces include oven vent, surfaces near the vent opening, oven door, areas around the oven door, and oven window.
- The misuse of oven doors (e.g. stepping, sitting, or leaning on them) can result in potential hazards and/or injuries.

⚠ WARNING



ELECTRICAL SHOCK HAZARD

DO NOT touch a hot oven light bulb with a damp cloth as the bulb could break. Should the bulb break, disconnect power to the appliance before removing bulb to avoid electrical shock.

⚠ WARNING



ELECTRICAL SHOCK HAZARD

Disconnect the electric power at the main fuse or circuit breaker before replacing bulb.

⚠ WARNING



BURN OR ELECTRICAL SHOCK HAZARD

Make sure all controls are "OFF" and oven is COOL before cleaning. Failure to do so can result in burns or electrical shock.

⚠ WARNING

This appliance features a self-cleaning cycle. During this cycle, the oven reaches elevated temperatures in order to burn off soil and deposits. A powder ash residue is left in the bottom of the oven after completion of the self-clean cycle.

Note: DO NOT use commercial oven cleaners inside the oven. Use of these cleaners can produce hazardous fumes or can damage the porcelain finishes. **DO NOT** line the oven with aluminum foil or other materials. These items can melt or burn during a self-clean cycle, causing permanent damage to the oven.

IMPORTANT—Please Read and Follow

⚠ WARNING



BURN HAZARD

When self-cleaning, surfaces may get hotter than usual. Therefore, children should be kept away.

⚠ WARNING

To avoid sickness and food waste when using automatic time baking:

- **DO NOT** use foods that will spoil while waiting for cooking to start, such as dishes with milk or eggs, cream soups, custards, fish, pork, poultry, or foods with stuffing.
- Any food that has to wait for cooking to start should be very cold or frozen before it is placed in the oven.
- **DO NOT** use foods containing baking powder or yeast with automatic time baking. They will not rise properly.
- **DO NOT** allow food to remain in the oven for more than 2 hours after the end of the cooking cycle.
- To avoid sickness and food waste, **DO NOT** allow defrosted food to remain in the oven for more than 2 hours.

⚠ CAUTION



DO NOT touch the exterior portions of the oven after self-cleaning cycle has begun, since some parts become extremely hot to the touch!

During the first few times the self-cleaning feature is used, there may be some odor and smoking from the “curing” of the binder in the high-density insulation used in the oven. When the insulation is thoroughly cured, this odor will disappear. During subsequent self-cleaning cycles, you may sense an odor characteristic of high temperatures.

KEEP THE KITCHEN WELL-VENTED DURING THE SELF-CLEAN CYCLE.

⚠ CAUTION

DO NOT store items of interest to children over the unit. Children climbing to reach items could be seriously injured.

IMPORTANT—Please Read and Follow

⚠ CAUTION



BURN HAZARD

The oven door, especially the glass, can get hot. **Danger of burning: DO NOT touch the glass!**

⚠ CAUTION

To avoid sickness and food waste, **DO NOT** allow defrosted food to remain in the oven for more than 2 hours.

⚠ CAUTION

You must carefully check the food during the dehydration process to ensure that it does not catch fire.

⚠ NOTICE

The cooling fan should be operating when the unit is in operation. If you notice the cooling fan is not operating or you observe unusual or excessive noise coming from the cooling fan, contact a Viking Authorized Service Center before continuing operation. Failure to do so can result in damage to the oven or surrounding cabinets.

⚠ NOTICE

Avoid any damage to oven vents. The vents need to be unobstructed and open to provide proper airflow for optimal oven performance.

⚠ NOTICE

DO NOT turn the Temperature Control on during defrosting. Turning the convection fan on will accelerate the natural defrosting of the food without the heat.

Before Using Oven

Oven

Important! Before first use, wipe interior with soapy water and dry thoroughly. Then set the oven selector to "BAKE", the thermostat to 350°F, and operate for an hour.

All models include:

- A broad range of baking and broiling modes—up to 11 cooking modes in all—to make even your most challenging baking projects a success.
- A two-speed convection fan that allows you to cook foods more thoroughly and evenly—even when baking large quantities.
- Four convection modes offering greater air circulation to shorten cooking times and cook foods more evenly.
- Dual broiling elements producing intense radiant heat for faster broiling and a larger coverage area.
- Three broiling modes including a new low-broil mode for delicate broiling and top-browning.
- A halogen lighting system to provide more light with less glare.
- A concealed bake element for easier cleaning.
- Five adjustable rack positions to accommodate all your baking needs.

Setting the Clock

Setting the Clock

The time-of-day must be set before any other program can be used. When your oven is first connected to the power in your home, the timer display will show 12:00.



To program the Time-Of-Day:

1. Press either the "UPPER OVEN" or "LOWER OVEN" button.
2. Press the "CLOCK SET" button. The clock will begin to flash. The word "CLOCK" will be lit on the display.
3. Type in the correct time on the electronic number keypad.
4. Press the "CLOCK SET" button again. The clock is now set.

Alternate method:

1. Press either the "UPPER OVEN" or "LOWER OVEN" button.
2. Press the "CLOCK SET" button. The clock will begin to flash. The word "CLOCK" will be lit on the display.
3. Use the up and down arrows to change the current time.

	Press and Release	Press and Hold
▲	Time increases by 1 minute	Time increases by 10 minutes
▼	Time decreases by 1 minute	Time decreases by 10 minutes

4. Press the "SET" button on the temperature control or the "CLOCK SET" button on the electronic timing center. The clock is now set.

Note: The time-of-day cannot be changed while there is a bake hours or start time cycle programmed into the timer.

Oven Control Panel

Oven Control Panel

Oven Function and Temperature Controls

Each oven function has a separate setting.
(See descriptions)
The SET control up and down arrows can be used to set any temperature from 150° F (65.6° C) to 550° F (287.8° C).

Electronic Timing Center

The electronic timing center is used to program and control all timing functions.

IMPORTANT—The time-of-day must be set before any other program can be used.

Oven Selector Controls

The oven selector controls are used to turn the upper or lower oven on and off.

Electronic Keypad Entry

The electronic keypad entry is used to program and control all oven functions.

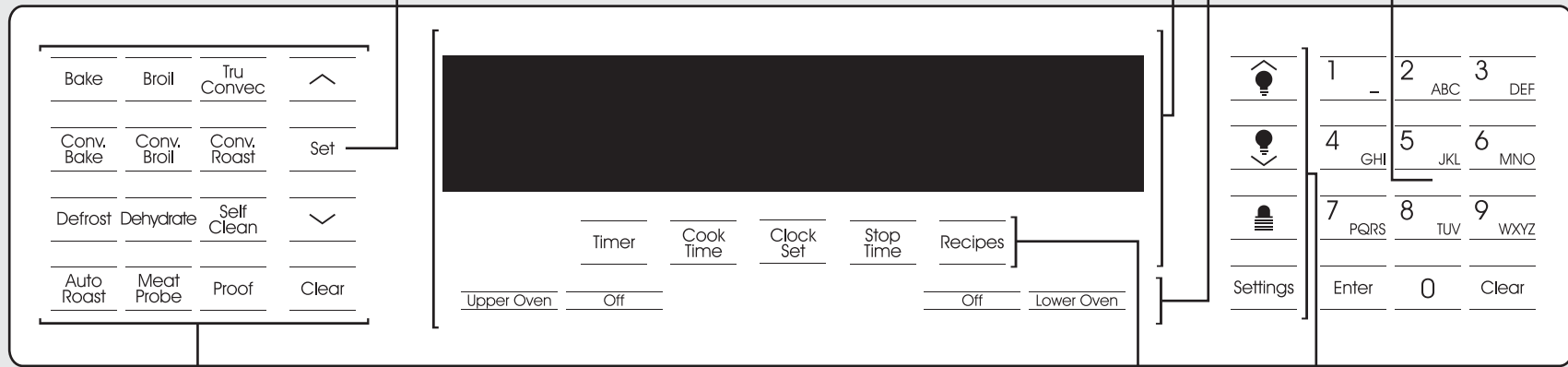

Oven Selector Options

Bake

Conventional, single-rack baking (breads, cakes, cookies, pastry, pies, entrees, vegetables)

Convection Bake

Multi-rack baking for heavier or frozen foods (e.g., frozen pies, pizzas, entrees, vegetables)

Defrost

Natural defrosting of food using fan without heat

Auto Roast

Automatic searing of the outside of meats; simplifies roasting

Broil

Three conventional broil settings for cuts of flat pieces of meat or meat 1-2 inches thick

Convection Broil

Faster than regular broiling with less smoke generation for thicker meats

Dehydrate

Using the convection fan over a period of time, water is removed from food by evaporation

Meat Probe

An audible alarm sounds when the internal temperature of the meat being roasted is reached

TruConvec™

Multi-rack baking for breads, cakes, cookies (up to 6 racks of cookies at once)

Convection Roast

Roasting whole turkeys, whole chickens, hams, etc.

Self-Clean

A self-cleaning cycle using high heat to burn off soils and deposits

Proof

Creates an optimal environment for the rising of yeast in many kinds of dough

Recipes

Accesses, programs, and saves cooking cycles from favorite recipes

Oven Light Controls

Controls the interior lights in the upper and lower ovens

Oven Lock

Childproofing feature preventing the controls from being activated when the oven is not in use

Settings

Accesses custom features such as display brightness, Sabbath mode, and tones

Note: DDOE305T model control panel shown.

Oven Features

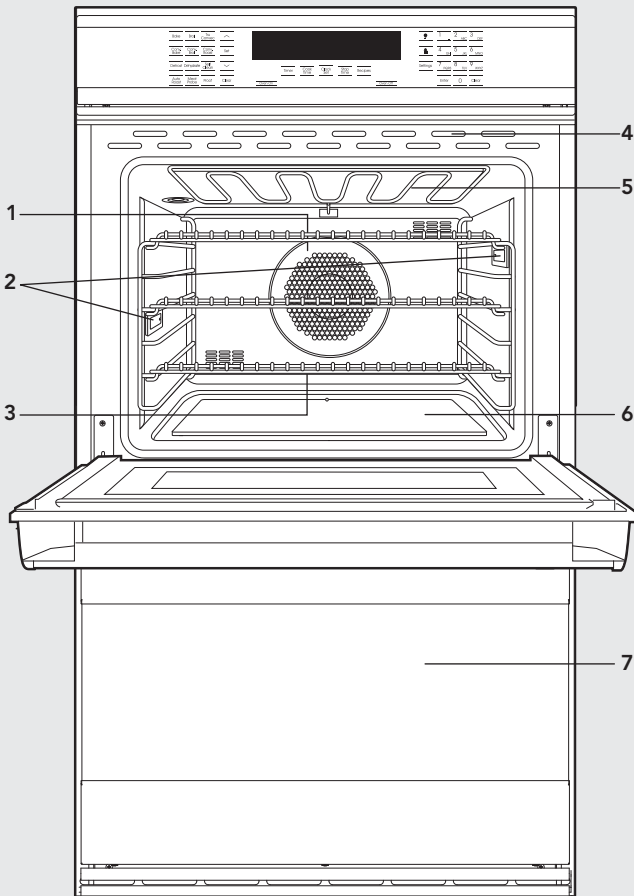

- | | |
|--|---|
| 1. TruConvec™ element (behind baffle) | 4. Model/Serial number plate (behind vents) |
| 2. Oven light | 5. Broil element |
| 3. Oven racks (three upper, three lower) | 6. Bake element |
| | 7. Lower oven |

Clocks and Timers

Electronic Timing Center

The Electronic Timing Center is used to program and control all timing functions on your Viking appliance. It has four display and programming modes that are activated by the four push buttons. Both the timer and the Cook Time/Stop Time modes can be used to time cooking periods. These features can even be used at the same time when both ovens are in use. For example, you can time-bake a casserole in the upper oven using the Cook Time/Stop Time mode, while broiling in the lower oven using the timer. One oven can also be cleaned while timing foods in the other oven using the timer.



Timer Alarm

- At the end of a program, the alarm will consist of three beeps, followed by two beeps every 10 seconds until the "CLEAR" button is pressed.
- Whenever a valid function key is pressed or when a control function starts automatically, one beep will sound.
- When an invalid function key is pressed, two beeps will sound.

Clocks and Timers

Setting the Timer

The timer is designed for accurate timing and is ideal for baking delicate items such as biscuits, cookies, and popovers, and for precise broiling. The timer can be used for timing up to 12 hours. When setting the timer, the time displayed will decrease in 1 minute increments. When the timer counts down to 1 minute, the timer alarm will give one short beep and the display will change to seconds. When the timer reaches 0:00, the alarm will give a long beep.

To set the Timer:

1. Press the "TIMER" button. The timer will display "0:00" and the word "TIMER."
2. Type in the desired duration time on the electronic number keypad.
3. The timer will start automatically. (To cancel the entry, press the "CLEAR" button on the left side of the control panel before the count down begins and the time is still flashing.)
4. The timer is now set.

Alternate method:

1. Press the "TIMER" button. The timer will display "0:00" and the word "TIMER" will be lit on the display.

	Press and Release	Press and Hold
▲	Time increases by 1 minute	Time increases by 10 minutes
▼	Time decreases by 1 minute	Time decreases by 10 minutes

2. Use the up and down arrows to set the timer.
3. Press "SET" or "TIMER" to program the timer. (To cancel the entry, press the "CLEAR" button on the left side of the control panel.)
4. The timer is now set.

Clocks and Timers

Cook Time and Stop Time

With the Viking oven, you can choose what times you need to start and stop cooking your food. The cook time and stop time functions allow you to program your preferences.

Here's how it works:

It is 2:00 PM and you would like to have your dinner ready at 6:00 PM. By programming your oven with a 2-hour cook time and a 6:00 PM stop time, your oven will delay cooking until 3:50 PM. At 3:50, the oven will begin preheating. At 4:00 PM, the oven will begin its 2-hour cook time.

Cook Time and Stop Time facts:

Both ovens can be set individually for cook time and stop time functions.

To set Cook Time:

1. Select "UPPER OVEN" or "LOWER OVEN".
2. Select an oven function and temperature before setting Cook Time and Stop Time functions.
3. Press "COOK TIME" and the display will flash "0:00" and "COOK TIME" will be lit below.
4. Use numeric keyboard to enter the amount of time needed for cooking.
5. After the time is entered, the display will show "COOK TIME" under the timer field. (To cancel the entry, press the "CLEAR" button on the left side of the control panel.)
6. Press "SET" or "ENTER" if the cook time is correct. Cook time is set.

Note: To cancel cook time during its cycle, press "COOK TIME" and then press the "CLEAR" button on the left side of the oven control. Cooking will continue if the oven is on.

Clocks and Timers

Cook Time and Stop Time (cont.)

To set Stop Time:

1. Set Cook Time, following the steps provided in the previous section.
2. Press "STOP TIME" and "STOP TIME" will be lit on the display.
3. Use numeric keyboard to enter the time you want to stop for cooking.
4. After the time is entered, the display will flash the time. (To cancel stop time, press the "CLEAR" button on the left side of the control panel.)
5. Press "SET" or "STOP TIME" if the stop time is correct. Stop time is set and will begin when the oven is preheated.

Note: Display will show cook time and stop time. If you have entered a time incorrectly, you will hear a long beep and the display will not change.

Note: To cancel stop time during its cycle, press "STOP TIME" and then press the "CLEAR" button on the left side of the oven control. Cooking will continue if the oven is on.

When Stop Time has been reached:

1. Your oven will sound three beeps, and "HOLD" will appear on the display.
 - The oven will stay at 150°F in hold mode for 2 hours.
 - After 2 hours, the oven will sound four long beeps and shut off.
2. Press "OFF" to turn off the oven manually.

Oven Settings

Settings

Use this function to access, program, and customize special features of your oven. Special features include tones, timeouts, display brightness, and the Sabbath mode.



Brightness

This mode offers users the ability to decrease or increase the intensity of the brightness of the electronic display panel. Users may choose between four levels of brightness: 25%, 50%, 75%, and 100%.

To customize Brightness level:

1. Press "SETTINGS." Settings menu will appear in display.
2. Press the up or down arrows until "BRIGHTNESS: 100%" appears in the display. (The % shown is the current brightness level.)
3. Press "ENTER" to change brightness level. Current value will flash.
4. Move up and down arrows to select desired brightness level.
5. Press "ENTER" to confirm brightness level.
6. To exit the Settings menu, press "SETTINGS."

Degree Format

The oven has been preset to the Fahrenheit temperature scale. With this feature, users can switch to the Celsius temperature scale.

To change Degree Format to Celsius:

1. Press "SETTINGS." Settings menu will appear in display.
2. Press the up or down arrows until "DEGREES: FAHRENHEIT" appears in the display.
3. Press "ENTER" to change degree format. Current value will flash.
4. Use arrow keys to select "CELSIUS."
5. Press "ENTER" again to set degree format.
6. To exit the settings menu, press "SETTINGS."

Oven Settings

Tones

This function allows you to define the duration of tones and the number of tones for different events. Your oven is programmed with different audible tones as demonstrated by the following chart:

Description of tone	Used in...	Number of tones	Duration (seconds)
1 Minute Left	Min/Sec or Cook Timer	1	1
Autostart	Cooking mode or timer starts without pressing Set or Enter	2	0.1
End of Hold	Cook Time/Stop Time	4	1
Timer Expired	Min/Sec or Cook Timer	3	1
Failure	RTD error/Latch error	5	1
Invalid Entry	Error in programming	3	0.1
Periodic Reminder	After cooking mode finishes or during programming to prompt action by user	1	0.1
Key Press	Information Entry	1	0.1
Invalid Key	Information Entry	3	0.1
Repeat Key	Information Entry	0	0
Oven Light Off	Turning light off	2	0.1
Oven Light On	Turning light on	1	0.1
Panel is Locked	Information Entry	3	0.1
Setpoint Reached	Cooking Modes	1	1
Meat Probe	Roasting Modes	3	1
Meat Probe within 10°	Roasting Modes	2	1
Searing Time Reached	Roasting Modes	3	1
Start Time Reached	Various Cooking Modes	1	1
Panel is Unlocked	Information Entry	2	0.1

Oven Settings

Tones (cont.)

To change the frequency and/or duration of any of the above tone signals:

1. Press "SETTINGS." Settings menu will appear in display.
2. Press the up or down arrows until "TONES..." appears in the display.
3. Press "ENTER," and "RESTORE FACTORY DEFAULTS: NO" appears on the display.
4. Scroll up or down using the arrow keys to find the Tone you would like to change and press "ENTER." Display will flash and appear as follows:

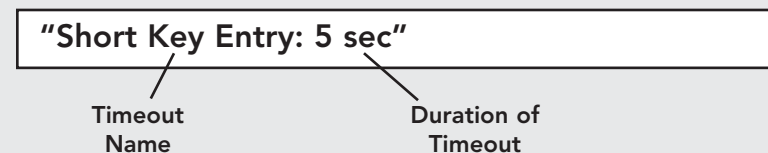

5. Press "ENTER," and the "1 x 1 SEC" value will flash.
6. Using the numeric keyboard, enter the number and the duration of tones desired. The number of tones can be a value from 0 to 9. The duration of tones is measured in tenths of a second. You can enter a number from 0.0 to 9.0.
7. Press "ENTER" when finished. The tone is customized to your preference. At this point the oven plays the new tone. If you do not like it, return to Step 1 to adjust the tone.
8. To exit the settings menu, press "SETTINGS."

Oven Settings

Tone Volume

To change the Tone Volume setting:

1. Press "SETTINGS." Settings menu will appear on display.
2. Press the up or down arrows until "TONES ..." appears on the display.
3. Press "ENTER," and "RESTORE FACTORY DEFAULTS: NO" appears on the display.
4. Press the down arrow until "VOLUME: HIGH" appears on the display.
5. Press "ENTER" to change volume level. The current value will flash.
6. Use up and down arrows to select the desired volume level. Setting options are "HIGH", "LOW" and "OFF."
7. Press "ENTER" to confirm volume level setting.
8. To exit the settings menu, press "SETTINGS."

Timeouts

Your oven is programmed with four preset timeouts that allow the user varying amounts of time to key in entries to the oven control display. The amount of time allowed the user to respond to a programming prompt is called a timeout. If the user fails to make an entry during the timeout period, the oven will default to its previous mode.

If you find that the amount of time allowed for programming does not meet your needs, you can redefine the limits of any of the four timeouts. The chart below defines the four timeouts, their duration, and when they're used:

	Description of timeout	Used in...	Duration (seconds)
1	Short entry	Cycle setpoint, meat probe setpoint, and setting the minute/second timer	5
2	Medium entry	Entering cook/stop times, setting time, selecting functions and settings	10
3	Long entry	Selecting, editing, and entering recipes	30
4	Lock key hold time	Locking the Oven	3

Oven Settings

Timeouts (cont.)

To change the duration of a Timeout:

1. Press "SETTINGS." Settings menu will appear in display.
2. Press the up or down arrows until "TIMEOUTS..." appears in the display.
3. Press "ENTER," and "RESTORE FACTORY DEFAULTS: NO" will appear on the display.

"Short Key Entry: 5 sec"

Timeout Name

Duration of Timeout

4. Scroll up or down using the arrow keys to find the timeout you would like to change and press "ENTER." Display will flash and appear as follows:
5. Using the numeric keyboard, enter the number of seconds desired.
6. Press "ENTER" when finished. Timeout is customized to your preference.
7. To exit the settings menu, press "SETTINGS."

Clock Format

This feature allows users to choose a 12-hour or 24-hour format for the clock display.

To program the Clock Format:

1. Press "SETTINGS." Settings menu will appear in display.
2. Press up and down arrows until "12 or 24 HOURS: 12" appears in the display.
3. Press "ENTER" and the current setting will flash in the display.
4. Use arrow keys to choose "12" or "24."
5. Press "ENTER" again to accept desired clock format.
6. To exit the settings menu, press "SETTINGS."

Oven Settings

Sabbath Mode

This mode offers users belonging to religions with “no work” restrictions to program their ovens to comply with the Sabbath requirement. When the oven door is opened in Sabbath mode, the oven light stays off while the convection fan and heating elements remain on.

To program the Sabbath Mode:

1. Press “SETTINGS.” Settings menu will appear in display.
2. Press up or down arrows until “SABBATH: NO” appears in the display.
3. Press “ENTER,” and “NO” will flash on display.
4. Use arrow keys to choose “YES” or “NO.”
5. Press “ENTER” again to accept Sabbath mode.
6. To exit the Settings menu, press “SETTINGS.”

Showroom Mode

This mode allows the oven to be hooked up to a 120 volt electrical supply for display or showroom mode purposes. In this mode, the electronic display/controls and oven lights will function but the heating elements and convection fan will NOT function.

To program the Showroom Mode:



1. Press “SETTINGS”. Settings menu will appear in display.
2. Use the down arrow to scroll to “TIMEOUTS”.
3. At “TIMEOUTS” mode, hold the down arrow for 5 seconds.
4. Use the down arrow to scroll to “SHOWROOM”.
5. Push “SET” button.
6. Use the up arrow to toggle between “YES” and “NO”.
7. Select “YES” and push “SET” button.
8. To exit the “SETTINGS” menu, press “SETTINGS”.

Oven Settings

Lock and Unlock

This child protection function prevents the oven controls from being activated when the oven is not being used.



To Lock the ovens:

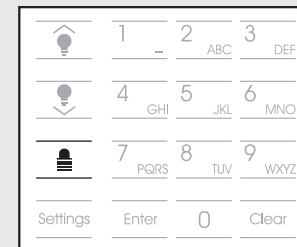

1. Press  on the right side of your oven control panel. Display shows “HOLD FOR LOCK.”
2. When locked, three short beeps will sound and the display will show “PANEL IS LOCKED.”
3. To unlock a double oven, press and hold “UPPER OVEN” or “LOWER OVEN” for 3 seconds. When unlocked, two short beeps will sound and the display will show “PANEL IS UNLOCKED.”
4. To unlock a single oven, press and hold the  and simultaneously press and hold the “OVEN ON” button for 3 seconds. When unlocked, two short beeps will sound and the display will show “PANEL IS UNLOCKED”.



Interior Oven Lights (Two Pads)

Each oven has an interior light that can be turned off and on using the designated buttons on the oven control panel.

Press  or  to turn on the light in the upper or lower oven. (You will hear a beep to signal that the light is on.)

Press  or  again to turn off the light in the upper or lower oven. (You will hear two beeps to signal that the light is off.)

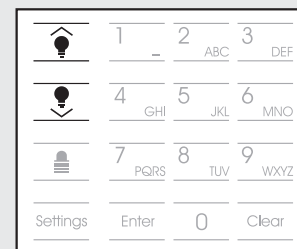

Oven Settings

This Recipe Function accesses, programs, and saves cooking cycles from favorite recipes.

Entering Recipe Name:

This function programs and saves up to 100 cooking cycles from favorite recipes. Recipe

names are entered on the numeric keypad on the right side of the keyboard. When a key with several letters is pressed for the first time, the first letter is entered. If the same key is pressed a second time, the second letter is entered, and so on. For example, if the key "2 ABC" is pressed once, the letter 'A' is entered. If the key is pressed two times, the letter 'B' is entered. If the key is pressed three times, the letter 'C' is entered. If the key is pressed four times, the digit '2' is entered. Then lower case 'a', then 'b', then 'c', then 'A' again, and so on.

If nothing is pressed within 2 seconds, the cursor moves to the next position. To return to the previous position use the right "CLEAR" key. Pressing the '1' key will also move the cursor to the next position as well as entering a space.

When subsequent characters are entered, the case and type of the character matches the previous character. For example, if the previous character is a digit, then pressing the "2 ABC" key once would result in the digit '2'. If the previous character is a lower case letter, then pressing the "2 ABC" key once would result in the letter 'a'.

Entering a new Recipe:

1. Press "RECIPES" twice.
2. "NAME" should be flashing.
3. Enter a recipe name using numeric keypad.
4. Press a Bake function key.
5. Use arrow or numeric keypad to set the temperature.
6. If needed, hit "COOK TIME" key to enter cook time.
7. Press "SET" or "ENTER" to save the recipe.

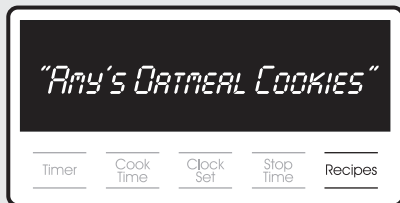

Oven Settings

Editing a Recipe:

1. In the recipe list mode, press "RECIPES."
2. Recipe name should be flashing.
3. Use the following instructions to make changes:
 - To change recipe name, use numeric keypad.
 - To change cycle, press a cycle key.
 - To change temperature, press an arrow key.
 - To change cook time, press the "COOK TIME" key.
4. Press "SET" or "ENTER" to save the recipe.

Using a Recipe:

1. To use a programmed recipe, scroll through the list and press "ENTER" or "SET" to select and start the program.

Deleting a Recipe:

1. In the recipe list mode, press "RECIPES."
2. Recipe name should be flashing.
3. Use right "CLEAR" key to erase the name.
4. Press "SET" or "ENTER."

Using the Oven

Preheat

For best results, it is extremely important that you preheat your oven to the desired cooking temperature before placing food items in the oven to begin cooking. In many cooking modes, partial power from the broiler is used to bring the oven to the preheat temperature. Therefore, placing food items in the oven during preheat mode is not recommended. The Viking Rapid Ready™ Preheat System is engineered so that the oven is brought to the desired set temperature in a manner which will provide the optimum cooking environment based on the selected cooking mode in the shortest possible time.

Meat Probe Function

The meat probe takes the guesswork out of roasting by cooking foods to the ideal internal temperature. An audible alarm sounds when the internal temperature of the meat being roasted is reached.

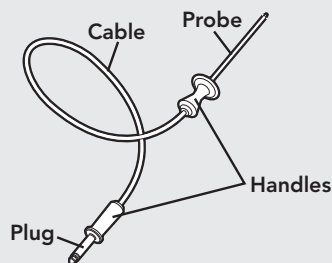

Using the Oven

To Set the Automatic Probe Function

Bake	Broil	Tru Convec	^
Conv. Bake	Conv. Broil	Conv. Roast	Set
Defrost	Dehydrate	Self Clean	v
Auto Roast	Meat Probe	Proof	Clear

- A cooking mode must be selected before setting meat probe.
 - Bake, Convection Bake, Convection Roast, TruConvec™, and Convection Broil are the cooking modes that can be used with the meat probe function.
 - Set the internal temperature about 10°F lower than the actual desired internal temperature. The meat will continue to cook when removed from the oven and will reach desired internal temperature while "standing."
1. Insert probe into the meat and slide into oven. Double oven models have a meat probe in the upper oven only.
 2. Plug the probe into the outlet located on the left interior wall of the oven and close the oven door.
 3. Press the "MEAT PROBE" button on the control panel. The display will show "SET PROBE" and flashing preset temperature.
 4. The preset temperature of 160°F or a stored temperature will be displayed on the electronic timing center. If you desire this temperature, the probe mode will begin after 10 seconds.
 5. To set another temperature, use the keypad to enter the desired temperature and press "SET" or "ENTER."
 - The temperature must be within the range of 120°to 190°F.
 - Display alternates between cook mode and probe temperature.
 - Probe temperature displays "LO" until 100°F is reached, then displays actual temperature.
 6. When the probe is within 10°F of setpoint, two long beeps will sound. When the setpoint is reached, three long beeps will sound and the oven will turn off. The display will alternate between cook mode and "DONE." One short beep will sound every minute until the probe function is closed.
 7. Press any key to close the probe function.

Using the Oven

Rack Positions

Each oven is equipped with two standard tilt-proof racks and one TruGlide™ rack. With the TruGlide™ rack, the bottom section remains in the oven and the top section smoothly glides outward when pulled. This reduces the chances of spills from items that contain a lot of juice or liquid. This rack can be used in any of the five rack positions.

All ovens have five rack positions. Position 5 is the farthest from the oven bottom. Position 1 is the closest to the oven bottom. The racks can be easily removed and arranged at various levels. For best results with conventional baking, do not use more than one rack at a time. It is also recommended, when using two racks, to bake with the racks in positions 2 and 4 or positions 3 and 5.

1. Arrange the oven racks in the desired positions BEFORE heating the oven. If cooking on two racks at the same time, use rack positions 2 and 4 or positions 3 and 5.
2. Turn the Oven Function selector to desired function. Cooking starts immediately and stops when the Oven Function selector is turned to "OFF".
3. Set the Temperature Control to the desired temperature.
4. Place the food in the oven after the oven indicator light goes out.

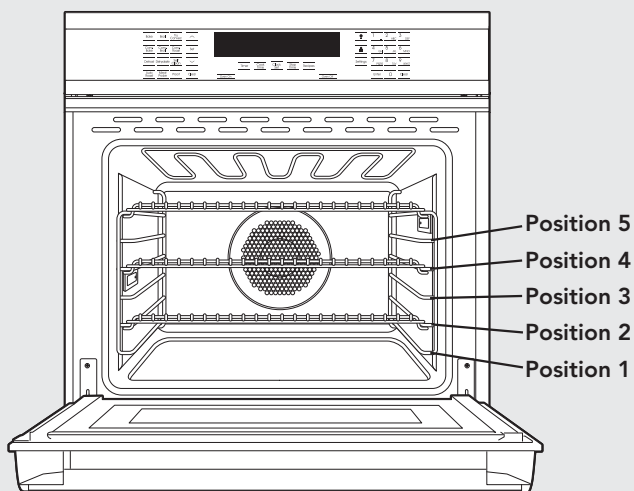

Using the Oven

Conventional and Convection Cooking

Because of variations in food density, surface texture and consistency, some foods may be prepared more successfully using the conventional bake setting. For this reason, conventional baking is recommended when preparing baked goods such as custard. The user may find other foods that are also prepared more consistently in conventional bake. This is perfectly normal. Convection cooking is a cooking technique which utilizes fan forced air to circulate heat throughout the entire oven creating the optimum cooking environment. Cooking with convection is intended when performing multi-rack baking and for baking heavier foods. Below are tips which will allow you to get the best results out of your oven when cooking with convection.

- As a general rule, to convert conventional recipes to convection recipes, reduce the temperature by 25°F (-3.9°C) and the cooking time by approximately 10 to 15%.
- Cooking times for standard baking and convection baking will be the same. However, if using convection to cook a single item or smaller load, then it is possible to have 10-15% reduction in cooking time. (Remember convection cooking is designed for multi-rack baking or cooking large loads.)
- If cooking items which require longer than 45 minutes, then it is possible to see a 10-15% reduction in cooking time. This is especially true for large items cooked in the convection roast function.
- A major benefit of convection cooking is the ability to prepare foods in quantity. The uniform air circulation makes this possible. Foods that can be prepared on two of three racks at the same time include: pizza, cakes, cookies, biscuits, muffins, rolls, and frozen convenience foods.
- For three-rack baking, use any combination of rack positions 2, 3, 4, and 5. For two-rack baking, use rack positions 2 and 4 or positions 3 and 5. Remember that the racks are numbered from bottom to top. See "Oven Features" illustration.
- Items cooked in a convection function can be easily over-baked. This being the case, it is usually a good idea to pull items out of the oven just before they seem to be done. Items will continue to cook right after they are set out of the oven.
- Some recipes, especially those that are homemade, may require adjustment and testing when converting from standard to convection modes. If unsure how to convert a recipe, begin by preparing the recipe in conventional bake. After achieving acceptable results, follow the convection guidelines listed for the similar food type. If the food is not prepared to your satisfaction during this first convection trial, adjust only one recipe variable at a time (cooking time, rack position, or temperature) and repeat the convection test. Continue adjusting one recipe variable at a time until satisfactory results are achieved.

Using the Oven

Condensation

The oven is supplied with a system which provides a natural circulation of air. In most cases, this natural circulation will eliminate any observed condensation. However, there will be instances where condensation is observed. This is NOT a sign that the oven is not working properly.

Condensation can occur depending on the following factors:

- Type of food being cooked
 - Steam and condensation is a natural by product of cooking any food with high water content, such as frozen food, chicken, etc.
 - Use a covered container, where practical, when cooking to reduce the amount of condensation that forms.
- Length of cooking time
 - If the oven is going to be used for prolonged periods of time, then additional ventilation may be required.
 - Do not leave food in the oven to cool after it has been cooked and the oven has been switched off.
 - To reduce condensation, ensure the oven is well heated before placing food in the oven cavity.
- Blockage of the oven's air flow
 - If the oven air flow is changed, the oven will not perform to specification.
- Proper installation ventilation
 - The oven needs good ventilation within the installed cabinets to perform per specification.
- Type of cabinetry the oven is installed in
 - Cabinets need to meet specific temperature requirements.
 - Some cabinetry materials have high water contents that can outgas during the heating cycle.
- Ambient conditions in the kitchen including humidity and temperature

Using the Oven

Pan Placement Tips

- When using large (15" x 13") flat pans or trays that cover most of the rack, rack positions 2 or 3 produce the best results.
- When baking on more than one rack, it is recommended to use one of the convection modes and the 2nd and 4th position or the 3rd and 5th position for more even baking. When baking on three racks, use any combination of positions 2, 3, 4, and 5 for more consistent results.
- Stagger pans in opposite directions when two racks and several pans are used in conventional bake. If possible, no pan should be directly above another.
- Allow 1 to 2 inches of air space around all sides of each pan for even air circulation.

Single Rack Pan Placement

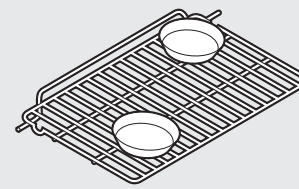

Multiple Rack Pan Placement

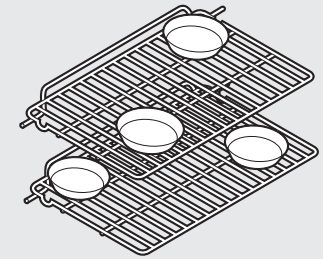

Baking

Bake	Broil	Tru Convec	^
Conv. Bake	Conv. Broil	Conv. Roast	Set
Defrost	Dehydrate	Self Clean	v
Auto Roast	Meat Probe	Proof	Clear

BAKE (Two-Element Bake)

Full power heat is radiated from the bake element in the bottom of the oven cavity and supplemental heat is radiated from the broil element. This function is recommended for single-rack baking. Many cookbooks contain recipes to be cooked in the conventional manner.

Conventional baking/roasting is

particularly suitable for dishes that require a high temperature. Use this setting for baking, roasting, and casseroles.

Bake	Broil	Tru Convec	^
Conv. Bake	Conv. Broil	Conv. Roast	Set
Defrost	Dehydrate	Self Clean	v
Auto Roast	Meat Probe	Proof	Clear

CONV BAKE (Convection Bake)

The bottom element operates at full power, and the top broil element operates at supplemental power. The heated air is circulated by the motorized fan in the rear of the oven providing a more even heat distribution. This even circulation of air equalizes the temperature throughout the oven cavity

and eliminates the hot and cold spots found in conventional ovens. A major benefit of convection baking is the ability to prepare food in quantity using multiple racks—a feature not possible in a standard oven.

When roasting using this setting, cool air is quickly replaced, searing meats on the outside and retaining more juices and natural flavor on the inside with less shrinkage. With this heating method, foods can be baked and roasted at the same time with minimal taste transfer, even when different dishes are involved, such as cakes, fish or meat. The hot air system is especially economical when thawing frozen food. Use this setting for baking and roasting.

Baking

TRU CONV (TruConvec™)

The rear element only operates at full power. There is no direct heat from the bottom or top elements. The motorized fan in the rear of the oven circulates air in the oven cavity for even heating. Use this setting for foods that require gentle cooking such as pastries, souffles, yeast breads, quick breads and cakes. Breads, cookies, and other baked goods come out evenly textured with golden crusts. No special bakeware is required. Use this function for single-rack baking, multiple-rack baking, roasting, and preparation of complete meals. This setting is also recommended when baking large quantities of baked goods at one time.

Bake	Broil	Tru Convec	^
Conv. Bake	Conv. Broil	Conv. Roast	Set
Defrost	Dehydrate	Self Clean	v
Auto Roast	Meat Probe	Proof	Clear

Baking Tips

- Make sure the oven racks are in the desired positions before you turn the oven on.
- **DO NOT** open the oven door frequently during baking. If you must open the door, the best time is during the last quarter of the baking time.
- Bake to shortest time suggested and check for doneness before adding more time. For baked goods, a stainless steel knife placed in the center of the food should come clean when done.
- Use the pan size and type recommended by the recipe to ensure best results. Cakes, quick breads, muffins, and cookies should be baked in shiny, reflective pans for light, golden crusts. Avoid the use of old, darkened pans. Warped, dented, stainless steel and tin-coated pans heat unevenly and will not give uniform baking results.

Baking

Bake Instructions

This function is recommended for single-rack baking. Use this setting for baking, roasting, and casseroles.

To use Bake:

1. Arrange the oven racks in the desired positions before heating the oven.
2. Select "UPPER OVEN" or "LOWER OVEN."
3. Set the Oven Function Selector to "BAKE." Temperature display flashes a preset temperature of 350°F.
4. Set the temperature using one of the following two methods:
 - a. Confirm preset temperature and press "SET" or "ENTER."
The oven will begin Bake Preheat immediately.

OR

- b. Change the temperature by typing the desired temperature on the numeric keypad or using the up and down arrow keys. Press "SET" or "ENTER" when finished. The oven will begin Bake Preheat immediately.

During Bake Preheat

The display will alternate between showing the set baking temperature and the actual preheat temperature every 5 seconds. When the set baking temperature is reached, one long beep will sound and the display will show "BAKE." Open oven door and put food in the oven.

To change set temperature during preheat stage:

	Press and Release
▲	Temperature increases by 5°F (2°C)
▼	Temperature decreases by 5°F (2°C)

Oven Off

The oven will continue operating until you press the "OFF" button for the oven you are using. To turn the oven off, press the "OFF" button on the control panel display. One beep will sound and the oven will turn off.

Baking

Convection Bake Instructions

This function is recommended for multi-rack baking. Foods can be baked and roasted at the same time with minimal taste transfer, even when different dishes are involved, such as cakes, fish, or meat.

To use Convection Bake:

1. Arrange the oven racks in the desired positions before heating the oven.
2. Select "UPPER OVEN" or "LOWER OVEN."
3. Set the Oven Function Selector to "CONV. BAKE." Temperature display flashes a preset temperature of 325°F.
4. Set the temperature using one of the following two methods:
 - a. Confirm preset temperature and press "SET" or "ENTER."
The oven will begin Convection Bake Preheat immediately.

OR

- b. Change the temperature by typing the desired temperature on the numeric keypad or using the up and down arrow keys. Press "SET" or "ENTER" when finished. The oven will begin Convection Bake Preheat immediately.

During Convection Bake Preheat

The display will alternate between showing the set baking temperature and the actual preheat temperature every 5 seconds. When the set baking temperature is reached, one long beep will sound and the display will show "CONV. BAKE." Open oven door and put food in oven.

To change set temperature during preheat stage:

	Press and Release
▲	Temperature increases by 5°F (2°C)
▼	Temperature decreases by 5°F (2°C)

Oven Off

The oven will continue operating until you press the "OFF" button for the oven you are using. To turn the oven off, press the "OFF" button on the control panel display. One beep will sound and the oven will turn off.

Baking

TruConvect™ Instructions

This function is ideal for foods that require gentle cooking, single-rack baking, multiple-rack baking, roasting, and preparation of complete meals. This setting is also recommended when preparing large quantities of baked goods at one time.

To use TruConvect™:

1. Arrange the oven racks in the desired positions before heating the oven.
 2. Select "UPPER OVEN" or "LOWER OVEN."
 3. Set the Oven Function Selector to "TRUCONVEC."
Temperature display flashes a preset temperature of 325°F.
 4. Set the temperature using one of the following two methods:
 - a. Confirm preset temperature and press "SET" or "ENTER." The oven will begin TruConvect™ Preheat immediately.
- OR**
- b. Change the temperature by typing the desired temperature on the numeric keypad or using the up and down arrow keys. Press "SET" or "ENTER" when finished. The oven will begin TruConvect™ Preheat immediately.

During TruConvect™ Preheat

The display will alternate between showing the set baking temperature and the actual preheat temperature every 5 seconds. When the set baking temperature is reached, one long beep will sound and the display will show "TRUCONVEC." Open oven door and put food in oven.

To change set temperature during preheat stage:

	Press and Release
▲	Temperature increases by 5°F (2°C)
▼	Temperature decreases by 5°F (2°C)

Oven Off

The oven will continue operating until you press the "OFF" button for the oven you are using. To turn the oven off, press the "OFF" button on the control panel display. One beep will sound and the oven will turn off.

Baking

Baking Chart

Food	Pan Size	Single Rack Position	Temp	Time (min)
BREADS				
Biscuits	Cookie sheet	3 or 4	400° F (204.4° C)	8 - 10
Yeast loaf	Loaf pan	3 or 4	375° F (190.6° C)	30 - 35
Yeast rolls	Cookie sheet	3 or 4	400° F (204.4° C)	12 - 15
Nut bread	Loaf pan	3 or 4	375° F (190.6° C)	30 - 35
Cornbread	8" x 8"	3 or 4	400° F (204.4° C)	20 - 25
Gingerbread	8" x 8"	3 or 4	350° F (176.7° C)	35 - 40
Muffins	Muffin tin	3 or 4	375° F (190.6° C)	15 - 20
Corn muffins	Muffin tin	3 or 4	375° F (190.6° C)	15 - 20
CAKES				
Angel food	Tube pan	3 or 4	375° F (190.6° C)	35 - 45
Bundt	Tube pan	3 or 4	350° F (176.7° C)	45 - 55
Cupcakes	Muffin pan	3 or 4	350° F (176.7° C)	16 - 20
Layer, sheet	13" x 9"	3 or 4	350° F (176.7° C)	40 - 50
Layer, two	9" round	3 or 4	350° F (176.7° C)	30 - 35
Pound	Loaf pan	3 or 4	350° F (176.7° C)	60 - 65
COOKIES				
Brownies	13" x 9"	3 or 4	350° F (176.7° C)	25 - 30
Choc. chip	Cookie sheet	3 or 4	375° F (190.6° C)	12 - 15
Sugar	Cookie sheet	3 or 4	350° F (176.7° C)	10 - 12
PASTRY				
Cream puffs	Cookie sheet	3 or 4	400° F (204.4° C)	30 - 35
PIES				
Crust, unfilled	9" round	3 or 4	425° F (218.3° C)	10 - 12
Crust, filled	9" round	3 or 4	375° F (190.6° C)	55 - 60
Lemon meringue	9" round	3 or 4	350° F (176.7° C)	12 - 15
Pumpkin	9" round	3 or 4	350° F (176.7° C)	40 - 45
Custard	6 - 4 oz cups	3 or 4	350° F (176.7° C)	35 - 40
ENTREES				
Egg rolls	Cookie sheet	3 or 4	400° F (204.4° C)	12 - 15
Fish sticks	Cookie sheet	3 or 4	425° F (218.3° C)	18 - 21
Lasagna, frz	Cookie sheet	3 or 4	375° F (190.6° C)	65 - 70
Pot pie	Cookie sheet	3 or 4	400° F (204.4° C)	35 - 40
Gr. peppers stuffed	13" x 9"	3 or 4	375° F (190.6° C)	65 - 70
Quiche	9" round	3 or 4	400° F (204.4° C)	25 - 30
Pizza, 12"	Cookie sheet	3 or 4	400° F (204.4° C)	15 - 20
Mac. & cheese, frz	Cookie sheet	3 or 4	375° F (190.6° C)	60 - 65
VEGETABLES				
Baked potatoes	On rack	3 or 4	375° F (190.6° C)	60 - 65
Spinach souffle	1 qt. casserole	3 or 4	350° F (176.7° C)	45 - 50
Squash	Cookie sheet	3 or 4	375° F (190.6° C)	50 - 55
French fries	Cookie sheet	3 or 4	425° F (218.3° C)	15 - 20

Baking

Convection Baking Chart

Food	Pan Size	Single Rack Position	Temp	Time (min)
BREADS				
Biscuits	Cookie sheet	2 & 4	375° F (190.6° C)	7 - 9
Yeast loaf	Loaf pan	2 & 4	350° F (176.7° C)	20 - 25
Yeast rolls	Cookie sheet	2 & 4	375° F (190.6° C)	11 - 13
Nut bread	Loaf pan	2 & 4	350° F (176.7° C)	20 - 25
Cornbread	8" x 8"	2 & 4	375° F (190.6° C)	15 - 20
Gingerbread	8" x 8"	2 & 4	325° F (162.8° C)	30 - 35
Muffins	Muffin tin	2 & 4	350° F (176.7° C)	12 - 15
Corn muffins	Muffin tin	2 & 4	350° F (176.7° C)	0 - 12
CAKES				
Angel food	Tube pan	3 or 4	325° F (162.8° C)	30 - 35
Bundt	Tube pan	3 or 4	325° F (162.8° C)	35 - 40
Cupcakes	Muffin pan	2 & 4	325° F (162.8° C)	15 - 17
Layer, sheet	13" x 9"	2 & 4	325° F (162.8° C)	30 - 32
Layer, two	9" round	2 & 4	325° F (162.8° C)	25 - 30
Pound	Loaf pan	2 & 4	325° F (162.8° C)	5 - 50
COOKIES				
Brownies	13" x 9"	2 & 4	325° F (162.8° C)	20 - 25
Choc. chip	Cookie sheet	2,3,& 4	350° F (176.7° C)	7 - 10
Sugar	Cookie sheet	2,3,& 4	325° F (162.8° C)	9-10
PASTRY				
Cream puffs	Cookie sheet	2 & 4	375° F (190.6° C)	4 - 27
PIES				
Crust, unfilled	9" round	2 & 4	400° F (204.4° C)	7 - 9
Crust, filled	9" round	2 & 4	350° F (176.7° C)	50 - 55
Lemon meringue	9" round	2 & 4	325° F (162.8° C)	4 - 5
Pumpkin	9" round	2 & 4	325° F (162.8° C)	35 - 45
Custard	6 - 4oz cups	2 & 4	325° F (162.8° C)	30 - 35
ENTREES				
Egg rolls	Cookie sheet	2 & 4	375° F (190.6° C)	8 - 10
Fish sticks	Cookie sheet	2 & 4	400° F (204.4° C)	13 - 16
Lasagna, frz	Cookie sheet	2 & 4	350° F (176.7° C)	60 - 65
Pot pie	Cookie sheet	2 & 4	375° F (190.6° C)	10 - 12
Gr. peppers stuffed	13" x 9"	2 & 4	350° F (176.7° C)	45 - 50
Quiche	9" round	2 & 4	375° F (190.6° C)	20 - 25
Pizza, 12"	Cookie sheet	2 & 4	375° F (190.6° C)	10 - 12
Mac. & cheese, frz	Cookie sheet	3 or 4	350° F (176.7° C)	45 - 50
VEGETABLES				
Baked potatoes	On rack	3 or 4	350° F (176.7° C)	45 - 50
Spinach soufflé	1 qt. casserole	3 or 4	325° F (162.8° C)	35 - 40
Squash	Cookie sheet	3 or 4	350° F (176.7° C)	40 - 45
French fries	Cookie sheet	3 or 4	400° F (204.4° C)	10 - 15

Solving Baking Problems

Baking problems can occur for many reasons. Check the chart below for the causes and remedies for the most common problems. It is important to remember that the temperature setting and cooking times you are accustomed to using with your previous oven may vary slightly from those required with this oven. If you find this to be true, it is necessary for you to adjust your recipes and cooking times accordingly.

Common Baking Problems/Remedies

Problems	Cause	Remedy
Cakes burned on the sides or not done in center	<ol style="list-style-type: none"> 1. Oven was too hot 2. Wrong pan size 3. Too many pans 	<ol style="list-style-type: none"> 1. Reduce temperature 2. Use recom. pan size 3. Reduce no. of pans
Cakes crack on top	<ol style="list-style-type: none"> 1. Batter too thick 2. Oven too hot 3. Wrong pan size 	<ol style="list-style-type: none"> 1. Follow recipe 2. Add liquid 3. Reduce temperature 4. Use recom. pan size
Cakes are not level	<ol style="list-style-type: none"> 1. Batter uneven 2. Oven or rack not level 3. Pan was warped 	<ol style="list-style-type: none"> 1. Distribute batter even 2. Level oven or rack 3. Use proper pan
Food too brown on bottom	<ol style="list-style-type: none"> 1. Oven door opened too often 2. Dark pans being used 3. Incorrect rack position 4. Wrong bake setting 5. Pan too large 	<ol style="list-style-type: none"> 1. Use door window to check food 2. Use shiny pans 3. Use recom. rack position 4. Adjust to conventional or convection setting as needed 5. Use proper pan
Food too brown on top	<ol style="list-style-type: none"> 1. Rack position too high 2. Oven not preheated 3. Sides of pan too high 	<ol style="list-style-type: none"> 1. Use recom. rack position 2. Allow oven to preheat 3. Use proper pans
Cookies too flat	<ol style="list-style-type: none"> 1. Hot cookie sheet 	<ol style="list-style-type: none"> 1. Allow sheet to cool between batches
Pies burned around edges	<ol style="list-style-type: none"> 1. Oven too hot 2. Too many pans used 3. Oven not preheated 	<ol style="list-style-type: none"> 1. Reduce temperature 2. Reduce no. of pans 3. Allow oven to preheat
Pies too light on top	<ol style="list-style-type: none"> 1. Oven not hot enough 2. Too many pans used 3. Oven not preheated 	<ol style="list-style-type: none"> 1. Increase temperature 2. Reduce no. of pans 3. Allow oven to preheat

Roasting

Bake	Broil	Tru Convec	^
Conv. Bake	Conv. Broil	Conv. Roast	Set
Defrost	Dehydrate	Self Clean	v
Auto Roast	Meat Probe	Proof	Clear

CONV ROAST (Convection Roast)

The convection element runs in conjunction with the inner and outer broil elements. This transfer of heat (mainly from the convection element) seals moisture inside large roasts. Use this setting for whole turkeys, whole chickens, hams, etc.

Note: You can also roast foods using bake settings. See the "Baking" section for additional information.

Roasting Tips

ALWAYS use the broiler pan and grid supplied with each oven. The hot air must be allowed to circulate around the item being roasted. **DO NOT** cover what is being roasted. Convection roasting seals in juices quickly for a moist, tender product. Poultry will have a light, crispy skin and meats will be browned, not dry or burned. Cook meats and poultry directly from the refrigerator. There is no need for meat or poultry to stand at room temperature.

- As a general rule, to convert conventional recipes to convection recipes, reduce the temperature by 25°F (-3.9°C) and the cooking time by approximately 10 to 15%.
- **ALWAYS** roast meats fat side up in a shallow pan using a roasting rack. No basting is required when the fat side is up. **DO NOT** add water to the pan as this will cause a steamed effect. Roasting is a dry heat process.
- Poultry should be placed breast side up on a rack in a shallow pan. Brush poultry with melted butter, margarine, or oil before and during roasting.
- For convection roasting, **DO NOT** use pans with tall sides as this will interfere with the circulation of heated air over the food.
- If using a cooking bag, foil tent, or other cover, use the conventional bake setting rather than either convection setting.

Roasting

Roasting Tips (cont.)

- When using a meat thermometer, insert the probe halfway into the center of the thickest portion of the meat. (For poultry, insert the thermometer probe between the body and leg into the thickest part of the inner thigh.) The tip of the probe should not touch bone, fat, or gristle to ensure an accurate reading. Check the meat temperature halfway through the recommended roasting time. After reading the thermometer once, insert it 1/2 inch (1.3 cm) further into the meat, then take a second reading. If the second temperature registers below the first, continue cooking the meat.
- Roasting times **ALWAYS** vary according to the size, shape and quality of meats and poultry. Less tender cuts of meat are best prepared in the conventional bake setting and may require moist cooking techniques. Remove roasted meats from the oven when the thermometer registers 5°F (-15°C) to 10°F (-12°C) lower than the desired doneness. The meat will continue to cook after removal from the oven. Allow roasts to stand 15 to 20 minutes after roasting in order to make carving easier.

For many foods, especially roasts and poultry, internal food temperature is the best test for doneness. The meat probe takes the guesswork out of roasting by cooking foods to the exact doneness you want.

Note: Double oven models have a probe in the upper oven only.

Use of probes other than the one provided with this product may result in damage to the probe. Use the handles of the probe and plug when inserting and removing them from the meat and outlet.

- To avoid damaging your probe, **DO NOT** use tongs to pull on the cable when removing.
- To avoid breaking the probe, make sure food is completely defrosted before inserting.
- To prevent possible burns, **DO NOT** unplug the probe from the outlet until the oven has cooled.
- **NEVER** leave the probe inside the oven during a self-cleaning cycle.
- **DO NOT** store the probe in the oven.

Roasting

Roasting Tips (cont.)

After preparing the meat and placing on broiler pan, follow these steps for proper probe placement.

- Lay the probe on the outside of the meat along the top or side and mark with your finger where the edge of the meat comes to on the probe. The point should rest in the center of the thickest meaty part of the roast.
- Insert the probe completely into the meat. It should not touch the bone, fat, or gristle. For roasts with no bone, insert the probe into the meatiest part of the roast. For bone-in ham or lamb, insert the probe into the center of the lowest large muscle or joint. Insert the probe into the meatiest part of the inner thigh from below and parallel to the leg of a whole turkey.
- When setting the probe temperature, it is recommended to set the temperature about 10°F (4°C) lower than desired internal temperature. The meat will continue to cook when removed from the oven and will reach the desired doneness while “standing”.

Roasting

Convection Roast Instructions

Use this function when roasting tender cuts of meat or poultry of any size.

To use Convection Roast:

1. Arrange the oven racks in the desired positions before heating the oven.
2. Select “UPPER OVEN” or “LOWER OVEN.”
3. Set the Oven Function Selector to “CONV. ROAST.” Temperature display flashes a preset temperature of 325°F.
4. Set the temperature using one of the following two methods:
 - a. Confirm preset temperature and press “SET” or “ENTER.” The oven will begin Convection Roast Preheat immediately.

OR

- b. Change the temperature by typing the desired temperature on the numeric keypad or using the up and down arrow keys. Press “SET” or “ENTER” when finished. The oven will begin Convection Roast Preheat immediately.

During Convection Roast Preheat

The display will alternate between showing the set temperature and the actual preheat temperature every 5 seconds. When the set temperature is reached, one long beep will sound and the display will show “CONV. ROAST.” Open oven door and put food in oven.

To change set temperature during preheat stage:

	Press and Release
▲	Temperature increases by 5°F (2°C)
▼	Temperature decreases by 5°F (2°C)

Oven Off

The oven will continue operating until you press the “OFF” button for the oven you are using. To turn the oven off, press the “OFF” button on the control panel display. One beep will sound and the oven will turn off.

Roasting

Bake	Broil	Tru Convec	^
Conv. Bake	Conv. Broil	Conv. Roast	Set
Defrost	Dehydrate	Self Clean	v
Auto Roast	Meat Probe	Proof	Clear

Auto Roast Instructions

Use this function further simplifies roasting by automatically searing the outside of meats, raising the pre-set temperature by 100°F for a short time to sear the outside of the meat. The temperature then returns to the pre-set temperature in the standard convection roast mode.

To use Auto Roast:

1. Arrange the oven racks in the desired positions before heating the oven.
2. Select "UPPER OVEN" or "LOWER OVEN."
3. Set the Oven Function Selector to "AUTO ROAST." Temperature display flashes a preset temperature of 325°F.
4. Set the temperature using one of the following two methods:
 - a. Confirm preset temperature, press "SET" or "ENTER." The oven will begin TruConvec™ Preheat immediately.

OR

- b. Change the temperature by typing the desired temperature on the numeric keypad or using the up and down arrow keys. Press "SET" or "ENTER" when finished. The oven will begin TruConvec™ Preheat immediately.

During Auto Roast Preheat

The display will alternate between showing the set roasting temperature and the actual preheat temperature every 5 seconds.

When Set Auto Roast Temperature Is Reached

One long beep will sound and the display will show "SEARING." The oven will remain at searing temperature (set temperature plus 100°F) for 30 minutes. If set, the Cook Time timer will begin.

Oven Off

The oven will continue operating until you press the "OFF" button for the oven you are using. To turn the oven off, press the "OFF" button on the control panel display. One beep will sound and the oven will turn off.

Roasting

Conventional Roasting Chart
(when using the Bake or Convection Bake setting)

Food	Weight	Temp	Time (min/lb)	Internal Temp
BEEF				
Rib roast				
Rare	4 - 6 lbs	325° F (162.8° C)	25	140° F (60.0° C)
Medium	4 - 6 lbs	325° F (162.8° C)	30	155° F (68.3° C)
Well done	4 - 6 lbs	325° F (162.8° C)	40	170° F (76.7° C)
Rump roast				
Medium	4 - 6 lbs	325° F (162.8° C)	25	155° F (68.3° C)
Well done	4 - 6 lbs	325° F (162.8° C)	30	170° F (76.7° C)
Tip roast				
Medium	3 - 4 lbs	325° F (162.8° C)	35	155° F (68.3° C)
Well done	3 - 4 lbs	325° F (162.8° C)	40	170° F (76.7° C)
LAMB				
Lamb leg	3 - 5 lbs	325° F (162.8° C)	30	180° F (82.2° C)
PORK				
Pork loin	3 - 5 lbs	325° F (162.8° C)	35	180° F (82.2° C)
Pork chops 1" thick	1 - 1 1/4 lbs	350° F (176.7° C)	55 - 60 total time	N/A
Ham, fully cooked	5 lbs	325° F (162.8° C)	18	130° F (54.4° C)
POULTRY				
Chicken, whole	3 - 4 lbs	375° F (190.6° C)	30	180° F (82.2° C)
Turkey, unstuffed	12 - 16 lbs	325° F (162.8° C)	16 - 20	180° F (82.2° C)
Turkey	20 - 24 lbs	325° F (162.8° C)	16 - 20	180° F (82.2° C)
Turkey, stuffed	12 - 16 lbs	325° F (162.8° C)	17 - 21	180° F (82.2° C)
Turkey, stuffed	20 - 24 lbs	325° F (162.8° C)	17 - 21	180° F (82.2° C)
Turkey breast	4 - 6 lbs	325° F (162.8° C)	20	180° F (82.2° C)

Note: The above information is given as a guide only.

Roasting

Convection Roasting Chart

Food	Weight	Temp	Time (min/lb)	Internal Temp
BEEF				
Rib roast				
Rare	4 - 6 lbs	325° F (162.8° C)	25	140° F (60.0° C)
Medium	4 - 6 lbs	325° F (162.8° C)	24	155° F (68.3° C)
Well done	4 - 6 lbs	325° F (162.8° C)	30	170° F (76.7° C)
Rump roast				
Medium	4 - 6 lbs	325° F (162.8° C)	20	155° F (68.3° C)
Well done	4 - 6 lbs	325° F (162.8° C)	24	170° F (76.7° C)
Tip roast				
Medium	3 - 4 lbs	325° F (162.8° C)	30	155° F (68.3° C)
Well done	3 - 4 lbs	325° F (162.8° C)	35	170° F (76.7° C)
LAMB				
Lamb leg	3 - 5 lbs	325° F (162.8° C)	30	180° F (82.2° C)
PORK				
Pork loin	3 - 5 lbs	325° F (162.8° C)	30	180° F (82.2° C)
Pork chops 1" thick	1 - 1 1/4 lbs	325° F (162.8° C)	45 - 50 total time	N/A
Ham, fully cooked	5 lbs	325° F (162.8° C)	15	130° F (54.4° C)
POULTRY				
Chicken, whole	3-4 lbs	350 (176.7 C)	25	180° F (82.2° C)
Turkey, unstuffed	12 - 16 lbs	325° F (162.8° C)	11	180° F (82.2° C)
Turkey	20 - 24 lbs	325° F (162.8° C)	11	180° F (82.2° C)
Turkey, stuffed	12 - 16 lbs	325° F (162.8° C)	9 - 10	180° F (82.2° C)
Turkey, stuffed	20 - 24 lbs	325° F (162.8° C)	9 - 10	180° F (82.2° C)
Turkey breast	4 - 6 lbs	325° F (162.8° C)	20	180° F (82.2° C)

Note: The above information is given as a guide only.

Broiling

CONV BROIL (Convection Broil)

The top element operates at full power. This function is exactly the same as regular broiling with the additional benefit of air circulation by the motorized fan in the rear of the oven. Smoke is reduced since the airflow also reduces peak temperatures on the food. Use this setting for broiling thick cuts of meats.

Bake	Broil	Tru Convec	⤴
Conv. Bake	Conv. Broil	Conv. Roast	Set
Defrost	Dehydrate	Self Clean	⤵
Auto Roast	Meat Probe	Proof	Clear

HI BROIL

Heat radiates from both broil elements, located in the top of the oven cavity, at full power. The distance between the foods and the broil elements determines broiling speed. For fast broiling, food may be as close as 2" (5 cm) to the broil element or on the top rack. Fast broiling is best for meats where rare to medium doneness is desired. Use this setting for broiling small and average cuts of meat.

MED BROIL

Inner and outer broil elements pulse on and off to produce less heat for slow broiling. Allow about 4" (10 cm) between the top surface of the food and the broil element. Slow broiling is best for chicken and ham in order to broil food without over-browning it. Use this setting for broiling small and average cuts of meat.

LOW BROIL

This mode uses only a fraction of the available power to the inner broil element for delicate top-browning. The inner broil element is on for only part of the time. Use this setting to gently brown meringue on racks 3 or 4 in 3-4 minutes.

Broiling

Broiling Tips

- **ALWAYS** use a broiler pan and grid for broiling. They are designed to provide drainage of excess liquid and fat away from the cooking surface to help prevent splatter, smoke, and fire.
- To keep meat from curling, slit fatty edge.
- Brush chicken and fish with butter several times as they broil to prevent drying out. To prevent sticking, lightly grease broiler tray.
- Broil on first side for slightly more than half the recommended time, season, and turn. Season second side just before removing.
- **ALWAYS** pull rack out to stop position before turning or removing food.
- Use tongs or a spatula to turn meats. **NEVER** pierce meat with a fork, as this allows the juices to escape.
- Remove the broiler pan from the oven when you remove the food. Drippings will bake onto the pan if it is left in the heated oven after broiling. While pan is hot, place damp paper towel over grid. Drizzle with liquid dishwashing detergent and pour water over grid. This will make cleaning of the pan easier, or the broiler pan can be lined with aluminum foil to make cleaning easier. Be sure the foil extends up the side of the pan. Although it is not recommended, the grid can also be covered with foil. Be sure to slit openings to conform with the openings in the grid so melted fat can drain through to prevent spattering, smoking, or the possibility of grease fire.

Broiling

Broiling Instructions

Broiling is a dry-heat cooking method using direct or radiant heat. It is used for small, individualized cuts such as steaks, chops, and patties. Broiling speed is determined by the distance between the food and the broil element. Choose the rack position based on desired results.

Conventional broiling (LOW, MED or HI BROIL) is most successful for cuts of meat 1-2 inches thick and is also more suitable for flat pieces of meat. Convection broiling has the advantage of broiling food slightly quicker than conventional. Convection broiling of meats produces better results, especially for thick cuts. The meat sears on the outside and retains more juices and natural flavor inside with less shrinkage.

To Use Broil:

1. Arrange the oven rack in the desired position before turning the broiler on.
2. Place the food in the center of the cold broiler pan and grid supplied with your oven, and then place the broiler pan in the oven.
3. Select "UPPER OVEN" or "LOWER OVEN."
4. Set the Oven Function Selector to "BROIL." Display will show "BROIL HIGH" and "ON" will flash. Medium and low displays will show "CONV BROIL M" and "CONV BROIL L."
5. Choose power level for BROIL:
 - a. For "HIGH BROIL," press "SET."
 - b. For "MEDIUM BROIL," press down arrow key once. Display will change to MED, then press "SET."
 - c. For "LOW BROIL," press down arrow key twice. Display will change to "LO," then press "SET."
6. Close the door to the oven. With closed-door broiling, the broil element might cycle on and off if an extended broiling time is required. A built-in smoke "eliminator" in the top of the oven will help reduce smoke and odors.
7. When cooking is complete, press the "OFF" button for the selected oven.

Oven Off

The oven will continue operating until you press the "OFF" button for the oven you are using. To turn the oven off, press the "OFF" button on the control panel display. One beep will sound and the oven will turn off.

Broiling

Convection Broil Instructions

Convection broiling has the advantage of broiling food slightly more quickly than conventional. Convection broiling of meats also produces better results, especially for thick cuts. This is because meat sears on the outside and retains more juices and natural flavor inside with less shrinkage.

To Use Convection Broil:

1. Arrange the oven rack in the desired position before turning the broiler on.
2. Place the food in the center of the cold broiler pan and grid supplied with your oven, and then place the broiler pan in the oven.
3. Select "UPPER OVEN" or "LOWER OVEN."
4. Set the Oven Function Selector to "CONV. BROIL." Display will show "CONV BROIL H" and "ON" will flash. Medium and low displays will show "CONV BROIL M" and "CONV BROIL L."
5. Choose power level for CONVECTION BROIL:
 - a. For "HIGH CONVECTION BROIL," press "SET."
 - b. For "MEDIUM CONVECTION BROIL," press down arrow key once. Display will change to MED, then press "SET."
 - c. For "LOW CONVECTION BROIL," press down arrow key twice.
 - d. Display will change to "LO", then press "SET."
6. Close the door to the oven. With closed-door broiling, the broil element might cycle on and off if an extended broiling time is required. A built-in smoke "eliminator" in the top of the oven will help reduce smoke and odors.
7. When cooking is complete, press the "OFF" button for the selected oven.

Oven Off

The oven will continue operating until you press the "OFF" button for the oven you are using. To turn the oven off, press the "OFF" button on the control panel display. One beep will sound and the oven will turn off.

Broiling

Broiling Chart

Type and Cut of Meat	Weight	Setting	Rack	Time (min)
BEEF				
Sirloin, 1"				
Rare	14 oz	Hi Broil	5 or 6	8-10
Medium	14 oz	Hi Broil	5 or 6	10-12
Well done	14 oz	Hi Broil	5 or 6	11-13
T-Bone, 3/4"				
Rare	10 oz	Hi Broil	5 or 6	7-8
Medium	10 oz	Hi Broil	5 or 6	9-10
Well done	10 oz	Hi Broil	5 or 6	11-12
Hamburger, 1/2"				
Rare	1/4 lb.	Hi Broil	5 or 6	6-7
Medium	1/4 lb.	Hi Broil	5 or 6	7-8
Well done	1/4 lb.	Hi Broil	5 or 6	8-9
CHICKEN				
Bnls breast 1"	1/2 lb.	Med-Broil	5 or 6	15-20
Bnls breast 1"	1/2 lb.	Convection Broil	4 or 5	15-20
Bones in Breast	2 -3 lbs. total	Med Broil	3 or 4	40-45
Bones in Breast	2 -3 lbs. total	Convection Broil	3 or 4	25-30
Chicken pieces	2 -3 lbs. total	Med Broil	3 or 4	40-45
Chicken pieces	2 -3 lbs. total	Convection Broil	3	25-30
HAM				
Ham slice, 1"	1 lb.	Med Broil	5 or 6	22
LAMB				
Rib chops, 1"	12 oz.	Convection Broil	4 or 5	7
Shoulder	1 lb.	Convection Broil	4 or 5	6
PORK				
Loin chops, 3/4"	1 lb.	Convection Broil	4	14
Bacon		Med Broil	5	6
FISH				
Salmon steak	1 lb.	Med Broil	4	7
Fillets	1 lb.	Med Broil	4 or 5	6

Note: The above information is given as a guide only.

Warming Modes

Bake	Broil	Tru Convec	⤴
Conv. Bake	Conv. Broil	Conv. Roast	Set
Defrost	Dehydrate	Self Clean	⤵
Auto Roast	Meat Probe	Proof	Clear

Convection Dehydrate

This oven is designed not only to cook, but also to dehydrate fruits and vegetables. With this function, a motorized fan in the rear of the oven circulates warm air. Over a period of time, the water is removed from the food by evaporation. Removal of water inhibits growth of microorganisms and retards

the activity of enzymes. It is important to remember that dehydration does not improve quality; only fresh, top-quality foods should be dehydrated in your oven.

To use Dehydrate:

1. Prepare the food as recommended.
2. Choose and press "UPPER OVEN" or "LOWER OVEN."
3. Arrange the food on drying racks (not included with the oven, but available from specialty cooking dealers).
4. Select "DEHYDRATE" from the oven function control panel.
5. Press "SET" or "ENTER." Dehydrate mode will begin immediately.

⚠ CAUTION

You must carefully check the food during the dehydration process to ensure that it does not catch fire.

Warming Modes

Bake	Broil	Tru Convec	⤴
Conv. Bake	Conv. Broil	Conv. Roast	Set
Defrost	Dehydrate	Self Clean	⤵
Auto Roast	Meat Probe	Proof	Clear

Convection Defrost

This oven can defrost frozen food. With the temperature control off, a motorized fan in the rear of the oven circulates air. This fan accelerates natural defrosting of the food without heat.

To use Defrost:

1. Place the frozen food on a baking sheet.
2. Choose and press "UPPER OVEN" or "LOWER OVEN."
3. Select "DEFROST" from the oven function control panel.
4. Press "SET" or "ENTER" to begin defrosting. The defrost mode will begin and the defrost temperature will be displayed.

⚠ WARNING

To avoid sickness and food waste, **DO NOT** allow defrosted food to remain in the oven for more than 2 hours.

Proofing

This function uses a low temperature to create an optimal environment for the yeast to rise in many types of dough.

This setting is designed for allowing yeast dough to rise to a temperature between 85°F (29°C) and 100°F (38°C).

Yeast doughs rise or "proof" best when the temperature is between 85°F (29°C) and 100°F (38°C). To make sure the dough is warm enough, cover the bowl loosely with plastic wrap and/or cloth towel.

To use Proof:

1. Place the dough on a baking sheet.
2. Choose and press "UPPER OVEN" or "LOWER OVEN."
3. Select "PROOF" from the oven function control panel.
4. Press "SET" or "ENTER" to begin proofing.

Place the bowl on the center rack of the oven and close door. When you think the dough has doubled in size, lightly poke two fingers about 1/2" (1.3 cm) into the dough. If the indentation remains, the dough has risen enough.

Cleaning and Maintenance

Any piece of equipment works better and lasts longer when maintained properly and kept clean. Cooking equipment is no exception. Your oven must be kept clean and maintained properly.

Oven Surfaces

Several different finishes have been used in your electric oven. Cleaning instructions for each surface are given below and continued on page 40. Your oven features a Self-Clean cycle for the oven interior. See page 41 for complete instructions. **NEVER USE AMMONIA, STEEL WOOL PADS OR ABRASIVE CLOTHS, CLEANSERS, OVEN CLEANERS, OR ABRASIVE POWDERS. THEY CAN PERMANENTLY DAMAGE YOUR OVEN.**

Control Knobs

MAKE SURE ALL THE CONTROL KNOBS POINT TO THE OFF POSITION BEFORE REMOVING. Pull the knobs straight off. Wash in detergent and warm water. Dry completely and replace by pushing firmly onto stem.

Stainless Steel Parts

Some stainless steel parts may have a protective wrap, which must be peeled off. All stainless steel body parts should be wiped regularly with hot, soapy water at the end of each cooling period and with liquid cleaner designed for this material when soapy water will not do the job. If build-up occurs, **DO NOT** use steel wool, or abrasive cloths, cleaners, or powders. If it is necessary to scrape stainless steel surface to remove encrusted material, soak area with hot, wet towels to loosen the material, then use a wooden or nylon spatula or scraper. **DO NOT** use a metal knife, spatula, or any other metal tool to scrape stainless steel surfaces. Scratches are almost impossible to remove.

Cleaning and Maintenance

Broiler Pan and Grid

Clean with detergent and hot water. For stubborn spots, use a soap-filled steel wool pad.

Oven Racks

Clean with detergent and hot water. Stubborn spots can be scoured with a soap-filled steel wool pad. **DO NOT CLEAN THE OVEN RACKS OR RACK SUPPORT USING THE SELF-CLEAN CYCLE.** They could sustain damage due to the extreme heat of the Self-Clean cycle.

Meat Probe

The meat probe may be cleaned with soap and water or a soap-filled scouring pad. Cool the probe before cleaning. Scour stubborn spots with a soap-filled scouring pad, rinse and dry.

- **DO NOT** immerse the meat probe in water.
- **DO NOT** store the probe in the oven.

Self-Clean Cycle

This oven features an automatic pyrolytic self-cleaning cycle. During this cycle, the oven reaches elevated temperatures in order to burn off soil and deposits. An integral smoke eliminator helps reduce odors associated with the soil burn off. A powder ash residue is left in the bottom of the oven after completion of the self-clean cycle. The door latch is automatically activated after selecting the self-clean setting. The latch ensures that the door cannot be opened while the oven interior is at clean temperatures.

Before starting the Self-Clean cycle:

1. Remove the oven racks, and any other items/utensils from the oven. The high heat generated during the cleaning cycle can discolor, warp, and damage these items. **DO NOT** use foil or liners in the oven. During the self-clean cycle, foil can burn or melt and damage the oven surface.
2. Wipe off any large spills from the oven bottom and sides. **NEVER** use oven cleaners inside a self-cleaning oven or on raised portions of the door.
3. Some areas of the oven must be cleaned by hand before the cycle begins. Soils in these areas will be baked on and very difficult to clean if not removed first. Clean the door up to the gasket, the door frame, and up to 2" (5.1 cm) inside the frame with detergent and hot water. Rinse thoroughly and dry.

⚠ WARNING

BURN OR ELECTRICAL SHOCK HAZARD

Make sure all controls are "OFF" and oven is COOL before cleaning. Failure to do so can result in burns or electrical shock.

⚠ CAUTION

DO NOT touch the exterior portions of the oven after self-cleaning cycle has begun, since some parts become extremely hot to the touch! During the first few times the self-cleaning feature is used, there may be some odor and smoking from the curing of the binder in the high-density insulation used in the oven. When the insulation is thoroughly cured, this odor will disappear. During subsequent self-cleaning cycles, you may sense an odor characteristic of high temperatures. Keep the kitchen well-vented during the self-cleaning cycle.

Self-Clean Cycle

To start the Self-Clean cycle:

1. Close the door completely.
2. Select "UPPER OVEN" or "LOWER OVEN." "SELECT MODE" will appear in the display for the selected oven.
3. Press "SELF CLEAN" from the oven function control panel.
4. Press "SET" or "ENTER." At this time, "SELF CLEAN" will appear in the display. The door lock indicator light will remain on until the self-clean is completed or interrupted and the oven temperature drops to a safe temperature. A complete cycle takes approximately 3-1/2 hours, with an additional 30 minutes needed for the oven to cool down enough for the door latch to disengage.

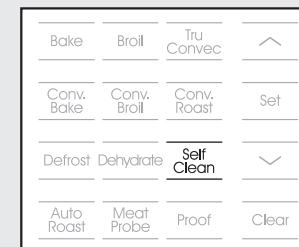

Note: A whirring fan noise will be heard during the self-clean cycle and will continue to run for the 3-1/2 hour duration of the self-clean cycle.

5. The timer will count down from 4 hours. When the cycle is completed, press the "OFF" button for the selected oven.
6. When the oven has completely cooled, open the door and remove any ash from the oven surfaces with a damp cloth.
7. To cancel or interrupt the self-cleaning cycle, press the "OFF" button for the selected oven.

Replacing Oven Lights

⚠ WARNING



ELECTRICAL SHOCK HAZARD

Disconnect the electric power at the main fuse or circuit breaker before replacing bulb.

⚠ WARNING

DO NOT touch bulb with bare hands. Clean off any signs of oil from the bulb and handle with a soft cloth.

Halogen Lights

1. Unsnap glass light cover using a screwdriver in the access groove.
2. Firmly grasp light bulb and pull out.
3. Replace with halogen bulb using volt and wattage requirements listed on glass cover.
4. Replace the light cover by snapping glass cover onto metal box.
5. Reconnect power at the main fuse or circuit breaker.

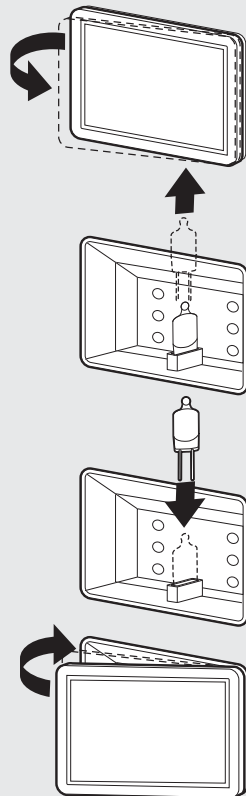

Power Failure

DO NOT attempt to use during a power failure. Unit will not function.

Troubleshooting

Problem	Possible Cause and/or Remedy
Oven will not function.	Oven is not connected to electrical power. Have electrician check power circuit breaker, wiring and fuses..
Oven does not operate in self-clean cycle.	Door is not shut tight enough for automatic door latch to lock.
Door will not open.	Oven is still in self-clean mode. If oven is hot, door latch will release when a safe temperature is reached
Oven light will not work.	Light bulb is burned out. Oven is not connected to power.

Error Handling

In the event that you make an error while programming your Viking oven, you will hear a long beep followed by the appearance of an error message on the display. Use the following key to help you correct these common programming errors:

Error Message	Problem	Correction
MODEL ERROR	An incorrect model number has been installed.	Call your Viking dealer or authorized service agency.
RTD ERROR	RTD is open or shorted.	Call your Viking dealer or authorized service agency.
PROBE ERROR	The meat probe is open or shorted.	The meat probe may not be plugged in. If it isn't, plug it in to the oven. Press the "OFF" key to exit and clear the error message. If the meat probe is plugged in and the Error message is still displayed, call your Viking dealer or authorized service agency.
LATCH ERROR	The control is unable to lock or unlock the door latch.	Call your Viking dealer or authorized service agency.
KEYBOARD ERROR	No connection exists between the keyboard and control.	Call your Viking dealer or authorized service agency.

Service Information

If service is required, call your dealer or authorized service agency. The name of the authorized service agency can be obtained from the dealer or distributor in your area.

Have the following information readily available.

- Model number
- Serial number
- Date purchased
- Name of dealer from whom purchased

Clearly describe the problem that you are having. If you are unable to obtain the name of an authorized service agency, or if you continue to have service problems, contact Viking Range Corporation at 1-888-VIKING1 (845-4641), or write to:

**VIKING RANGE CORPORATION
PREFERRED SERVICE
1803 Hwy 82W
Greenwood, Mississippi 38930 USA**

Record the information indicated below. You will need it if service is ever required. The model and serial number for your oven can be found by using a flashlight to look through one of these vents on the upper vent trim. The label will be on the right side inner wall.

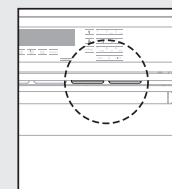

Model no. _____ Serial no. _____

Date of purchase _____ Date installed _____

Dealer's name _____

Address _____

If service requires installation of parts, use only authorized parts to insure protection under the warranty.

Keep this manual for future reference.

Warranty

Notes

BUILT-IN ELECTRIC OVENS WARRANTY

ONE YEAR FULL WARRANTY

Built-in electric ovens and all of their component parts and accessories, except as detailed below*, are warranted to be free from defective materials or workmanship in normal household use for a period of twelve (12) months from the date of original retail purchase. Viking Range Corporation, warrantor, agrees to repair or replace, at its option, any part which fails or is found to be defective during the warranty period.

*Glass (including light bulbs), painted and decorative items are warranted to be free from defective materials or workmanship for a period of ninety (90) days from the date of original retail purchase. ANY DEFECTS MUST BE REPORTED TO THE SELLING DEALER WITHIN NINETY (90) DAYS FROM DATE OF ORIGINAL RETAIL PURCHASE.

Viking Range Corporation uses the most up-to-date processes and best materials available to produce all color finishes. However, slight color variation may be noticed because of the inherent differences in painted parts and porcelain parts as well as differences in kitchen lighting, product locations, and other factors.

FIVE YEAR LIMITED WARRANTY

Any bake element, broil element, or convection cook element which fails due to defective materials or workmanship in normal household use during the second through fifth year from the date of original retail purchase will be repaired or replaced, free of charge for the part itself, with the owner paying all other costs, including labor.

TEN YEAR LIMITED WARRANTY

Any porcelain oven or porcelain inner door panel which rusts through due to defective materials or workmanship in normal household use during the second through the tenth year from the date of original retail purchase will be repaired or replaced, free of charge for the part itself, with the owner paying all other costs, including labor.

NINETY (90) DAY RESIDENTIAL PLUS WARRANTY This warranty applies to applications where use of the product extends beyond normal residential use. Examples are, but not limited to, bed and breakfasts, fire stations, private clubs, churches, etc. This warranty excludes all commercial locations such as restaurants, food service locations and institutional food service locations.

This warranty extends to the original purchaser of the product warranted hereunder and to each transferee owner of the product during the term of the warranty.

This warranty shall apply to products purchased and located in the United States and Canada. Products must be purchased in the country where service is requested. Warranty labor shall be performed by an authorized Viking Range Corporation service agency or representative. Warranty shall not apply to damage resulting from abuse, accident, natural disaster, loss of electrical power to the product for any reason, alteration, outdoor use, improper installation, improper operation, or repair or service of the product by anyone other than an authorized Viking Range Corporation service agency or representative. This warranty does not apply to commercial usage. Warrantor is not responsible for consequential or incidental damage whether arising out of breach of warranty, breach of contract, or otherwise. Some jurisdictions do not allow the exclusion or limitation of incidental or consequential damages, so the above limitation or exclusion may not apply to you.

Owner shall be responsible for proper installation, providing normal care and maintenance, providing proof of purchase upon request, and making the appliance reasonably accessible for service. If the product or one of its component parts contains a defect or malfunction during the warranty period, after a reasonable number of attempts by the warrantor to remedy the defects or malfunctions, the owner is entitled to either a refund or replacement of the product or its component part or parts. Warrantor's liability on any claim of any kind, with respect to the goods or services covered hereunder, shall in no case exceed the price of the goods or service or part thereof which gives rise to the claim.

WARRANTY SERVICE:

Under the terms of this warranty, service must be performed by a factory authorized Viking Range Corporation service agent or representative. Service will be provided during normal business hours, and labor performed at overtime or premium rates shall not be covered by this warranty. To obtain warranty service, contact the dealer from whom the product was purchased, an authorized Viking Range Corporation service agent, or Viking Range Corporation. Provide model and serial number and date of original purchase. For the name of your nearest authorized Viking Range Corporation service agency, call the dealer from whom the product was purchased or Viking Range Corporation. **IMPORTANT:** Retain proof of original purchase to establish warranty period.

The return of the Owner Registration Card is not a condition of warranty coverage. You should, however, return the Owner Registration Card so that Viking Range Corporation can contact you should any question of safety arise which could affect you.

Any implied warranties of merchantability and fitness applicable to the above described bake element, broil element, convection cook element, porcelain oven, or porcelain inner door panel are limited in duration to the period of coverage of the applicable express written limited warranties set forth above. Some jurisdictions do not allow limitations on how long an implied warranty lasts, so the above limitation may not apply to you. This warranty gives you specific legal rights, and you may also have other rights which may vary from jurisdiction to jurisdiction.

Specifications subject to change without notice.