

INSTRUCTION MANUAL

For Built-in Steam and Convection Ovens

Models

MES301HS

MES301HP

Thermador[®]

US

About This Manual	4
Safety	5
Getting Started	8
Your New Appliance	8
Control Panel	8
Touchpads	9
Oven Modes	10
Oven and Accessories	11
Water Tank	13
Automatic Calibration	14
Getting Started	14
Setting the Clock	14
Adjusting the Water Hardness Level	14
Cleaning	15
Operation	16
Operating the Appliance	16
Turning On the Appliance	16
Turning Off the Appliance	17
After Each Use	17
Automatic Shutoff	17
Clock and Timer Settings	18
Setting the Timer	18
Setting the Cook Time	19
Changing the End Time	20
Setting the Clock	21
Automatic Programming - EasyCook	22
Setting a Program	22
Program Information	23
EasyCook - Program Charts	24
Favorites	28
Storing a Setting in Favorites	28
Starting a Favorites Setting	29
Deleting a Favorites Setting	29
Panel Lock	29
Basic Settings	30

Getting the Most Out of Your Appliance	32
Cooking Tables and Tips	32
Steaming	32
True Convection	33
Vegetables	33
Side Dishes and Legumes	34
Meat, poultry, fish	35
Slow Cooking Meat	38
Soufflés, Casseroles, Additions to Soups, etc.	39
Desserts, compote	39
Cakes and Baked Goods	40
Reheating Food	43
Defrosting	44
Proofing Dough	44
Juice Extraction	45
Frozen Products	45
Cleaning and Maintenance	47
Cleaning	47
Cleaners	48
Steam Clean	49
Decalcify	50
Removing and Installing the Appliance Door	51
Cleaning the Rack Rail Frames	53
Cleaning the Door Glass	53
Maintenance	54
Replacing the Oven Bulb	54
Replacing the Door Gasket	55
Service	56
Before Calling Service	56
Customer Service	58
Model and Serial Numbers	58
Energy-Saving Tips	59
STATEMENT OF LIMITED PRODUCT WARRANTY	60
What this Warranty Covers & Who it Applies to	60
How Long the Warranty Lasts	60
Repair/Replace as Your Exclusive Remedy	60
Out of Warranty Product	61
Warranty Exclusions	61

About This Manual

How This Manual is Organized

You can get the most out of your new oven by reading this manual from beginning to end. This way you will systematically get to know your appliance and become familiar with its operation and features.

The manual consists of the following sections:

- The “Safety” section provides information on how to safely operate your oven.
- “Getting Started” introduces you to the oven components and features.
- The “Operation” section offers you step-by-step instructions on how to operate your oven.
- In “Getting the Most Out of Your Appliance” you can find a list of many common foods with the appropriate oven mode, temperature, rack position and bake time. This section also provides you with several bakeware and preparation tips.
- “Cleaning and Maintenance” provides you with information on how to clean and care for the various oven parts.
- The “Service” section includes your warranty and do-it-yourself troubleshooting tips.

Pay special attention to the important safety instructions in the “Safety” section.

Safety



Important Safety Instructions

READ AND SAVE THESE INSTRUCTIONS



WARNING:

When properly cared for, your new oven has been designed to be safe and reliable. Read all instructions carefully before use. These precautions will reduce the risk of burns, electric shock, fire and injury to persons. When using kitchen appliances, basic safety precautions must be followed, including those on the following pages.

Transporting the Appliance

Do not carry or hold the appliance by the door handle. The door handle may break off.

Proper Installation and Maintenance

Have the installer show you the location of the circuit breaker or fuse. Label it for easy reference.

This appliance must be properly installed and grounded by a qualified technician. Connect to a properly grounded outlet only. Refer to the Installation Instructions for details.

This appliance is intended for normal family household use only. It is not approved for outdoor use. Refer to the warranty for more information. If you have any questions, contact the manufacturer.

Do not store or use corrosive chemicals, vapors, flammables or nonfood products in or near this appliance. It is specifically designed for heating or cooking food. Use of corrosive chemicals when heating or cleaning will damage the appliance and could result in injury.

Do not operate this appliance if it is not working properly or if it has been damaged. Contact an authorized service technician.

Do not obstruct oven vents.

Do not repair or replace any part of the appliance unless specifically recommended in this manual. Refer all servicing to a factory authorized service center.

Risk of short circuiting! Never allow electrical appliance cords to become pinched in the hot appliance door. The cord's insulation can melt.

Fire Safety

Do not use aluminum foil or protective liners to line any part of the appliance, especially the oven bottom. Installing these liners may result in risk of electric shock or fire.

If materials inside an oven should ignite, keep door closed. Turn off the appliance, and disconnect the circuit at the circuit breaker box.

Use this appliance only for its intended purpose as described in this manual. For example, never use the appliance for warming or heating the room. Never use the appliance for storage.

Always have a working smoke detector near the kitchen.

In the event that personal clothing or hair catches fire, drop and roll immediately to extinguish flames.

Smother flames from food fires other than grease fires with baking soda. Never use water on cooking fires.

Have an appropriate fire extinguisher available, nearby, highly visible and easily accessible near the oven.

Burn Prevention

DO NOT TOUCH HEATING ELEMENTS OR INTERIOR SURFACES OF OVEN – Heating elements may be hot even if they are dark in color. Interior surfaces of an oven become hot enough to cause burns. During and after use, do not touch, or let clothing, pot holders, or other flammable materials come in contact with heating elements or interior surfaces of the oven until they have had sufficient time to cool. Other surfaces of the appliance may become hot enough to cause burns. These surfaces include oven vent openings, surfaces near these openings and oven doors.

Do not touch hot surfaces. Use handles or knobs.

Exercise caution when opening the appliance. Standing to the side, open the door slowly and only slightly to let hot air and/or steam escape. Keep your face clear of the opening and make sure there are no children or pets near the unit. After the hot air and/or steam is released, proceed with your cooking. Keep doors shut unless necessary for cooking or cleaning purposes. Do not leave open doors unattended.

Do not heat or warm sealed food containers. Build-up of pressure may cause the container to burst and cause injury.

Always place oven racks in desired location while oven is cool. If a rack must be moved while the oven is hot, do not let pot holders touch the heating elements.

Always use dry pot holders. Moist or damp pot holders on hot surfaces may result in burns from steam. Do not let pot holders touch hot heating elements. Do not use a towel or other bulky cloth.

Never prepare food with large quantities of high proof alcoholic beverages. Steam containing alcohol can ignite inside the appliance. Only use small quantities of high proof alcoholic beverages, and use caution when opening the appliance door.

Child Safety

When children become old enough to use the appliance, it is the legal responsibility of the parents or legal guardians to ensure that they are instructed in safe operation of the appliance by qualified persons.

Do not allow anyone to climb, stand, lean, sit, or hang on any part of an appliance, especially a door, warming drawer or storage drawer. This can damage the appliance, and the unit may tip over, potentially causing severe injury.

Do not allow children to use this appliance unless closely supervised by an adult. Children and pets should not be left alone or unattended in the area where the appliance is in use. They should never be allowed to play in its vicinity, whether or not the appliance is in use.

CAUTION – Items of interest to children should not be stored in an appliance, in cabinets above an appliance, or on the backsplash. Children climbing on an appliance to reach items could be seriously injured.

Baking and Steaming Safety

CAUTION – Hot steam can escape during use. Do not touch the ventilation openings.

CAUTION – Hot steam can escape when opening the oven door. Hot water may drip from the door. Keep children away.

CAUTION – Use pot holders to remove inserted cooking accessories from the hot oven. Hot liquid may spill over when removing the cooking accessories.

The oven bottom and the evaporator dish must always remain clear. Always place ovenware on the rack or in the perforated cooking pan.

Ovenware must be heat and steam resistant. Silicone baking pans are not suitable for Combination mode.

When using Steam mode with a perforated cooking pan, always slide the baking pan underneath it. The pan will catch any drippings.

Do not store moist foods for an extended period of time in the closed oven. The food could cause corrosion of the oven interior.

Do not overfill very juicy fruit tarts with fruit when using the baking pan. The fruit juice that drips off the baking pan leaves behind stains that cannot be removed.

When using aluminum foil in the oven, do not allow it to touch the glass on the door. This could cause permanent staining of the door glass.

Do not place anything on the open appliance door. This could damage the appliance.

The use of accessory attachments not recommended by the appliance manufacturer may cause injuries.

Cleaning Safety

Do not clean the appliance while it is still hot. Some cleaners produce noxious fumes when applied to a hot surface. Wet cloths or sponges can cause burns from steam.

Risk of severe burns! Do not clean the appliance immediately after turning it off. The water in the evaporator dish is still hot. Wait until the appliance has cooled down.

The door will no longer close properly if the door gasket is heavily soiled. The face of adjacent furnishings could become damaged. Always keep the door gasket clean and replace it if necessary.

The oven cavity is made of high quality stainless steel. Improper care may result in corrosion of the oven cavity. Follow the care and cleaning instructions provided in the manual. Remove food residue and spills from the cavity immediately after the appliance has cooled down.

Ovenware Safety

Do not place food directly on oven bottom.

Follow the manufacturer's directions when using cooking or roasting bags.

Getting Started

Your New Appliance

This section covers information on the following:

- Control panel
- Oven modes
- Oven and accessories

Control Panel











Touchpads

Sensors are located under the touchpads. The sensors respond to the light touch of your finger on the pad.

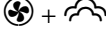
Touchpad	Pad function
ON/OFF	Turns appliance on and off
FAVORITES	Press briefly to select memory Press and hold longer to store in memory
OVEN MODE	Sets the oven mode
PANEL LOCK	Activates/deactivates the panel lock
STEAM CLEAN	Sets Steam Clean mode
EASY COOK	Sets automatic programming
OVEN TEMP	Sets the temperature
TIMER/CLOCK	Sets the time
START/STOP	Press briefly to start/pause operation Press and hold longer to cancel operation
WEIGHT	Sets the weight for EasyCook automatic programming
DECALCIFY	Sets Decalcify mode
INFO	Press briefly to view the current preheating temperature Press and hold longer to open or close the basic settings menu

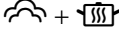
Oven Modes

Use the OVEN MODE touchpad to access the various oven modes of the appliance.

Oven mode	Temperature range	Display symbol	Use
True Convection	85 - 450 °F (30 - 230 °C)		For moist cakes, sponge cakes, braised meat. A fan on the back wall distributes the heat evenly throughout the oven.
Steam	95 - 210 °F (35 - 100 °C)		Vegetables, fish, side dishes; extracting fruit juice.
Combination	250 - 450 °F (120 - 230 °C)		Fish, soufflés and baked goods. Convection and Steam are combined.
Reheat	210 - 360 °F (100 - 180 °C)		Plated dishes and baked goods. Cooked food is gently reheated. The inflow of steam keeps the food moist.
Proof	95 - 120 °F (35 - 50 °C)		Yeast dough and sourdough. The dough rises much faster than at room temperature. Steam and Convection are combined to keep the surface of the dough from drying out.
Defrost	95 - 140 °F (35 - 60 °C)		Fruit, vegetables, meat and fish. Steam and Convection are combined. The humidity in the steamer oven gently transfers heat to the food. The food does not dry out or lose its shape.
Slow Cook	140 - 250 °F (60 - 120 °C)		Roast beef, leg of lamb. Makes all types and cuts of meat extra tender.
Dish Warming	85 - 160 °F (30 - 70 °C)		For ovenware and plates. Food in preheated ovenware does not cool down as quickly. Drinks stay warm longer.
Keep Warm	140 - 210 °F (60 - 100 °C)		Keeps cooked food warm for up to one hour.



CAUTION:

Follow these guidelines when using Keep Warm mode:

- Do not use Keep Warm mode to heat cold food.
- Be sure to maintain proper food temperature. The USDA recommends holding hot food at 140 °F (60 °C) or warmer.
- DO NOT warm food longer than one hour.

Oven and Accessories

The oven has four rack levels. The rack levels are numbered from bottom to top.



WARNING: Do not use aluminum foil or protective liners to line any part of the appliance, especially the cavity bottom. Installing these liners may result in risk of electric shock or fire.



CAUTION: Do not cover the evaporator dish. Do not place ovenware on the cavity bottom.



CAUTION: Do not slide any accessories in between the rack levels. The accessory may tip over.

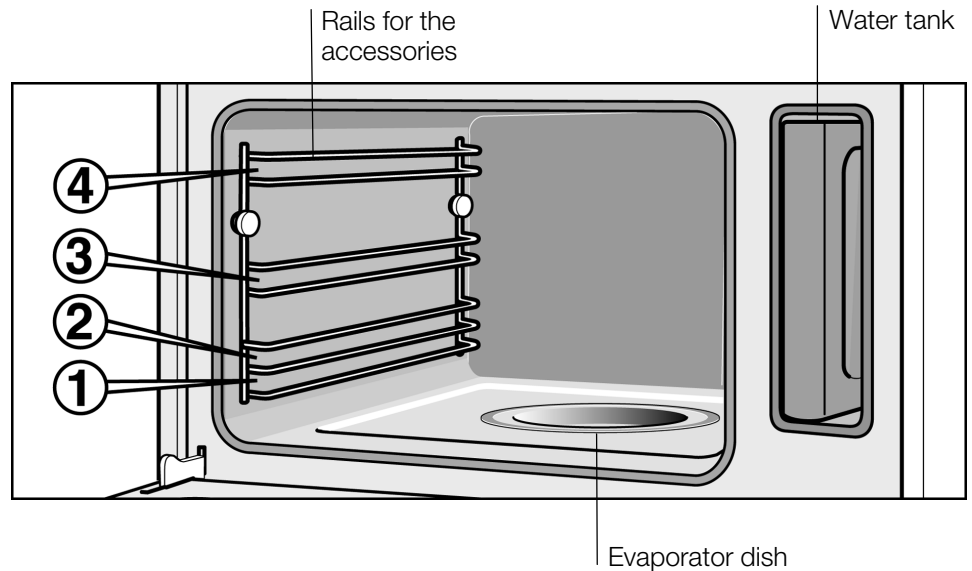

Accessories

Use only accessories that came with the appliance or that were purchased through customer service. The accessories are designed specifically for your appliance.

The following accessories come with the appliance:

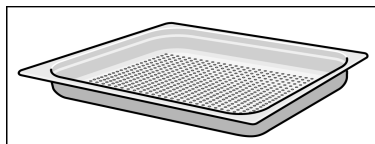

Perforated cooking pan - full size

(CS2XLPH)

1 5/8" deep

Ideal for steaming fish or large quantities of vegetables; for extracting juice from berries and much more.

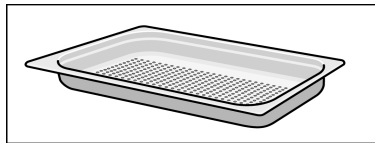

Perforated cooking pan - half size

(CS1XLPH)

1 5/8" deep

Ideal for steaming vegetables, extracting juice from berries, defrosting, and for smaller quantities of food.

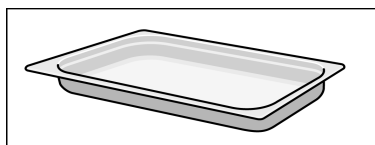

Cooking pan - half size

(CS1XLH)

1 5/8" deep

Use for smaller quantities, rice, and cereals

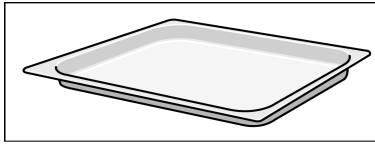

Baking pan - full size

(CS2LH)

1 1/8" deep

Ideal for baking cakes and catching dripping liquids when steaming.

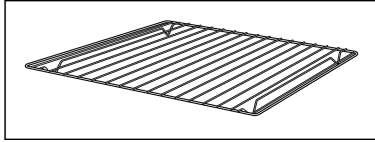

Wire rack

(CSRACKH)

Ideal for baking, cake pans and casseroles.

Also ideal for roasts when used with the full size baking pan.

The following additional accessories can be purchased in retail stores:

Accessory	Order no.
Perforated cooking pan - Full Size, 1 5/8" deep	CS2XLPH
Perforated cooking pan - Half Size, 1 5/8" deep	CS1XLPH
Cooking pan - Full Size, 1 5/8" deep	CS2XLH
Cooking pan - Half Size, 1 5/8" deep	CS1XLH
Baking pan - Full Size, 1 1/8" deep	CS2LH
Wire rack	CSRACKH
Powder descaler	310967

The cooking pans may become warped during baking. This is due to major temperature fluctuations affecting the accessory, which may occur if food is placed on only one part of the accessory or a deep frozen item such as pizza has been placed on the accessory.

Water Tank

The water tank is located on the right when you open the appliance door.

Use only fresh tap water or purchased non-carbonated water to fill the water tank. If your water is very hard, we recommend using softened water.

If the tap water is highly chlorinated (> 40 mg/l), use non-carbonated mineral water with a low amount of chlorine. Contact your water utility company to find out what type of tap water you have.

Moisten the seal in the tank lid with some water prior to initial use.



CAUTION: Do not fill the water tank with distilled water or any other liquids.

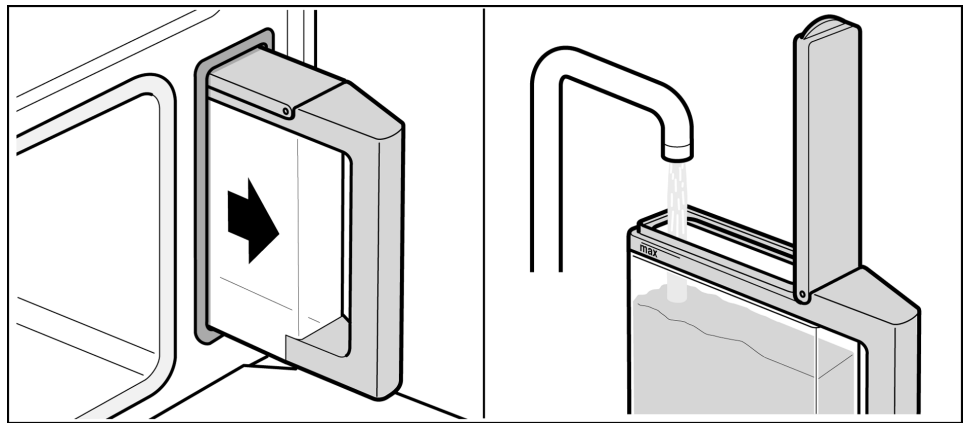

Before Each Use

Fill water tank before each use.

1. Fill the water tank with cold water up to the "max" mark.
2. Close the tank lid until it clearly snaps in place.
3. Slide in the water tank until it locks into position.

After Each Use

Empty the water tank after each use.

1. Keep the water tank level while slowly pulling it out of the appliance to ensure that no remaining water drips down and out through the vent.
2. Pour out the water.
3. Thoroughly dry the seal of the tank lid and the slot where the tank resides in the appliance.

Appears

The  display appears if you set the oven mode when the water tank is only half full.

If you think that the amount of water in the water tank is sufficient for what you want to cook, you can start the appliance.

If the water level is too low, then fill the water tank up to "max", slide the tank back in and then start the appliance.

Flashes

The  display flashes when the water tank is empty. A beep sounds and operation is stopped.

1. Carefully open the oven door. Steam will escape from inside.
2. Remove the water tank, fill it and slide it back in.
3. Press START/STOP.

Automatic Calibration

The temperature at which the water will boil depends on the air pressure. During calibration, the appliance is adjusted to the pressure conditions in the area where it has been installed. This takes place automatically the first time steam is used at 210 °F (100 °C). More steam than usual will be produced during calibration.

After Moving

To ensure that the appliance will automatically adjust to the new location, reset the appliance to its factory settings (see Basic Settings).

Getting Started

This section covers the following:

- Setting the clock after plugging in the appliance
- Changing the water hardness level, if necessary
- Cleaning the appliance prior to initial use

Setting the Clock

After plugging in the appliance, **00:00** flashes on the display.

Turn the settings dial to set the clock to the current time. The setting is automatically accepted after a few seconds.

Changing the Time

1. Press TIMER/CLOCK repeatedly until the arrow appears after the clock symbol  ◀.
2. Use the settings dial to set the current time.
3. Press TIMER/CLOCK to confirm.

Adjusting the Water Hardness Level

Descal the appliance using Decalcify mode at regular intervals. This can prevent damage to the appliance.

The appliance automatically informs when descaling is required. The factory setting is water hardness level II. Change the setting if your water is softer or harder.

Checking Water Hardness

Check the water hardness using the test strips provided or ask your water utility company.

Softened Water

Descaling is not required if you only use softened water. In this case, change the water hardness level to softened “-”.

Changing the Water Hardness Level

1. Press and hold ON/OFF until the appliance turns on.
2. Press and hold INFO for approximately 4 seconds.
The initial basic setting **00 1** appears in the display.
3. Press INFO repeatedly until **00 ?** (water hardness level) appears in the display.
4. Use the dial to change the water hardness level.
Options
 - softened
 - 1** 1-soft I
 - 2** 2-average II
 - 3** 3-hard III
 - 4** 4-very hard IV
5. Press and hold INFO for approximately 4 seconds.
The change is stored.

Cleaning

Before initial use, heat up the appliance once while empty and clean the accessories.

Heating Up the Appliance

1. Fill and slide in the water tank.
2. Press and hold ON/OFF to turn the appliance on.
OVEN MODE lights up on the display.
3. Use the settings dial to set the oven mode to Steam .
4. Press START/STOP to turn on the appliance.
The appliance automatically heats up to 210 °F (100 °C) and turns off after 20 minutes. A beep sounds.
5. Press and hold ON/OFF until the appliance turns off.
Leave the door open a crack until the appliance has cooled.

Cleaning Accessories Before Use

Clean the accessories thoroughly with soapy water and a cloth before initial use.

Operation

Operating the Appliance

This section covers the following:

- Turning the appliance on and off
- Important instructions to follow after each use

Turning On the Appliance

Example shown in the illustration:
Set the oven mode to Steam at 175 °F (80 °C).

1. Press and hold ON/OFF until the appliance turns on.

OVEN MODE lights up in the display. The first oven mode, True Convection , appears in the display.

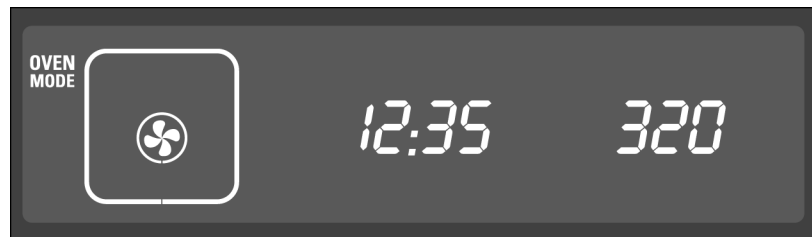

2. Use the settings dial to set the desired oven mode.
3. Press OVEN TEMP and use the settings dial to set the temperature.

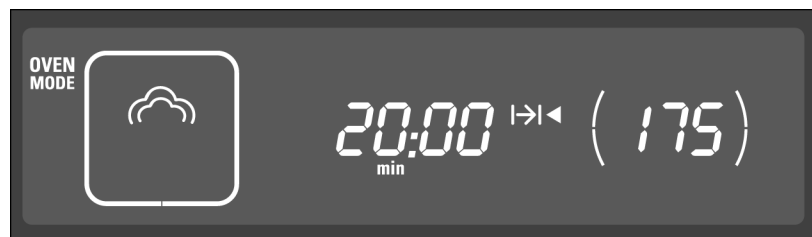

4. Press TIMER/CLOCK repeatedly until the arrow appears after the  Cook Time symbol.
5. Use the settings dial to set the Cook Time (see Clock and Timer Settings).
6. Press START/STOP to turn on the appliance.

The appliance starts to heat up. When using Steam mode, the Cook Time starts after the appliance is preheated.

Changing the Temperature

After Cook Time starts, you can turn the settings dial at any time to change the temperature.

Changing the End Time

See Clock and Timer Settings, Changing the End Time.

Turning Off the Appliance



WARNING: Risk of severe burns!

Hot steam may escape when opening the appliance door. Carefully open the door only after cooking is finished.

At the End of Cook Time

If you set a cook time, the appliance will turn off automatically. A beep sounds. Press **TIMER/CLOCK** to stop the signal.

Press and hold **ON/OFF** until the appliance turns off. Carefully open the appliance door.

Pausing Operation

Press **START/STOP** or open the appliance door. The appliance pauses operation. **START/STOP** flashes.

Close the appliance door and press **START/STOP** to resume operation.

If you activated Autostart, the appliance will not resume operation (see Basic Settings).

Canceling Operation

Press and hold **ON/OFF** to cancel operation and turn off the appliance.

The cooling fan may continue to run when you open the appliance door.

After Each Use

Emptying the Water Tank

Empty the water tank. Thoroughly dry the tank lid seal and the tank slot in the appliance.

Do not dry the water tank in the hot oven. This will damage the water tank.

Drying the Oven

Leave the door open a crack until the appliance has cooled.



WARNING: Risk of severe burns!

The water in the evaporator dish may be hot. Let it cool down before wiping it out.

Wipe down the oven cavity and the evaporator dish with the sponge provided and dry well with a soft cloth.

Remove food residue and spills from the oven immediately after the appliance has cooled down. Burned on residue is very difficult to remove at a later time.

Wipe dry furnishings or handles if condensation has formed on them.

Automatic Shutoff

The appliance features an automatic shutoff function. Automatic shutoff is activated when the settings have not been changed over an extended period of time. The time when automatic shutoff is activated is based on the temperature selected.

Shutoff Activated

FB appears in the display.



Operation is interrupted.

Press any touchpad to make the display indicator disappear. You can now adjust the settings.





Clock and Timer Settings

Use TIMER/CLOCK to access the clock and timer settings. The following options are available:

If the appliance is off

-  = sets the timer
-  = sets the clock

If the appliance is on

-  = sets the timer
-  = sets the Cook Time, if applicable
-  = changes the End Time, if applicable
-  = displays the time

Short Beep

A short beep will sound when you are not permitted to change or adjust a setting.

Setting the Timer

The timer functions separately from operation of the appliance. It can be used as a kitchen timer and can be set at any time.

1. Press TIMER/CLOCK.

The arrow appears after the Timer symbol ◀.

2. Use the settings dial to set the timer.

The timer is set for “minutes:seconds”.

The timer runs on the display for a few seconds. It then moves to the background. The  symbol indicates that the timer is running.

Accessing the Running Timer

Press TIMER/CLOCK. The timer appears for a few seconds.

Changing the Timer

Press TIMER/CLOCK. Use the settings dial to change the timer.

Canceling the Timer

Press TIMER/CLOCK and turn the settings dial to reset the timer to 00:00. The timer disappears after a few seconds.

After the Timer Runs Out

A beep sounds. 00:00 ◀ appears on the display. Press TIMER/CLOCK to cancel the signal.

Setting the Cook Time

If you set Cook Time for your dish, operation automatically stops at the end of the programmed time. The appliance stops heating.

Cook Time must always be set when using oven modes with steam.

Example shown in the illustration:

Set Cook Time to 35 minutes.

Requirement:

An oven mode and temperature must be set.

1. Press TIMER/CLOCK repeatedly until the arrow appears after the I→I◀ Cook Time symbol.

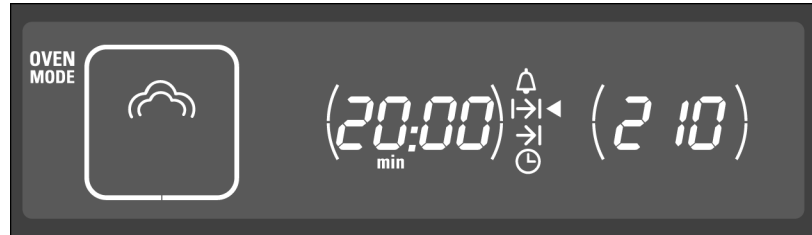

2. Use the settings dial to set the Cook Time.

The Cook Time is accepted after a few seconds. The parentheses to the left and right of the Cook Time disappear. The I→I◀ symbol lights up

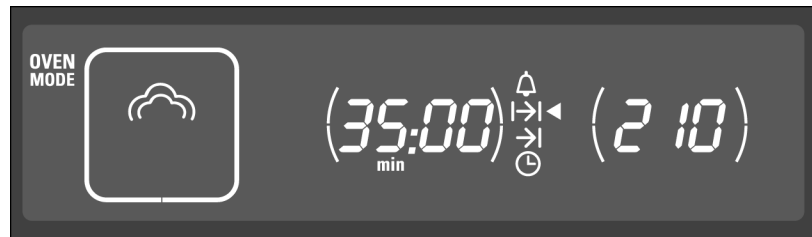

3. If operation has not yet started, press START/STOP.

The running Cook Time is visible in the display.

When using Steam mode, the Cook Time starts after the appliance is preheated.

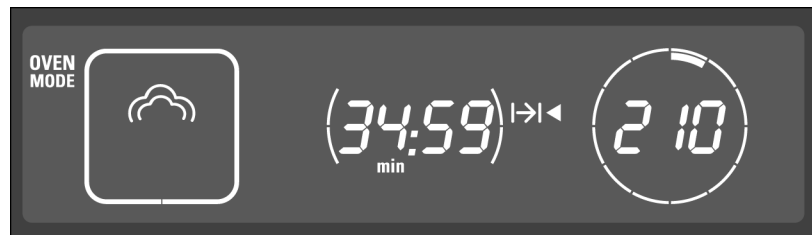

At the End of Cook Time

A beep sounds. The appliance stops heating. Press TIMER/CLOCK to stop the signal early.

Open the oven door and use potholders to carefully remove ovenware. Press and hold ON/OFF until the appliance turns off.

Changing the Cook Time

Press TIMER/CLOCK repeatedly until the arrow appears after the I→I◀ Cook Time symbol. Use the settings dial to change the Cook Time. The changed Cook Time starts.

Checking Time Settings

Use TIMER/CLOCK to check all settings.

Changing the End Time

You can change the time when the food will be done. The appliance starts automatically and turns off at the preferred End Time.

If the appliance is set to 12-hour mode, the End Time can only be delayed for up to 12 hours (see Basic Settings).



CAUTION: To maintain food safety, do not leave food in the oven for more than one hour before and after cooking.

Some programs do not allow the End Time to be changed.

The time required for preheating when using steam must be considered when setting the Cook Time. The set End Time can be delayed to make up for the time required for preheating.

The example is shown in the illustration:

It is 9:30 a.m. The food takes 45 minutes to cook, but should not be ready until 12:45 p.m.

Delaying the End Time

Requirement:

The set mode has not started. A Cook Time has been set.

1. Press TIMER/CLOCK repeatedly until the arrow appears after the End Time symbol →|◀.

The bars in the display indicate that the End Time has not been changed.



2. Use the settings dial to set the End Time to a later time.

3. Press START/STOP to confirm.

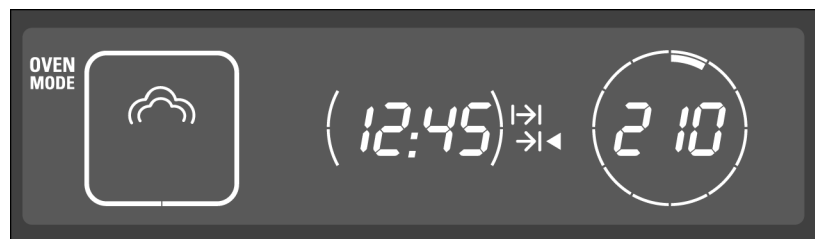

The setting is accepted. The appliance is in delayed mode. The End Time →|◀ is displayed.

Operation starts automatically at the correct time. In the example, operation starts at 12:00 p.m. The running Cook Time |→|◀ then appears in the display.

Adjusting the End Time

The End Time can be adjusted as long as the appliance is in delayed mode. To do this, use TIMER/CLOCK to switch to End Time →|◀ and use the settings dial to adjust the End Time.

Canceling the End Time

The End Time can be adjusted as long as the appliance is in delayed mode. To do this, use TIMER/CLOCK to switch to End Time →|◀ and turn the settings dial to the left until ---:-- appears. Cook Time starts immediately.

At the End of Cook Time

A beep sounds. The appliance stops heating. Press TIMER/CLOCK to cancel the signal early.

Setting the Clock

The appliance must be off in order to set or change the clock.

After a Power Outage

After a power outage, four zeros flash in the display.

1. Use the settings dial to set the current time.
2. Press TIMER/CLOCK.

The clock setting is accepted.

Changing the Time

Example:

Switching daylight savings on or off on the clock.

1. Press TIMER/CLOCK repeatedly until the arrow appears after the Clock symbol .
2. Use the settings dial to change the time.
3. Press TIMER/CLOCK.

The new clock setting is accepted.

Changing the Clock Time Display Mode

The clock can display the time in 12-hour or 24-hour display mode (see Basic Settings).

Hiding the Time

When the appliance is off, the current time appears in the display. You can also hide the time. In this case, the time only appears when the appliance is turned on (see Basic Settings).

Automatic Programming - EasyCook

This section covers the following:

- Setting a program from automatic programming - EasyCook
- Information and tips on the programs
- Available programs

Automatic programming makes it easy to prepare food. There are 16 program groups with a total of 40 programs.

Setting a Program

Select the appropriate program from the program chart. Read the information on the programs.

The example is shown in the illustration:

To roast 3 lbs (1.4 kg) of fresh chicken (program P13):

1. Press and hold ON/OFF until the appliance turns on.
2. Press EASY COOK.

The first program *P01* and a suggested weight appear in the display.



3. Use the settings dial to select the preferred program.

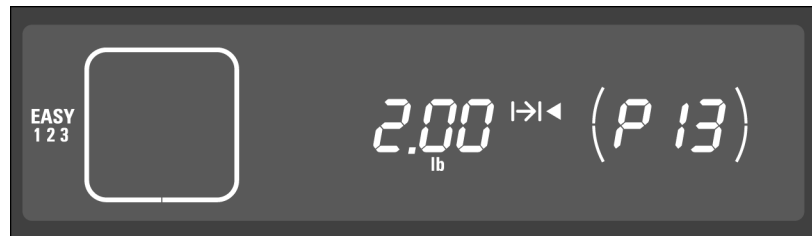

4. Press WEIGHT and use the settings dial to set the weight of the food.

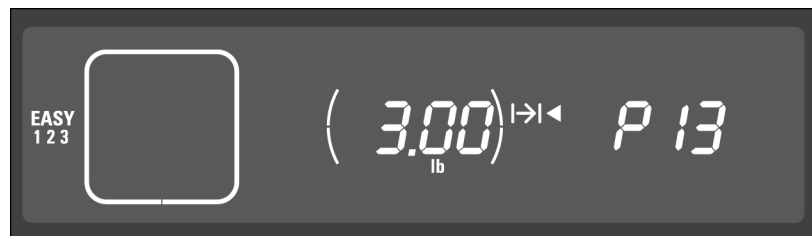

5. Press START/STOP to start the appliance.

The running cook time of the program I→I ◀ appears in the display.

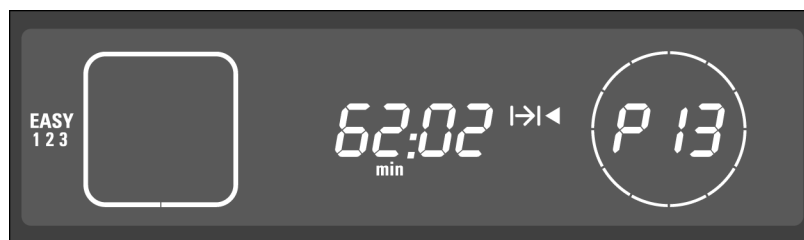

WARNING: Risk of severe burns!

Hot steam may escape when opening the oven door. Carefully open the door only after cooking is finished.

Changing the End Time

Some programs allow you to delay the end time. The program starts later and ends at the preferred time (see section: Clock and Timer Settings).

Clearing Settings

To clear all settings, press and hold START/STOP for four seconds. You can now set a new oven mode or a new program.

At the End of Cook Time

A beep sounds. Press TIMER/CLOCK to stop the signal early.

Open the oven door and use pot holders to carefully remove ovenware. Press and hold ON/OFF until the appliance turns off.

Canceling a Program

Press and hold ON/OFF to cancel operation and turn off the appliance.

Program Information

All programs are designed for cooking on one level.

Cooking results may vary depending on the amount and quality of the food.

Ovenware

Use the recommended ovenware. All meals have been tested using this ovenware. Cooking results may vary if different ovenware is used.

When cooking food in a perforated cooking pan, also insert the baking pan at rack level 1. The pan will catch any drippings.

Quantity/Weight

Add liquid and food mixtures such as rice and water no more than 1.6 inches up the side of the accessory.

Automatic programming requires the weight of the food. For individual pieces, like pieces of chicken, always enter the weight of the largest piece. The total weight must be within the preset weight range.

Cooking Time

The cooking time appears after the program starts. You can change it during the first 10 minutes, since the preheat time depends on conditions such as the temperature of the water and of the food being cooked.

EasyCook - Program Charts

This section covers all of the programs available for automatic programming. Read the instructions before using a program to prepare the food.

Vegetables

Wait until after cooking to season vegetables.

Program	Notes	Ovenware/accessories	Level
P1* Steam cauliflower florets	Florets of equal size	Perforated cooking pan + baking pan	3 1
P2* Steam green beans	-	Perforated cooking pan + baking pan	3 1
P3* Steam broccoli florets	Florets of equal size	Perforated cooking pan + baking pan	3 1
P4* Steam green asparagus	-	Perforated cooking pan + baking pan	3 1
P5 Steam mixed vegetables, frozen**	-	Perforated cooking pan + baking pan	3 1

* You can delay the end time for this program

** Can be used with all frozen vegetables

Potatoes

Wait until after cooking to season potatoes.

Program	Notes	Ovenware/accessories	Level
P6* Unpeeled boiled potatoes	Medium-size, 1.6-2 in. diam.	Perforated cooking pan + baking pan	3 1
P7* Boiled potatoes	Medium-sized, quartered, individual weight 1 - 1.4 oz (30 - 40 g)	Perforated cooking pan + baking pan	3 1

* You can delay the end time for this program

Cereals and grains

Weigh out the food to be cooked and add the correct amount of water:

Rice 1 : 1.5

Couscous 1 : 1

Enter the dry weight. One cup of rice equals 0.4 lbs.

Stir the cereal or grain after cooking. This will help it quickly absorb the remaining water.

To prepare risotto:

Add water to the risotto at a ratio of 1 to 2. Enter the entire weight, including the water. One cup of risotto and 2 cups of water equal approximately 1.5 lbs. The message "stir" will appear after approximately 15 minutes. Stir the risotto.

Program	Notes	Ovenware/accessories	Level
P8 Basmati rice	max. 1.7 lbs. (0.75 kg)	Cooking pan	2
P9 Brown rice	max. 1.7 lbs. (0.75 kg)	Cooking pan	2
P10 Long grain rice	max. 1.7 lbs. (0.75 kg)	Cooking pan	2
P11 Couscous	max. 1.7 lbs. (0.75 kg)	Cooking pan	2
P12 Risotto, Arborio rice	max. 4.5 lbs. (2 kg)	Cooking pan	2

Poultry

Do not place pieces of chicken on top of each other in the ovenware. You can marinate the pieces of chicken before cooking.

Program	Notes	Ovenware/accessories	Level
P13 Whole chicken, fresh	Total weight 1.5 - 4.5 lbs. (0.7 - 1.5 kg)	Wire rack + baking pan	2
P14 Chicken parts	Total weight 0.3 - 1.2 lbs. (0.04 - 0.35 kg)	Wire rack + baking pan	2

Beef

A tall roast is recommended for roast beef.

Program	Notes	Ovenware/accessories	Level
P15 Sirloin, fresh, slow cook, medium**	Total weight 2 - 4.5 lbs. (1 - 2 kg)	Baking pan	2
P16* Pot roast (chuck), fresh	1 - 3.5 lbs. (1 - 1.5 kg)	Baking pan	2

* You can delay the end time for this program

** Sear the meat before cooking

Pork

Cut the rind from the center outward prior to cooking.

The shoulder cut is the best cut for a roast with crust.

Program	Notes	Ovenware/accessories	Level
P17* Roast, fresh	2 - 4.5 lbs. (0.8 - 2 kg)	Wire rack + baking pan	2

* You can delay the end time for this program

Lamb

Program	Notes	Ovenware/accessories	Level
P18 Leg, fresh, boned, well done	2 - 4.5 lbs. (1 - 2 kg)	Wire rack + baking pan	2
P19 Leg, fresh, boned, slow cook, medium*	2 - 4.5 lbs. (1 - 2 kg)	Baking pan	2

* Sear the meat well beforehand

Fish

Grease the perforated cooking pan to prepare for the fish.

Do not place whole fish, fish fillets or fish sticks on top of each other. Enter the weight of the heaviest piece of fish and select pieces that are approximately the same size.

Program	Notes	Ovenware/accessories	Level
P20 Steaming whole fresh fish	0.5 - 4.5 lbs. (0.3 - 2 kg)	Perforated cooking pan + baking pan	3 1
P21 Steaming fish fillets, fresh	max. 1 in. thick	Perforated cooking pan + baking pan	3 1
P22 Steaming fish fillets, frozen	max. 1 in. thick	Perforated cooking pan + baking pan	3 1
P23 Oysters and clams	-	Perforated cooking pan + baking pan	2

Baked goods, desserts

Preparing fruit compote

This program is suitable for fruits with stones and pits only. Weigh out the fruit, add approximately $\frac{1}{3}$ of water and add sugar and spices to taste.

Preparing rice pudding

Weigh out the rice and add 2.5 times as much milk. Add the rice and milk no more than 1 inch up the side of the accessory. Stir after cooking. The remaining milk will be absorbed quickly.

Program	Notes	Ovenware/accessories	Level
P24* Fruit compote	-	Baking pan	2
P25 Rice pudding	-	Baking pan	2

* You can delay the end time for this program

Bread, bread rolls

Use parchment paper on the baking pan when baking bread and bread rolls.

Baking bread

The programs are for free-form loaves only. Baking bread in a loaf pan is not recommended. The dough should not be too soft. Before baking, use a sharp knife to make several slashes about 0.4 inches deep into the bread dough.

Let the dough rise and then bake

A beep will sound after approximately 20 minutes. Make slash marks in the dough and then press START/STOP.

Baking fresh bread rolls

The rolls should all weigh the same. Enter the weight of the individual bread rolls.

Program	Notes	Ovenware/accessories	Level
P26* White bread, bake	1 - 4.5 lbs. (0.4 - 2 kg)	Baking pan	2
P27 White bread, proof and bake	Note the message	Baking pan	2
P28* Multigrain bread, bake	1.25 - 4.5 lbs. (0.6 - 2 kg)	Baking pan	2

* You can delay the end time for this program

Program	Notes	Ovenware/accessories	Level
P29 Multigrain bread, proof and bake	Note the message	Baking pan	2
P30* Rye bread, bake	1.25 - 4.5 lbs. (0.6 - 2 kg)	Baking pan	2
P31 Rye bread, proof and bake	Note the message	Baking pan	2
P32* Fresh bread rolls, bake	Weight per piece 0.1 - 0.3 lbs. (0.05 - 0.1 kg)	Baking pan	2
P33 Frozen bread rolls, bake	Total weight 0.5 - 2.5 lbs. (0.2 - 1 kg)	Baking pan	2

* You can delay the end time for this program

Reheat

Program	Notes	Ovenware/accessories	Level
P34* Pizza, cooked, thin crust	-	Wire rack + baking pan	3
P35* Pizza, cooked, deep dish	-	Wire rack + baking pan	3

* You can delay the end time for this program

Defrosting

Freeze the food as flat as possible and in appropriate portions at -0 °F (-18 °C). Do not freeze oversized portions. Defrosted food does not keep as long and spoils more quickly than fresh food.

Defrost food in the freezer bag on a plate or in the perforated cooking pan. Always slide the baking pan under the perforated cooking pan. This keeps the food from lying in the defrosted water and keeps the oven clean.

All defrost programs assume the food is raw.

If necessary, while the food is thawing, split it up or take pieces that have already thawed out of the appliance.

Let the food sit for another 5 to 15 minutes after it has thawed to complete defrosting.



WARNING: Health hazard!

When defrosting animal food products, make sure to remove the thawed liquid. The liquid must not come into contact with other food products.

Germs could be transferred to the other food.

After the food has thawed, heat up the steamer oven using True Convection for 15 minutes at 360 °F (180 °C.).

Defrost whole bird

Remove the packaging before defrosting.

Let the bird sit for some time after it has thawed. For large chickens, you can remove the giblets after resting for approximately 30 minutes.

Defrost meat

Use this program to defrost individual cuts of roast.

Thaw fruit only

If you only want to thaw fruit slightly, adjust the cooking results based on the individual fruit.

Program	Notes	Ovenware/accessories	Level
P36 Chicken pieces, bone-in	max. 4.5 lbs. (1.8 kg)	Perforated cooking pan + baking pan	3 1
P37 Meat	max. weight 3.5 lbs. (1.5 kg) per piece	Perforated cooking pan + baking pan	3 1
P38 Berries	-	Perforated cooking pan + baking pan	3 1

Special items

Cooking eggs

Pierce holes in eggs before cooking. If eggs are not pierced, they may burst during cooking. Do not place eggs on top of each other. One large egg weighs approx. 2 oz. (57 g).

Program	Notes	Ovenware/accessories	Level
P39* Soft-boiled eggs	Eggs, large, max. 2 lbs. (1 kg)	Perforated cooking pan + baking pan	3 1
P40* Hard-boiled eggs	Eggs, large, max. 4 lbs. (1.8 kg)	Perforated cooking pan + baking pan	3 1

* You can delay the end time for this program

Favorites

Use FAVORITES to store and access 6 custom programs at any time. FAVORITES is useful if you frequently prepare particular types of meals. You can also store a meal from automatic programming.

Storing a Setting in Favorites

1. Set the preferred mode. Do not start the oven.
2. Briefly press FAVORITES and use the settings dial to select the memory setting.

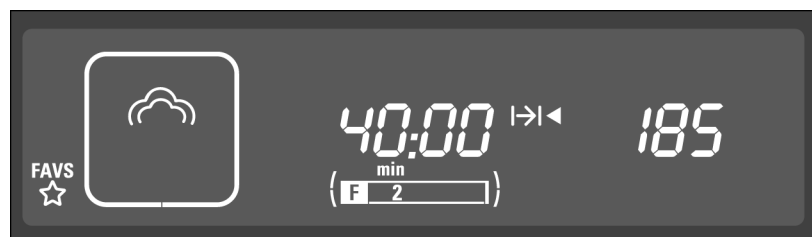

3. Press and hold FAVORITES until the ✓ symbol appears after the memory setting. The setting is stored and can be started at any time.

Storing a Different Setting

Enter a new setting and store it.
This will override the old setting.

Canceling a FAVORITES Setting

Press and hold START/STOP.

Starting a Favorites Setting

You can start stored settings at any time.

1. Briefly press FAVORITES and use the settings dial to select the memory setting.
The stored settings are displayed.
2. Press START/STOP.
The FAVORITES setting starts.

Changing the Memory Setting

Once a setting is started, you cannot change it.

Canceling a FAVORITES Setting

Press and hold START/STOP until True Convection mode  appears.
You can now adjust the settings.

Deleting a Favorites Setting

If you change the basic setting **C 0 1**, **C 0 9**, **C 1 0** or **C 1 1** all FAVORITES settings are cleared (see: Basic Settings).

Panel Lock

The appliance features a panel lock to prevent children from accidentally turning it on.

Activation

Turn off the appliance. Press and hold PANEL LOCK for approximately four seconds until the  symbol appears.

The panel lock is activated.

Deactivation

Press PANEL LOCK until the  symbol disappears.

The panel lock is deactivated.

Note:

You can still set the timer while the panel lock is activated.

Basic Settings

The appliance features various basic settings preset in the factory. These basic settings can, however, be changed as necessary.

You can restore the factory settings to reverse any changes.

The example is shown in the illustration:

To change the basic setting for the Cook Time signal from short to long.

1. Press and hold ON/OFF until the appliance turns on.
2. Press and hold INFO for approximately 4 seconds.

The first basic setting **CO1** appears in the display.

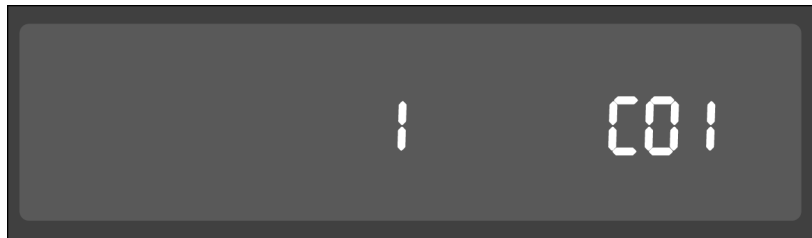

3. Press INFO repeatedly until the desired basic setting appears.
4. Use the settings dial to change the basic setting.



Now you can press INFO to select additional basic settings and change them using the settings dial.

5. Press and hold INFO for approximately 4 seconds.

All changes are saved.

Canceling Changes

Press START/STOP. The changes are not saved.

The following basic settings can be changed:

Basic setting	Function	Options
C01* National code	Preselection of units and clock display mode: USA - °F, 12-hour mode, lbs. Canada - °C, 24-hour mode, kg	0 = none 1 = USA 2 = Canada
C02 Clock display	When the appliance is off	0 = off 1 = on
C03 Time	Sets current time	
C04 Touchpad sound	Sound emitted when a touchpad is pressed	0 = off 1 = on
C05 Cook Time signal	Signal after Cook Time ends	1 = short 2 = medium 3 = long
C06 Oven Autostart	Autostart activated: Oven does not restart after oven door is opened	0 = off 1 = on
C07 Water hardness level	Water hardness level setting for the Decalcify indicator	– = softened 1 = soft 2 = average 3 = hard 4 = very hard
C08 Calibration	Resets calibration. The appliance is recalibrated the next time Steam mode is used at 210°F (100°C)	0FF = reset off 0n = reset on
C09* Temperature units	Temperatures are indicated in °F. If you switch to °C, "°C" also appears in the display.	0 = °F 1 = °C
C10* Clock display mode	The clock in the display appears in 12-hour or 24-hour mode	0 = 12-hour mode 1 = 24-hour mode
C11* Weight units	Weights can be displayed in lbs. or kg	0 = lbs. 1 = kg
C12 Display brightness	Sets the display brightness	8 levels: 0 (dark) - 7 (bright)

* If you change the basic setting, all Favorites settings are cleared (see: Favorites)

Adjustable display brightness:

Getting the Most Out of Your Appliance

Cooking Tables and Tips

These tables contain a selection of dishes that can be easily prepared in the steamer oven. You can find out which oven mode, accessories and cooking time are best suited for your dish. If not specified otherwise, this information applies to dishes placed in a cold appliance.



WARNING: Do not use aluminum foil or protective liners to line any part of the appliance, especially the oven bottom. Installing these liners may result in risk of electric shock or fire.

Accessories

Use the accessories that come with the appliance.

When using steam with a perforated cooking pan, always slide the baking pan underneath it. The baking pan will catch any drippings.

Ovenware

If you use ovenware, always place it in the center of the rack.

The ovenware must be heat and steam resistant. Thick-walled ovenware extends the cooking time.

Use foil to cover food that would normally be prepared in a water bath (such as when melting chocolate).

Steaming

Steaming is a particularly gentle way to cook food. The steam envelopes the food, preventing the food from losing nutrients. No excess pressure is needed for cooking, allowing the food to maintain its shape, color and typical flavor.

Cooking Times and Quantities

When steaming, the cooking times are based on the size of the piece, not on the entire quantity of food. The appliance can steam up to 4.5 lbs. (2 kg) of food.

Note the sizes of pieces listed in the tables. The cooking time is shorter for smaller pieces and longer for larger pieces. The quality and age of the food also affect the cooking time. The values provided therefore serve only as a guideline.

Distribute Food Evenly

Always distribute the food evenly in the ovenware. If the food is placed unevenly in the ovenware, it will cook unevenly.

Delicate Food

Do not layer delicate foods too high in the cooking pan. It is better to use two pans in this case.

Cooking an Entire Meal

You can cook entire meals at the same time in Steam mode without mixing the flavors of the different food. Place the food with the longest cooking time in the appliance first and then add the remaining dishes at the appropriate time. This will ensure that all dishes are ready at the same time.

The total cooking time will be longer when cooking an entire meal, since every time the appliance door is opened, some steam escapes and the appliance has to reheat.

True Convection

True Convection is particularly suited for sweet and savory baked goods, braised meat and various cakes.

Vegetables

Place vegetables in the perforated cooking pan and place pan at rack level 3. Place the baking pan underneath it at rack level 1. The baking pan will catch any drippings.

Food	Size	Accessories	Oven mode	Temperature	Cooking time
Artichokes	Whole	Perforated + baking pan	Steam	210°F (100°C)	30 - 35 min.
Cauliflower	Whole	Perforated + baking pan	Steam	210°F (100°C)	30 - 40 min.
Cauliflower	Florets	Perforated + baking pan	Steam	210°F (100°C)	10 - 15 min.
Broccoli	Florets	Perforated + baking pan	Steam	210°F (100°C)	8 - 10 min.
Peas	–	Perforated + baking pan	Steam	210°F (100°C)	5 - 10 min.
Fennel	Slices	Perforated + baking pan	Steam	210°F (100°C)	10 - 14 min.
Stuffed vegetables (zucchini, eggplant, peppers)	Do not precook vegetables	Baking pan at level 2	Combination	320 - 360°F (160 - 180°C)	15 - 30 min.
Green beans	–	Perforated + baking pan	Steam	210°F (100°C)	15 - 20 min.
Carrots	Slices	Perforated + baking pan	Steam	210°F (100°C)	10 - 20 min.
Kohlrabi	Slices	Perforated + baking pan	Steam	210°F (100°C)	15 - 20 min.
Leeks	Slices	Perforated + baking pan	Steam	210°F (100°C)	4 - 6 min.
Swiss chard*	Shredded	Perforated + baking pan	Steam	210°F (100°C)	8 - 10 min.

* Preheat the appliance

Food	Size	Accessories	Oven mode	Temperature	Cooking time
Green asparagus*	Whole	Perforated + baking pan	Steam	210°F (100°C)	7 - 12 min.
White asparagus*	Whole	Perforated + baking pan	Steam	210°F (100°C)	10 - 15 min.
Spinach*	–	Perforated + baking pan	Steam	210°F (100°C)	2 - 3 min.
Brussels sprouts	Florets	Perforated + baking pan	Steam	210°F (100°C)	20 - 30 min.
Red beets	Whole	Perforated + baking pan	Steam	210°F (100°C)	40 - 50 min.
Red cabbage	Shredded	Perforated + baking pan	Steam	210°F (100°C)	30 - 35 min.
Cabbage	Shredded	Perforated + baking pan	Steam	210°F (100°C)	25 - 35 min.
Zucchini	Slices	Perforated + baking pan	Steam	210°F (100°C)	2 - 3 min.
Pea pods	–	Perforated + baking pan	Steam	210°F (100°C)	8 - 12 min.

* Preheat the appliance

Side Dishes and Legumes

Add the appropriate amount of water or liquid.

Example: 1 : 1.5 = for every 1/2 cup of rice, add 3/4 cup of water.

You can choose any rack level for the cooking pan.

Food	Ratio/ information	Accessories	Oven mode	Temperature	Cooking time
Unpeeled boiled potatoes	Medium size	Perforated (level 3) + baking pan (level 1)	Steam	210°F (100°C)	35 - 45 min.
Boiled potatoes	Quartered	Perforated (level 3) + baking pan (level 1)	Steam	210°F (100°C)	20 - 25 min.
Potato gratin	–	Baking pan (level 2)	True Convection	340 - 360°F (170 - 180°C)	35 - 45 min.
Brown rice	1 : 2	Cooking pan	Steam	210°F (100°C)	30 - 40 min.
Long grain rice	1 : 2	Cooking pan	Steam	210°F (100°C)	20 - 30 min.
Basmati rice	1 : 1.5	Cooking pan	Steam	210°F (100°C)	20 - 30 min.
Parboiled rice	1 : 1.5	Cooking pan	Steam	210°F (100°C)	15 - 20 min.
Lentils	1 : 2	Cooking pan	Steam	210°F (100°C)	30 - 45 min.
Canellini beans, pre-softened	1 : 2	Cooking pan	Steam	210°F (100°C)	65 - 75 min.

Food	Ratio/ information	Accessories	Oven mode	Temperature	Cooking time
Couscous	1 : 1	Cooking pan	Steam	210 °F (100 °C)	6 - 10 min.
Dumplings	–	Perforated (level 3) + baking pan (level 1)	Steam	205 °F (95 °C)	20 - 25 min.

Meat, poultry, fish

Insert rack and baking pan together at the same rack level.

Once the roast is done, let it rest in the closed steamer oven for an additional 10 minutes after turning it off. This will help the meat retain its juices.

Using the Combination oven mode makes the meat particularly tender and juicy on the inside while forming a crust on the outside.

Poultry

Food	Amount/ weight	Accessories	Level	Oven mode	Temperature	Cooking time
Chicken, whole	2.65 lbs (1.2 kg)	Wire rack + baking pan	2	Combination	360 - 375 °F (180 - 190 °C)	50 - 60 min.
Chicken, halved	per 1 lbs (0.4 kg)	Wire rack + baking pan	2	Combination	360 - 375 °F (180 - 190 °C)	35 - 45 min.
Chicken breast	per 0.33 lbs (0.15 kg)	Perforated + baking pan	3 1	Steam	210 °F (100 °C)	15 - 25 min.
Chicken pieces	per 2.65 lbs (1.2 kg)	Wire rack + baking pan	2	Combination	360 - 390 °F (180 - 200 °C)	20 - 35 min.
Duck, whole	4.5 lbs (2 kg)	Wire rack + baking pan	2	Combination True Convection	340 °F (170 °C) 410 °F (210 °C)	60 - 80 min. 15 - 20 min.
Duck breast*	per 0.77 lbs (0.35 kg)	Wire rack + baking pan	2	Combination	340 - 360 °F (170 - 180 °C)	10 - 15 min.
Turkey, whole, unstuffed	8 - 11 lbs	Wire rack + baking pan	1	Combination	325 °F (165 °C)	50 - 75 min.
Turkey, whole, unstuffed**	12 - 14 lbs	Wire rack + baking pan	1	Combination	325 °F (165 °C)	80 - 95 min.
Rolled turkey roast	3.5 lbs (1.5 kg)	Wire rack + baking pan	2	Combination	300 - 320 °F (150 - 160 °C)	70 - 90 min.
Turkey Breast	2 lbs (1 kg)	Wire rack + baking pan	2	Combination	300 - 320 °F (150 - 160 °C)	60 - 80 min.

* Sear first

** Use baking pan 1 5/8 " deep (see Additional Accessories)

Beef

Food	Amount/ weight	Accessories	Level	Oven mode	Temperature	Cooking time
Pot-roasted beef*	3.5 lbs (1.5 kg)	Wire rack + baking pan	2	Reheat	285 - 300°F (140 - 150°C)	100 - 140 min.
Fillet of beef, medium*	2 lbs (1 kg)	Wire rack + baking pan	2	Reheat	340 - 360°F (170 - 180°C)	20 - 28 min.
Thin slice of roast beef, medium*	2 lbs (1 kg)	Wire rack + baking pan	2	True Convection	340 - 360°F (170 - 180°C)	40 - 55 min.
Thick cut of sirloin, medium*	2 lbs (1 kg)	Wire rack + baking pan	2	True Convection	340 - 360°F (170 - 180°C)	45 - 60 min.

* Sear first

Veal

Food	Amount/ weight	Accessories	Level	Oven mode	Temperature	Cooking time
Veal, bone-in	3.5 lbs (1.5 kg)	Wire rack + baking pan	2	Combination	320 - 360°F (160 - 180°C)	50 - 70 min.
Veal loin*	2 lbs (1 kg)	Wire rack + baking pan	2	Combination	320 - 360°F (160 - 180°C)	15 - 25 min.
Breast of veal, stuffed	3.5 lbs (1.5 kg)	Wire rack + baking pan	2	Combination	285 - 320°F (140 - 160°C)	75 - 120 min.

* Sear first

Pork

Food	Amount/ weight	Accessories	Level	Oven mode	Temperature	Cooking time
Bone-in without rind	3.5 lbs (1.5 kg)	Wire rack + baking pan	2	Combination	340 - 360°F (170 - 180°C)	70 - 80 min.
Bone-in with rind	3.5 lbs (1.5 kg)	Wire rack + baking pan	2	Steam	210°F (100°C)	20 - 25 min.
				Combination	285 - 320°F (140 - 160°C)	40 - 50 min.
				True Convection	410 - 430°F (210 - 220°C)	20 min.
Pork chop, boneless*	1.2 lbs (0.5 kg)	Wire rack + baking pan	2	Combination	320 - 360°F (160 - 180°C)	20 - 30 min.

* Sear first

Food	Amount/ weight	Accessories	Level	Oven mode	Temperature	Cooking time
Fillet in puff pastry	2 lbs (1 kg)	Baking pan	2	Combination	360 - 390°F (180 - 200°C)	40 - 60 min.
Smoked pork on the bone	2 lbs (1 kg)	Wire rack + baking pan	2	Combination	250 - 285°F (120 - 140°C)	60 - 70 min.
Smoked pork ribs	Sliced	Baking pan	2	Steam	210°F (100°C)	15 - 20 min.
Rolled roast	3.5 lbs (1.5 kg)	Wire rack + baking pan	2	Combination	340 - 360°F (170 - 180°C)	70 - 80 min.

* Sear first

Other

Food	Amount/ weight	Accessories	Level	Oven mode	Temperature	Cooking time
Meat loaf	Made from 1.2 lbs (0.5 kg) ground meat	Baking pan	2	Combination	340 - 360°F (170 - 180°C)	45 - 60 min.
Boned leg of lamb	3.5 lbs (1.5 kg)	Wire rack + baking pan	2	Combination	340 - 360°F (170 - 180°C)	60 - 80 min.
Loin of lamb on the bone*	3.5 lbs (1.5 kg)	Wire rack + baking pan	2	Combination	320 - 340°F (160 - 170°C)	15 - 25 min.
Wiener sausages	–	Perforated + baking pan	3 1	Steam	175 - 185°F (80 - 85°C)	12 - 18 min.

* Sear first

Fish

Food	Amount/ weight	Accessories	Level	Oven mode	Temperature	Cooking time
Whole	per 0.66 lbs (0.3 kg)	Perforated + baking pan	3 1	Steam	175 - 195°F (80 - 90°C)	15 - 25 min.
Fillet	per 3.5 lbs (1.5 kg)	Perforated + baking pan	3 1	Steam	175 - 195°F (80 - 90°C)	10 - 20 min.
Trout, whole	per 0.5 lbs (0.2 kg)	Perforated + baking pan	3 1	Steam	175 - 195°F (80 - 90°C)	12 - 15 min.
Cod fillet	per 0.33 lbs (0.15 kg)	Perforated + baking pan	3 1	Steam	175 - 195°F (80 - 90°C)	10 - 14 min.

Food	Amount/ weight	Accessories	Level	Oven mode	Temperature	Cooking time
Salmon fillet	per 0.33 lbs (0.15 kg)	Perforated + baking pan	3 1	Steam	210°F (100°C)	8 - 10 min.
Clams, oysters	0.33 lbs (0.15 kg)	Baking pan	2	Steam	210°F (100°C)	10 - 15 min.
Haddock, perch fillet	per 0.5 lbs (0.2 kg)	Perforated + baking pan	3 1	Steam	175 - 195°F (80 - 90°C)	10 - 20 min.
Stuffed sole rolls	–	Perforated + baking pan	3 1	Steam	175 - 195°F (80 - 90°C)	10 - 20 min.
Shrimp, large	per 1 lb (0.4 kg)	Perforated + cooking pan	3 1	Steam	210°F (100°C)	8 - 13 min.
Shrimp, medium	per 1 lb (0.4 kg)	Perforated + cooking pan	3 1	Steam	210°F (100°C)	5 - 8 min.

Roasting Tips

When is the roast done?	Use a food thermometer (available in stores) to measure the meat temperature.
The roast is too dark and crust is burned in some areas.	Check the rack level and temperature.
The roast turned out well, but the sauce is burned.	Next time, use a smaller roasting pan or add more liquid.
The roast looks good, but the sauce is too light and runny.	Next time, use a larger roasting pan or add less liquid.

Slow Cooking Meat

Slow cooking is ideal for cooking all tender cuts of meat that will be cooked medium rare. The meat stays very moist and is tender.

Place the baking pan in the combination oven and preheat the oven using Slow Cook mode.

Sear the meat well on all sides on the cooktop.

Place the meat in the preheated combination oven and continue to slow cook.

After it is done, arrange it on preheated plates and add a warm sauce on top.

Food	Amount	Accessories	Level	Temperature	Cooking time
Boned leg of lamb	2 - 3.5 lbs. (1 - 1.5 kg)	Baking pan	2	175°F (80°C)	140 - 160 min.
Roast beef	3.5 - 5.5 lbs. (1.5 - 2.5 kg)	Baking pan	2	175°F (80°C)	150 - 180 min.

Food	Amount	Accessories	Level	Temperature	Cooking time
Pork fillets	–	Baking pan	2	175 - 195°F (80 - 90°C)	50 - 70 min.
Pork medallions	–	Baking pan	2	175°F (80°C)	60 - 60 min.
Beef steaks	approx. 1.2 in. thick	Baking pan	2	175°F (80°C)	40 - 80 min.
Duck breast	–	Baking pan	2	175°F (80°C)	35 - 55 min.

Soufflés, Casseroles, Additions to Soups, etc.

Food	Accessories	Level	Oven mode	Temperature	Cooking time
Lasagna	Baking pan	2	Combination	320 - 340°F (160 - 170°C)	35 - 45 min.
Soufflés	Soufflé dish + wire rack	2	Combination	360 - 390°F (180 - 200°C)	15 - 25 min.
Semolina dumplings	Perforated + baking pan	3 1	Steam	195 - 205°F (90 - 95°C)	7 - 10 min.

Desserts, compote

Compote

Weigh out the fruit, add approximately $\frac{1}{3}$ of water and add sugar and spices to taste.

Rice pudding

Weigh out the rice and add 2.5 times as much milk. Add the rice and milk no higher than 1 inch up the side of the accessory. Stir after cooking. The remaining milk will be absorbed quickly.

Yogurt

Heat the milk on the cooktop to 195°F (90°C). Remove from heat and let cool to 105°F (40°C). Heating the milk is not required if using ultra high temperature (UHT) milk.

Stir in one to two teaspoons of plain yogurt, or the appropriate amount of yogurt starter per 100 ml of milk. Pour the mixture into clean glass jars and cover with lids.

After preparation, place the jars in the refrigerator to cool.

Food	Accessories	Oven mode	Temperature	Cooking time
Yeast dumplings	Baking pan	Steam	210°F (100°C)	20 - 25 min.
Egg custard	Mold + wire rack	Steam	195 - 205°F (90 - 95°C)	15 - 20 min.

* You can also use the relevant program (see Automatic Programming).

Food	Accessories	Oven mode	Temperature	Cooking time
Sweet baked items (such as rice pudding)	Ovenproof dish + wire rack	Combination	320 - 340 °F (160 - 170 °C)	50 - 60 min.
Rice pudding*	Baking pan	Steam	210 °F (100 °C)	25 - 35 min.
Yogurt	Portion-sized jars + wire rack	Steam	105 °F (40 °C)	300 - 360 min.
Apple compote	Baking pan	Steam	210 °F (100 °C)	10 - 15 min.
Pear compote	Baking pan	Steam	210 °F (100 °C)	10 - 15 min.
Cherry compote	Baking pan	Steam	210 °F (100 °C)	10 - 15 min.
Rhubarb compote	Baking pan	Steam	210 °F (100 °C)	10 - 15 min.
Plum compote	Baking pan	Steam	210 °F (100 °C)	15 - 20 min.

* You can also use the relevant program (see Automatic Programming).

Cakes and Baked Goods

Dark metal baking pans are recommended.

The temperature and cooking time depend on the quantity and consistency of the dough. Temperature ranges are therefore provided in the charts.

Start with a lower temperature setting. This will provide for more even browning. Use a higher temperature setting the next time, if necessary.

Do not overfill the rack or baking pan.

Cake in Molds or Springform Pans

Food	Accessories	Level	Oven mode	Temperature	Cooking time
Sponge cake	10-inch tube pan	2	True Convection	300 - 320 °F (150 - 160 °C)	60 - 70 min.
Sponge flan base	Ring	2	True Convection	300 - 320 °F (150 - 160 °C)	30 - 45 min.
Delicate fruit flan, sponge	Springform cake pan	2	True Convection	300 - 320 °F (150 - 160 °C)	45 - 55 min.
Sponge base (2 eggs)	Ring	2	True Convection	360 - 375 °F (180 - 190 °C)	12 - 16 min.
Sponge flan (6 eggs)	Springform cake pan	2	True Convection	300 - 320 °F (150 - 160 °C)	25 - 35 min.
Shortcrust pastry base with crust	Springform cake pan	2	True Convection	300 - 320 °F (150 - 160 °C)	40 - 50 min.
Swiss flan	Springform cake pan	2	True Convection	360 - 375 °F (180 - 190 °C)	35 - 60 min.
Bundt	Bundt cake pan	2	Combination	300 - 320 °F (150 - 160 °C)	35 - 45 min.

Food	Accessories	Level	Oven mode	Temperature	Cooking time
Savory cakes (such as quiche)	Quiche dish	2	True Convection	360 - 375 °F (180 - 190 °C)	35 - 60 min.
Apple tart	Flan base cake pan	2	True Convection	340 - 375 °F (170 - 190 °C)	35 - 50 min.

Sheet Cakes

Food	Accessories	Level	Oven mode	Temperature	Cooking time
Yeast cake	Baking pan	2	Combination	300 - 320 °F (150 - 160 °C)	35 - 45 min.
			True Convection	300 - 320 °F (150 - 160 °C)	35 - 45 min.
Swiss roll	Baking pan	2	True Convection	360 - 390 °F (180 - 200 °C)	10 - 15 min.
Braided loaf	Baking pan	2	Combination	300 - 320 °F (150 - 160 °C)	25 - 35 min.
Strudel, sweet	Baking pan	2	Combination	320 - 360 °F (160 - 180 °C)	40 - 60 min.
Onion tart	Baking pan	2	Combination	340 - 360 °F (170 - 180 °C)	30 - 40 min.

Bread, Bread Rolls

Food	Accessories	Level	Oven mode	Temperature	Cooking time
White bread, 1.7 lbs. (0.75 kg) flour	Baking pan + parchment paper	2	Combination	390 - 410 °F (200 - 210 °C)	15 - 20 min.
			True Convection	320 - 340 °F (160 - 170 °C)	20 - 25 min.
Sourdough bread 1.7 lbs. (0.75 kg) flour	Baking pan + parchment paper	2	Combination	390 - 430 °F (200 - 220 °C)	15 - 25 min.
			True Convection	300 - 320 °F (150 - 160 °C)	40 - 60 min.

Food	Accessories	Level	Oven mode	Temperature	Cooking time
Multigrain bread 1.7 lbs. (0.75 kg) flour	Baking pan + parchment paper	2	Combination	390 - 430°F (200 - 220°C)	15 - 20 min.
			True Convection	320 - 340°F (160 - 170°C)	25 - 40 min.
Whole grain bread 1.7 lbs. (0.75 kg) flour	Baking pan + parchment paper	2	Combination	390 - 430°F (200 - 220°C)	20 - 30 min.
			True Convection	285 - 300°F (140 - 150°C)	40 - 60 min.
Rye bread, 1.7 lbs. (0.75 kg) flour	Baking pan + parchment paper	2	Combination	390 - 430°F (200 - 220°C)	20 - 30 min.
			True Convection	300 - 320°F (150 - 160°C)	50 - 60 min.
Bread rolls, 0.15 lbs. (70 g) each, unbaked	Baking pan + parchment paper	2	Combination	375 - 390°F (190 - 200°C)	25 - 30 min.
Bread rolls made with sweet yeast dough, 0.15 lbs. (70 g) each, unbaked	Baking pan + parchment paper	2	Combination	340 - 360°F (170 - 180°C)	20 - 30 min.

Small Baked Products

Food	Accessories	Level	Oven mode	Temperature	Cooking time
Meringue	Baking pan	2	True Convection	175 - 195°F (80 - 90°C)	120 - 180 min.
Macaroons	Baking pan	2	True Convection	285 - 320°F (140 - 160°C)	15 - 25 min.
Puff pastry	Baking pan	2	Combination	340 - 375°F (170 - 190°C)	10 - 20 min.
Muffins	Muffin pan	2	True Convection	340 - 360°F (170 - 180°C)	20 - 30 min.
Choux pastry, such as cream puffs	Baking pan	2	True Convection	340 - 375°F (170 - 190°C)	27 - 35 min.
Biscuits	Baking pan	2	True Convection	300 - 320°F (150 - 160°C)	12 - 17 min.
Leavened cake, such as apple cake	Baking pan	2	True Convection	300 - 320°F (150 - 160°C)	15 - 20 min.

Baking Tips

If using your own recipe.	Look at cakes or baked goods in the table that are similar to your recipe.
This will help to determine if the cake is cooked through.	About 10 minutes before the end of baking time according to your recipe, stick a toothpick into the highest part of the cake. The cake is done when the batter no longer sticks to the toothpick.
Cake collapses.	Next time, use less liquid or set oven temperature 20 °F (10 °C) lower. Use the mixing times specified in the recipe.
The center of the cake is higher than on the sides.	Do not grease the sides of the springform or cake pan. After baking, carefully remove the cake from the pan using a knife.
Springform or loaf cake is too dark in the back.	Do not place the baking pan up against the back wall of the oven. Place it on the center of the rack.
Cake is too dry.	Use a toothpick to make small holes in the finished cake and pour drops of fruit juice or alcoholic beverage over the cake. Next time, set the temperature 20 °F (10 °C) higher and shorten the baking time or use the Combination oven mode.
The bread or cake looks good, but is runny inside (overly moist, has streaks of liquid running through it).	Next time, use less liquid. Bake a little longer and at a lower temperature. Prebake crusts for pies and cakes with juicy/runny fillings. Sprinkle crust with almonds or bread crumbs and then add the filling. Use the baking time specified in the recipe.
Cakes or baked goods brown unevenly.	Set the temperature a little lower next time.

Reheating Food

Reheat mode gently reheats food. The food tastes and looks as if it were freshly prepared. Baked goods from the day before can also be reheated to their original crispness.

Food	Accessories	Level	Oven mode	Temperature	Cooking time
Dinner plate	Wire rack	2	Reheat	250 °F (120 °C)	12 - 18 min.
Vegetables	Baking pan	3	Reheat	210 °F (100 °C)	12 - 15 min.
Noodles, potatoes, rice	Baking pan	3	Reheat	210 °F (100 °C)	5 - 10 min.
Bread rolls*	Wire rack	2	Combination	340 - 360 °F (170 - 180 °C)	6 - 8 min.
Baguettes*	Wire rack	2	Combination	340 - 360 °F (170 - 180 °C)	5 - 10 min.
Bread*	Wire rack	2	Combination	340 - 360 °F (170 - 180 °C)	8 - 12 min.
Pizza	Wire rack + baking pan	3	Reheat	340 - 360 °F (170 - 180 °C)	12 - 15 min.

* Preheat for 5 minutes

Defrosting

Freeze the food as flat as possible and in appropriate portions at -0 °F (-18 °C). Do not freeze oversized portions. Defrosted food does not keep as long and spoils more quickly than fresh food.

Defrost the food in the freezer bag on a plate or in the perforated cooking pan. Always slide the baking pan under the perforated cooking pan. This keeps the food from lying in the defrosted water and keeps the oven clean.

Use the Defrost mode.

If necessary, while the food is thawing, split it up or take pieces that have already thawed out of the appliance.

Let the food sit for another 5 to 15 minutes after it has thawed to reach room temperature.



WARNING: Health hazard!

When defrosting animal food products, make sure to remove the thawed liquid. The liquid must not come into contact with other food products. Germs could be transferred to the other food.

After the food has thawed, heat up the steamer oven using True Convection for 15 minutes at 360 °F (180 °C.).

Defrosting meat

Thaw cuts of meat that will be breaded just until seasonings and bread crumbs can stick to the meat.

Defrosting poultry

Remove from packaging before defrosting. Make sure to pour out any defrosted liquid.

Food	Amount/ weight	Accessories	Level	Temperature	Cooking time
Chicken parts, bone-in	2 lbs. (1 kg)	Perforated + baking pan	3 1	115 - 120°F (45 - 50°C)	60 - 70 min.
Chicken parts, boneless	1 lbs. (0.4 kg)	Perforated + baking pan	3 1	115 - 120°F (45 - 50°C)	30 - 35 min.
Block-frozen vegetables (such as spinach)	1 lbs. (0.4 kg)	Perforated + baking pan	3 1	115 - 120°F (45 - 50°C)	20 - 30 min.
Berries	0.66 lbs. (0.3 kg)	Perforated + baking pan	3 1	115 - 120°F (45 - 50°C)	5 - 8 min.
Fish fillets	1 lbs. (0.4 kg)	Perforated + baking pan	3 1	115 - 120°F (45 - 50°C)	15 - 20 min.
Beef	–	Perforated + baking pan	3 1	115 - 120°F (45 - 50°C)	70 - 80 min.

Proofing Dough

The dough rises much faster using this mode than at room temperature.

You can choose any rack level for the rack or carefully place the rack on the oven bottom.

Warning: Do not scratch the oven bottom!

Place the dough-rising bowl on the rack. Do not cover the dough.

Food	Amount	Ovenware	Temperature	Cooking time
Yeast dough	2 lbs. (1 kg)	Bowl + wire rack	105 °F (40 °C)	20 - 30 min.
Sourdough	2 lbs. (1 kg)	Bowl + wire rack	105 °F (40 °C)	20 - 30 min.

Juice Extraction

Before extracting juice from berries, place the berries in a bowl and add sugar. Let the berries sit for one hour so that the juice is drawn out.

Place berries in the perforated cooking pan and place pan at rack level 3. To catch the juice, place the non-perforated cooking pan at rack level 1.

When ready, pour the berries into a cheese cloth and squeeze out the remaining juice.

Food	Accessories	Level	Oven mode	Temperature	Cooking time
Raspberries	Perforated + cooking pan	3 1	Steam	210 °F (100 °C)	30 - 45 min.
Red currants	Perforated + cooking pan	3 1	Steam	210 °F (100 °C)	40 - 50 min.

Frozen Products

Follow the manufacturer's instructions on the packaging.

The specified cooking times apply to dishes placed in a cold oven.

Food	Accessories	Level	Oven mode	Temperature	Cooking time
French fries	Baking pan + parchment paper	2	True Convection	340 - 375 °F (170 - 190 °C)	25 - 35 min.
Croquettes	Baking pan + parchment paper	2	True Convection	360 - 390 °F (180 - 200 °C)	18 - 22 min.
Thinly sliced fried potatoes	Baking pan + parchment paper	2	True Convection	360 - 390 °F (180 - 200 °C)	25 - 30 min.
Pasta, fresh, refrigerated*	Baking pan + parchment paper	2	Steam	210 °F (100 °C)	5 - 10 min.
Lasagna, frozen	Baking pan + wire rack	2	Combination	375 - 410 °F (190 - 210 °C)	35 - 55 min.
Pizza, thin crust	Baking pan + wire rack	2	True Convection	360 - 390 °F (180 - 200 °C)	15 - 23 min.
Pizza, deep dish	Baking pan + wire rack	2	True Convection	360 - 390 °F (180 - 200 °C)	18 - 25 min.

* Add a little liquid

Food	Accessories	Level	Oven mode	Temperature	Cooking time
Pizza, French bread	Baking pan + wire rack	2	True Convection	360 - 390°F (180 - 200°C)	18 - 22 min.
Chilled pizza	Baking pan + parchment paper	2	True Convection	340 - 360°F (170 - 180°C)	12 - 17 min.
Herb butter baguettes, refrigerated	Baking pan	2	True Convection	360 - 390°F (180 - 200°C)	15 - 20 min.
Bread rolls, baguettes, frozen	Baking pan + wire rack	2	True Convection	360 - 390°F (180 - 200°C)	18 - 22 min.
Pretzels, frozen	Baking pan + parchment paper	2	True Convection	360 - 390°F (180 - 200°C)	18 - 22 min.
Partially cooked bread rolls or baguettes, pre-baked	Baking pan + parchment paper	2	True Convection	300 - 340°F (150 - 170°C)	12 - 15 min.
Strudel, frozen	Baking pan + parchment paper	2	Combination	320 - 360°F (160 - 180°C)	45 - 60 min.
Fish sticks	Baking pan + parchment paper	2	True Convection	380 - 400°F (195 - 205°C)	20 - 24 min.
Whole fish	Perforated + baking pan	3 1	Steam	175 - 210°F (80 - 100°C)	20 - 25 min.
Frozen fish fillets	Baking pan + wire rack	2	Combination	360 - 390°F (180 - 200°C)	35 - 50 min.
Salmon fillets	Perforated + cooking pan	3 1	Steam	175 - 210°F (80 - 100°C)	20 - 25 min.
Broccoli	Perforated + cooking pan	3 1	Steam	210°F (100°C)	4 - 6 min.
Cauliflower	Perforated + cooking pan	3 1	Steam	210°F (100°C)	5 - 8 min.
Green beans	Perforated + cooking pan	3 1	Steam	210°F (100°C)	4 - 6 min.
Peas	Perforated + cooking pan	3 1	Steam	210°F (100°C)	4 - 6 min.
Carrots	Perforated + cooking pan	3 1	Steam	210°F (100°C)	3 - 5 min.
Mixed vegetables	Perforated + cooking pan	3 1	Steam	210°F (100°C)	4 - 8 min.
Brussels sprouts	Perforated + cooking pan	3 1	Steam	210°F (100°C)	5 - 10 min.

* Add a little liquid

Cleaning and Maintenance

Cleaning

This section covers information on the following:

- Care and cleaning of the appliance
- Cleaning agents and aids
- Steam Clean mode
- Decalcify mode



WARNING: Risk of burns!
Wait until the appliance has cooled down before cleaning.



WARNING: Risk of short circuiting!
Never use pressure washers or steam jet blowers to clean the appliance.



CAUTION: Risk of damage to surfaces! Never use harsh or abrasive cleaning agents, oven cleaners, corrosive, chlorinated or aggressive cleaners. If one of these types of agents comes in contact with the front of the appliance, wipe it off immediately with water.

Remove food residue and spills from the cavity immediately after the appliance has cooled down. Burned on residue is very difficult to remove at a later time.

If heavily soiled, use Steam Clean mode (see Steam Clean).

Salts are very abrasive and can cause rust spots. Remove residue left by strong sauces (ketchup, mustard) or salted foods immediately after the oven has cooled down.

Cleaning Sponge

The cleaning sponge provided is very absorbent. Use the cleaning sponge only to clean the oven cavity and to remove any remaining water from the evaporator dish.

Wash the cleaning sponge thoroughly before initial use. The cleaning sponge can be washed in a dishwasher.

Cleaners

Appliance exterior	Soapy water. Use a soft cloth to dry.
aluminum front panel/handle	Mild window cleaner. Wipe using a soft window cloth or a lint-free microfiber cloth at a horizontal angle without placing pressure on the surfaces.
stainless steel front panel, trim, door handle	Soapy water. Use a soft cloth to dry. Always remove lime deposits, grease, oil, starch and egg white stains immediately. Special stainless steel cleaners are available through customer service or at retail stores.
Oven interior	Warm soapy water or vinegar and water mixture Use the cleaning sponge provided or a soft dishwashing brush. Never use steel wool or abrasive pads! The oven cavity can rust. If heavily soiled, use an all-purpose cleaner, such as Simple Green. Follow package directions for mixing. Spray on soils, allow to work for 15 - 30 minutes, then wipe the entire cavity with paper towels or cloth. Run Steam Clean cycle to so the cavity is rinsed thoroughly. Do not allow the oven light, bulb or door gaskets to come in contact with the cleaner.
Evaporator dish	Warm soapy water or vinegar and water mixture
Outer gasket on oven	Warm soapy water
Water tank	Soapy water. Do not clean in dishwasher!
Tank slot	Wipe dry after each use
Lid seal	Dry well after each use
Rack rails	Use warm soapy water or wash in dishwasher
Glass in doors	Glass cleaner
Accessories	Soak in warm soapy water. Clean with a brush or kitchen sponge or wash in dishwasher. Use a water and vinegar mixture for stains or discoloration caused by starchy foods (such as rice).

Steam Clean

Steam Clean uses steam to help dissolve food residue and spills in the oven. Residue and spills can be easily removed afterward.

Steam Clean takes approximately 30 minutes.

Note:

Operation of the appliance will be blocked if Steam Clean is canceled. The appliance cannot be operated again until after the first and second cleaning cycle to ensure that no dishwashing liquid remains inside.

Preparation

Let the oven cool down and remove any accessories. Clean the evaporator dish using the cleaning sponge provided.

Fill the water tank with water up to “max”. Add a drop of dishwashing liquid to the evaporator dish on the oven bottom.

Starting Steam Clean

1. Press and hold ON/OFF until the appliance turns on.
2. Press STEAM CLEAN to select Steam Clean mode.
3. Press START/STOP.

Steam Clean starts. The light in the oven remains off.

Cleaning Cycle 1

A beep sounds after approximately 30 minutes. The  (empty evaporator dish) symbol appears.

1. Remove the rack rails from the oven and clean (see Removing the Rack Rails).
2. Use a soft dishwashing brush and the cleaning sponge to wipe out the partially dissolved food soil from the oven and evaporator dish.
3. Fill the water tank with water, if necessary, and then slide it back in.
4. Press START/STOP.

The appliance starts the cleaning process.

Cleaning Cycle 2

After a short time, the  symbol appears for the second time.

1. Thoroughly wash out the cleaning sponge.
2. Use the cleaning sponge to remove any water remaining in the evaporator dish.
3. Press START/STOP.

The appliance starts the cleaning process. After the second cleaning cycle, the  symbol appears.

4. Press and hold ON/OFF.

Removing Residual Water

Use the cleaning sponge to remove any water remaining in the evaporator dish. Wipe down the oven using the cleaning sponge and dry afterwards using a soft cloth.

Canceling Steam Clean

1. Press and hold ON/OFF.

Steam Clean stops.

The appliance must be cleaned twice after Steam Clean is canceled to ensure that no dishwashing soap remains inside.

2. Press ON/OFF.

The  symbol appears.

Now follow the same steps as under “Cleaning Cycle 1” described above.

Decalcify

Run Decalcify mode at specific intervals to ensure that the appliance continues to operate properly. The  indicator will remind you.

The descaling process takes approximately 30 minutes.

Decalcify mode is not required if you only use softened water.

Note:

Operation of the appliance will be blocked if Decalcify is canceled. The appliance cannot be operated again until after the first and second cleaning cycle to ensure that no descaling agent remains inside.

Descaling Agent

Use only the powder descaler recommended by customer service to descale the appliance.

USA: item no. 310 967 at www.thermador-eshop.com

Canada: For Atlantic provinces, Ontario or Québec, contact A.P. Wagner, 1-800-287-1627, www.apwagner.ca

For any of the Territories, Manitoba, Saskatchewan, Alberta or British Columbia, contact Reliable Parts, 1-800-941-9217, www.reliableparts.ca

Other descaling agents can damage the appliance.

1. Mix 32 oz water and 1 packet powder descaler to produce a descaler solution.
2. Empty the water tank and fill it with the descaling solution.



CAUTION: Do not let the descaling solution come in contact with the control panel or other sensitive surfaces. If it does, immediately remove it using water.

Starting Decalcify Mode

The oven cavity must be cooled down completely.

1. Press and hold ON/OFF until the appliance turns on.
2. Press DECALCIFY to select Decalcify mode.
3. Press START/STOP.

Decalcify mode starts. The light in the oven remains off.

Cleaning Cycle 1

A beep sounds after approximately 30 minutes. The  (fill water tank) symbol appears.

1. Wash out the water tank thoroughly, fill it with water and slide it back in.

The  (empty evaporator dish) symbol appears.

2. Use the cleaning sponge provided to remove any water remaining in the evaporator dish.
3. Press START/STOP.

The appliance starts the cleaning process.

Cleaning Cycle 2

After a short time, the  symbol appears for the second time.

1. Thoroughly wash out the cleaning sponge.
2. Use the cleaning sponge to remove any water remaining in the evaporator dish.

3. Press START/STOP.

The appliance starts the cleaning process. After Decalcify mode is complete,  appears.

4. Press and hold ON/OFF.

Removing Residual Water

Use the cleaning sponge to remove any water remaining in the evaporator dish. Wipe down the oven using the cleaning sponge and dry afterwards using a soft cloth.

Canceling Decalcify Mode

1. Press and hold ON/OFF.

Decalcify mode stops.

The appliance must be cleaned twice after Decalcify mode is canceled to ensure that no descaling solution remains inside.

2. Press ON/OFF.

The  symbol appears.

Now follow the same steps as under “Cleaning Cycle 1” described above.

Descaling Only the Evaporator Dish

You can also use Decalcify mode to descale only the evaporator dish in the oven cavity without descaling the entire appliance.

The only difference in this procedure is as follows:

1. Mix 1½ cups water and 2 teaspoons powder descaler to produce a descaler solution.
2. Fill the evaporator dish completely with the descaling solution.
3. Fill the water tank with water only.
4. Start Decalcify mode as described.

You can also descale the evaporator dish manually.

Removing and Installing the Appliance Door

The appliance door can be removed for easy cleaning.



WARNING: When removing the door:

- Make sure oven is cool and power to the oven has been turned off before removing the door. Failure to do so could result in electrical shock or burns.
- The oven door is heavy and fragile. Use both hands to remove the oven door. The door front is glass. Handle carefully to avoid breaking.
- Grasp only the sides of the oven door. Do not grasp the handle, since it may swing in your hand and cause damage or injury.
- Failure to grasp the oven door firmly and properly could result in personal injury or product damage.
- To avoid injury from hinge bracket snapping closed, be sure that both levers are securely in place before removing the door. Also, do not force door open or closed – this could damage the hinge, potentially causing an injury.
- If the door is removed without turning both retainers until they stop, the hinge can snap back. Do not reach into the hinge area. Call customer service.
- Lay the door on a flat smooth surface so that the door cannot fall over. Failure to do so may result in personal injury or damage to the appliance.

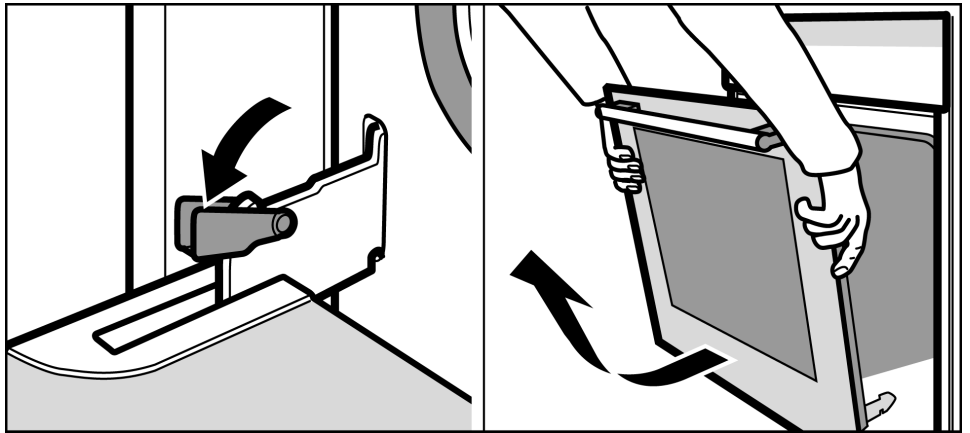

1. Open the door all the way.
2. Lay the two stop levers on the right and left down flat.
3. Position the door at an angle.
Use both hands to grasp the left and right sides of the door. Close the door a little more and then remove it.

Installing the Door

Reattach the door after cleaning.

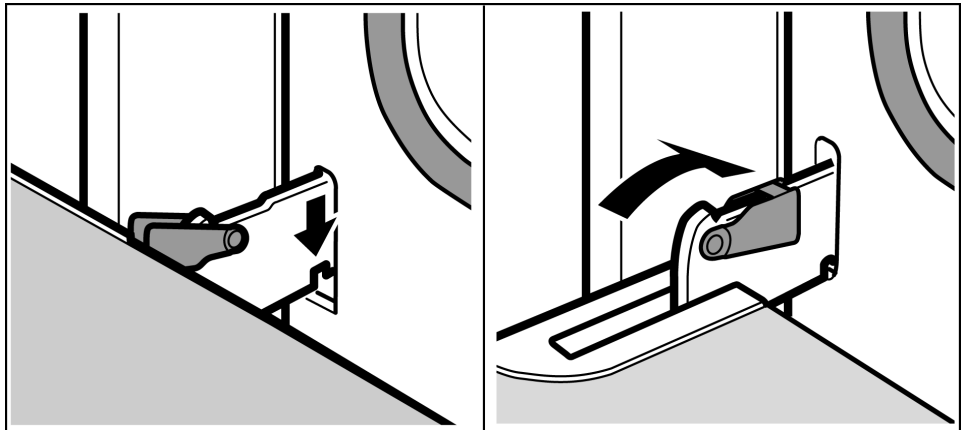

1. Keep the door hinges straight while inserting them into the left and right oven openings. The notch on both hinges must lock in place on both sides.
2. Open the door all the way and flip up the stop lever.
3. Close the door.

Cleaning the Rack Rail Frames

The rack rail frames can be removed for cleaning.

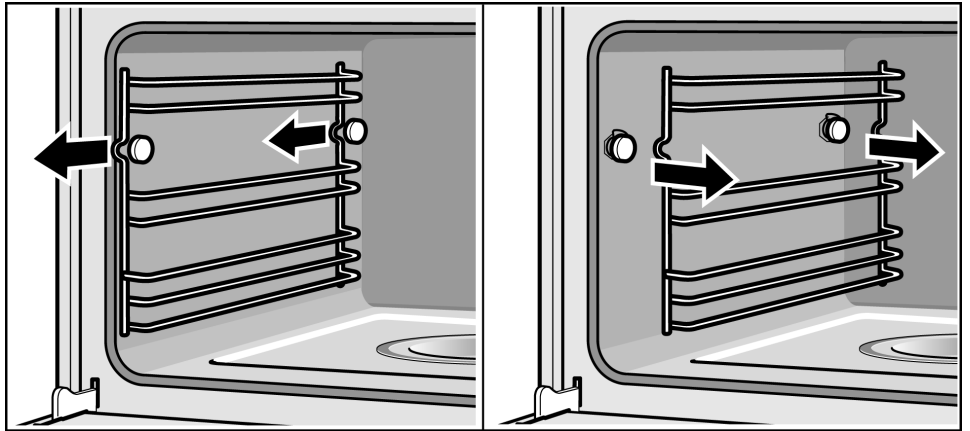

Pull the rack rail frame toward you and remove.

Use dishwashing soap and a kitchen sponge or brush to clean the rack rail frames. The rack rail frames can also be washed in the dishwasher.

Installing the Rack Rail Frames

Hang the back and front parts of the frame and then push it back until it locks into place.

Each rack rail frame only fits on one side.

Cleaning the Door Glass

The inner door glass on the appliance can be removed for easier cleaning.



WARNING: Do not use the appliance until the door glass and appliance door have been properly installed.

1. Remove the door and place it on a towel, handle side down.

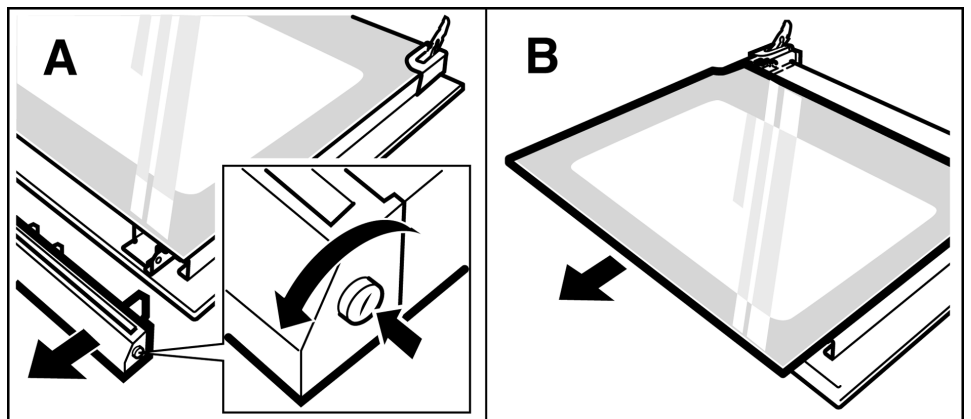

2. Unscrew the top cover on the door. To do this, loosen the left and right screws. (Fig. A)

3. Remove the door glass. (Fig. B)

Clean the door glass using a glass cleaner and a soft cloth.

Installing the Door Glass

1. Reinsert the door glass.
Make sure that the flat surface faces outward and the printed surface is on the inside.
2. Put the cover in place and screw it back on.
3. Reinstall the door.

Maintenance

Replacing the Oven Bulb

Heat-resistant 230V / 25 Watt halogen bulbs with seals can be purchased through retail stores or customer service. If purchasing through customer service provide the appliance model and serial numbers.



WARNING:

- Make sure the appliance and lights are cool and power to the appliance has been turned off before replacing the light bulb(s). Failure to do so could result in electrical shock or burns.
- The covers must be in place when using the appliance.
- The covers serve to protect the light bulb from breaking.
- The covers are made of glass. Handle carefully to avoid breaking. Broken glass could cause an injury.
- The light socket is live when the door is open.

Always use a dry cloth to remove the halogen bulb from its packaging, otherwise the life of the bulb will be shortened.

1. Turn off power to the appliance at the main power supply (fuse or breaker box) or unplug the power cord.
2. Turn the cover to the left to remove.
3. Remove the bulb and replace with the same type of bulb.
4. Slip the new seals and tension ring onto the glass cover.

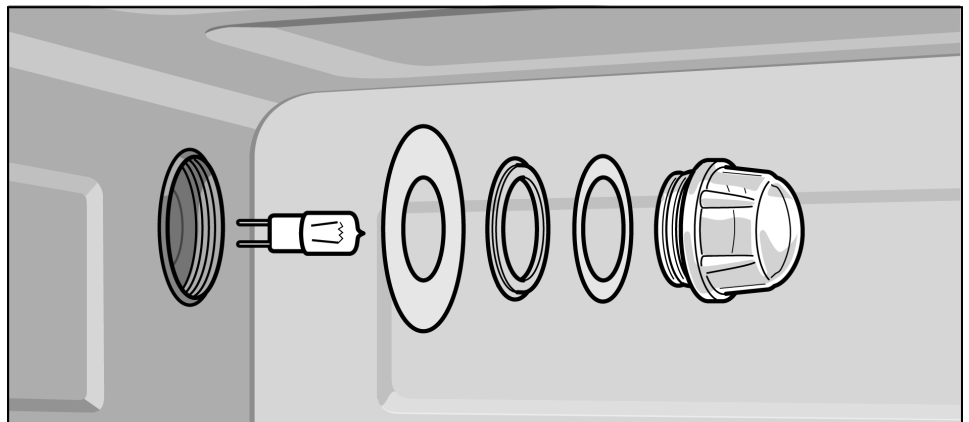

5. Screw the glass cover with seals back on.
6. Reconnect the appliance to power and reset the clock.

Never operate the appliance without the glass cover or seals.

Replacing the Glass Cover or Seals

Damaged glass covers or seals must be replaced. Provide customer service with the appliance model and serial numbers.

Replacing the Door Gasket

If the outer gasket on the oven door is defective, it must be replaced. Replacement gaskets for the appliance can be obtained through customer service. Provide customer service with the appliance model and serial numbers.

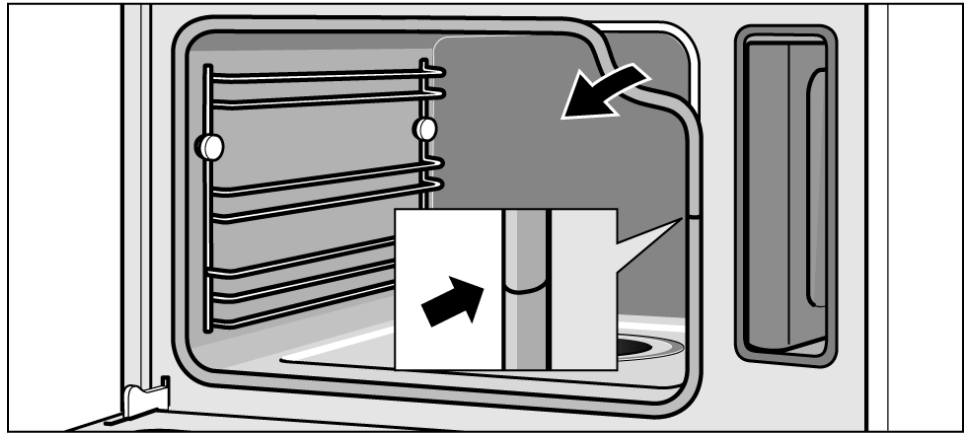

1. Open the appliance door.
2. Remove the old door gasket.
3. Insert the new door gasket and tuck it in all the way around the door. The seam must be on the side of the door.
4. Check the fit of the door gasket again, particularly in the corners.



Service

Before Calling Service

If a problem occurs, it is usually just minor. Read the following information before calling customer service.

Repairs must be made by trained customer service technicians only. Improper repairs made to the appliance can place you at extreme risk.

Problem	Possible cause	Tip / Solution
Appliance is not working	Cord is not plugged in	Connect appliance to power
	Power outage	Check if other kitchen appliances are working
	Defective fuse	Check the fuse or breaker box to see if the breaker or fuse to the appliance is working
	Faulty operation	Turn off power to the appliance at the main power supply (fuse or breaker box) and turn it back on after approximately 10 seconds
Appliance does not start	Appliance door is not closed all the way	Close the door
Appliance does not start, 00:40 min. appears and  flashes in the display	Steam Clean or Decalcify was canceled	Clean the appliance twice (see Canceling Steam Clean or Canceling Decalcify Mode)
Four zeros appear in the display 00:00	Power outage	Set the current time using the settings dial and then press TIMER/CLOCK
Appliance is not operating. A cook time appears in the display	The settings dial was turned accidentally	Press START/STOP
	After adjusting the setting, START/STOP was not pressed	Press START/STOP, or clear the setting by pressing ON/OFF
Appliance is not heating up. Three heat indicator bars appear in the display	A touchpad combination was pressed	Disconnect from power and reconnect after approximately 20 seconds. Within 2 minutes, press and hold PANEL LOCK for 4 seconds
FB appears in the display	Automatic shutoff is activated	Press any touchpad
 appears	Appliance has not been used for at least 2 days and the water tank is full	Empty and clean the water tank. Always empty the water tank after cooking
The  indicator appears, but the water tank is full	Water tank was not inserted correctly	Slide in water tank until it locks in place
	Detection system not working	Call customer service

Problem	Possible cause	Tip / Solution
The  indicator appears, but the water tank is not empty yet, or the water tank is empty, but the  indicator does not appear	Water tank is dirty. The moving water level detectors are stuck	Shake and clean the water tank. If the components are still stuck, obtain a new water tank through customer service
Water tank empties without any apparent reason. Evaporator dish is overflowing	Water tank was not closed properly	Close the tank lid until it clearly snaps into place
	Tank lid seal is dirty	Clean the seal
	Tank lid seal is defective	Obtain a new water tank through customer service
Evaporator dish has been boiled dry even though the water tank is full	Water tank was not inserted correctly	Slide in the water tank until it locks into place
	Supply line is clogged	Descale appliance. Verify that the water hardness level is set correctly
A "plop" noise can be heard when cooking	Temperature change affecting frozen food and caused by water vapor	This is normal
An excessive amount of steam is produced when steaming	Appliance is being calibrated automatically	This is normal
An excessive amount of steam is repeatedly produced when steaming	Appliance cannot be calibrated automatically when cooking for short periods of time	Reset the appliance to the factory setting (see Basic Settings). Next, start the Steam mode for 20 minutes at 210°F (100°C)
Steam escapes from the vent openings when cooking		This is normal
Appliance no longer produces steam correctly	The appliance needs to be descaled	Start Decalcify mode
The error message "E..." appears in the display	Technical defect	Turn the settings dial to clear the error message and reset the clock, if necessary. If the error message reappears, contact customer service
The error message "E011" appears in the display	A touchpad was pressed for too long or is stuck	Turn the settings dial to clear the error message. Press all touchpads individually to check if they are clean

Customer Service

If the appliance needs to be repaired, customer service can assist you. To reach a service representative, contact 1-800-735-4328 or www.thermador.com.

Model and Serial Numbers

Always provide customer service with the model number (E no.) and serial number (FD no.) of your appliance. The data plate with the numbers is located on the bottom left side when you open the oven door. To ensure that you can easily find the numbers in the event of a malfunction, write down the appliance information here.

Model no.	Serial no.
-----------	------------

Customer Service 🏠

Energy-Saving Tips

Only preheat the appliance if specified in the recipe or in the tables and charts in this manual.

Keep the appliance door closed as much as possible during the cooking process.

Baking

Use dark, black-coated or enamel baking dishes. They absorb heat well.

It is best to bake several cakes one after the other. The combination oven is still warm, which shortens the baking time for the second cake. You can also place two loaf pans side by side.

When baking for longer periods of time, you can turn the combination oven off 10 minutes early and use the residual heat to finish baking the food.

Steaming

Food can be placed on multiple rack levels to steam cook at the same time.

For foods with different cooking times, place the food with the longest cooking time in the oven first.

STATEMENT OF LIMITED PRODUCT WARRANTY



What this Warranty Covers & Who it Applies to

The limited warranty provided by BSH Home Appliances Thermador in this Statement of Limited Product Warranty applies only to the Thermador appliance sold to you, the first using purchaser, provided that the Product was purchased:

- For your normal, household (non-commercial) use, and has in fact at all times only been used for normal household purposes.
- New at retail (not a display, “as is”, or previously returned model), and not for resale, or commercial use.
- Within the United States or Canada, and has at all times remained within the country of original purchase.

The warranties stated herein apply only to the first purchaser of the Product and are not transferable.

Please make sure to return your registration card; while not necessary to effectuate warranty coverage, it is the best way for Thermador to notify you in the unlikely event of a safety notice or product recall.

How Long the Warranty Lasts

Thermador warrants that the Product is free from defects in materials and workmanship for a period of twelve (12) months from the date of purchase. The foregoing timeline begins to run upon the date of purchase, and shall not be stalled, tolled, extended, or suspended, for any reason whatsoever.

Repair/Replace as Your Exclusive Remedy

During this warranty period, Thermador or one of its authorized service providers will repair your Product without charge to you (subject to certain limitations stated herein) if your Product proves to have been manufactured with a defect in materials or workmanship. If reasonable attempts to repair the Product have been made without success, then Thermador will replace your Product (upgraded models may be available to you, in Thermador’s sole discretion, for an additional charge). All removed parts and components shall become the property of Thermador at its sole option. All replaced and/or repaired parts shall assume the identity of the original part for purposes of this warranty and this warranty shall not be extended with respect to such parts. Thermador’s sole liability and responsibility hereunder is to repair manufacturer-defective Product only, using a Thermador-authorized service provider during normal business hours. For safety and property damage concerns, Thermador highly recommends that you do not attempt to repair the Product yourself, or use an un-authorized servicer; Thermador will have no responsibility or liability for repairs or work performed by a non-authorized servicer. If you choose to have someone other than an authorized service provider work on your Product, THIS WARRANTY WILL AUTOMATICALLY BECOME NULL AND VOID. Authorized service providers are those persons or companies that have been specially trained on Thermador products, and who possess, in Thermador’s opinion, a superior reputation for customer service and technical ability (note that they are independent entities and are *not* agents, partners, affiliates or representatives of Thermador). Notwithstanding the foregoing, Thermador will not incur any liability, or have responsibility, for the Product if it is located in a remote area (more than 100 miles from an authorized service provider) or is reasonably inaccessible, hazardous, threatening, or treacherous locale, surroundings, or environment; in any such event, if you request, Thermador would still pay for labor and parts and ship the parts to

the nearest authorized service provider, but you would still be fully liable and responsible for any travel time or other special charges by the service company, assuming they agree to make the service call.

Out of Warranty Product

Thermador is under no obligation, at law or otherwise, to provide you with any concessions, including repairs, pro-rates, or Product replacement, once this warranty has expired.

Warranty Exclusions

The warranty coverage described herein excludes all defects or damage that are not the direct fault of Thermador, including without limitation, one or more of the following:

- Use of the Product in anything other than its normal, customary and intended manner (including without limitation, any form of commercial use, use or storage of an indoor product outdoors, use of the Product in conjunction with air or water-going vessels).
- Any party's willful misconduct, negligence, misuse, abuse, accidents, neglect, improper operation, failure to maintain, improper or negligent installation, tampering, failure to follow operating instructions, mishandling, unauthorized service (including self-performed "fixing" or exploration of the appliance's internal workings).
- Adjustment, alteration or modification of any kind.
- A failure to comply with any applicable state, local, city, or county electrical, plumbing and/or building codes, regulations, or laws, including failure to install the product in strict conformity with local fire and building codes and regulations.
- Ordinary wear and tear, spills of food, liquid, grease accumulations, or other substances that accumulate on, in, or around the Product.
- Any external, elemental and/or environmental forces and factors, including without limitation, rain, wind, sand, floods, fires, mud slides, freezing temperatures, excessive moisture or extended exposure to humidity, lightning, power surges, structural failures surrounding the appliance, and acts of God.

In no event shall Thermador have any liability or responsibility whatsoever for damage to surrounding property, including cabinetry, floors, ceilings, and other structures or objects around the Product. Also excluded from this warranty are scratches, nicks, minor dents, and cosmetic damages on external surfaces and exposed parts; Products on which the serial numbers have been altered, defaced, or removed; service visits to teach you how to use the Product, or visits where there is nothing wrong with the Product; correction of installation problems (you are solely responsible for any structure and setting for the Product, including all electrical, plumbing or other connecting facilities, for proper foundation/flooring, and for any alterations including without limitation cabinetry, walls, floors, shelving, etc.); and resetting of breakers or fuses.

TO THE EXTENT ALLOWED BY LAW, THIS WARRANTY SETS OUT YOUR EXCLUSIVE REMEDIES WITH RESPECT TO PRODUCT, WHETHER THE CLAIM ARISES IN CONTRACT OR TORT (INCLUDING STRICT LIABILITY, OR NEGLIGENCE) OR OTHERWISE. THIS WARRANTY IS IN LIEU OF ALL OTHER WARRANTIES, WHETHER EXPRESS OR IMPLIED. ANY WARRANTY IMPLIED BY LAW, WHETHER FOR MERCHANTABILITY OR FITNESS FOR A PARTICULAR PURPOSE, OR OTHERWISE, SHALL BE EFFECTIVE ONLY FOR THE PERIOD THAT THIS EXPRESS LIMITED WARRANTY IS EFFECTIVE. IN NO EVENT WILL THE MANUFACTURER BE LIABLE FOR CONSEQUENTIAL, SPECIAL, INCIDENTAL, INDIRECT, "BUSINESS LOSS",

AND/OR PUNITIVE DAMAGES, LOSSES, OR EXPENSES, INCLUDING WITHOUT LIMITATION TIME AWAY FROM WORK, HOTELS AND/OR RESTAURANT MEALS, REMODELLING EXPENSES IN EXCESS OF DIRECT DAMAGES WHICH ARE DEFINITELY CAUSED EXCLUSIVELY BY THERMADOR, OR OTHERWISE. SOME STATES DO NOT ALLOW THE EXCLUSION OR LIMITATION OF INCIDENTAL OR CONSEQUENTIAL DAMAGES, AND SOME STATES DO NOT ALLOW LIMITATIONS ON HOW LONG AN IMPLIED WARRANTY LASTS, SO THE ABOVE LIMITATIONS MAY NOT APPLY TO YOU. THIS WARRANTY GIVES YOU SPECIFIC LEGAL RIGHTS, AND YOU MAY ALSO HAVE OTHER RIGHTS WHICH VARY FROM STATE TO STATE.

No attempt to alter, modify or amend this warranty shall be effective unless authorized in writing by an officer of BSH.

Thermador[®]