



PRO+™



180 Years of Range Innovation

PRO+™

The modern kitchen is a multifunctional space where cooking, eating, entertaining and relaxing unites family and friends in one social space that is both practical and stylish.

The latest suite from AGA embraces the hottest kitchen trends, representing cutting-edge kitchen technology with inspirational ideas and solutions to help make the kitchen the natural hub of any home.





THE WORLD'S MOST VERSATILE 36" SELF-CLEAN PRO RANGE

With energy saving and flexibility at the forefront of its development, AGA is proud to introduce the revolutionary PRO+™.

At the heart of the unique PRO+™ is an internationally patented Energy Saving Panel (ESP) which splits the oven cavity in two - offering you the choice of either a hefty 4.9 cu.ft. of cooking space or an everyday 2.4 cu.ft. oven. Flexible for your changing needs, this modern range is loaded with rich features and energy saving benefits. It is the perfect match for the environmentally conscious and avid chef.



PRO+™ DESIGNER COLORS & STAINLESS STEEL



Black



Cranberry



Ivory



White



Stainless Steel

Our designer colors are available on our entire suite of PRO+™ products



PRO+™ RANGE FEATURES

- Family sized 4.9 cu.ft. oven easily converts to 2.4 cu.ft. oven for your everyday needs
- Self-Clean oven
- Multifunction oven offers Thaw & Serve, Convection Oven, Convection Broiling, Fan-Assisted Oven, Conventional Oven, Browning Element and Warming in both full oven and divided mode
- Large, single, triple-glazed door for easy viewing and reduced kitchen temperatures
- 5 burners each fitted with electronic ignition and a flame safety device, if the flame is accidentally extinguished, the flow of gas will automatically shut off
- Storage drawer large enough to fit Energy Saving Panel (ESP) and all the oven racks when not in use
- Sabbath mode
- 2 full width chrome plated oven racks and 1 full width repositionable telescopic gliding rack provided for 4.9 cu.ft. oven mode
- 3 half width chrome plated oven racks provided for 2.4 cu.ft. oven mode
- Optional Griddle and Wok Ring accessories available (*See page 17*)
- Available in 4 PRO+™ designer colors (black side panels) and stainless steel



REASONS TO CONSIDER THE PRO+™



OUTSTANDING CAPACITY

In full-oven mode, the PRO+™ delivers an impressive 4.9 cu.ft. of capacity - making it one of the largest ovens on the market. With twin fans to ensure even cooking throughout, there is plenty of room to cook those special meals for family and friends on those festive occasions.



TOTAL EASE OF USE

The easy to use full width *telescopic gliding rack* can be positioned in any of the top 5 rack positions in the full oven. It smoothly glides back and forth, making it easy and convenient to pull out those heavy roasts for basting.



TOTAL FLEXIBILITY

Designed to be easy to use and store, the *Energy Saving Panel (ESP)* has been developed to offer total flexibility. When in place, the *ESP* automatically switches the full 4.9 cu.ft oven to compact mode, creating a fully functioning 2.4 cu.ft. everyday oven with 7 cooking functions.



ABSOLUTE SIMMERING CONTROL

Lovers of sweets and sauces will be thrilled with the *simmer* feature on our PRO+™ burners. This allows you to melt chocolate and simmer delicate sauces at temperatures ranging from 140°F/60°C - 160°F/71°C.



SUPER ENERGY SAVINGS

When the family sized oven is more than required for your everyday cooking needs - the *ESP* can be easily set in position to create a fully functioning 2.4 cu.ft. oven. By using half of the space for cooking smaller dishes, heat is directed and distributed more effectively throughout the smaller cooking oven cavity. The other half, although not generating direct heat, is warmed by residual heat ideal for warming plates and food. With energy consumption being a prime concern, the *ESP* is ideal - requiring less energy to run than the full oven, consequently reducing energy consumption by up to 30%.



DUAL EFFICIENCY

The PRO+™ range has the flexibility and versatility of being a dual fuel range. With its powerful gas burners and multifunction electric oven, you have everything you need to cook incredible meals for family and friends. The gas burners, available in natural gas or liquid propane, range in strength from 5,000 to an outstanding 15,000 BTU's. The electric oven has multiple cooking settings and an ingenious *ESP* for dividing the oven cavity and saving energy.

MULTIFUNCTION SETTINGS FOR ANY DAY COOKING

“When cooking for those special occasions, I used to have to plan out my cooking schedule... problem solved with this large oven.”

 **CONVECTION OVEN**
Fan and the heating element around it.

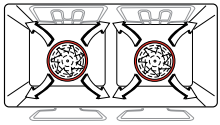

Bake delicious, evenly cooked pizzas with the Convection Oven setting.



SELF-CLEAN

Let the oven do the cleaning for you with the Self-Clean setting.



 **FAN ASSISTED OVEN**
Fan plus outer element at the top and base element.

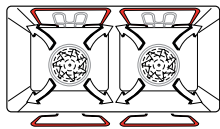

Roast a chicken to succulent, golden brown perfection using the Fan Assisted Oven setting.



 **CONVECTION BROILING**
Fan plus both the top elements.

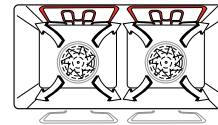

Broil steaks to juicy tender using the Convection Broiling setting.



 **THAW & SERVE**
Fan only. No heat is applied.

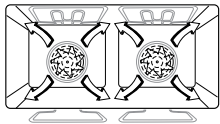

Thaw frozen desserts just in time using the Thaw & Serve setting.



 **CONVENTIONAL OVEN**
Outer top element and the base element - no fan.

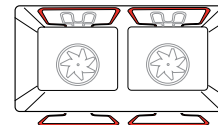

Cook traditional family recipes just like Grandma - using the Conventional Oven setting



 **BROWNING ELEMENT**
Inner element in the top of the oven only.



Lightly brown lasagnas and cannelloni just right with the Browning Element setting.



 **WARMING**
Base element for warming only.

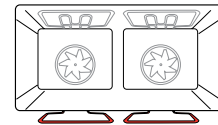

Ahead of schedule with your cooking? Keep food warm until you are ready to serve using the Warming setting.



STATE-OF-THE ART DESIGN FRENCH DOOR REFRIGERATOR

The PRO+™ state-of-the-art French door refrigerator has a multitude of stunning features you will love. A built-in filtered water dispenser, ice maker and electronic touch controls are just a few of the amazing offerings. Keep your fruits and vegetables fresh, crisp and ready to eat with the large, humidity controlled crisper drawers. The extra large deli drawer allows plenty of space for all your meats and cheeses. The adjustable interior and door shelves make storage of all your favorite items easy and convenient.

Keeping with the sleek design, the water dispenser has been discreetly located inside the fridge. This internal filtered water system, with easy to use push button control, guarantees pure refreshment whenever you want it.

The extra large 5.4 cu.ft. capacity freezer will be able to store all the frozen foods you need. Go ahead and stock up on those meats and vegetables - just be sure to make room for the ice cream.

The internal ice cube maker is conveniently located in the freezer. Simplifying your busy schedule by ensuring you always have fresh ice when guests drop by. By filtering the water through the water filter your guests get clearer, better tasting ice - allowing them to further enjoy their drink at its purest in good company.





PRO+™ REFRIGERATOR FEATURES

- French door design
- Refrigerator capacity: 14.4 cu.ft.
- Freezer capacity: 5.4 cu.ft.
- Electronic touch controls
- Built-in filtered water dispenser (includes 1 filter)
- Ice maker conveniently located in freezer
- Humidity controlled crispers
- Temperature controlled deli drawer
- 2 clear gallon door storage shelves
- ENERGY STAR compliant
- Available in 4 PRO+™ designer colors and stainless steel (black side panels)



QUIET RUNNING AND BEAUTIFULLY-CRAFTED INTEGRATED DISHWASHER

The PRO+™ integrated dishwasher features quiet sound insulation technology. It is intuitive, expedient and has a beautifully-crafted matching colored panel to make it the perfect finishing touch. With these endearing attributes, this dishwasher is the smart choice for your PRO+™ kitchen.

The PRO+™ racks feature room for 14 place settings, a dedicated cutlery rack, and a mesh bag for tiny items; you will find this dishwasher extremely handy after meal times and especially the big ones.

Control settings like ProScrub, Quick Clean Up, Hi Temp Scrub and Rinse allow you to have the peace of mind knowing you are conserving energy and water by using what you need while still being assured you have the power for those extra dirty dishes.





PRO+™ DISHWASHER FEATURES

- Durable stainless steel tall tub
- 5 cycles include Heavy Duty, Normal Wash, Light/China, Quick Clean Up and Rinse Only
- 6 options include Pro Scrub, Hi Temp Scrub, Sani Rinse, Heat Dry, 4 Hour Delay and Control Lock
- Culinary tool rack provides a dedicated area for hard-to-place items
- Quiet sound insulation technology, rated to 50 dBA
- 4-blade food disposer eliminates the need for pre-rinsing
- Holds up to 14 place settings
- Unique settings deliver superior concentrated cleaning performance
- Optimum wash sensor adjusts the wash cycle to specific water conditions
- ENERGY STAR compliant
- Available in 4 PRO+™ designer colors and stainless steel



SLEEK AND STYLISH FUNCTIONALITY FROM TOP TO BOTTOM

PRO+™ VENT HOOD

This high powered, sleek PRO+™ 36" vent hood adds functionality and style to your kitchen. The 3-speed fan ensures the right amount of airflow to clear your kitchen of any unpleasant odors or smoke. The quick touch controls and high quality stainless steel baffle filters assure that your cooking experience is a simple and safe one.

PRO+™ BACKSPLASH

Protect your walls from splatter and add some flair to your range with a stylish PRO+™ backsplash. Available in 4 PRO+™ colors and stainless steel, this backsplash perfectly matches your PRO+™ range and will be a wonderful accent to your kitchen.





PRO+™ VENT HOOD FEATURES

- Sleek design complements the PRO+™ range
- 3 speed fan
- 600 CFM
- Stainless steel baffle filters fit in most dishwashers for easy clean-up
- 2 halogen lights on underside of hood
- Adjustable duct cover from 19" to 38 1/4" (48.3 cm - 97.2 cm)
- Complementing backsplash available as an optional accessory (*See page 17*)
- Available in 4 PRO+™ designer colors and stainless steel



PRO+™ UNDERCOUNTER REFRIGERATION FEATURES



PRO+™ WINE CELLAR

- Exclusive MicroSentry™ monitor
- Inclined display rack showcases wine bottles, with additional storage in the back
- Dual-pane, tinted, UV-resistant glass door protects contents from damaging UV rays
- Wine racks extend smoothly, with built-in safety stops, to hold all types of wine bottles
- Maple trim on racks is perfect for custom finishing
- Accommodates up to 45 bottles, including magnums
- Black cabinet, framed glass door available in 4 PRO+™ designer colors and stainless steel trim



PRO+™ BEVERAGE CENTER

- Exclusive MicroSentry™ monitor
- Temperature range suitable for wine storage and beverage refrigeration
- Dual-pane, tinted, UV-resistant glass door protects contents from damaging UV rays
- Exclusive half-shelf stores cans and leaves room to vertically store 2-liter and opened wine bottles
- Maple trim on shelves and racks is perfect for custom finishing
- Accommodates up to 14 wine bottles, including magnums and 103 12-oz. canned beverages
- Black cabinet, framed glass door available in 4 PRO+™ designer colors and stainless steel trim



PRO+™ REFRIGERATED DRAWERS

- Exclusive Sentry System™ refrigeration monitor
- White drawer interiors are ideal for fresh food storage
- Extra-deep lower drawer vertically stores 2-liter and wine bottles
- Full extension drawer slides provide easy access
- LED light system provides clean, bright interior lighting
- Black cabinet, drawer fronts available in 4 PRO+™ designer colors and stainless steel

Optional accessories available (See page 17)



PRO+™ SERIES SPECIFICATIONS

The specifications in this brochure are for reference only. Changes to the product may have occurred from the time this brochure was printed. Please obtain a current installation manual for your purchased model before beginning installation, cut-outs or rough-ins. Local authorities govern installation codes. In most areas, a licensed gas fitter or plumber is required.



PRO+™ RANGE

Model:	APRO36DF
Width:	35 1/2" (90.2 cm)
Height:	36 - 37" (91.4 - 94.0 cm)
Depth:	26" (66.0 cm)
Burner Ratings:	(NG) 2 x 9,200 BTU, 1 x 5,000 BTU, 1 x 12,000 BTU, 1 x 15,000 BTU (LP) 2 x 8,000 BTU, 1 x 4,200 BTU, 1 x 12,000 BTU, 1 x 15,000 BTU
Max. Electrical Load:	240 V, 3.85 kW, 16 amps
Oven Capacity:	Full size - 4.9 cu.ft. Half size - 2.4 cu.ft.
Fuel Options:	Natural Gas or Liquid Propane
Features:	<ul style="list-style-type: none"> • 5 burners • Self-Clean • Energy Saving Panel • 7-Mode multifunction oven • 2 full width chrome plated oven racks and 1 full width chrome plated repositionable telescopic gliding rack provided for 4.9 cu. ft. oven mode • 3 half width chrome plated oven racks provided for 2.4 cu. ft. oven mode • Full width storage drawer • Sabbath mode • Optional Griddle and Wok Ring accessories available (See page 17) • Available in 4 PRO+™ designer colors (black side panels) and stainless steel



PRO+™ REFRIGERATOR

Model:	APRO36FD
Width:	36" (91.4 cm)
Height:	69 3/4" (177.2 cm) minimum
Depth:	26 3/8" (67.0 cm)
Capacity:	19.8 cu.ft. total 14.4 cu.ft. refrigerator 5.4 cu.ft. freezer
Electrical Requirements:	115 V, 60 Hz (on a separate 15 amp circuit)
Plumbing Requirements:	1/4" copper tubing
Features:	<ul style="list-style-type: none"> • 4 adjustable glass shelves • 2 adjustable clear door shelves • 2 clear gallon door storage shelves • 2 humidity controlled sealed fruit and vegetable drawers • Temperature controlled pantry drawer • Dairy center and pop can dispenser • Sliding upper and lower freezer baskets with food organizers • Ice maker conveniently located in the freezer • Internal filtered water dispenser • ENERGY STAR compliant • Available in 4 PRO+™ designer colors and stainless steel (black side panels)





PRO+™ DISHWASHER

Model: APRODW
 Width: 23 3/4" (60.3 cm)
 Height: 33 7/8" (86.0 cm)
 Depth: 24 7/8" (63.2 cm)

Electrical Requirements: 120 V, 60 Hz, 12 amps - 1,360 W

- Integrated Dishwasher Features:
- Durable stainless steel tall tub
 - 5 cycles and 6 options
 - Culinary tool rack
 - 4-blade food disposer
 - Adjustable upper rack
 - Holds up to 14 place settings
 - ENERGY STAR compliant
 - Available in 4 PRO+™ designer colors and stainless steel



PRO+™ VENT HOOD

Model: APRO36HD
 Width: Vent Hood: 35 3/8" (90.0 cm)
 Duct Cover: 10 3/8" (26.4 cm)
 Height: Vent Hood: 4 5/8" (11.7 cm)
 Duct Cover: 19" (48.3 cm)
 Duct Cover Extension: 20 1/2" (52.1 cm)
 Total of Hood + Duct Cover: 23 5/8" (60.0 cm)
 Total of Hood + Duct Cover w/Extension: 42 3/4" (108.6 cm)
 Depth: Vent Hood: 19 5/8" (50.0 cm)
 Duct Cover: 10 1/4" (26.0 cm)

Electrical Requirements: 120 V, 3.5 amps

- Features:
- Adjustable duct cover from 19" (48.3 cm) (without extension) to 38 1/4" (97.2 cm) (with included extension)
 - 600 CFM (available in 280 CFM)
 - Stainless steel baffle filters
 - Available in 4 PRO+™ designer colors and stainless steel

Optional: Duct cover extension increases overall height from bottom of hood to top of duct cover to 60" (152.4 cm). Part # APRO38HDEXT-(color)

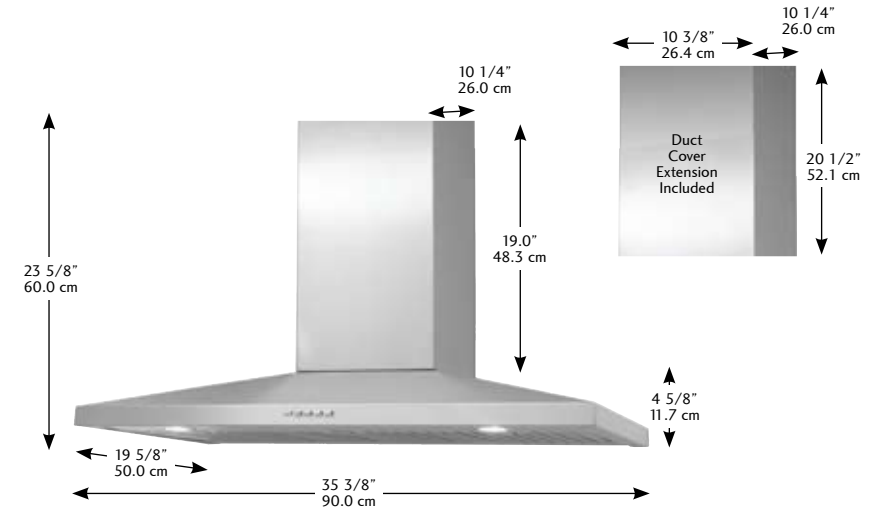

AVAILABLE PRO+™ ACCESSORIES



PRO+™ Griddle
Cast Iron
AG-P028773



PRO+™ Wok Ring
Stainless Steel
3389



PRO+™ 35 1/2" x 35 1/2" Backsplash
Available in 4 PRO+™ designer colors
and stainless steel
APRO36SB



PRO+™ Wine Cellar
Humidrawer™
42242728



PRO+™ Refrigerated Drawers
E-Z Stor System
Upper/Lower 42245441



PRO+™ Refrigerated Drawers
Upper Drawer Divider
42245444



PRO+™ Refrigerated Drawers
Lower Drawer Divider
42245445

PRO+™ UNDERCOUNTER REFRIGERATION SYSTEMS



The MicroSentry™ monitor controls the refrigeration system's performance to maintain a constant and precise temperature. A visual and audible alarm signals if the temperature goes above or below the set point for a period of time which may impact storage quality or if a door is left ajar. A discreet amber LED display shows content temperature in real time. The digital touch controls provide an easy interface to select the desired temperature for perfect wine storage. Interior light can be set for continuous display.



The exclusive Sentry System™ refrigeration monitor operates in real time to actively maintain optimal preservation conditions. Many systems monitor cabinet air temperature and cycle on and off to meet the set point, creating a volatile environment. Our system uses intuitive controls to predict temperature based on demand. As a result, it engages the cooling system to make adjustments in temperature, creating a more stable environment.

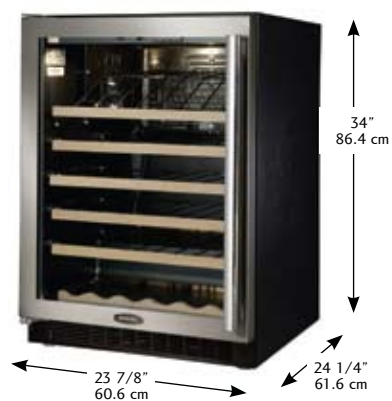

PRO+™ WINE CELLAR

Model:	APRO61 WCM
Width:	23 7/8" (60.6 cm)
Height:	34" (86.4 cm)
Depth:	24 1/4" (61.6 cm)
Electrical Requirements:	115 V, 60 Hz (on a separate 15 amp circuit)
Features:	<ul style="list-style-type: none"> • Exclusive MicroSentry™ monitor • Inclined display rack • Dual-pane, tinted, UV-resistant glass • Wine racks with built-in safety stops • Maple trim on racks • Signature ebony interior • Accommodates up to 45 bottles • Black cabinet, framed glass door available in all 4 PRO+™ designer colors and stainless steel trim • Optional Humidrawer™ accessory available (See page 17)



PRO+™ BEVERAGE CENTER

Model:	APRO6BARM
Width:	23 7/8" (60.6 cm)
Height:	34" (86.4 cm)
Depth:	24 1/4" (61.6 cm)
Electrical Requirements:	115 V, 60 Hz (on a separate 15 amp circuit)
Features:	<ul style="list-style-type: none"> • Temperature range suitable for wine storage and beverage refrigeration • Exclusive MicroSentry™ monitor • Dual-pane, tinted, UV-resistant glass door • Exclusive half-shelf • Maple trim on shelves and racks • Signature ebony interior • Accommodates up to 14 wine bottles and 103 12-oz. canned beverages • Black cabinet, framed glass door available in all 4 PRO+™ designer colors and stainless steel trim



PRO+™ REFRIGERATED DRAWERS

Model:	APRO60RDE
Width:	23 7/8" (60.6 cm)
Height:	34" (86.4 cm)
Depth:	24 1/4" (61.6 cm)
Electrical Requirements:	115 V, 60 Hz (on a separate 15 amp circuit)
Features:	<ul style="list-style-type: none"> • Exclusive Sentry System™ refrigeration monitor • White drawer interiors • Extra-deep lower drawer • Full extension drawer slides • LED light system • Black cabinet, drawer fronts available in all 4 PRO+™ designer colors and stainless steel • Optional organization accessories available (See page 17)

AGA PRO+™ UNITS ARE BACKED BY AN ATTRACTIVE WARRANTY

RANGE - One (1) year warranty on parts and labor with the exception of cosmetic damage to painted porcelain enamel finish or plated surfaces. Second and third year limited warranty on heating elements.

REFRIGERATOR - One (1) year limited warranty on all parts and labor with the exception of cosmetic damage to painted finish or plated surfaces. Second through fifth year warranty on any part of the sealed refrigeration system (consisting of compressor, evaporator, condenser, drier and connection tubing) and the cabinet liner (exclusive to the door liner) which fail in normal home use.

DISHWASHER - One (1) year limited warranty on all parts and labor with the exception of cosmetic damage to painted finish or plated surfaces. Second through fifth year limited warranty on nylon dish racks, wash and drain motor, electronic controls and heating element if defective in materials or workmanship. Lifetime limited warranty on stainless steel tub and inner door.

VENT HOOD - One (1) year limited warranty on all parts and labor with the exception of cosmetic damage to painted finish or plated surfaces.

UNDERCOUNTER REFRIGERATION - One (1) year limited warranty on all parts and labor with the exception of cosmetic damage to painted finish or plated surfaces. Second through fifth year limited warranty on sealed refrigeration system (consisting of compressor, condenser, drier, accumulator, bypass valve, connecting tubing and evaporator) which fail under normal home use.

Warranties apply to product only in the country in which it was purchased. Product is not intended for commercial installations. Warranty is void in any commercial-type application. Changes to the product may have occurred from the time this brochure was printed. Please obtain a current installation manual for your purchased model before beginning installation or rough-ins. Local authorities govern installation codes. In most areas, a licensed gas fitter or plumber is required.





AGA MARVEL

1050 Fountain Street N.
Cambridge, Ontario N3H 4R7 Canada
Tel. 519-650-5775 Fax. 800-327-5609
Toll Free 877-650-5775
www.agamarvel.com

© AGA MARVEL 2010
APROLIT0210E

The information presented herein is based on the best data available at time of printing and is believed to be correct. However, nothing stated herein is to be taken as warranty, expressed or implied, regarding the accuracy of the information or the use of our product or products. Specifications are subject to change without notice.

For more information on our family of brands, please visit their corresponding websites:



www.heartlandapp.com



www.marvelrefrigeration.com



www.marvelscientific.com



www.northlandnka.com



Mixed Sources

Product group from well-managed
forests and other controlled sources
www.fsc.org Cert no. SW-COC-002333
© 1996 Forest Stewardship Council



www.aga-ranges.com