

Professional Sealed Side Burners



BGB132-BI Double Side Burners, Built-in (as shown)

Every chef wants the option of preparing a delicious side dish to accompany a culinary masterpiece. For this, DCS offers Professional Sealed Side Burners for built-in application and for 30" grill cart mount application. Constructed of heavy stainless steel, DCS side burners rated at a powerful 17,000 Btu's, are available in single or double burner configurations. Features include battery ignition, stainless steel grate cover and, of course, the same sleek design as DCS professional grills.

ADDITIONAL FEATURES:

- Stainless steel grate cover included
- Removable stainless steel drip tray
- Designer metal control knobs
- See page 43 for available configurations

Outdoor Warming Drawer



WD-27-SS-OD 27" Outdoor Warming Drawer (as shown)

Keep cooked foods perfectly warm until dinner is completely ready with the DCS Outdoor Warming Drawer. Our warming drawer includes a removable stainless steel shelf. That means there is enough space for up to 6 standard-sized dinner plates. With an expansive 1.6 cubic feet of space, thermostatically controlled temperature ranges from 175 to 230 degrees, dinner will always be ready when you are.

ADDITIONAL FEATURES:

- Removable stainless steel shelf/serving tray
- 500 watts of power input
- Outdoor UL approval

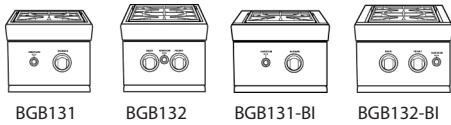

Built-in Side Burner Dimensions

BGB131-BI Single Side Burner

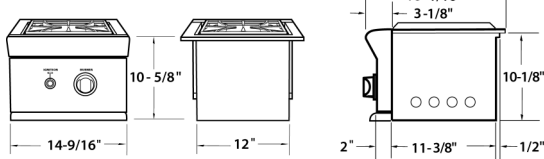

BGB132-BI Double Side Burner

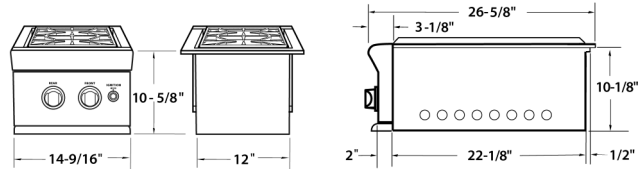

30" Cart Mount Side Burner Dimensions

BGB131 Single Side Burner

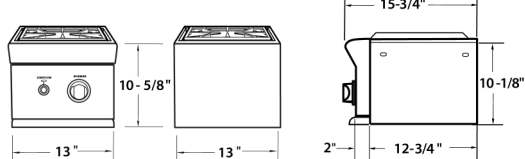

BGB132 Double Side Burner

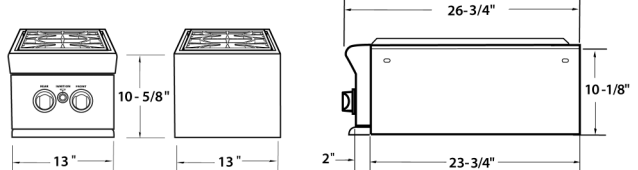

NOTE: Cart Mount Side Burners are not designed for built-in applications.

Professional Side Burner Island Preparation

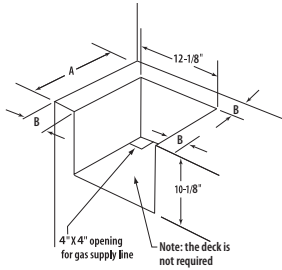

MODEL	A	B
BGB131-BI	12"	6" min.
BGB132-BI	22-3/8"	6" min.

MODEL NUMBER	BGB131	BGB131-BI	BGB132	BGB132-BI
30" CART MOUNT	✓		✓	
BUILT-IN		✓		✓
SIDE BURNER(S)	1 @ 17,000 Btu/hr	1 @ 17,000 Btu/hr	2 @ 17,000 Btu/hr	2 @ 17,000 Btu/hr
SHIPPING WEIGHT (LBS)	35.4	35.8	60.6	64.0
SHIPPING DIMENSIONS (HEIGHT X WIDTH X DEPTH)	13.5 x 14.5 x 19	13.5 x 14.5 x 19	16 x 18 x 30	16 x 18 x 30

Ordering Data: Please specify gas type (natural or propane) when ordering.

Gas Requirements:

Natural

- 1/2" NPT male with a 3/8" flare adapter
- Operational Pressure: 4" W.C.
- Supply Pressure: 6" to 9" W.C.

Propane

- 1/2" NPT male with a 3/8" flare adapter
- Operational Pressure: 10" W.C.
- Supply Pressure: 11" to 14" W.C.

Warming Drawer Dimensions

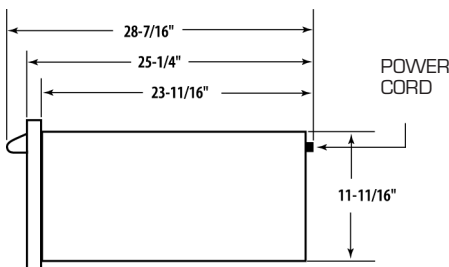
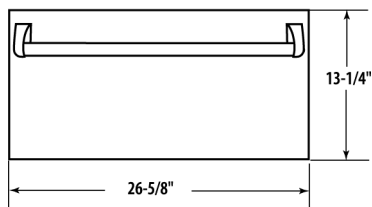

Warming Drawer Island Preparation

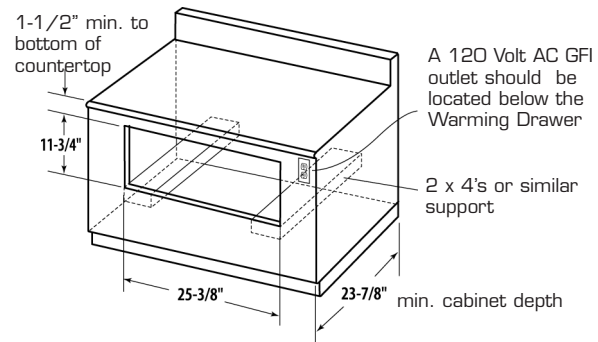

MODEL NUMBER	WD-27-SS-OD
DRAWER SPACE	1.6 CUBIC FEET
REMOVABLE SHELF/SERVING TRAY	✓
TYPE 304 STAINLESS STEEL	✓

Power Requirements:

- 120V 60Hz
- 3 wire
- 15 amp circuit