

WOLF DESIGN GUIDE





CONTENTS

Wolf L Series Built-In Ovens	4
Wolf E Series Built-In Ovens	9
Wolf Microwave Ovens	15
Wolf Warming Drawers	22
Wolf Induction Cooktops	30
Wolf Electric Cooktops	36
Wolf Gas Cooktops	50
Wolf Integrated Modules	55
Wolf Dual Fuel Ranges	64
Wolf Sealed Burner Rangetops	71
Wolf Gas Ranges	77
Wolf Gas Rangetops	84
Wolf Outdoor Grills	88
Wolf Cooktop Ventilation	92
Wolf Pro Ventilation	102
Ventilation Recommendations	115
Wolf Warranty	121

Features and specifications indicated herein and on our website are subject to change at any time without notice. Check our website, wolfappliance.com, for the most up-to-date specifications.

IMPORTANT NOTE

As you follow these instructions, you will notice warning and caution symbols. This blocked information is important for the safe and efficient installation of Wolf equipment. There are two types of potential hazards that may occur during installation.

⚠ CAUTION

signals a situation where minor injury or product damage may occur if you do not follow instructions.

⚠ WARNING

states a hazard that may cause serious injury or death if precautions are not followed.

Another footnote we would like to identify is IMPORTANT NOTE: This highlights information that is especially relevant to a problem-free installation.



WELCOME TO WOLF APPLIANCE

In this Design Guide, you'll find all the necessary information for specifying a Wolf oven, cooktop, range, rangetop, outdoor grill or ventilation equipment into the next kitchen or home you design.

Each unit is handcrafted with the knowledge and experience gleaned from being the premier supplier of cooking equipment to professional chefs and their restaurants for nearly 75 years.

Sub-Zero, a corporate companion and kitchen soul mate, shares the identical values and pride we take in providing the best cooking equipment.

A Wolf is beautiful and will complement any design you use, whether it be contemporary or traditional.

But that's not why many customers turn to us. We have a passion for cooking and it shows in our work. Consumers appreciate the unique features we have built in to our many different models. You can refer to specifics as you page through this guide.

The features are as numerous as the various units you have to choose from. But one of the more prominent highlights is the Wolf Dual Convection System that is in all our built-in ovens and dual fuel ranges. It delivers even temperature and airflow throughout the oven. Its combination of fans and heating elements operate either simultaneously or in sequence, depending on which of the ten different cooking modes your client chooses.

In addition, our dual-stacked burners on the gas cooktops, dual fuel ranges and sealed burner rangetops are all sealed and offer you the capability of simmering foods.

Our electric cooktops are unique to the industry with their capabilities of providing simmer on all elements and the melt feature on one of the elements. Our new electric cooktops, available in November, will also include bridge elements and timer functions.

If you are looking for cooking performance, but don't want to shout it out in your kitchen design, one of our unframed electric cooktops may be your choice. There's no stainless steel trim, just the sophisticated black ceramic glass top that can be mounted flush with the top of the countertop or as a frameless installation sitting on top of the countertop surface.

The sizes, alternative tops, and selection of the standard classic stainless steel and the premium finishes of carbon or platinum stainless steel make your decision-making process much more fun for you and your clients. Now you can give them exactly what they want without sacrificing the quality they demand.

In all your applications you can depend on Wolf. That reputation is even stronger because it is backed by Sub-Zero. The combination of the two is really greater than their sum.

Each Wolf unit is backed by the best warranty in the business. Please refer to pages 122-123 for details.

Review this Design Guide in greater detail when you get a chance and keep it as a handy reference. We are confident you will like what you see.

CONTACT INFORMATION

Wolf Customer Service:
800-332-9513

Website:
wolfappliance.com



L SERIES BUILT-IN OVENS



Model SO30F



Model SO30U



Model SO36U

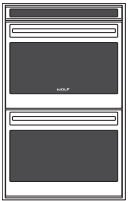

Model DO30F

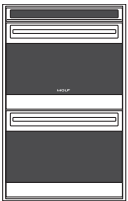

Model DO30U

WOLF L SERIES BUILT-IN OVENS

It's hard to put into a few words the differences you will see in the Wolf built-in ovens compared to others on the market. Some of those differences are very dramatic, like the two premium finishes offered in our L Series built-in ovens along with the standard classic stainless steel.

The platinum look lets you have the beauty of stainless steel without the sheen and reduces the number of fingerprints, whereas the carbon stainless steel is unlike any other black appliance you have experienced.

Look closer and you will see two different door styles offered—framed and unframed. The framed is more traditional and lends itself nicely with a professional rangetop, while the unframed is sleek and contemporary in appearance.

Did you notice that the control panel closes? It's an attractive feature and will enable you to hide that control panel that many of us have labored to make functional and tried to make beautiful.

Inside, the beauty, design and functionality continue. Brilliant halogen lights illuminate the beautiful blue interior. As you open the oven door, feel the smoothness of the door damper system. Pull that bottom oven rack all the way out and notice how it is nestled on the door rails. With the dual convection fans, all L Series models offer ten different cooking modes.

FEATURES

Framed and unframed door styles available

Dual convection logic control system

Ten cooking modes—bake, roast, broil, convection bake, convection roast, convection broil, convection, bake stone (accessory required), dehydrate (accessory required) and proof

Rotating glass touch control panel

Cobalt blue porcelain oven interior

Three removable racks, six-level rack guide and full-extension bottom rack—five-level rack guide for 36" (914) oven

Large viewing triple-pane window

Dual interior halogen lighting

Hidden bake element and recessed broil element

Temperature probe and receptacle

Self-clean, delayed start and Sabbath features

Door hinge with hydraulic damper assures smooth opening and closing of the door

Factory-installed trim

CSA certified for US and Canada



This appliance is certified by Star-K to meet strict religious regulations in conjunction with specific instructions found on www.star-k.org.

BUILT-IN OVEN FEATURES

Model SO30F/S shown

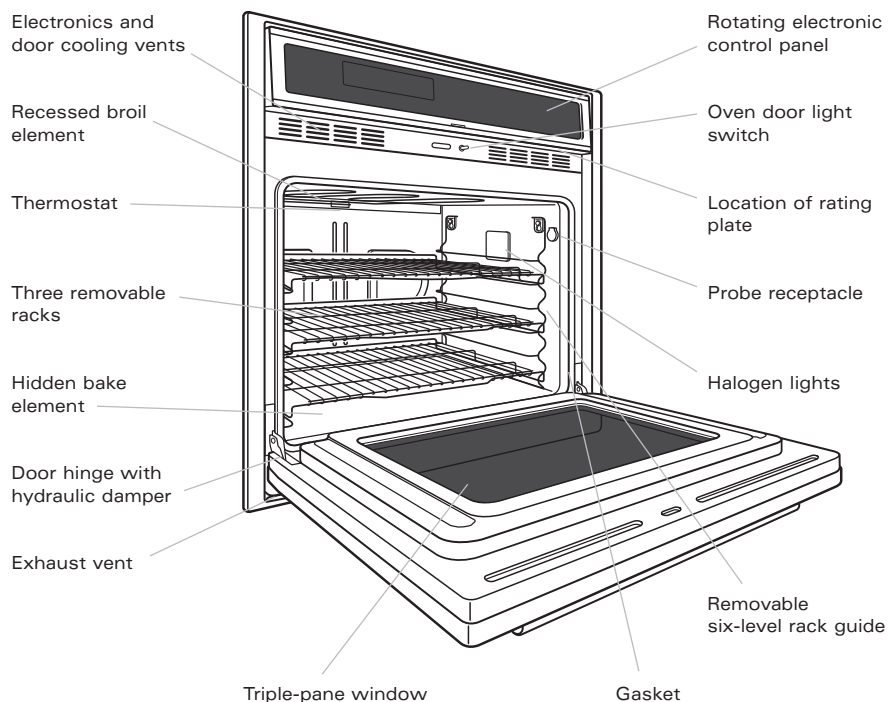

Dimensions in parentheses are in millimeters unless otherwise specified.



PLANNING INFORMATION

While you have many design options to consider, there are only three different sizes to consider when planning for your layout. You can choose either a 30" (762) or 36" (914) built-in single oven or a 30" (762) double oven.

For ease of installation, Wolf recommends using 33" (838) wide cabinets with 30" (762) ovens and 39" (991) wide cabinets with the 36" (914) oven. You will need a minimum 24" (610) of usable cabinet depth. The cabinet must be able to support 250 lbs (113 kg) for a single oven and 400 lbs (181 kg) for a double oven.

Wolf L Series built-in ovens have a face trim on all four sides and will overlap stiles and rails. The trim overlaps $\frac{3}{16}$ " (5) on the top, $\frac{1}{8}$ " (3) on the bottom and $\frac{3}{4}$ " (19) on each side.

Specifications on the following pages provide overall dimensions, rough openings and installation specifics for the three different oven sizes. We have minimized the information contained in the illustrations, concentrating on the critical information you need to plan your installation.

A Wolf single oven may be installed below an induction, electric or gas cooktop. Wolf built-in ovens are designed and agency approved for installation with Wolf cooktops only. Refer to the electric and gas cooktops sections for additional specifications. A built-in oven cannot be installed below a Wolf rangetop.

ELECTRICAL REQUIREMENTS

L Series single ovens require a separate, grounded 4-wire 240/208 V AC, 60 Hz, 30 amp service with its own circuit breaker. Double ovens require a separate, grounded 4-wire 240/208 V AC, 60 Hz, 50 amp service with its own circuit breaker.

IMPORTANT NOTE: Unless you are using cabinets deeper than 24" (610), it is recommended that the electrical supply be placed in an adjacent cabinet within reach of the conduit. A 2" (51) diameter hole to route the conduit through cabinetry will be required. Refer to the Installation Specifications illustrations on the following pages for location of the electrical supply.

You must follow all National Electrical Code regulations. In addition, be aware of local codes and ordinances when installing your service.

WOLF WARRANTY

Wolf products are covered by a two and five year residential warranty (exclusions apply). See warranty details at the end of this guide.

MODEL OPTIONS

L Series Built-In Ovens

30" (762) Single Oven - Framed

Classic Stainless **SO30F/S**

30" (762) Single Oven - Unframed

Classic Stainless **SO30U/S**

Platinum Stainless **SO30U/P**

Carbon Stainless **SO30U/B**

36" (914) Single Oven - Unframed

Classic Stainless **SO36U/S**

Platinum Stainless **SO36U/P**

Carbon Stainless **SO36U/B**

30" (762) Double Oven - Framed

Classic Stainless **DO30F/S**

30" (762) Double Oven - Unframed

Classic Stainless **DO30U/S**

Platinum Stainless **DO30U/P**

Carbon Stainless **DO30U/B**

Stainless steel finishes.

This appliance must be installed in accordance with National Electrical Code regulations as well as all state, municipal and local codes. The correct voltage, frequency and amperage must be supplied to the appliance from a dedicated, grounded circuit that is protected by a properly sized circuit breaker or time delay fuse. The proper voltage, frequency and amperage ratings are listed on the product rating plate.

ACCESSORIES

L Series Built-In Ovens

Bake stone accessory, includes stone, rack and peel

Additional oven racks

Two-piece broiler pan and temperature probe

Dehydration racks with door stop

Accessories are available through your Wolf dealer. To obtain local dealer information, visit the Showroom Locator section of our website, wolfappliance.com.



L SERIES BUILT-IN OVENS

MODEL OPTIONS

30" (762) L Series Built-In Single Oven

Framed / Classic	SO30F/S
Unframed / Classic	SO30U/S
Unframed / Platinum	SO30U/P
Unframed / Carbon	SO30U/B

SPECIFICATIONS

30" (762) L Series Built-In Single Oven

Overall Dimensions (W x H x D)	29⁷/₈" x 27¹/₂" x 24" (759 x 699 x 610)
Door Clearance	20³/₄" (527)
Overall Oven Interior Capacity	4.5 cu ft (127 L)
Overall Interior Dim (W x H x D)	25" x 16¹/₂" x 19" (635 x 419 x 483)
Usable Interior Dim (W x H x D)	21¹/₂" x 16¹/₂" x 16³/₈" (546 x 419 x 416)
Cabinet Width	33" (838) rec 30" (762) min
Cabinet Depth	24" (610) min
Min Base Support	250 lbs (113 kg)
Opening Width	28¹/₂" (724)
Opening Height	27³/₁₆" (691)
Trim Overlaps	3/16" (5) top 1/8" (3) bottom 3/4" (19) each side
Electrical Supply	240/208 V AC, 60 Hz 30 amp circuit
Conduit	4' (1.2 m) flexible 4-wire
Electrical Rating	5.1 kW at 240 V 3.8 kW at 208 V
Total Amps	21
Shipping Weight	273 lbs (124 kg)

INSTALLATION OPTIONS

The Wolf 30" (762) L Series single oven may be installed below a Wolf 30" (762) induction, electric or gas cooktop. Unless you are using cabinets deeper than 24" (610), it is recommended that the electrical supply be placed in the base cabinet to the right of the oven within reach of the conduit. It may also be installed below a 36" (914) induction, electric or gas cooktop.

A 30" (762) L Series single oven may be installed in combination with a Wolf microwave and warming drawer. Refer to the warming drawers section for specifications.

A 30" (762) L Series single oven may be installed next to another 30" (762) L Series single oven. You must allow for a 2¹/₂" (64) space between the oven rough openings. Also, a separate inner wall is required for each oven between openings.

Dimensions in parentheses are in millimeters unless otherwise specified.

OVERALL DIMENSIONS

30" (762) L Series Built-In Single Oven

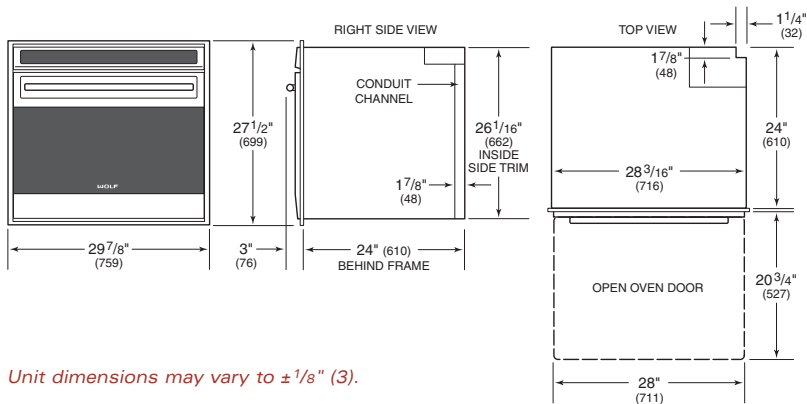

Unit dimensions may vary to ±1/8" (3).

INSTALLATION SPECIFICATIONS

30" (762) L Series Built-In Single Oven

Wall Application

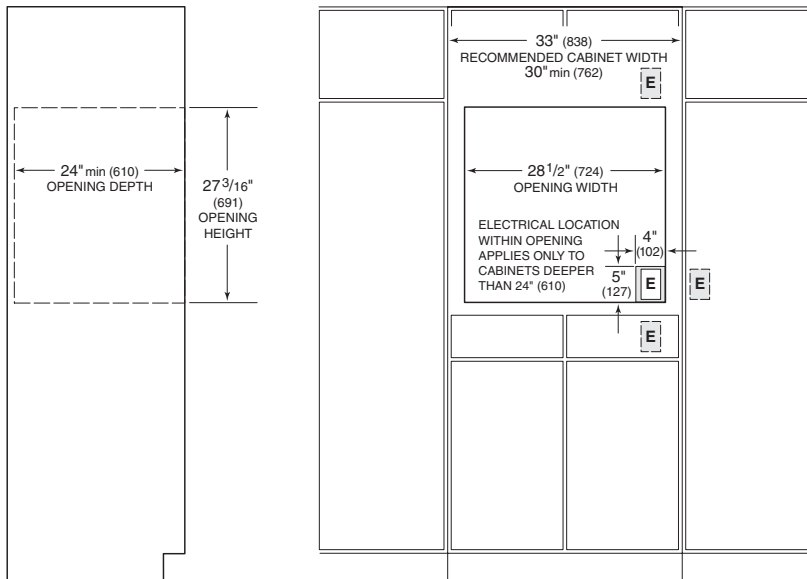

Undercounter Installation

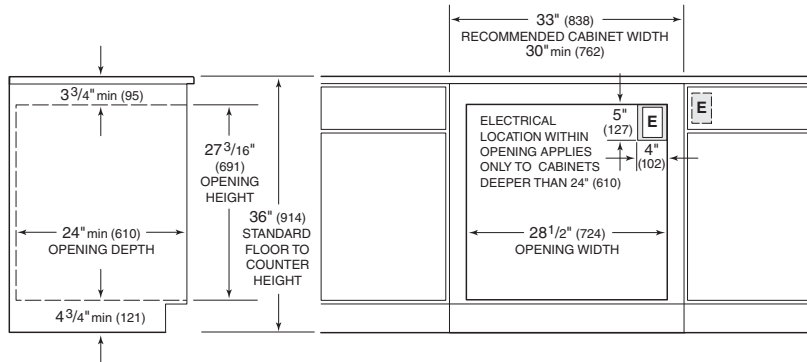

IMPORTANT NOTE: Unless you are using cabinets deeper than 24" (610), it is recommended that the electrical supply be placed in an adjacent cabinet within reach of the conduit. Choose the location shown in the illustrations that best suits your installation.



OVERALL DIMENSIONS

36" (914) L Series Built-In Single Oven

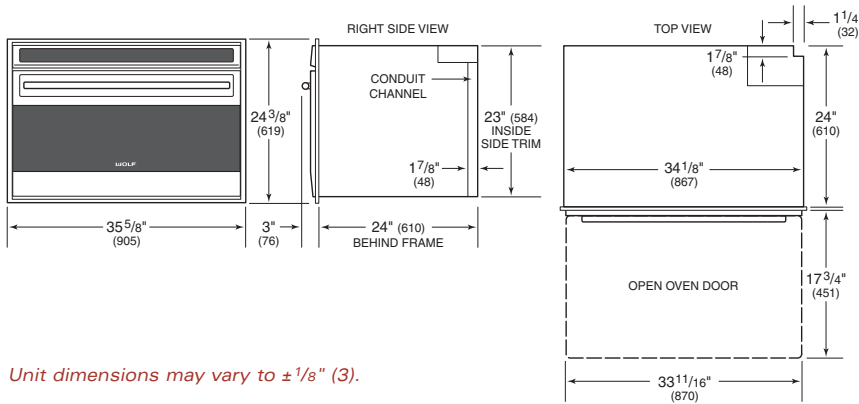

Unit dimensions may vary to ±1/8" (3).

MODEL OPTIONS

36" (914) L Series Built-In Single Oven

- Unframed / Classic **SO36U/S**
- Unframed / Platinum **SO36U/P**
- Unframed / Carbon **SO36U/B**

SPECIFICATIONS

36" (914) L Series Built-In Single Oven

- Overall Dimensions (W x H x D) **35 5/8" x 24 3/8" x 24"**
(905 x 619 x 610)
- Door Clearance **17 3/4" (451)**
- Overall Oven Interior Capacity **4.4 cu ft (125 L)**
- Overall Interior Dim (W x H x D) **30" x 13 1/4" x 19"**
(762 x 337 x 483)
- Usable Interior Dim (W x H x D) **26 1/2" x 13 1/4" x 16 3/8"**
(673 x 337 x 416)
- Cabinet Width **39" (991) rec**
36" (914) min
- Cabinet Depth **24" (610) min**
- Min Base Support **250 lbs (113 kg)**
- Opening Width **34 1/2" (876)**
- Opening Height **24 1/16" (611)**
- Trim Overlaps **3/16" (5) top**
1/8" (3) bottom
3/4" (19) each side
- Electrical Supply **240/208 V AC, 60 Hz**
30 amp circuit
- Conduit **3' (.9 m) flexible 4-wire**
- Electrical Rating **5.1 kW at 240 V**
3.8 kW at 208 V
- Total Amps **21**
- Shipping Weight **288 lbs (131 kg)**

INSTALLATION SPECIFICATIONS

36" (914) L Series Built-In Single Oven

Wall Application

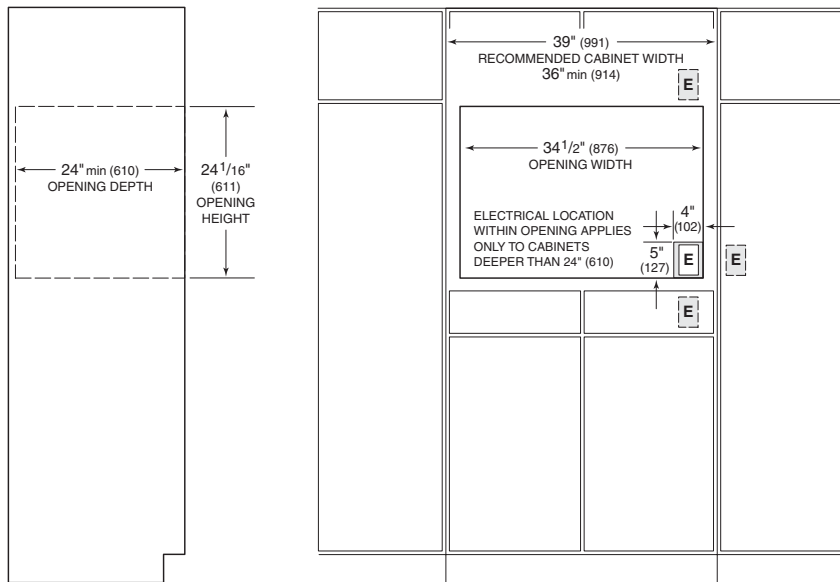

Undercounter Installation

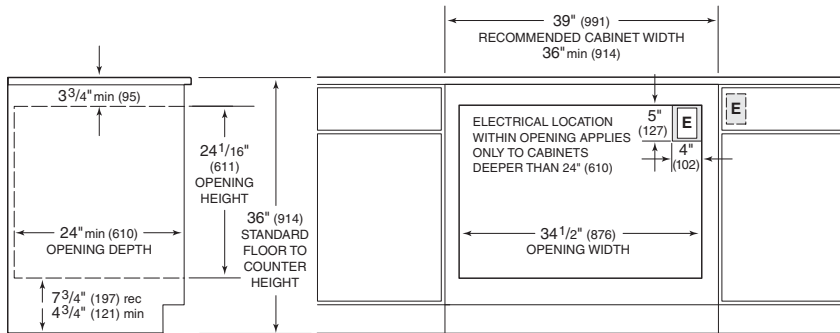

IMPORTANT NOTE: Unless you are using cabinets deeper than 24" (610), it is recommended that the electrical supply be placed in an adjacent cabinet within reach of the conduit. Choose the location shown in the illustrations that best suits your installation.

INSTALLATION OPTIONS

The Wolf 36" (914) L Series single oven may be installed below a Wolf 36" (914) induction, electric or gas cooktop. It may also be installed below a 30" (762) induction or framed electric cooktop or gas cooktop, but not below a 30" (762) unframed electric cooktop or gas cooktop. When installed below a cooktop, it is recommended that the opening for the oven be 7 3/4" (197) from the floor to ease use of the oven door.

A 36" (914) L Series single oven may be installed above or below a Wolf warming drawer with integrated drawer front. This installation may also include a convection microwave with 36" (914) trim. Refer to the warming drawers section for specifications.

A 36" (914) L Series single oven may be installed directly above another 36" (914) oven. You must allow enough space between the oven rough openings to accommodate a base support for the top oven. It may also be installed next to another 36" (914) oven. You must allow for a 2 1/2" (64) space between the oven rough openings. Also, a separate inner wall is required for each oven between openings. Each base cabinet support must be able to support 250 lbs (113 kg).



L SERIES BUILT-IN OVENS

OVERALL DIMENSIONS

L Series Built-In Double Oven

MODEL OPTIONS

L Series Built-In Double Oven

Framed / Classic	DO30F/S
Unframed / Classic	DO30U/S
Unframed / Platinum	DO30U/P
Unframed / Carbon	DO30U/B

SPECIFICATIONS

L Series Built-In Double Oven

Overall Width	29⁷/₈" (759)
Overall Height	50" (1270)
Overall Depth	24" (610)
Door Clearance	20³/₄" (527)
Overall Oven Interior Capacity (per oven)	4.5 cu ft (127 L)
Overall Interior Dim (W x H x D)	25" x 16¹/₂" x 19" (635 x 419 x 483) each
Usable Interior Dim (W x H x D)	21¹/₂" x 16¹/₂" x 16³/₈" (546 x 419 x 416) each
Cabinet Width	33" (838) rec 30" (762) min
Cabinet Depth	24" (610) min
Min Base Support	400 lbs (181 kg)
Opening Width	28¹/₂" (724)
Opening Height	49⁵/₈" (1260)
Trim Overlaps	3¹/₁₆" (5) top 1¹/₈" (3) bottom 3¹/₄" (19) each side
Electrical Supply	240/208 V AC, 60 Hz 50 amp circuit
Conduit	5' (1.5 m) flexible 4-wire
Electrical Rating	8.9 kW at 240 V 6.7 kW at 208 V
Total Amps	37
Shipping Weight	466 lbs (211 kg)

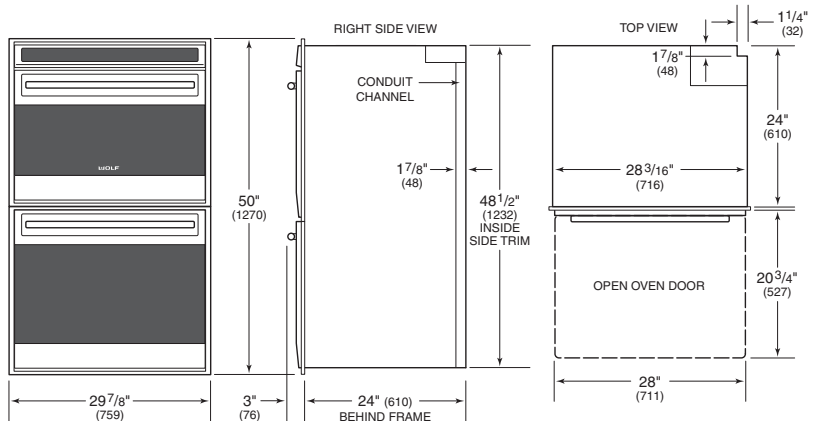

Unit dimensions may vary to ±1/8" (3).

INSTALLATION SPECIFICATIONS

L Series Built-In Double Oven

Wall Application

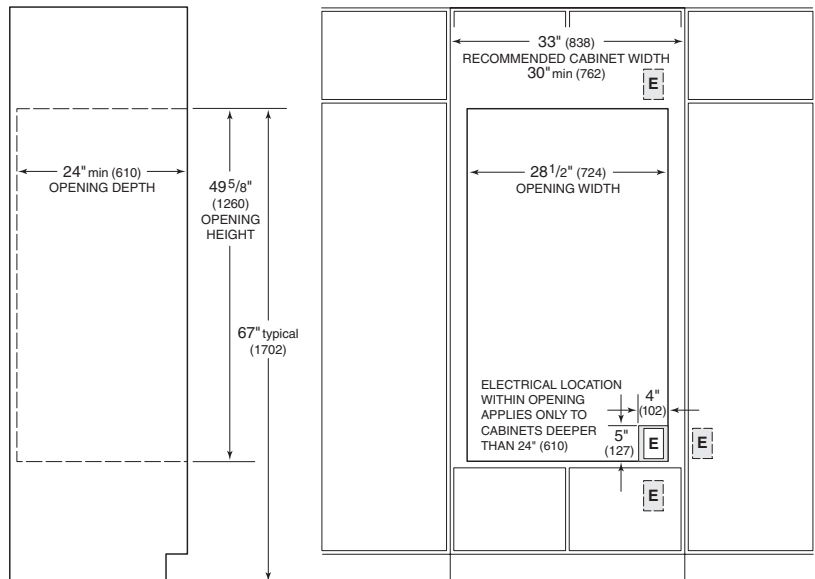

IMPORTANT NOTE: Unless you are using cabinets deeper than 24" (610), it is recommended that the electrical supply be placed in an adjacent cabinet within reach of the conduit. Choose the location shown in the illustrations that best suits your installation.

Dimensions in parentheses are in millimeters unless otherwise specified.

Refer to installation instructions shipped with each Wolf product for detailed specifications.



WOLF E SERIES BUILT-IN OVENS

Wolf E Series built-in ovens come with the classic stainless steel finish and are offered in two different door styles—framed and unframed. The framed is more traditional and lends itself nicely with a professional rangetop, while the unframed is sleek and contemporary in appearance.

The E Series built-in design allows the front of the oven to be installed flush with surrounding cabinetry for a more integrated look or used in the standard application, where the oven trim will overlap the cabinet face.

Inside, the beauty, design and functionality continue. Brilliant halogen lights illuminate the beautiful blue interior. Pull that bottom oven rack all the way out and notice how it is nestled on the door rails. With the dual convection fans, all E Series models offer ten different cooking modes.

FEATURES

Framed and unframed door styles available

Classic stainless steel finish

Dual convection logic control system—lower oven on double ovens is non-convection

Ten cooking modes—bake, roast, broil, convection bake, convection roast, convection broil, convection, bake stone (accessory required), dehydrate (accessory required) and proof

Cobalt blue porcelain oven interior

Three removable racks with full-extension bottom rack and removable six-level rack guides

Large viewing double-pane window

Dual interior halogen lighting

Hidden bake element and recessed broil element

Temperature probe and receptacle

Self-clean, delayed start and Sabbath features

Balanced door hinges assure smooth opening and closing of the doors

CSA certified for US and Canada

NEW



Model SO30-2F/S

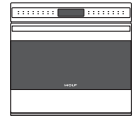

Model SO30-2U/S

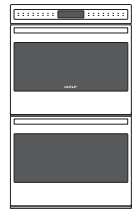

Model DO30-2F/S

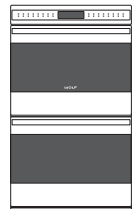

Model DO30-2U/S



This appliance is certified by Star-K to meet strict religious regulations in conjunction with specific instructions found on www.star-k.org.

E SERIES BUILT-IN OVEN FEATURES

Model SO30-2U/S shown

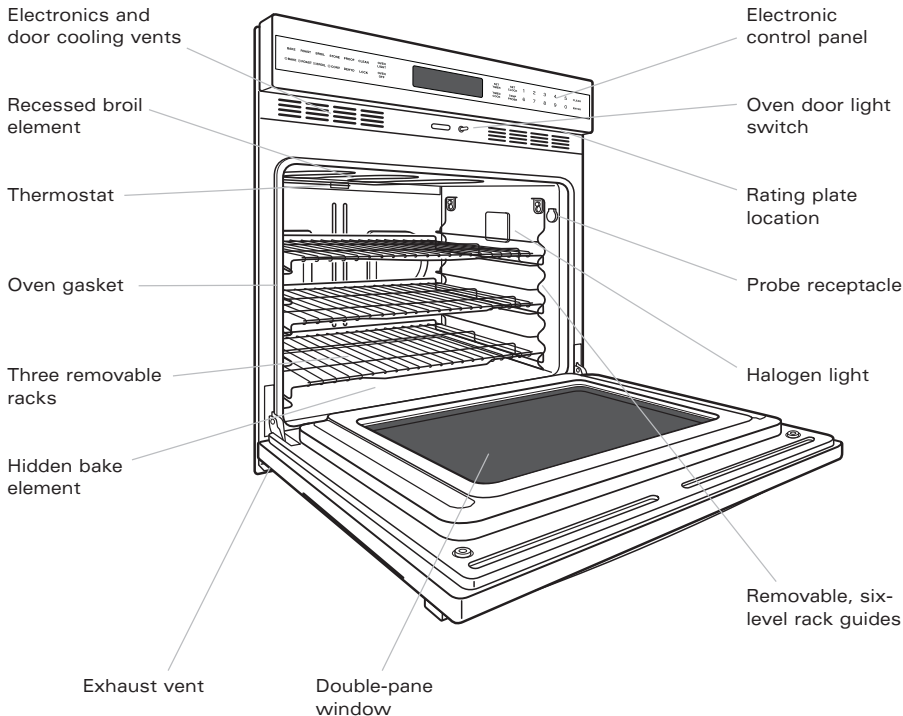

PLANNING INFORMATION

Wolf E Series built-in ovens are available as a 30" (762) wide single oven or 30" (762) double oven in framed or unframed door styles.

For ease of installation, Wolf recommends using 33" (838) wide cabinets with the E Series ovens. The cabinet base platform must be able to support 250 lbs (113 kg) for a single oven and 400 lbs (181 kg) for a double oven.

For standard installations, the oven is installed by inserting into cabinetry from the front. The oven has a face trim on all four sides and will overlap stiles and rails. The trim overlaps $\frac{5}{8}$ " (16) on the top, $\frac{1}{8}$ " (3) on the bottom and $\frac{3}{4}$ " (19) on each side.

The flush inset installation requires the oven to be recessed into the cabinet. A minimum 33" (838) wide and 25" (635) deep cabinet is needed if you want the front of the oven to be flush with surrounding cabinetry.

Specifications on the following pages provide overall dimensions, rough openings and installation specifics for E Series built-in ovens.

A Wolf E Series single oven may be installed below an induction, electric or gas cooktop. Wolf built-in ovens are designed and agency approved for installation with Wolf cooktops only. Refer to the electric and gas cooktops sections for additional specifications.

ELECTRICAL REQUIREMENTS

E Series single ovens require a separate, grounded 3-wire 240/208 V AC, 60 Hz, 30 amp service with its own circuit breaker. Double ovens require a separate, grounded 3-wire 240/208 V AC, 60 Hz, 50 amp service with its own circuit breaker.

IMPORTANT NOTE: Unless you are using cabinets deeper than 24" (610) for a standard installation or 25" (635) for a flush inset installation, it is recommended that the electrical supply be placed in an adjacent cabinet within reach of the conduit. A 2" (51) diameter hole to route the conduit through cabinetry will be required. Refer to the Installation Specifications illustrations on the following pages for location of the electrical supply.

You must follow all National Electrical Code regulations. In addition, be aware of local codes and ordinances when installing your service.

WOLF
WARRANTY

Wolf products are covered by a two and five year residential warranty (exclusions apply). See warranty details at the end of this guide.

MODEL OPTIONS

*E Series Built-In Ovens***Single Oven**

Framed	SO30-2F/S
Unframed	SO30-2U/S

Double Oven

Framed	DO30-2F/S
Unframed	DO30-2U/S

This appliance must be installed in accordance with National Electrical Code regulations as well as all state, municipal and local codes. The correct voltage, frequency and amperage must be supplied to the appliance from a dedicated, grounded circuit that is protected by a properly sized circuit breaker or time delay fuse. The proper voltage, frequency and amperage ratings are listed on the product rating plate.

ACCESSORIES

E Series Built-In Ovens

Bake stone accessory, includes stone, rack and peel

Additional oven racks

Two-piece broiler pan and temperature probe

Dehydration racks with door stop

Accessories are available through your Wolf dealer. To obtain local dealer information, visit the Showroom Locator section of our website, wolfappliance.com.

Dimensions in parentheses are in millimeters unless otherwise specified.



OVERALL DIMENSIONS

E Series Built-In Single Oven

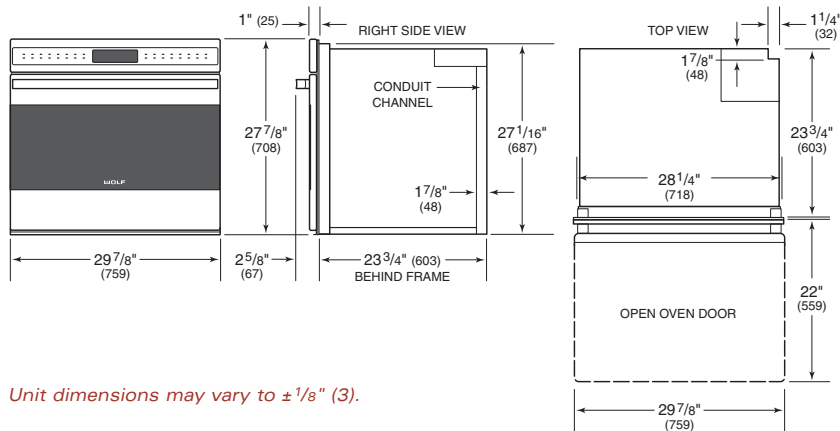

Unit dimensions may vary to $\pm 1/8$ " (3).

MODEL OPTIONS

E Series Built-In Single Oven

Framed	SO30-2F/S
Unframed	SO30-2U/S

SPECIFICATIONS

E Series Built-In Single Oven

Overall Width	29 7/8" (759)
Overall Height	27 7/8" (708)
Overall Depth	23 3/4" (603)
Door Clearance	22" (559)
Overall Oven Interior Capacity	4.5 cu ft (127 L)
Overall Interior Dim (W x H x D)	25" x 16 1/2" x 19" (635 x 419 x 483)
Usable Interior Dim (W x H x D)	21 1/2" x 16 1/2" x 16 3/8" (546 x 419 x 416)
Min Cabinet Width	
Standard	30" (762)
Flush Inset	33" (838)
Min Cabinet Depth	
Standard	24" (610)
Flush Inset	25" (635)
Min Base Support	250 lbs (113 kg)
Opening Width	28 1/2" (724)
Flush Inset Width	30 3/8" (772) min
Opening Height	27 3/16" (691)
Flush Inset Height	28 1/2" (724) min
Trim Overlaps	5/8" (16) top 1/8" (3) bottom 3/4" (19) each side
Electrical Supply	240/208 V AC, 60 Hz 30 amp circuit
Conduit	4' (1.2 m) flexible 3-wire
Electrical Rating	5.1 kW at 240 V 3.8 kW at 208 V
Total Amps	21
Shipping Weight	273 lbs (124 kg)

INSTALLATION SPECIFICATIONS

E Series Built-In Single Oven

Standard Installation—Wall Application

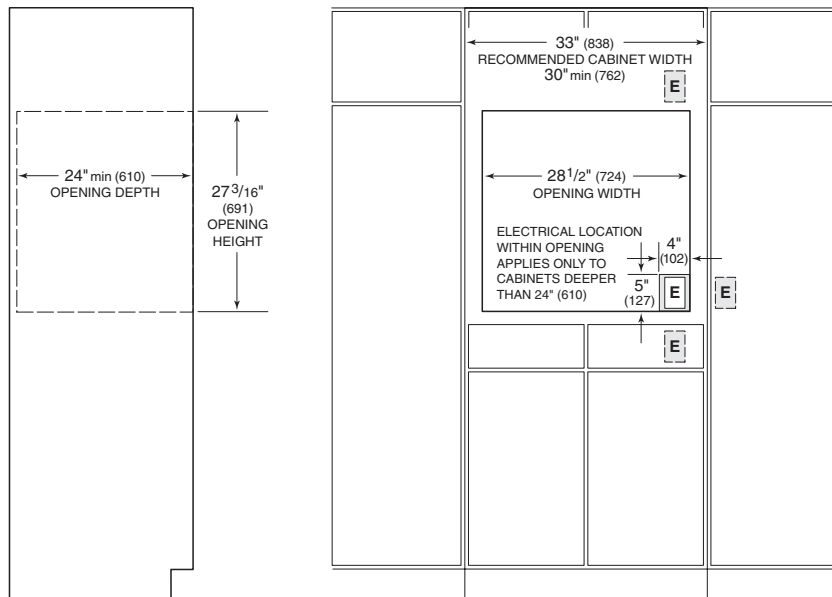

Standard Installation—Undercounter Application

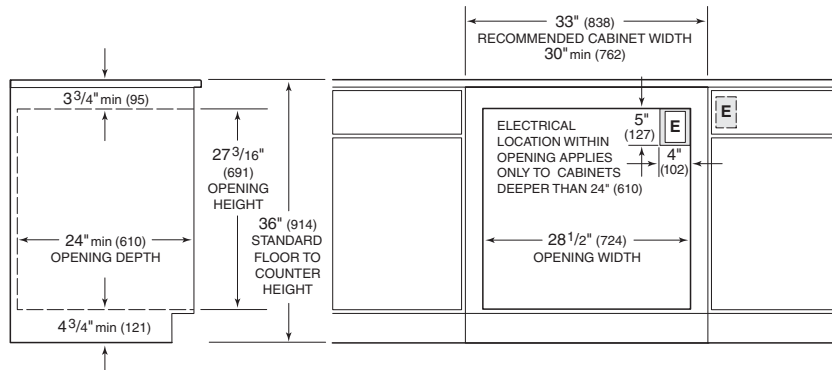

INSTALLATION OPTIONS

Wolf E Series built-in ovens may be used in a standard installation, where the face trim overlaps stiles and rails, or in a flush inset installation with the front of the oven flush with surrounding cabinetry. Refer to the following illustrations.

IMPORTANT NOTE: Unless you are using cabinets deeper than 24" (610) for a standard installation or 25" (635) for a flush inset installation, it is recommended that the electrical supply be placed in an adjacent cabinet within reach of the conduit. Choose the location shown in the illustrations that best suits your installation.



INSTALLATION SPECIFICATIONS

E Series Built-In Single Oven

Flush Inset Installation—Wall Application

INSTALLATION OPTIONS

The Wolf E Series single oven may be installed below a Wolf 30" (762) induction, electric or gas cooktop. Unless you are using cabinets deeper than 24" (610), it is recommended that the electrical supply be placed in the base cabinet to the right of the oven within reach of the conduit. It may also be installed below a 36" (914) induction, electric or gas cooktop.

An E Series single oven may be installed in combination with a Wolf microwave and warming drawer. Refer to the warming drawers section for specifications.

The E Series single oven may be installed next to another E Series single oven. You must allow for a 2 1/2" (64) space between the oven rough openings. Also, a separate inner wall is required for each oven between openings.

IMPORTANT NOTE: Unless you are using cabinets deeper than 24" (610) for a standard installation or 25" (635) for a flush inset installation, it is recommended that the electrical supply be placed in an adjacent cabinet within reach of the conduit. Choose the location shown in the illustration that best suits your installation.

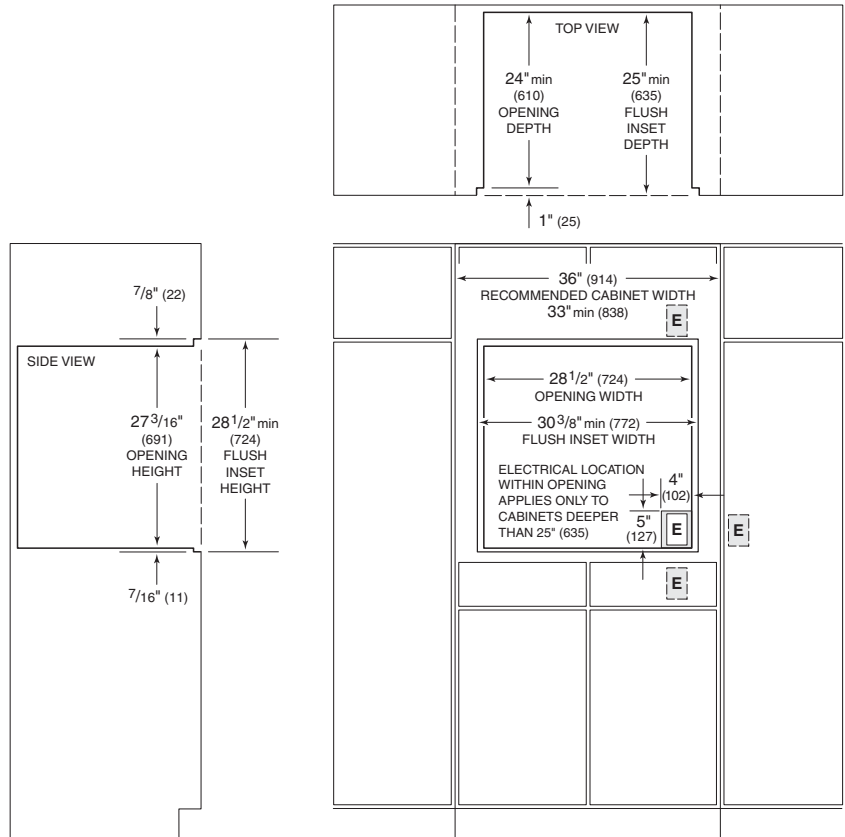

CAUTION

For flush inset installations, the inside edges of the rough opening must be finished, as they will be exposed when the oven door is open. These edges should be stained instead of having a laminated surface, to avoid damage from high temperatures during self-clean.

Dimensions in parentheses are in millimeters unless otherwise specified.



OVERALL DIMENSIONS
E Series Built-In Double Oven

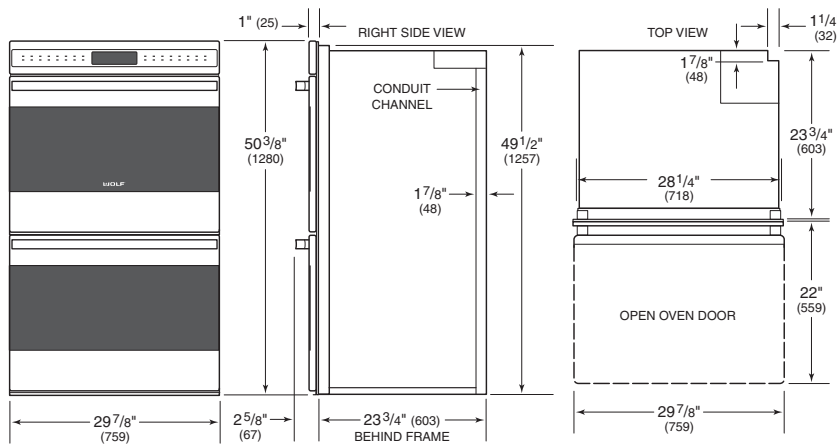

Unit dimensions may vary to ±1/8" (3).

INSTALLATION SPECIFICATIONS
E Series Built-In Double Oven
 Standard Installation

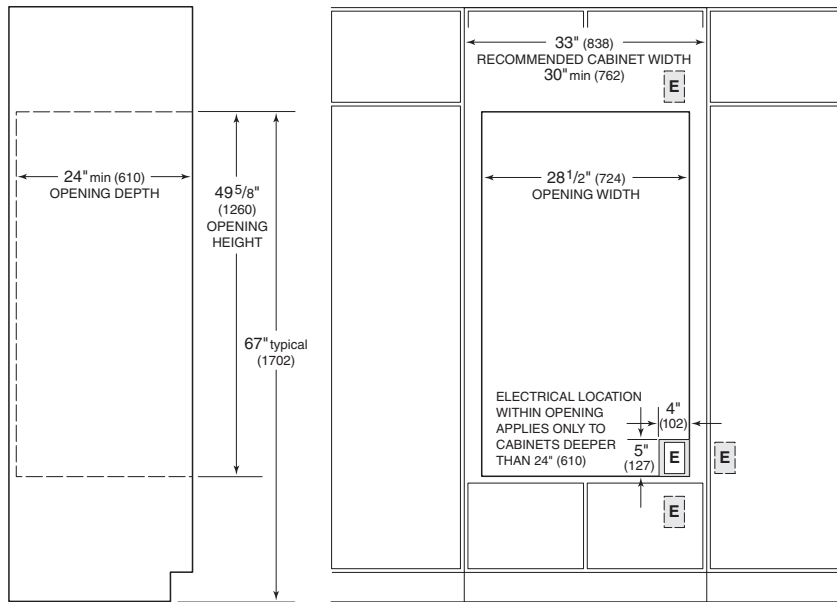

Refer to installation instructions shipped with each Wolf product for detailed specifications.

MODEL OPTIONS
E Series Built-In Double Oven

Framed	DO30-2F/S
Unframed	DO30-2U/S

SPECIFICATIONS
E Series Built-In Double Oven

Overall Width	29 7/8" (759)
Overall Height	50 3/8" (1280)
Overall Depth	23 3/4" (603)
Door Clearance	22" (559)
Overall Oven Interior Capacity (per oven)	4.5 cu ft (127 L)
Overall Interior Dim (W x H x D)	25" x 16 1/2" x 19" (635 x 419 x 483) each
Usable Interior Dim (W x H x D)	21 1/2" x 16 1/2" x 16 3/8" (546 x 419 x 416) each
Min Cabinet Width	
Standard	30" (762)
Flush Inset	33" (838)
Min Cabinet Depth	
Standard	24" (610)
Flush Inset	25" (635)
Min Base Support	400 lbs (181 kg)
Opening Width	28 1/2" (724)
Flush Inset Width	30 3/8" (772) min
Opening Height	49 5/8" (1260)
Flush Inset Height	50 15/16" (1294) min
Trim Overlaps	5/8" (16) top 1/8" (3) bottom 3/4" (19) each side
Electrical Supply	240/208 V AC, 60 Hz 50 amp circuit
Conduit	5' (1.5 m) flexible 3-wire
Electrical Rating	8.9 kW at 240 V 6.7 kW at 208 V
Total Amps	37
Shipping Weight	466 lbs (211 kg)

INSTALLATION OPTIONS

Wolf E Series built-in ovens may be used in a standard installation, where the face trim overlaps stiles and rails, or in a flush inset installation with the front of the oven flush with surrounding cabinetry. Refer to the following illustrations.

IMPORTANT NOTE: Unless you are using cabinets deeper than 24" (610) for a standard installation or 25" (635) for a flush inset installation, it is recommended that the electrical supply be placed in an adjacent cabinet within reach of the conduit. Choose the location shown in the illustration that best suits your installation.



E SERIES BUILT-IN OVENS

INSTALLATION SPECIFICATIONS

E Series Built-In Double Oven

Flush Inset Installation

INSTALLATION OPTIONS

The Wolf E Series double oven may be installed in combination with a Wolf warming drawer. Refer to the warming drawers section for specifications.

IMPORTANT NOTE: Unless you are using cabinets deeper than 24" (610) for a standard installation or 25" (635) for a flush inset installation, it is recommended that the electrical supply be placed in an adjacent cabinet within reach of the conduit. Choose the location shown in the illustration that best suits your installation.

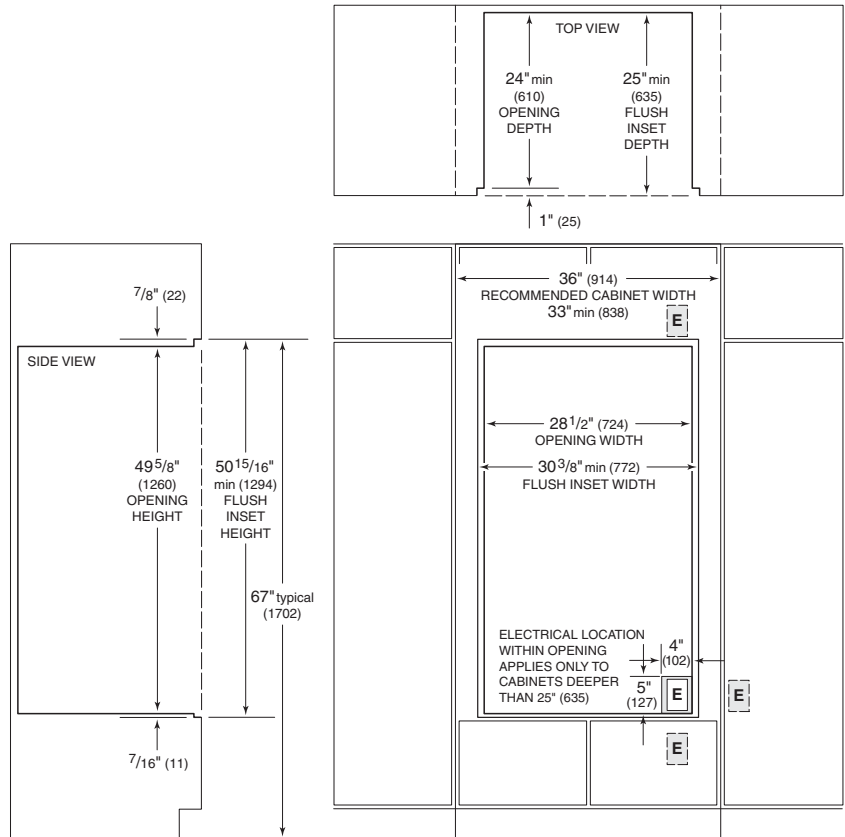

CAUTION

For flush inset installations, the inside edges of the rough opening must be finished, as they will be exposed when the oven door is open. These edges should be stained instead of having a laminated surface, to avoid damage from high temperatures during self-clean.

Dimensions in parentheses are in millimeters unless otherwise specified.

Refer to installation instructions shipped with each Wolf product for detailed specifications.



WOLF CONVECTION MICROWAVE

Taking the experience we've gained from our microwave ovens and combining that with the expertise of convection, Wolf has brought the best of both cooking technologies together in one unit.

Model MWC24 is available with trim kits to mount the unit above a 30" (762) or 36" (914) L Series oven or 30" (762) E Series oven to finish off your cooking tower in a single look. The L Series trim is offered in 30" (762) and 36" (914) widths and three stainless steel finishes—classic, platinum and carbon. E Series trim comes in 27" (686) and 30" (762) widths with the classic stainless steel finish only.

Aside from looking beautiful whether you use it in conjunction with an oven or not, the unit offers you all the performance you expect from Wolf—a cooking company with a heritage of nearly 75 years in the kitchen.

FEATURES

Built-in or freestanding convection microwave oven with 1.5 cu ft (42 L) capacity and 900 watts of power

L Series trim kits allow microwave to be built in to fit above a 30" (762) or 36" (914) L Series oven

E Series trim kit allows microwave to be built in to fit above a 30" (762) E Series oven—27" (686) E Series trim kit also available

Classic, platinum or carbon stainless steel finishes for L Series trim kits—classic stainless steel finish for E Series trim kits

Sensor cooking

Slow cook mode for up to four hours

Easy-to-operate control panel and programmable power options

Interactive display—99 minutes, 99 seconds

Menu label and food guide

Multi-language—English, French and Spanish

Removable turntable and turntable support

Microwave tray for popcorn and meat

Multiple-rack baking

Safety door latches—oven will not operate unless the door is closed

Oven light comes on when oven is operating or door is open

Tight door seals with one-touch door open pad



Model MWC24 Freestanding



Model MWC24 30" (762) L Series Trim



Model MWC24 36" (914) L Series Trim

NEW



Model MWC24 27" (686) E Series Trim



Model MWC24 30" (762) E Series Trim

CONVECTION MICROWAVE FEATURES

Model MWC24

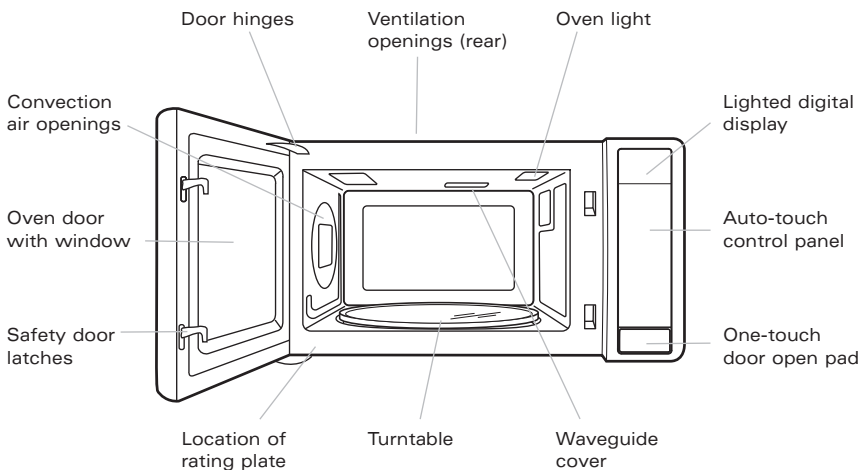



PLANNING INFORMATION

The Wolf convection microwave oven can be used freestanding or with an optional trim kit. 30" (762) and 36" (914) L Series trim kits and 27" (686) and 30" (762) E Series trim kits are available. These trim kits match Wolf L Series and E Series built-in ovens. With a trim kit the microwave can be built-in to fit above an L Series or E Series single oven of corresponding style and width.

IMPORTANT NOTE: In all instances where the microwave oven is built in, you must use one of the trim kits to ensure proper ventilation.

The Wolf convection microwave oven with trim kit will overlap stiles and rails. Trim overlaps for the 30" (762) L Series and E Series trim kits and the 36" (914) L Series trim kit are 13/16" (21) on the bottom, 5/16" (8) on the top and 13/16" (30) on each side. Trim overlaps for the 27" (686) E Series trim kit are 13/16" (21) on the top and bottom, and 5/8" (16) on each side.

IMPORTANT NOTE: While the look of the 30" (762) L Series and E Series trim kits will differ, the installation dimensions are the same.

Refer to the installation instructions provided with the trim kit for detailed specifications.

When using the Wolf convection microwave oven as a freestanding unit, allow 2" (51) of airflow space on top, rear and both sides. A minimum 20 1/8" (511) cabinet depth is required.

Specifications on the following pages provide overall dimensions, rough openings and installation options for the convection microwave oven. We have minimized the information contained in the illustrations, concentrating on the critical information you need to plan your installation.

The Wolf convection microwave oven with 30" (762) trim kit may be installed in combination with a 30" (762) single oven and 30" (762) warming drawer with stainless steel drawer front. Be sure to order the trim kit that matches the series of oven you are using in your design.

With the 36" (914) L Series trim kit, the convection microwave may be installed in combination with a 36" (914) L Series single oven and warming drawer with integrated drawer front. Refer to installation options on the following pages.

ELECTRICAL REQUIREMENTS

The Wolf convection microwave oven requires a separate, grounded 110/120 V AC, 60 Hz power supply. The service should have its own 15 amp circuit breaker, and a grounded 3-prong receptacle should be located within reach of the power cord.

IMPORTANT NOTE: A ground fault circuit interrupter (GFCI) is not recommended and may cause interruption of operation.

You must follow all National Electrical Code regulations. In addition, be aware of local codes and ordinances when installing your service.

WOLF WARRANTY

Wolf products are covered by a two and five year residential warranty (exclusions apply). See warranty details at the end of this guide.

Dimensions in parentheses are in millimeters unless otherwise specified.

TRIM KIT OPTIONS

Model MWC24

30" (762) L Series Stainless Steel Trim

Classic Trim	MWCTRIM30/S
Platinum Trim	MWCTRIM30/P
Carbon Trim	MWCTRIM30/B

36" (914) L Series Stainless Steel Trim

Classic Trim	MWCTRIM36/S
Platinum Trim	MWCTRIM36/P
Carbon Trim	MWCTRIM36/B

27" (686) E Series Stainless Steel Trim

Classic Trim	MWCTRIM27-2/S
--------------	---------------

30" (762) E Series Stainless Steel Trim

Classic Trim	MWCTRIM30-2/S
--------------	---------------

Optional trim kits are ordered and shipped as a sales accessory. Accessories are available through your Wolf dealer. To obtain local dealer information, visit the Showroom Locator section of our website, wolfappliance.com.



OVERALL DIMENSIONS

Model MWC24 with L Series Trim

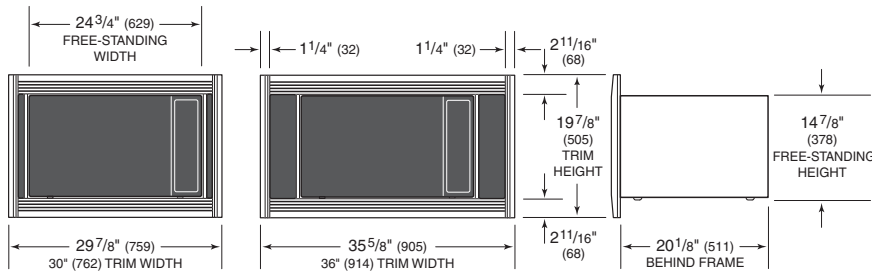

Unit dimensions may vary to ±1/8" (3).

SPECIFICATIONS

Model MWC24
Convection Microwave (freestanding)

Overall Width	24 3/4" (629)
Overall Height	14 7/8" (378)
Overall Depth	20 1/8" (511)
Interior Oven Cap	1.5 cu ft (42 L)
Interior Oven Dim (W x H x D)	16 1/8" x 9 5/8" x 16 1/8" (410 x 244 x 410)
Electrical Supply	120 V AC, 60 Hz 15 amp circuit
Power	900 W
Power Requirement (with convection)	1.6 kw
Power Cord	3 1/2' (1.1 m) 3-prong
Shipping Weight	68 lbs (31 kg)

INSTALLATION SPECIFICATIONS

Model MWC24 with 30" (762) L Series Trim

Wall Application

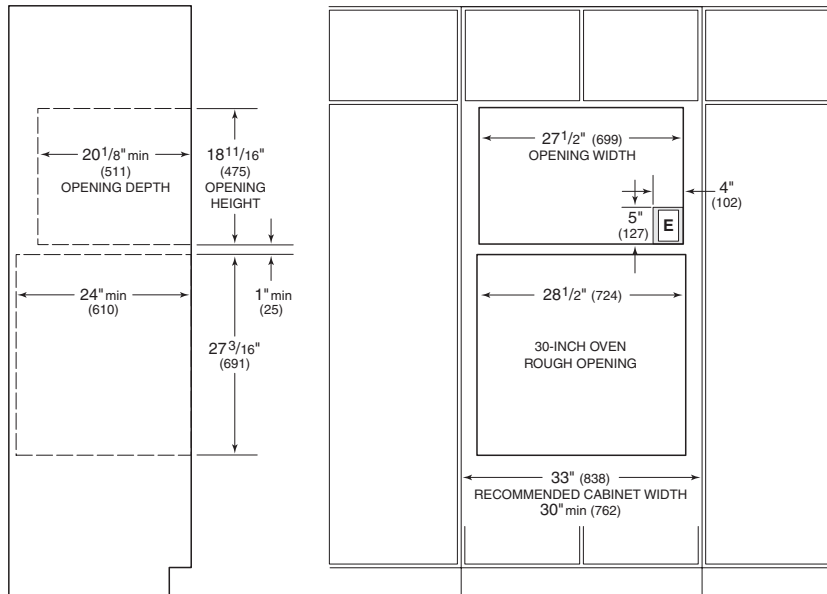

SPECIFICATIONS

Model MWC24 with 30" (762) L Series Trim

Overall Width	29 7/8" (759)
Overall Height	19 7/8" (505)
Overall Depth	20 1/8" (511)
Cabinet Width	33" (838) rec 30" (762) min
Min Base Support	125 lbs (57 kg)
Opening Width	27 1/2" (699)
Opening Height	18 11/16" (475)
Opening Depth	20 1/8" (511) min
Trim Overlaps	5/16" (8) top 13/16" (21) bottom 1 3/16" (30) each side

Undercounter Installation

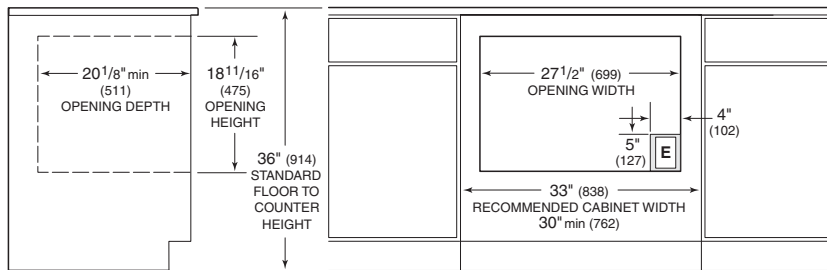

SPECIFICATIONS

Model MWC24 with 36" (914) L Series Trim

Overall Width	35 5/8" (905)
Overall Height	19 7/8" (505)
Overall Depth	20 1/8" (511)
Cabinet Width	39" (991) rec 36" (914) min
Min Base Support	125 lbs (57 kg)
Opening Width	33 3/8" (854)
Opening Height	18 11/16" (475)
Opening Depth	20 1/8" (511) min
Trim Overlaps	5/16" (8) top 13/16" (21) bottom 1 3/16" (30) each side

Unit dimensions may vary to ±1/8" (3).

IMPORTANT NOTE: For installation of the convection microwave with 36" (914) L Series trim, add 6" (152) to the overall width dimensions shown in the illustrations.

Refer to installation instructions provided with the trim kit for detailed specifications.



OVERALL DIMENSIONS

Model MWC24 with E Series Trim

SPECIFICATIONS

Model MWC24 with 30" (762) E Series Trim

Overall Width	29⁷/₈" (759)
Overall Height	19⁷/₈" (505)
Overall Depth	20¹/₈" (511)
Cabinet Width	33" (838) rec 30" (762) min
Min Base Support	125 lbs (57 kg)
Opening Width	27¹/₂" (699)
Opening Height	18¹¹/₁₆" (475)
Opening Depth	20¹/₈" (511) min
Trim Overlaps	5⁵/₁₆" (8) top 13¹³/₁₆" (21) bottom 1³/₁₆" (30) each side

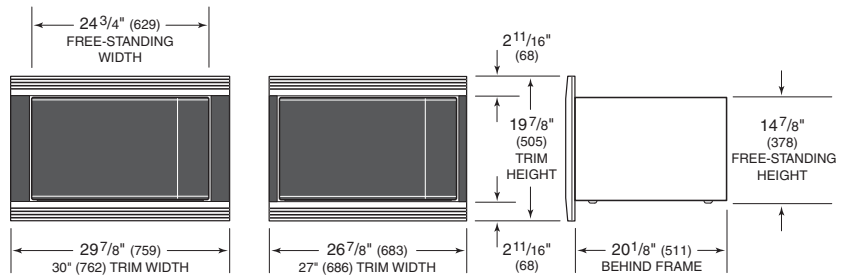

Unit dimensions may vary to ±1/8" (3).

INSTALLATION SPECIFICATIONS

Model MWC24 with 30" (762) E Series Trim

Wall Application

SPECIFICATIONS

Model MWC24 with 27" (686) E Series Trim

Overall Width	26⁷/₈" (683)
Overall Height	19⁷/₈" (505)
Overall Depth	20¹/₈" (511)
Cabinet Width	30" (762) rec
Min Base Support	125 lbs (57 kg)
Opening Width	25¹/₄" (641)
Opening Height	18¹¹/₁₆" (475)
Opening Depth	20¹/₈" (511) min
Trim Overlaps	13¹³/₁₆" (21) top 13¹³/₁₆" (21) bottom 5⁵/₈" (16) each side

Unit dimensions may vary to ±1/8" (3).

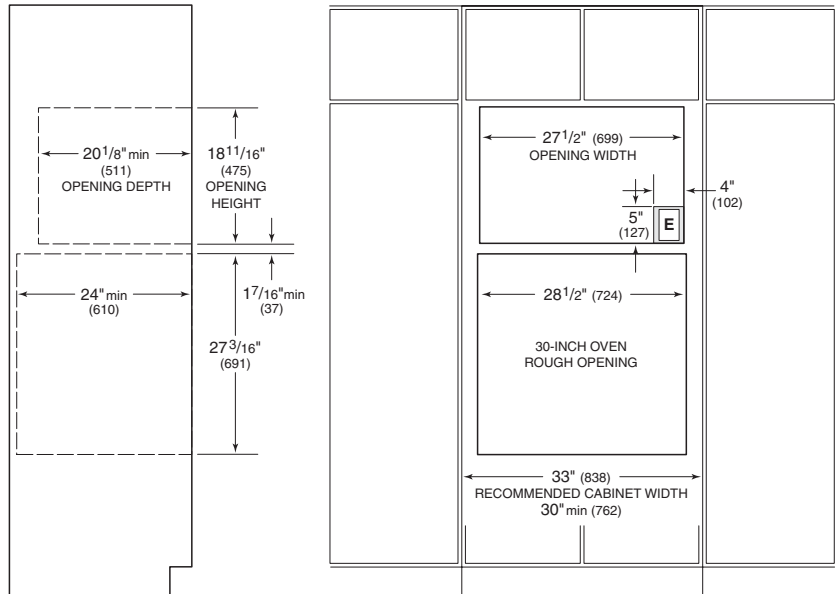

Model MWC24 with 27" (686) E Series Trim

Undercounter Installation

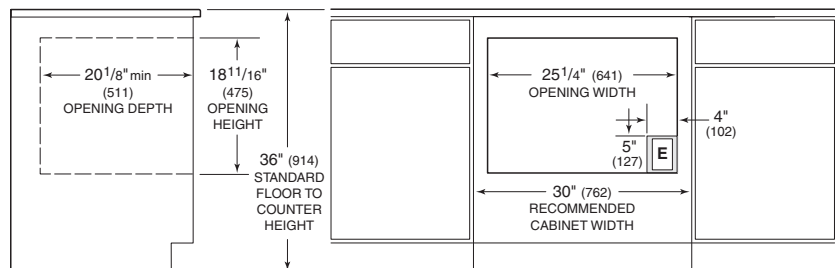

Dimensions in parentheses are in millimeters unless otherwise specified.



WOLF STANDARD MICROWAVE

What sort of microwave oven can you expect from a cooking company? This is the only standard microwave that deserves the Wolf name.

It's fast—1200 watts on high. Roomy—a full 2.0 cu ft (57 L). And it is a true cooking instrument with a vast range of advanced features, including sensor cooking controlled from an interactive display.

Model MW24 is available with trim kits that allow the unit to be built in to fit above a Wolf L Series or E Series oven. The E Series trim also comes in a 27" (686) width. All trim kits have the classic stainless steel finish.

FEATURES

Built-in or freestanding standard microwave oven with 2.0 cu ft (57 L) capacity and 1200 watts of power

Trim kits allow microwave to be built in to fit above a 30" (762) L Series or E Series oven—27" (686) E Series trim kit also available

Classic stainless steel trim finish

Sensor cooking

Easy-to-operate control panel and programmable power options

Interactive display—99 minutes, 99 seconds

Warming feature

Menu label and food guide

Multi-language—English, French and Spanish

Removable turntable and support

Safety door latches—oven will not operate unless the door is closed

Oven light comes on when oven is operating or door is open

Tight door seals with one-touch door open pad



Model MW24 Freestanding

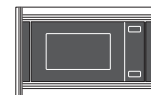

Model MW24 30" (762) L Series Trim



Model MW24 27" (686) E Series Trim



Model MW24 30" (762) E Series Trim

STANDARD MICROWAVE FEATURES

Model MW24

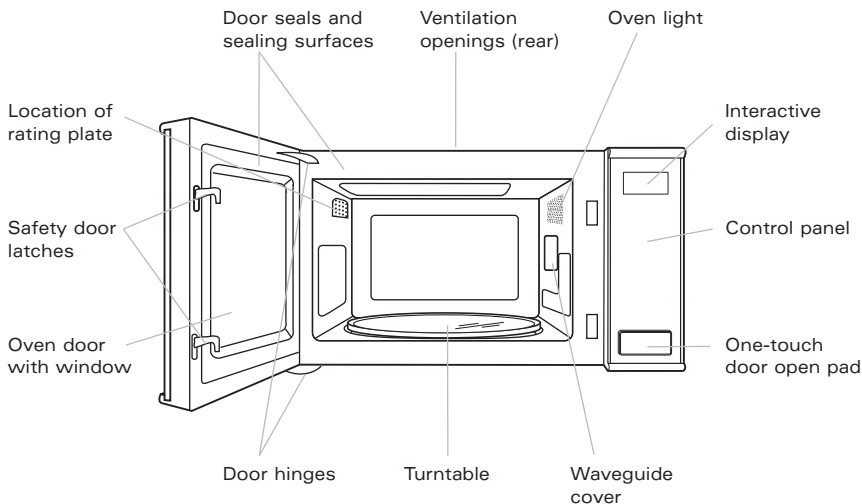



PLANNING INFORMATION

The Wolf standard microwave oven can be used freestanding or with an optional trim kit. A 30" (762) L Series trim kit and 27" (686) and 30" (762) E Series trim kits are available.

With a 30" (762) trim kit, the microwave can be built in to fit above a Wolf L Series or E Series single oven and/or warming drawer with L Series or E Series stainless steel drawer front.

IMPORTANT NOTE: In all instances where the microwave oven is built in, you must use one of the trim kits to ensure proper ventilation.

The Wolf standard microwave oven with trim kit will overlap stiles and rails. Trim overlaps for the 30" (762) L Series and E Series trim kit are 13/16" (21) on the bottom, 7/16" (11) on the top and 1 3/16" (30) on each side. Trim overlaps for the 27" E Series trim kit are 1 3/16" (21) on the top and bottom and 3/4" (19) on each side.

IMPORTANT NOTE: While the look of the 30" (762) L Series and E Series trim kits will differ, the installation dimensions are the same.

In a freestanding application, allow 2" (51) of airflow space on top, rear and both sides. A minimum 20" (508) cabinet depth is required.

ELECTRICAL REQUIREMENTS

The Wolf microwave oven requires a separate, grounded 120 V AC, 60 Hz power supply. The service should have its own 15 amp circuit breaker, and a grounded 3-prong receptacle should be located within reach of the power cord.

IMPORTANT NOTE: A ground fault circuit interrupter (GFCI) is not recommended and may cause interruption of operation.

You must follow all National Electrical Code regulations. In addition, be aware of local codes and ordinances when installing your service.

WOLF WARRANTY

Wolf products are covered by a two and five year residential warranty (exclusions apply). See warranty details at the end of this guide.

OVERALL DIMENSIONS

Model MW24 with L Series Trim

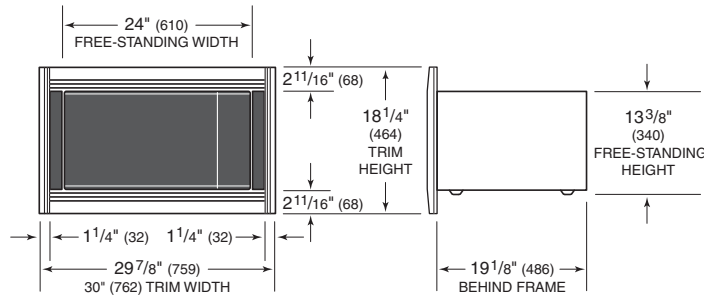

Model MW24 with E Series Trim

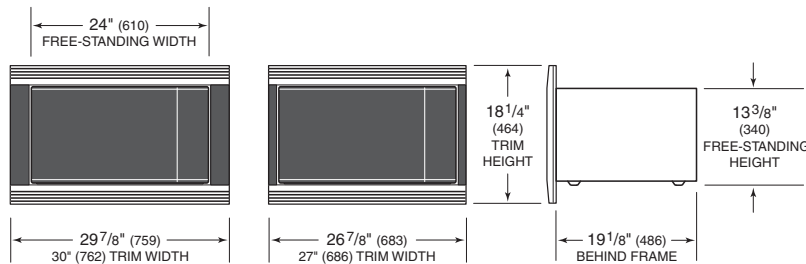

TRIM KIT OPTIONS

Model MW24

30" (762) L Series Stainless Steel Trim

Classic Trim MWTRIM30/S

27" (686) E Series Stainless Steel Trim

Classic Trim MWTRIM27-2/S

30" (762) E Series Stainless Steel Trim

Classic Trim MWTRIM30-2/S

Optional trim kits are ordered and shipped as a sales accessory. Accessories are available through your Wolf dealer. To obtain local dealer information, visit the Showroom Locator section of our website, wolfappliance.com.

Dimensions in parentheses are in millimeters unless otherwise specified.

Unit dimensions may vary to ±1/8" (3).



INSTALLATION SPECIFICATIONS

Model MW24 with 30" (762) L Series Trim
 Wall Application

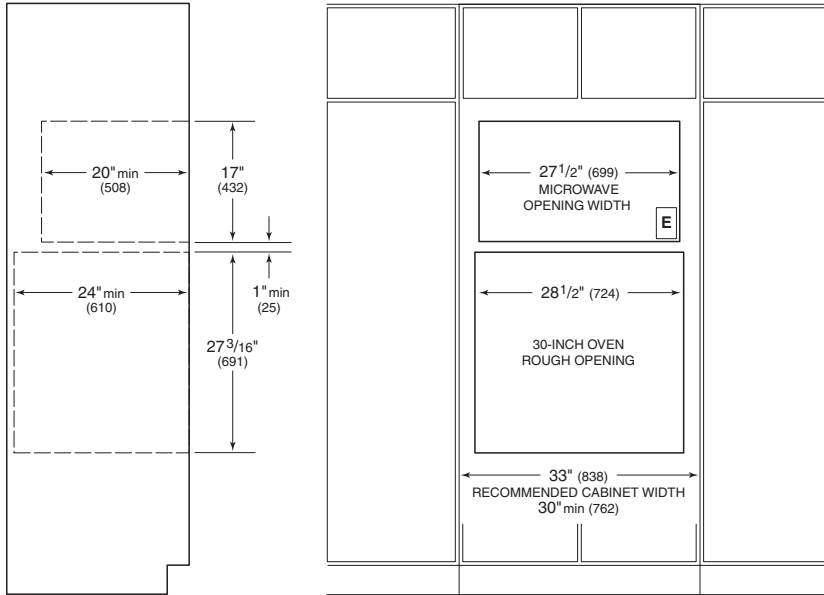

SPECIFICATIONS

Model MW24
 Standard Microwave (freestanding)

Overall Width	24" (610)
Overall Height	13³/₈" (340)
Overall Depth	19¹/₈" (486)
Interior Oven Cap	2.0 cu ft (57 L)
Interior Oven Dim (W x H x D)	17³/₈" x 10¹/₂" x 18⁵/₈" (441 x 267 x 473)
Electrical Supply	120 V AC, 60 Hz 15 amp circuit
Power	1200 W
Power Cord	3' (.9 m) 3-prong
Shipping Weight	50 lbs (23 kg)

SPECIFICATIONS

Model MW24 with 30" (762) L Series Trim

Overall Width	29⁷/₈" (759)
Overall Height	18¹/₄" (464)
Overall Depth	19¹/₈" (486)
Cabinet Width	33" (838) rec 30" (762) min
Min Base Support	125 lbs (57 kg)
Opening Width	27¹/₂" (699)
Opening Height	17" (432)
Opening Depth	20" (508) min
Trim Overlaps	7/16" (11) top 1³/₁₆" (21) bottom 1³/₁₆" (30) each side

INSTALLATION SPECIFICATIONS

Model MW24 with 30" (762) E Series Trim
 Wall Application

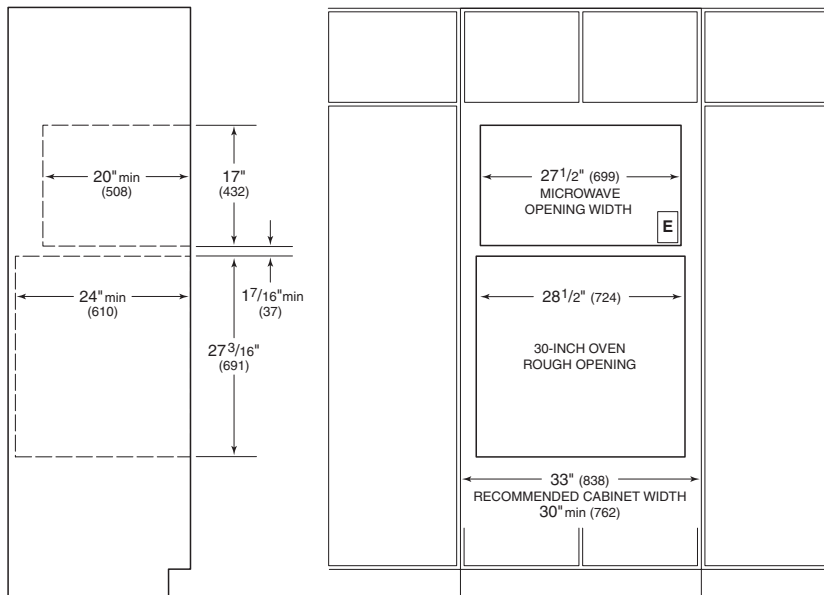

SPECIFICATIONS

Model MW24 with 30" (762) E Series Trim

Overall Width	29⁷/₈" (759)
Overall Height	18¹/₄" (464)
Overall Depth	19¹/₈" (486)
Cabinet Width	33" (838) rec 30" (762) min
Min Base Support	125 lbs (57 kg)
Opening Width	27¹/₂" (699)
Opening Height	17" (432)
Opening Depth	20" (508) min
Trim Overlaps	7/16" (11) top 1³/₁₆" (21) bottom 1³/₁₆" (30) each side

SPECIFICATIONS

Model MW24 with 27" (686) E Series Trim

Overall Width	26⁷/₈" (683)
Overall Height	18¹/₄" (464)
Overall Depth	19¹/₈" (486)
Cabinet Width	30" (762) rec
Min Base Support	125 lbs (57 kg)
Opening Width	25¹/₄" (641)
Opening Height	17" (432)
Opening Depth	20" (508) min
Trim Overlaps	1³/₁₆" (21) top 1³/₁₆" (21) bottom 3/4" (19) each side

NOTE: Installation of Model MW24 with 27" (686) E Series trim not shown.

Unit dimensions may vary to ±1/8" (3).



WOLF WARMING DRAWER

Warming drawers have a clear mission in life—to take good care of good food until it’s time for you to eat. Our superior air control helps keep moist foods moist and crisp foods crisp. In addition, Wolf warming drawers are among the most spacious on the market, so you will have little problem storing items.

There is a rack for stacking food plus an optional set of six stainless steel containers with lids that divide the drawer into sections, keeping different dishes warm at the same time.

From a design perspective, you have several choices for the drawer front. Electronic controls are hidden regardless of your panel selection. Stainless steel drawer fronts are available to match the look of the Wolf L Series and E Series built-in ovens. For the L Series drawer front, choose from the classic stainless steel look or the premium finishes of platinum or carbon stainless steel. E Series drawer fronts come in the classic stainless steel finish and framed and unframed door styles to match E Series ovens.

Also available is the integrated drawer front, which allows for a custom wood panel. Wolf offers optional decorative handles for the integrated drawer front. Keep in mind, there are significant changes to the installation procedure if you plan on using the integrated drawer front.

FEATURES

L Series stainless steel drawer front with handle available in classic, platinum and carbon finishes

E Series stainless steel drawer front with handle available in classic finish

Integrated drawer front allows for custom wood panel application

850-watt heating element

Hidden electronic touch control panel

Preset and variable temperature control

Preset automatic shut-off or extended operation in Sabbath Mode

Stainless steel interior

Rack for stacking food

Removable stainless steel drawer pan

Full-extension, ball bearing drawer glides

CSA certified for US and Canada

CSA approved for outdoor installations



This appliance is certified by Star-K to meet strict religious regulations in conjunction with specific instructions found on www.star-k.org.

WOLF WARRANTY

Wolf products are covered by a two and five year residential warranty (exclusions apply). See warranty details at the end of this guide.

Dimensions in parentheses are in millimeters unless otherwise specified.

WARMING DRAWER FEATURES

Model WWD30
(E Series framed drawer front shown)

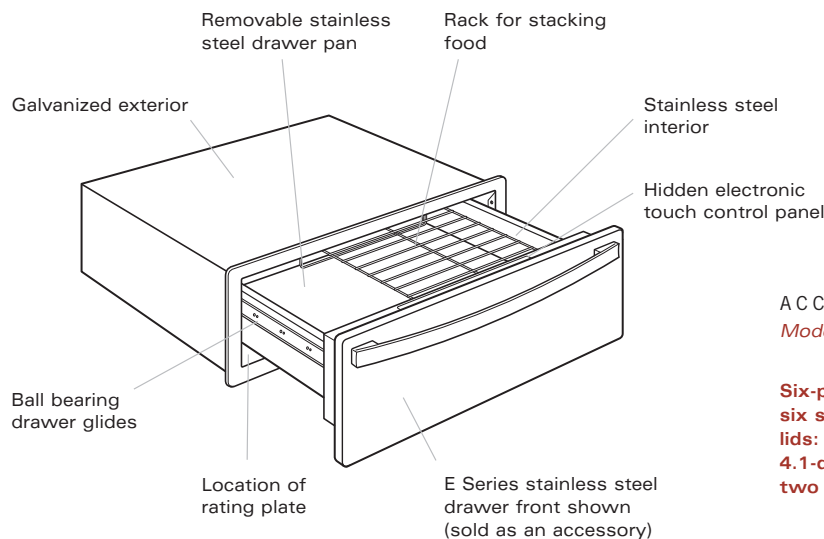

ACCESSORIES

Model WWD30

Six-piece container set—includes six stainless steel pans with lids: one 6.7-quart pan, one 4.1-quart pan, two 3-quart pans, two 1.8-quart pans and pan rack

Accessories are available through your Wolf dealer. To obtain local dealer information, visit the Showroom Locator section of our website, wolfappliance.com.



PLANNING INFORMATION

The Wolf 30" (762) warming drawer is shipped without any decorative drawer front. You must order a L Series or E Series stainless steel drawer front with handle, or the integrated front (no handle) for a custom wood application.

Specifications on the following pages provide overall dimensions, rough openings and installation options for Model WWD30 with L Series and E Series stainless steel and integrated drawer fronts. Note that there are significant differences to the installation requirements for the integrated drawer front.

An anti-tip block or platform must be used to prevent the unit from tipping forward when the drawer is opened.

The base platform must be able to support 200 lbs (91 kg). This platform must be a minimum of 1" (25) above the toe kick to allow for the 5/8" (16) overlap of the warming drawer trim.

Model WWD30 may be installed below a Wolf built-in oven or an electric or gas cooktop, provided the warming drawer is fully enclosed, top and bottom. It may also be installed next to or above another Model WWD30. Dimensions will vary according to the specific installation.

STAINLESS STEEL DRAWER FRONTS

Wolf recommends using a 33" (838) wide cabinet for the warming drawer with the L Series and E Series stainless steel drawer front. A minimum 30" (762) wide by 24" (610) deep cabinet is required.

INTEGRATED DRAWER FRONT

IMPORTANT NOTE: A minimum 33" (838) wide cabinet is required for the warming drawer with integrated drawer front. A minimum 24" (610) deep cabinet is required for an overlay application and 25" (635) deep cabinet for a flush inset application.

Model WWD30 with integrated drawer front can accommodate installations with a 30" (762) or 36" (914) cooktop. It may also be installed in combination with a 30" (762) L Series or E Series single or double oven or a 36" (914) L Series single oven. Dimensions will vary according to the specific installation.

Keep in mind that the width of the custom panel for the warming drawer with integrated drawer front will vary according to the specific installation. The opening width will remain 29 1/2" (749) whether installed in combination with a 30" (762) or 36" (914) cooktop or oven.

The decorative wood drawer front panel must be a minimum of 5/8" (16) thick.

ELECTRICAL REQUIREMENTS

Model WWD30 requires a separate, grounded 120 V AC, 60 Hz power supply. The service should have its own 15 or 20 amp circuit breaker, and a grounded 3-prong receptacle should be located within reach of the power cord and flush with the back wall. Locate electrical within the shaded area shown in the installation illustrations on the following pages.

IMPORTANT NOTE: When installed outdoors, a ground fault circuit interrupter (GFCI) is required to reduce the risk of electrical shock.

ACCESSORIES

Optional accessories are available through your Wolf dealer. To obtain local dealer information, visit the Showroom Locator section of our website, wolfappliance.com.

FRONT PANEL OPTIONS

Model WWD30

L Series Stainless Steel Drawer Front

Classic Finish	WWDFRONT/S
Platinum Finish	WWDFRONT/P
Carbon Finish	WWDFRONT/B

E Series Stainless Steel Drawer Front

Framed – Classic	WWDFRONT-2F/S
Unframed – Classic	WWDFRONT-2U/S

Integrated Drawer Front

Accepts Wood Panel	WWDFRONT/I
--------------------	-------------------

Optional drawer front panels are ordered and shipped as a sales accessory. Stainless steel drawer front panels include handles to match L Series or E Series built-in ovens.



WOLF WARMING DRAWERS

OVERALL DIMENSIONS

Model WWD30 with L Series Drawer Front

SPECIFICATIONS

Model WWD30 with L Series Drawer Front

Overall Width	29⁷/₈" (759)
Overall Height	10¹/₄" (260)
Overall Depth (behind frame)	23¹/₂" (597)
Interior Capacity	1.6 cu ft (45 L)
Cabinet Width	33" (838) rec 30" (762) min
Cabinet Depth	24" (610) min
Min Base Support	200 lbs (91 kg)
Opening Width	28⁵/₈" (727)
Opening Height	9¹/₈" (232)
Opening Depth	23⁷/₈" (606)
Electrical Supply	120 V AC, 60 Hz 15 or 20 amp circuit
Heating Element	850 W
Power Cord	3' (.9 m) 3-prong
Shipping Weight	100 lbs (45 kg)

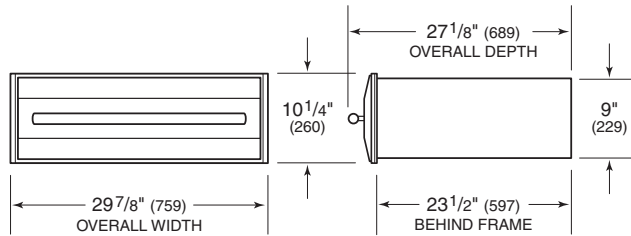

Unit dimensions may vary to ±1/8" (3).

INSTALLATION SPECIFICATIONS

Model WWD30 with L Series Drawer Front

Undercounter Installation

INSTALLATION OPTIONS

Model WWD30 with L Series drawer front may be installed below an induction, electric or gas cooktop, provided the warming drawer is fully enclosed, top and bottom, with a minimum base support of 200 lbs (91 kg). Refer to the cooktop sections for additional specifications.

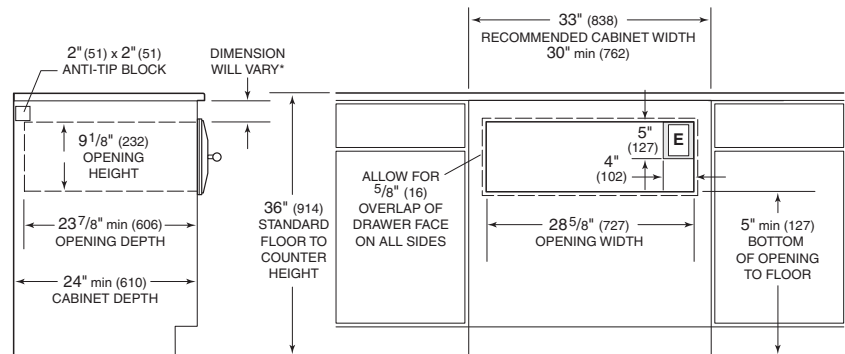

*Allow enough room for placement of anti-tip block and drawer face overlap.

Installation with 30" (762) L Series Single Oven

Model WWD30 with L Series drawer front may be installed above or below a 30" (762) L Series single or double oven provided the warming drawer is fully enclosed, top and bottom, with a minimum base support of 200 lbs (91 kg). Refer to the L Series built-in oven section for additional specifications. It may also be installed next to or above another Model WWD30 with L Series drawer front. Refer to the following pages for additional applications.

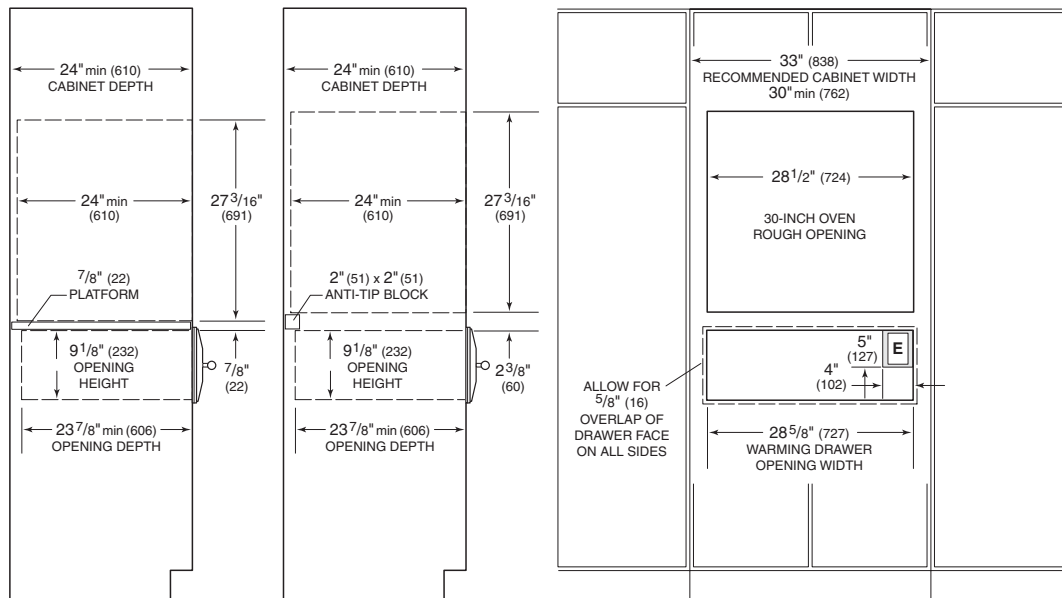

PLATFORM APPLICATION

ANTI-TIP BLOCK APPLICATION

NOTE: Refer to the 30" (762) L Series built-in oven specifications for electrical location

Dimensions in parentheses are in millimeters unless otherwise specified.



OVERALL DIMENSIONS

Model WWD30 with E Series Drawer Front
(E Series unframed drawer front shown)

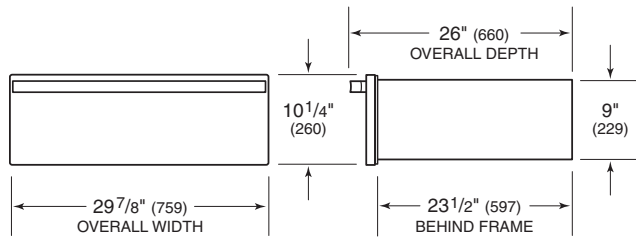

Unit dimensions may vary to ±1/8" (3).

SPECIFICATIONS

Model WWD30 with E Series Drawer Front

Overall Width	29 7/8" (759)
Overall Height	10 1/4" (260)
Overall Depth (behind frame)	23 1/2" (597)
Interior Capacity	1.6 cu ft (45 L)
Cabinet Width	33" (838) rec 30" (762) min
Cabinet Depth	24" (610) min
Min Base Support	200 lbs (91 kg)
Opening Width	28 5/8" (727)
Opening Height	9 1/8" (232)
Opening Depth	23 7/8" (606)
Electrical Supply	120 V AC, 60 Hz 15 or 20 amp circuit
Heating Element	850 W
Power Cord	3' (.9 m) 3-prong
Shipping Weight	100 lbs (45 kg)

INSTALLATION SPECIFICATIONS

Model WWD30 with E Series Drawer Front
Undercounter Installation

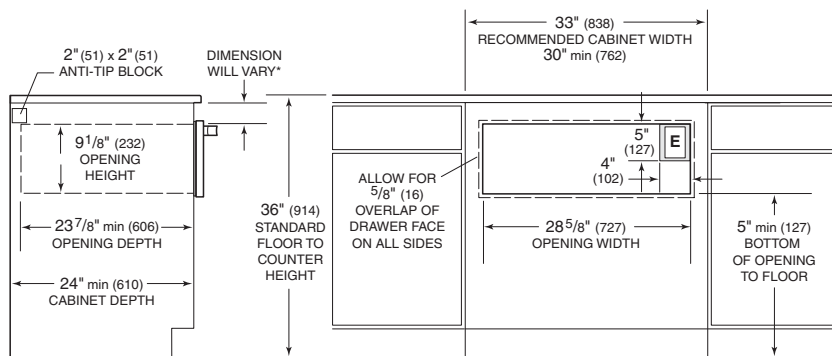

*Allow enough room for placement of anti-tip block and drawer face overlap.

Installation with 30" (762) E Series Single Oven

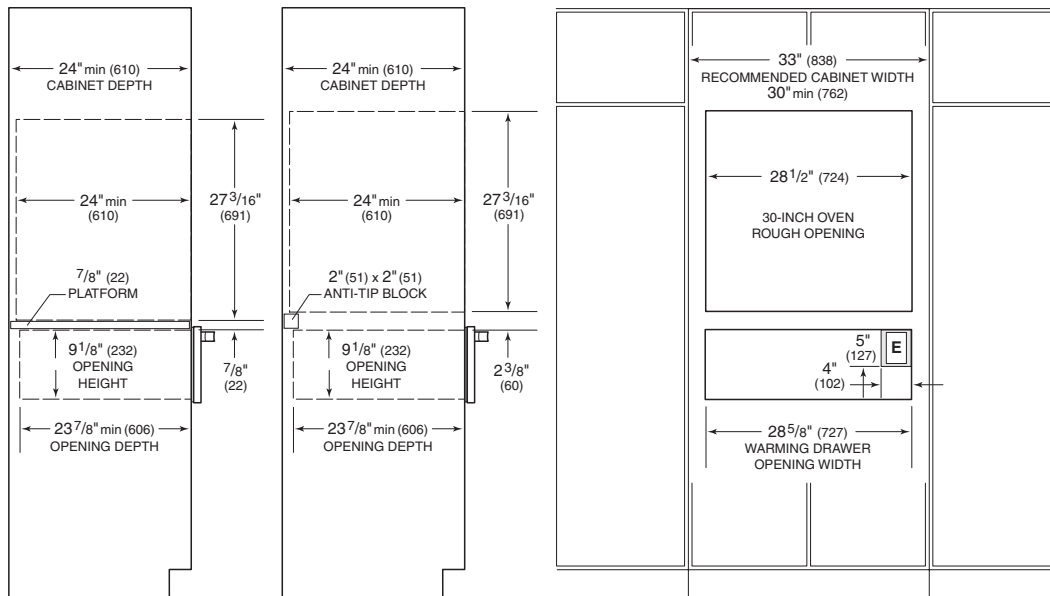

PLATFORM APPLICATION

ANTI-TIP BLOCK APPLICATION

NOTE: Refer to the 30" (762) E Series built-in oven specifications for electrical location.

INSTALLATION OPTIONS

Model WWD30 with E Series drawer front may be installed below an induction, electric or gas cooktop, provided the warming drawer is fully enclosed, top and bottom, with a minimum base support of 200 lbs (91 kg). Refer to the cooktop sections for additional specifications.

Model WWD30 with E Series drawer front may be installed above or below a 30" (762) E Series single or double oven provided the warming drawer is fully enclosed, top and bottom, with a minimum base support of 200 lbs (91 kg). Refer to the E Series built-in oven section for additional specifications. It may also be installed next to or above another Model WWD30 with E Series drawer front. Refer to the following pages for additional applications.

Refer to installation instructions shipped with each Wolf product for detailed specifications.



WOLF WARMING DRAWERS

SPECIFICATIONS

Model WWD30 with Integrated Drawer Front

Overall Width	29³/₈" (746)
Overall Height	10¹/₈" (257)
Overall Depth (behind frame)	23¹/₂" (597)
Interior Capacity	1.6 cu ft (45 L)
Min Cabinet Width	33" (838)
Min Cabinet Depth	
Overlay	24" (610)
Flush Inset	25" (635)
Min Base Support	200 lbs (91 kg)
Opening Width	29¹/₂" (749)
Opening Height	10¹/₄" (260)
Opening Depth*	24" (610)
Min Panel Size (W x H)	
Overlay	30" (762) x 10³/₈" (264)
Flush Inset	29³/₈" (746) x 10¹/₈" (257)
Min Panel Thickness	5/8" (16)
Electrical Supply	120 V AC, 60 Hz 15 or 20 amp circuit
Heating Element	850 W
Power Cord	3' (.9 m) 3-prong
Shipping Weight	100 lbs (45 kg)

*For flush inset application, add thickness of drawer face to opening depth.

OVERALL DIMENSIONS

Model WWD30 with Integrated Drawer Front

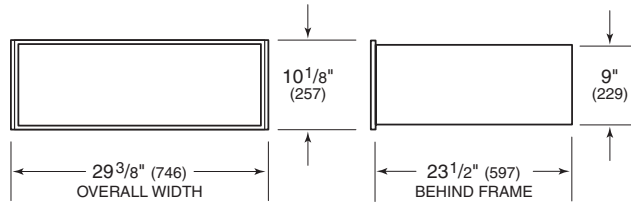

Unit dimensions may vary to ±1/8" (3).

INSTALLATION SPECIFICATIONS

Model WWD30 with Integrated Drawer Front Undercounter Installation

Overlay Application

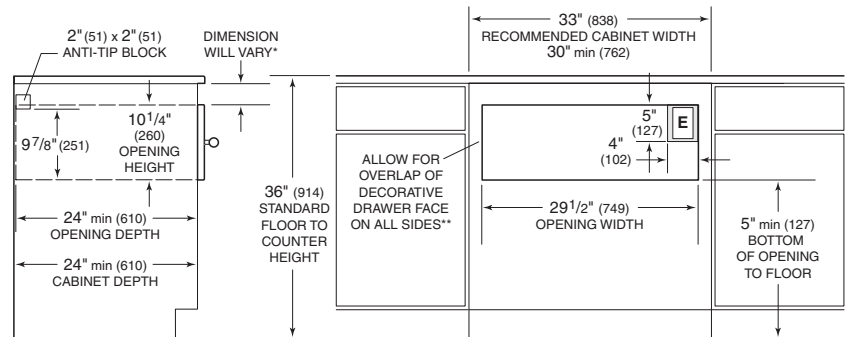

*Allow enough room for placement of anti-tip block and drawer face overlap.

**Overlap of decorative drawer face will vary depending on the size of the custom panel.

INSTALLATION OPTIONS

Model WWD30 with integrated drawer front may be installed below an induction, electric or gas cooktop, provided the warming drawer is fully enclosed, top and bottom, with a minimum base support of 200 lbs (91 kg). Refer to the cooktop sections for additional specifications. It may also be installed next to or above another Model WWD30 with integrated drawer front. Refer to the following pages for additional applications.

Dimensions will vary according to the specific installation.

Flush Inset Application

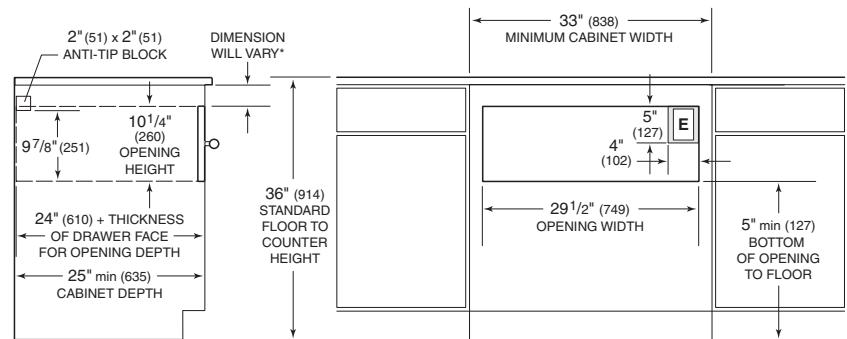

*Allow enough room for placement of anti-tip block.

Dimensions in parentheses are in millimeters unless otherwise specified.



INSTALLATION SPECIFICATIONS

Model WWD30 with Integrated Drawer Front

Installation with 30" (762) L Series or E Series Single Oven

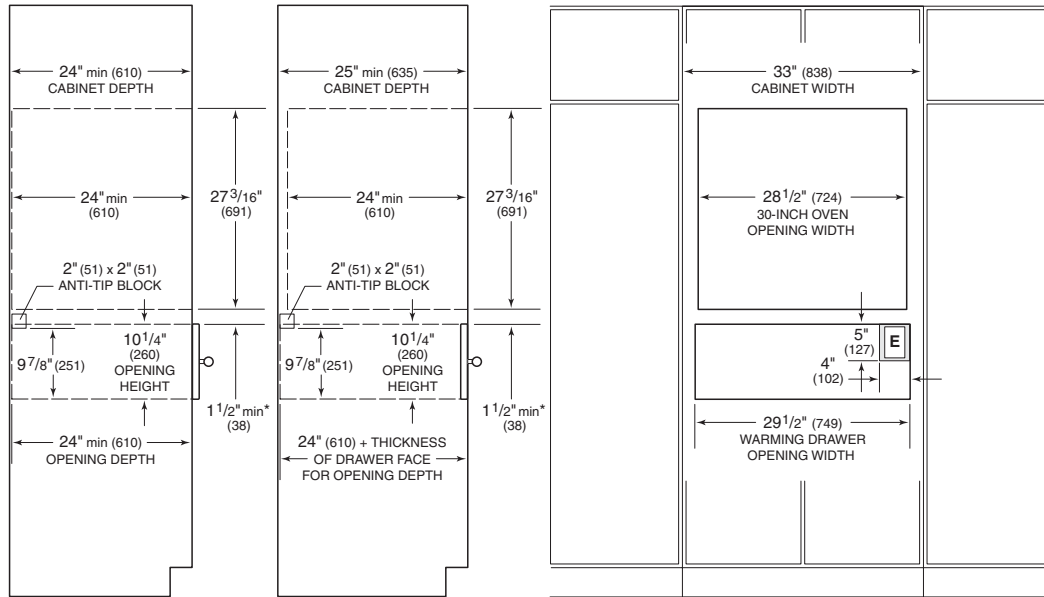

OVERLAY APPLICATION

FLUSH INSET APPLICATION

NOTE: Refer to the built-in 30" (762) single oven specifications for electrical location.

*Dimension may increase depending on the size of the drawer front panel.

INSTALLATION OPTIONS

Model WWD30 with integrated drawer front may be installed above or below any L Series or E Series single or double oven provided the warming drawer is fully enclosed, top and bottom, with a minimum base support of 200 lbs (91 kg). Refer to the oven sections for installation specifications for the built-in oven.

Refer to the installation instructions provided with each microwave trim kit for detailed specifications.

Dimensions will vary according to the specific installation.

Refer to installation instructions shipped with each Wolf product for detailed specifications.



WOLF WARMING DRAWERS

INSTALLATION SPECIFICATIONS

Model WWD30 with L Series Drawer Front

Installation with 30" (762) L Series Single Oven and Model MWC24 with 30" (762) L Series Trim

INSTALLATION OPTIONS

Model WWD30 with L Series drawer front may be installed in combination with a 30" (762) L Series single oven and Model MWC24 with 30" (762) L Series trim. Refer to the L Series built-in oven section for installation specifications for the oven.

Model WWD30 with E Series drawer front may be installed in combination with a 30" (762) E Series single oven and Model MWC24 with 30" (762) E Series trim. Refer to the E Series built-in oven section for installation specifications for the oven.

Refer to the installation instructions provided with each microwave trim kit for detailed specifications.

Dimensions will vary according to the specific installation.

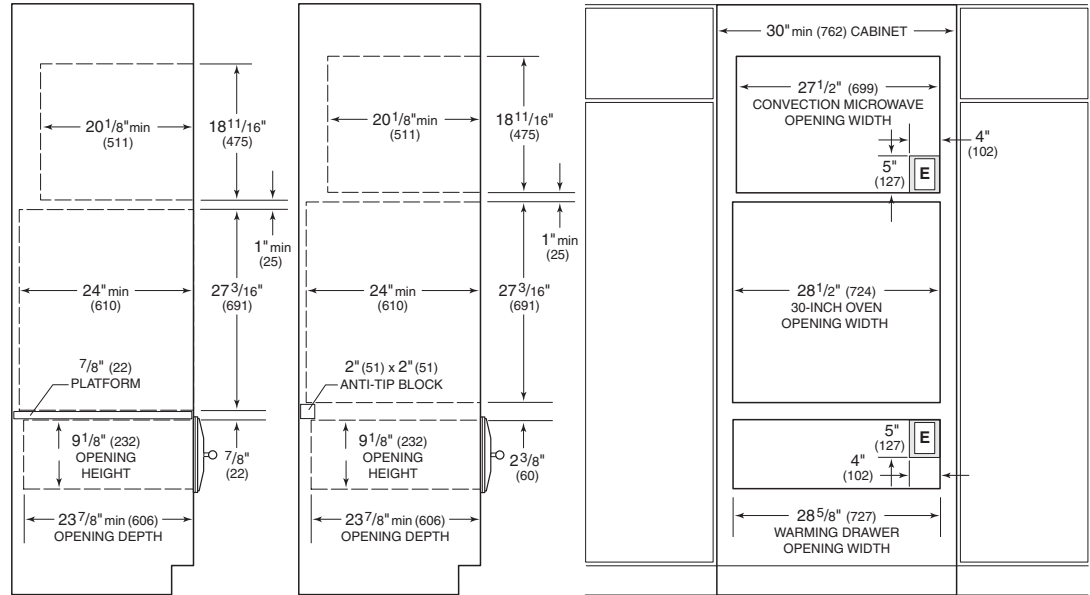

PLATFORM APPLICATION

ANTI-TIP BLOCK APPLICATION

NOTE: Refer to the 30" (762) built-in single oven specifications for electrical location.

INSTALLATION SPECIFICATIONS

Model WWD30 with E Series Drawer Front

Installation with E Series Single Oven and Model MWC24 with 30" (762) E Series Trim

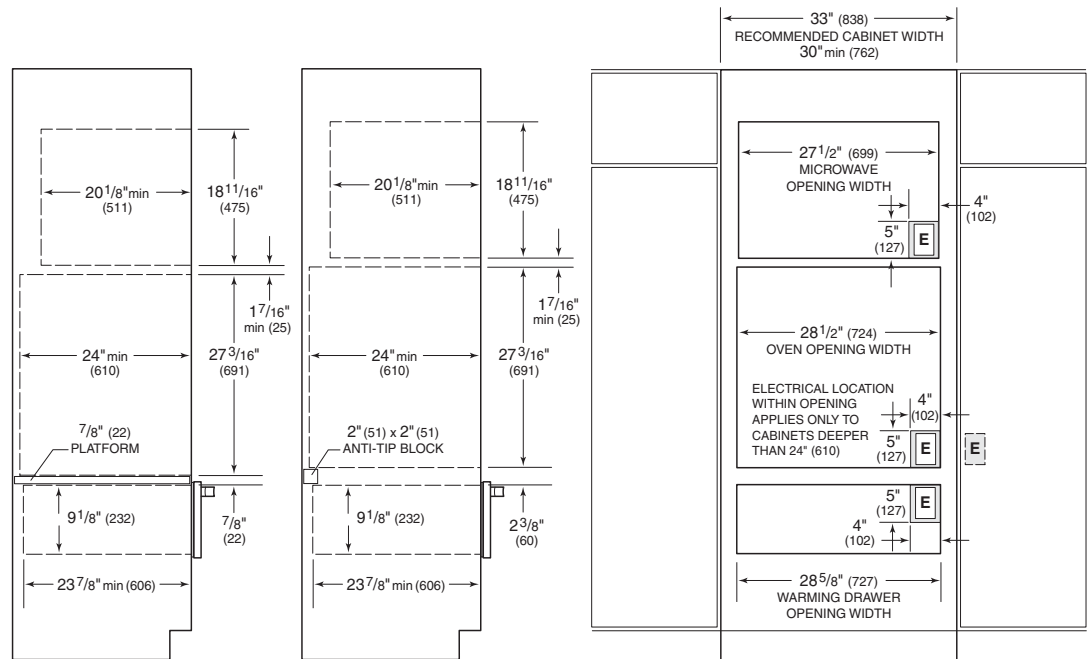

PLATFORM APPLICATION

ANTI-TIP BLOCK APPLICATION

NOTE: Unless you are using cabinets deeper than 24" (610), it is recommended that the electrical supply for the oven be placed in an adjacent cabinet within reach of the conduit.

Dimensions in parentheses are in millimeters unless otherwise specified.



INSTALLATION SPECIFICATIONS

Model WWD30 with Integrated Drawer Front

Installation with 36" (914) L Series Single Oven and Model MWC24 with 36" (914) L Series Trim

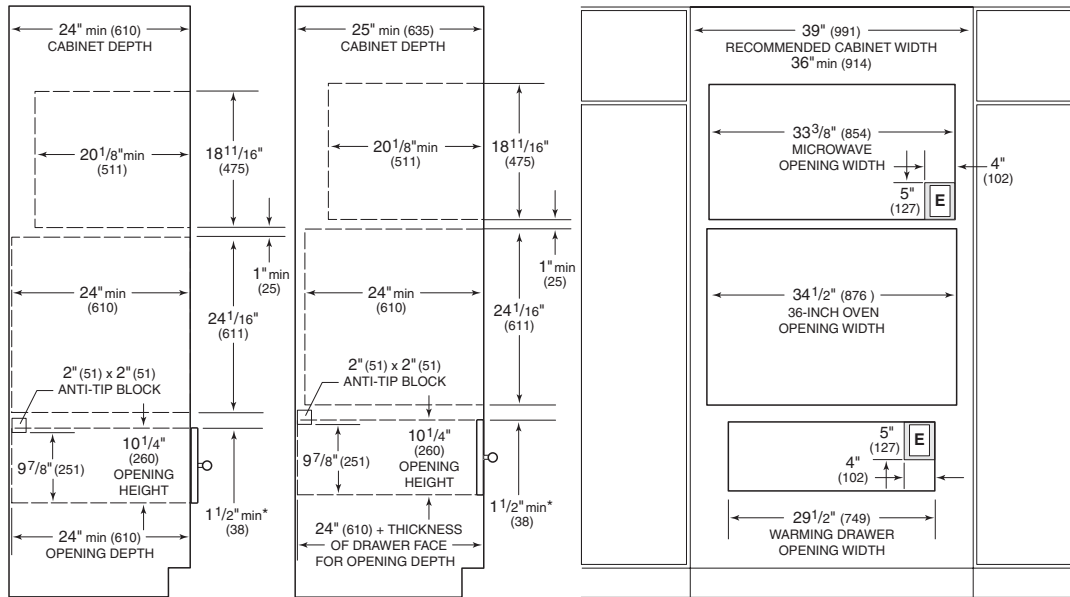

OVERLAY APPLICATION

FLUSH INSET APPLICATION

NOTE: Refer to the 36" (914) built-in single oven specifications for electrical location.

*Dimension may increase depending on the size of the drawer front panel.

The width of the custom panel for the warming drawer with integrated drawer front will vary according to the specific installation, but the rough opening width will remain 29 1/2" (749).

INSTALLATION OPTIONS

Model WWD30 with integrated drawer front may be installed in combination with a 36" (914) L Series single oven and Model MWC24 with 36" (914) L Series trim kit. Refer to the L Series built-in oven section for installation specifications for the oven.

Keep in mind that the width of the custom panel for the warming drawer with integrated drawer front will vary according to the specific installation.

Refer to the installation instructions provided with each microwave trim kit for detailed specifications.

Dimensions will vary according to the specific installation.

Refer to installation instructions shipped with each Wolf product for detailed specifications.



WOLF INDUCTION COOKTOPS

Induction cooking has been used in Europe for decades by professionals and homeowners demanding the best in performance.

In induction cooking, the electricity flows through a coil to produce a magnetic field under the ceramic cooktop.

When a cast iron or magnetic stainless steel pan is placed on the ceramic glass surface, currents are induced in the cooking utensil and instant heat is generated due to the resistance of the pan. Induction only works with cooking vessels made of magnetic materials, such as cast iron and magnetic stainless steel (it will not work with aluminum or copper pots). To test the cookware, a magnet must stick to the bottom of the vessel in order to function.

Induction cooking is so efficient that it outperforms gas and electric cooktops. There is no wasted heat because energy is supplied directly to the cooking vessel, so nearly 90 percent of the energy gets used to cook.

You can keep sauces and chocolates melted at 50 watts of power, or with the touch of a finger, activate the Hi-Power boost feature and boil water in nearly half the time you normally do.

FEATURES

Classic stainless steel trim finish

Easy-to-clean black ceramic glass surface is resistant to scratching, staining, impact and heat

High-efficiency induction elements deliver power and control

Induction elements heat cookware, not the glass, for a cooler, safer cooking surface

Cookware sensing—elements will not be energized without an induction-compatible pan on the cooktop surface

Hi-Power mode boosts power to the element

Temperature limiter to ensure that safe operating temperature of ceramic glass is never exceeded

Illuminated touch controls with graduated control lighting and adjustable sound frequency and volume

Hot-surface indicator light in control panel

Lock mode—cooktop will be locked so that no elements can be turned on

Universal OFF turns all elements off

Countdown timer with 1 to 99 minute range

CSA certified for US and Canada

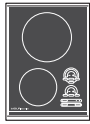

Model CT15I/S
15" (381) Induction Cooktop

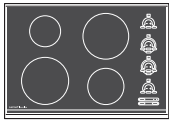

Model CT30I/S
30" (762) Induction Cooktop

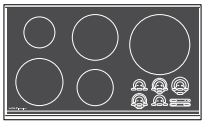

Model CT36I/S
36" (914) Induction Cooktop

WOLF WARRANTY

Wolf products are covered by a two and five year residential warranty (exclusions apply). See warranty details at the end of this guide.

Dimensions in parentheses are in millimeters unless otherwise specified.

INDUCTION COOKTOP FEATURES

Model CT36I/S shown

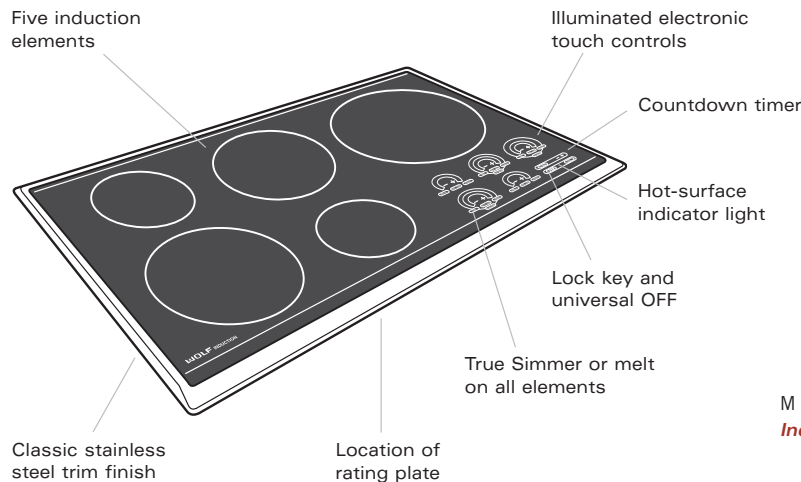

MODEL OPTIONS

Induction Cooktops

15" (381) Induction Cooktop
Classic Trim CT15I/S

30" (762) Induction Cooktop
Classic Trim CT30I/S

36" (914) Induction Cooktop
Classic Trim CT36I/S



PLANNING INFORMATION

You have three different sizes of induction cooktops to choose from and all have the classic stainless steel trim finish.

For ease of installation, Wolf recommends using 33" (838) cabinets with the 30" (762) cooktop and 39" (991) cabinets with the 36" (914) cooktop.

Specifications on the following pages provide overall dimensions, countertop cut-out dimensions and installation specifics for the three different-sized cooktops. We have minimized the information contained in the illustrations, concentrating on the critical information you need to plan your installation.

A Wolf L Series or E Series built-in single oven may be installed below these cooktops. Wolf induction cooktops are designed and agency approved for installation with Wolf built-in ovens only. Also, be aware of the depth of the cooktop when planning for this installation.

IMPORTANT NOTE: When multiple cooktops or modules are installed side by side, refer to page 55 for countertop cut-out dimensions.

These cooktops can accommodate a Wolf cooktop hood, downdraft system or Pro ventilation hood or hood liner. When installing a ventilation hood, refer to the specific requirements of the hood for the minimum dimension to the countertop. Refer to pages 29–114 for ventilation specifications.

ELECTRICAL REQUIREMENTS

The electrical requirements vary with the size of the induction cooktop. Refer to the specifications on the following pages for the three different cooktop sizes. Locate electrical supply within the shaded area shown in the Installation Specifications illustration for your model.

IMPORTANT NOTE: When an oven is installed below the cooktop, it is recommended that the electrical supply be placed in the base cabinet to the right of the oven, unless you are using cabinets deeper than 24" (610). Refer to pages 4–14 for additional specifications for built-in ovens.

You must follow all National Electrical Code regulations. In addition, be aware of local codes and ordinances when installing your service.

⚠ WARNING

These cooktops are intended for indoor use.

ACCESSORIES

Optional accessories are available through your Wolf dealer. To obtain local dealer information, visit the Showroom Locator section of our website, wolfappliance.com.

ACCESSORIES

Induction Cooktops

Filler strip

Bracket supports for installation of two integrated modules with downdraft (Model DD30 only)

Accessories are available through your Wolf dealer. To obtain local dealer information, visit the Showroom Locator section of our website, wolfappliance.com.

This appliance must be installed in accordance with National Electrical Code regulations as well as all state, municipal and local codes. The correct voltage, frequency and amperage must be supplied to the appliance from a dedicated, grounded circuit that is protected by a properly sized circuit breaker or time delay fuse. The proper voltage, frequency and amperage ratings are listed on the product rating plate.



NEW Available October 2007

SPECIFICATIONS

New Model CT15I/S

Trim Finish	Classic
Overall Width	15" (381)
Overall Height	3 1/2" (89)
Overall Depth	21" (533)
Induction Elements	Two
Max Element Power	(1) 1800 W with 3000 W boost, (1) 1200 W
Cabinet Depth	22 3/4" (578) min
Height Clearance	4 1/2" (114) min
Cut-Out Width*	13 3/8" (340)
Cut-Out Depth	19 1/4" (489)
Electrical Supply	240/208 V AC, 50/60 Hz 20 amp circuit
Conduit	4' (1.2 m) flexible 3-wire
Electrical Rating	3.6 kW at 240 V 3.1 kW at 208 V
Shipping Weight	30 lbs (14 kg)

OVERALL DIMENSIONS

New Model CT15I/S

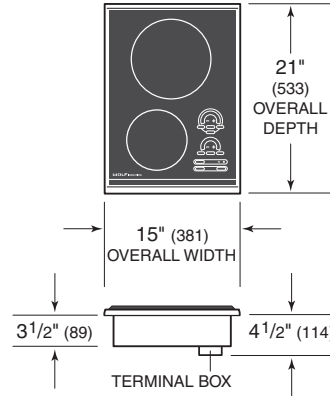

Unit dimensions may vary to ±1/8" (3).

**If the 15" (381) cooktop is to be used with any combination of additional cooktop units or modules with a filler strip, the cut-out width increases to 14" (356).*

The diameter of the induction elements are 8 3/4" (220) and 6 3/4" (171).

IMPORTANT NOTE: A minimum height clearance of 6" (152) is required between countertop and any combustible surface directly below the cooktop.

IMPORTANT NOTE: If a shelf is installed below the cooktop, a 1" (25) gap at the rear of the cabinet shelf is necessary to allow for proper ventilation. Failure to do so could result in decreased performance or product damage.

INSTALLATION SPECIFICATIONS

New Model CT15I/S

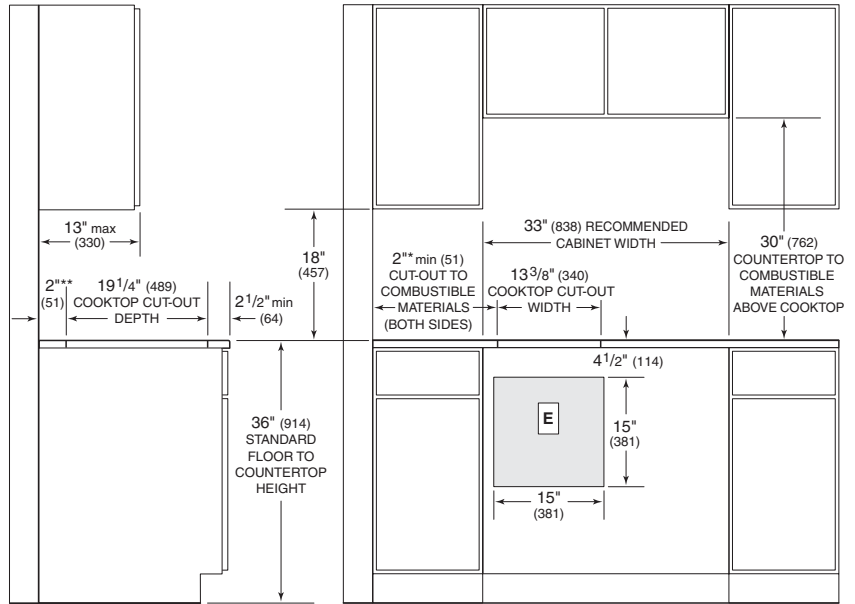

NOTE: Application shown allows for installation of two 15" (381) modules side-by-side with 33" (838) recommended cabinet width. 18" (457) recommended cabinet width for installation of single 15" (381) cooktop or module. *Minimum clearance from both side edges of cooktop cut-out to combustible materials up to 18" (457) above countertop. **Minimum clearance from rear edge of cooktop cut-out to combustible materials up to 18" (457) above countertop.

Countertop Cut-Out Dimensions

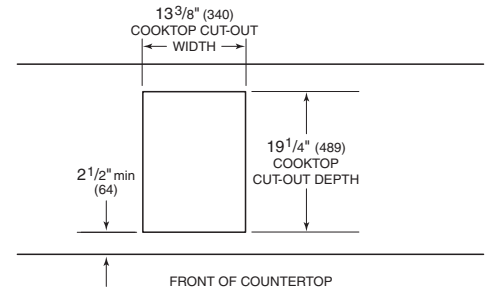

Dimensions in parentheses are in millimeters unless otherwise specified.



OVERALL DIMENSIONS

Model CT30I/S

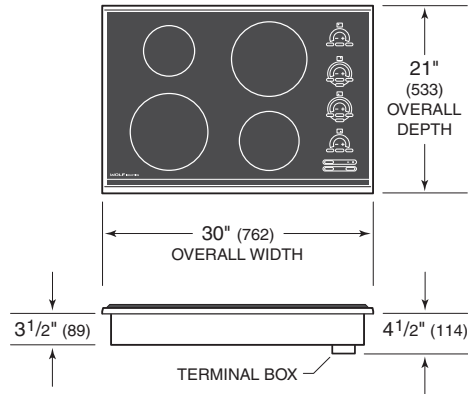

Unit dimensions may vary to ±1/8" (3).

NEW Available October 2007

SPECIFICATIONS

Model CT30I/S

Trim Finish	Classic
Overall Width	30" (762)
Overall Height	3 1/2" (89)
Overall Depth	21" (533)
Induction Elements	Four
Max Element Power	(2) 1800 W with 3000 W boost, (2) 1200 W
Cabinet Width	33" (838) rec 30" (762) min
Cabinet Depth	22 3/4" (578) min
Height Clearance	4 1/2" (114) min
Cut-Out Width*	28 3/8" (721)
Cut-Out Depth	19 1/4" (489)
Electrical Supply	240/208 V AC, 50/60 Hz 40 amp circuit
Conduit	4' (1.2 m) flexible 3-wire
Electrical Rating	7.2 kW at 240 V 6.3 kW at 208 V
Shipping Weight	48 lbs (22 kg)

INSTALLATION SPECIFICATIONS

Model CT30I/S

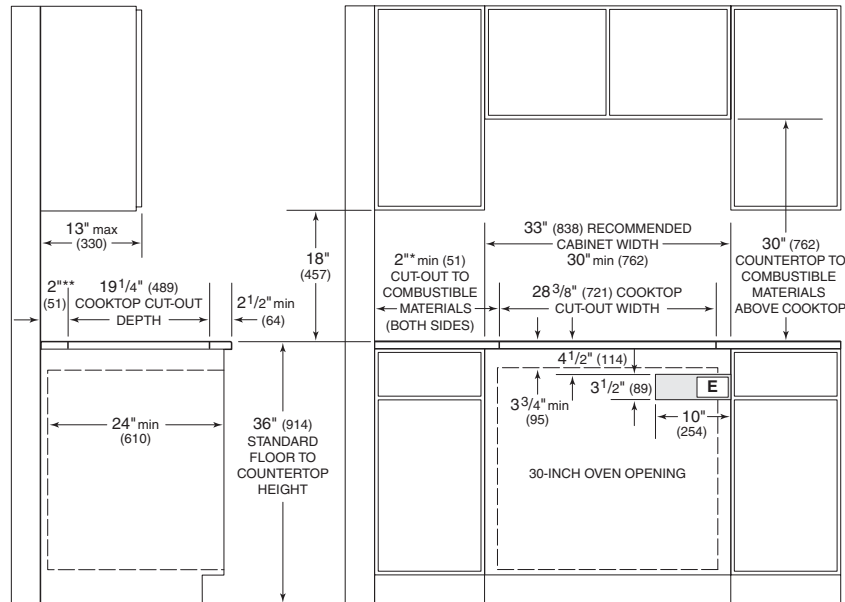

*Minimum clearance from both side edges of cooktop cut-out to combustible materials up to 18" (457) above countertop. **Minimum clearance from rear edge of cooktop cut-out to combustible materials up to 18" (457) above countertop.

Countertop Cut-Out Dimensions

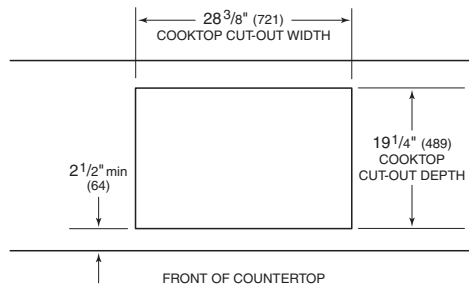

**If the 30" (762) cooktop is to be used with any combination of additional cooktop units or modules with a filler strip, the cut-out width increases to 29" (737).*

The diameter of the induction elements are 5 1/2" (140), 6 3/4" (171) and two 8 3/4" (220).

IMPORTANT NOTE: A minimum height clearance of 6" (152) is required between countertop and any combustible surface directly below the cooktop.

IMPORTANT NOTE: If a shelf is installed below the cooktop, a 1" (25) gap at the rear of the cabinet shelf is necessary to allow for proper ventilation. Failure to do so could result in decreased performance or product damage.

INSTALLATION OPTIONS

A Wolf 30" (762) L Series or E Series single oven may be installed below the 30" (762) induction cooktop. For this installation, unless you are using cabinets deeper than 24" (610), it is recommended that the electrical supply be placed in the base cabinet to the right of the oven. A 36" (914) L Series single oven may also be installed below the 30" (762) induction cooktop. Refer to the built-in ovens section for additional specifications.

Refer to installation instructions shipped with each Wolf product for detailed specifications.



NEW Available October 2007

SPECIFICATIONS

Model CT36I/S

Trim Finish	Classic
Overall Width	36" (914)
Overall Height	3 1/2" (89)
Overall Depth	21" (533)
Induction Elements	Five
Max Element Power	(1) 3000 W with 4000 W boost, (2) 1800 W with 3000 W boost, (2) 1200 W
Cabinet Width	39" (991) rec 36" (914) min
Cabinet Depth	22 3/4" (578) min
Height Clearance	4 1/2" (114) min
Cut-Out Width*	34 3/8" (873)
Cut-Out Depth	19 1/4" (489)
Electrical Supply	240/208 V AC, 50/60 Hz 50 amp circuit
Conduit	4' (1.2 m) flexible 3-wire
Electrical Rating	10.2 kW at 240 V 8.9 kW at 208 V
Shipping Weight	70 lbs (32 kg)

**If the 36" (914) cooktop is to be used with any combination of additional cooktop units or modules with a filler strip, the cut-out width increases to 35" (889).*

The diameter of the induction elements are 5 1/2" (140), 6 3/4" (171), two 8 3/4" (220) and 11" (280).

IMPORTANT NOTE: A minimum height clearance of 6" (152) is required between countertop and any combustible surface directly below the cooktop.

IMPORTANT NOTE: If a shelf is installed below the cooktop, a 1" (25) gap at the rear of the cabinet shelf is necessary to allow for proper ventilation. Failure to do so could result in decreased performance or product damage.

OVERALL DIMENSIONS

Model CT36I/S

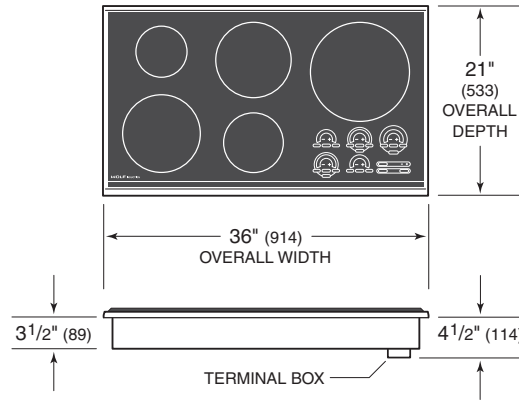

Unit dimensions may vary to ±1/8" (3).

INSTALLATION SPECIFICATIONS

Model CT36I/S

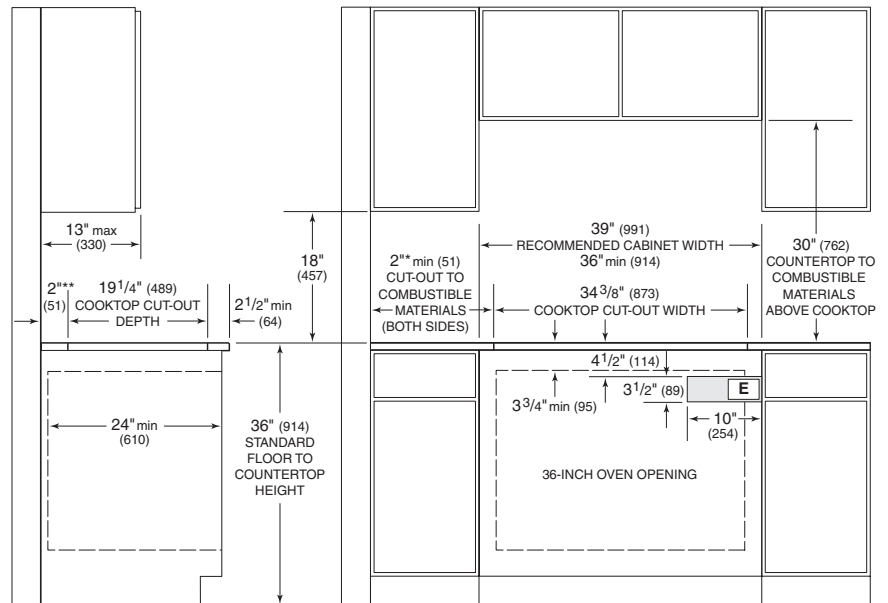

**Minimum clearance from both side edges of cooktop cut-out to combustible materials up to 18" (457) above countertop. **Minimum clearance from rear edge of cooktop cut-out to combustible materials up to 18" (457) above countertop.*

INSTALLATION OPTIONS

A Wolf 36" (914) L Series single oven may be installed below the 36" (914) induction cooktop. For this installation, unless you are using cabinets deeper than 24" (610), it is recommended that the electrical supply be placed in the base cabinet to the right of the oven. A 30" (762) L Series or E Series single oven may also be installed below the 36" (914) induction cooktop. Refer to the built-in ovens section for additional specifications.

When a 36" (914) L Series oven is installed below a cooktop, it is recommended that the rough opening for the oven be 7 3/4" (197) from the floor to ease use of the oven door.

Countertop Cut-Out Dimensions

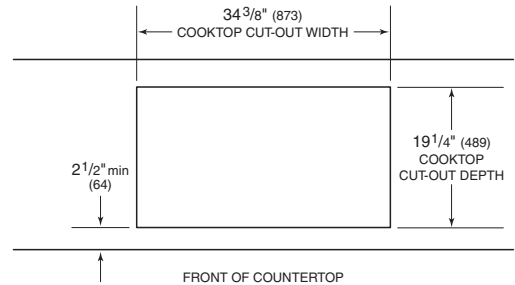



OVERALL DIMENSIONS

Model CT15I/S

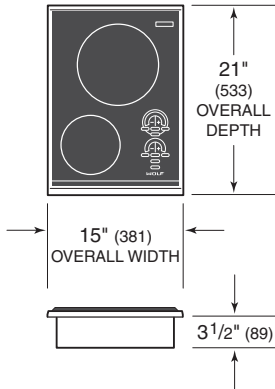

Unit dimensions may vary to ±1/8" (3).

INSTALLATION SPECIFICATIONS

Model CT15I/S

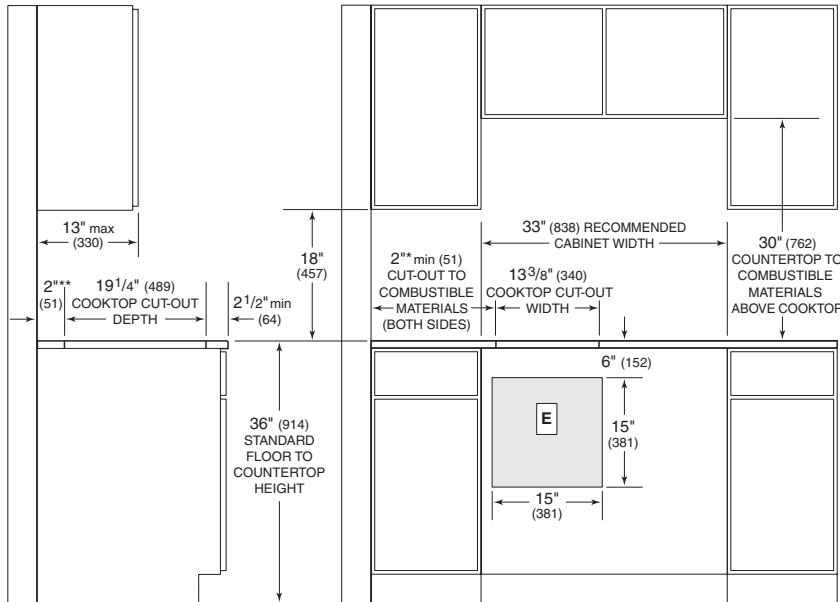

NOTE: Application shown allows for installation of two 15" (381) modules side-by-side with 33" (838) recommended cabinet width. 18" (457) recommended cabinet width for installation of single 15" (381) cooktop or module. *Minimum clearance from both side edges of cooktop cut-out to combustible materials up to 18" (457) above countertop. **Minimum clearance from rear edge of cooktop cut-out to combustible materials up to 18" (457) above countertop.

Countertop Cut-Out Dimensions

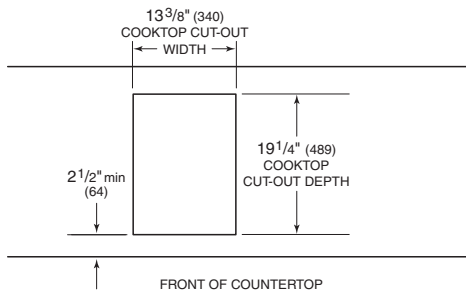

Refer to installation instructions shipped with each Wolf product for detailed specifications.

Discontinued after October 2007

SPECIFICATIONS

Model CT15I/S

Trim Finish	Classic
Overall Width	15" (381)
Overall Height	2 1/2" (64)
Overall Depth	21" (533)
Induction Elements	Two
Max Element Power (front)	1800 W
Max Element Power (rear)	2200 W
Cabinet Depth	22 3/4" (578) min
Height Clearance	6" (152) min
Cut-Out Width*	13 3/8" (340)
Cut-Out Depth	19 1/4" (489)
Electrical Supply	240/208 V AC, 60 Hz 20 amp circuit
Conduit	4' (1.2 m) flexible 3-wire
Electrical Rating	3.4 kW at 240 V 2.6 kW at 208 V
Shipping Weight	30 lbs (14 kg)

*If the induction cooktop is to be used with any combination of additional cooktop units or modules with a filler strip, the cut-out width increases to 14" (356).

IMPORTANT NOTE: A minimum height clearance of 6" (152) is required. If a shelf is installed below the unit, a 1" (25) gap at the rear of the cabinet shelf is necessary to allow for proper ventilation. Failure to do so could result in decreased performance or product damage.



WOLF FRAMED ELECTRIC COOKTOPS

New framed electric cooktop models will be available in November 2007. These new models will replace the existing cooktop models. New model specifications are found on pages 38-40.

The black ceramic glass top of the Wolf framed electric cooktops is beautifully complemented by the classic stainless steel trim finish, and for the 30" (762) and 36" (914) cooktops, you can choose the premium finishes of platinum or carbon stainless steel. The 15" (381) cooktop is available only in the classic stainless steel finish.

All models feature multiple cooking elements with different zones—concentric rings that give you exceptional control of temperature for pots and pans of every size. New models offer a bridge that connects two elements for an 8-inch by 17-inch, 4400 watt heating area.

All of the heating elements offer True Simmer, and with each cooktop there is one element that enables you to set a temperature for melting.



New Model CT15E 15" (381) Framed Electric Cooktop

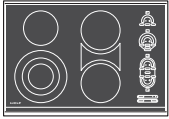

New Model CT30E 30" (762) Framed Electric Cooktop



New Model CT36E 36" (914) Framed Electric Cooktop



This appliance is certified by Star-K to meet strict religious regulations in conjunction with specific instructions found on www.star-k.org.

FEATURES

Classic, platinum and carbon stainless steel trim finishes—Model CT15E in classic stainless only

Easy-to-clean black ceramic glass surface is resistant to scratching, staining, impact and heat—translucent surface allows you to see the glow of hot elements

High-frequency pulsation elements improve cooking performance and control

Bridge-zone element connects two elements to provide a larger cooking area—new 30" (762) and 36" (914) models only

Temperature limiter to ensure that safe operating temperature of ceramic glass is never exceeded

Illuminated touch controls with graduated control lighting

True Simmer setting on all elements

Melt setting on one element

Hot-surface indicator light in control panel

Lock mode—cooktop can be locked so that no elements can be turned on

Universal OFF turns all elements off

Countdown timer with 1 to 99 minute range and adjustable sound frequency and volume—new models only

CSA certified for US and Canada

WOLF WARRANTY

Wolf products are covered by a two and five year residential warranty (exclusions apply). See warranty details at the end of this guide.

Dimensions in parentheses are in millimeters unless otherwise specified.

FRAMED ELECTRIC COOKTOP FEATURES

New Model CT36E shown (features vary with existing models)

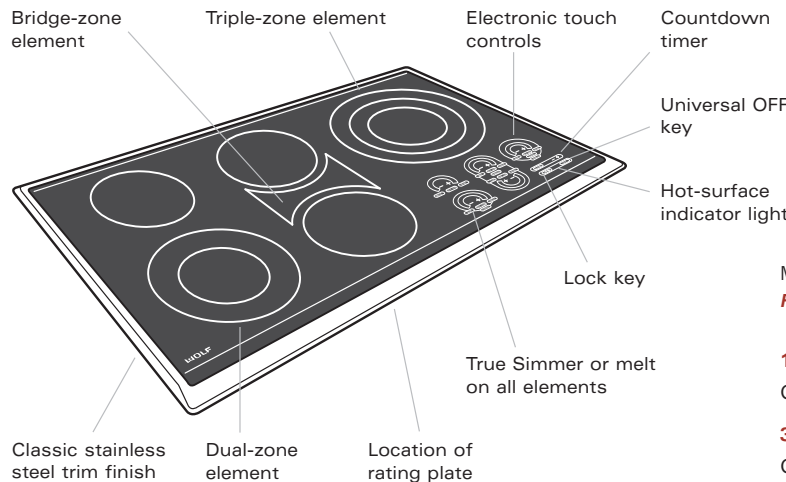

MODEL OPTIONS

Framed Electric Cooktops

15" (381) Framed Electric Cooktop
Classic Trim CT15E/S

30" (762) Framed Electric Cooktop
Classic Trim CT30E/S
CT30E-208/S
Platinum Trim CT30E/P
Carbon Trim CT30E/B

36" (914) Framed Electric Cooktop
Classic Trim CT36E/S
Platinum Trim CT36E/P
Carbon Trim CT36E/B

Stainless steel trim finishes.



PLANNING INFORMATION

From a planning perspective, your selection process is made easier by the three different sizes you have to choose from. The 30" (762) and 36" (914) framed electric cooktops are available in three trim finishes—classic, platinum and carbon stainless steel. The 15" (381) cooktop is available with classic stainless steel trim only.

For ease of installation, Wolf recommends using 33" (838) cabinets with the 30" (762) cooktop and 39" (991) cabinets with the 36" (914) cooktop.

Specifications on the following pages provide overall dimensions, countertop cut-out dimensions and installation specifics for the three different-sized cooktops. We have minimized the information contained in the illustrations, concentrating on the critical information you need to plan your installation.

A Wolf L Series or E Series built-in single oven may be installed below these cooktops. Wolf framed electric cooktops are designed and agency approved for installation with Wolf built-in ovens only. Also, be aware of the depth of the cooktop when planning for this installation.

Multiple cooktops and/or integrated modules can be installed side by side. Refer to the countertop cut-out dimensions on page 55 when planning for this installation.

These cooktops can accommodate a Wolf cooktop hood, downdraft system or Pro ventilation hood or hood liner. When installing a ventilation hood, refer to the specific requirements of the hood for the minimum dimension to the countertop. Refer to pages 92–114 for ventilation specifications.

ACCESSORIES

Electric Cooktops

Filler strip

Bracket supports for installation of two integrated modules with downdraft (Model DD30 only)

Accessories are available through your Wolf dealer. To obtain local dealer information, visit the Showroom Locator section of our website, wolfappliance.com.

ELECTRICAL REQUIREMENTS

The electrical requirements vary with the size of the framed electric cooktop. Refer to the specifications on the following pages for the three different cooktop sizes. Locate electrical supply within the shaded area shown in the Installation Specifications illustration for your model.

IMPORTANT NOTE: When an oven is installed below the cooktop, it is recommended that the electrical supply be placed in the base cabinet to the right of the oven, unless you are using cabinets deeper than 24" (610). Refer to pages 4–14 for additional specifications for built-in ovens.

You must follow all National Electrical Code regulations. In addition, be aware of local codes and ordinances when installing your service.

⚠ WARNING

These cooktops are intended for indoor use.

ACCESSORIES

Optional accessories are available through your Wolf dealer. To obtain local dealer information, visit the Showroom Locator section of our website, wolfappliance.com.

This appliance must be installed in accordance with National Electrical Code regulations as well as all state, municipal and local codes. The correct voltage, frequency and amperage must be supplied to the appliance from a dedicated, grounded circuit that is protected by a properly sized circuit breaker or time delay fuse. The proper voltage, frequency and amperage ratings are listed on the product rating plate.



NEW Available November 2007

SPECIFICATIONS

New Model CT15E/S

Trim Finish	Classic
Overall Width	15" (381)
Overall Height	3³/₄" (96)
Overall Depth	21" (533)
Heating Elements	Two
Temperature Zones	Four
Max Element Power	
Triple	900 / 1800 / 2500 W
Single	1200 W
Cabinet Depth	22³/₄" (578) min
Height Clearance	4" (102) min
Cut-Out Width*	13³/₈" (340)
Cut-Out Depth	19¹/₄" (489)
Electrical Supply	240 V AC / 60 Hz / 20 amp 208 V AC / 60 Hz / 15 amp
Conduit	4' (1.2 m) flexible 3-wire
Electrical Rating	3.7 kW at 240 V 2.8 kW at 208 V
Shipping Weight	30 lbs (14 kg)

**If the 15" (381) cooktop is to be used with any combination of additional cooktop units or modules with a filler strip, the cut-out width increases to 14" (356).*

The outer diameter of the heating elements are 10" (254) and 6¹/₂" (165).

IMPORTANT NOTE: A minimum height clearance of 5³/₄" (146) is required between countertop and any combustible surface directly below the cooktop.

OVERALL DIMENSIONS

New Model CT15E/S

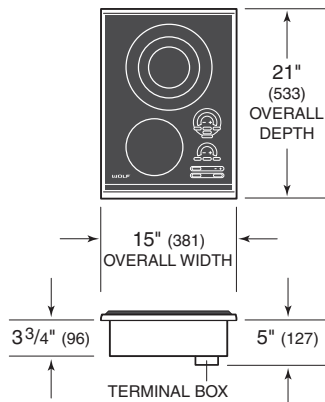

Unit dimensions may vary to ±1/8" (3).

INSTALLATION SPECIFICATIONS

New Model CT15E/S

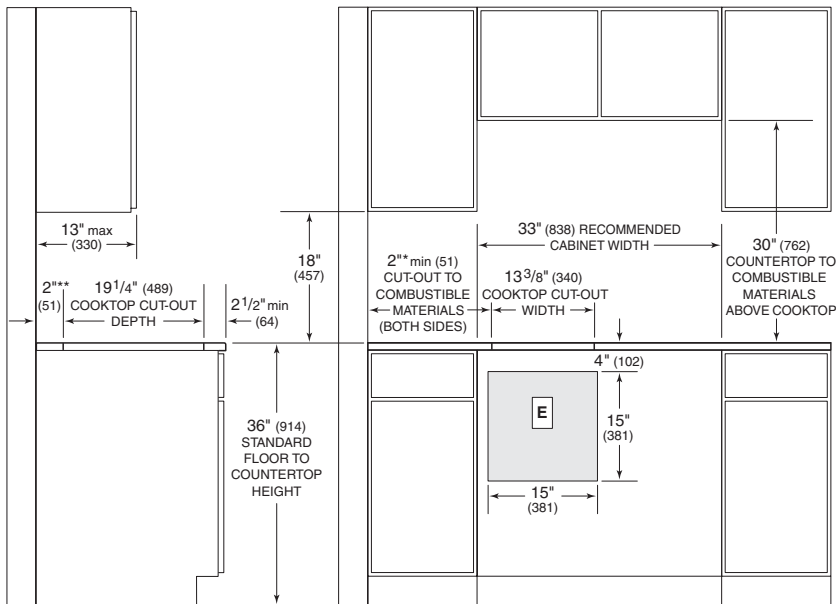

NOTE: Application shown allows for installation of two 15" (381) modules side-by-side with 33" (838) recommended cabinet width. 18" (457) recommended cabinet width for installation of single 15" (381) cooktop or module. *Minimum clearance from both side edges of cooktop cut-out to combustible materials up to 18" (457) above countertop. **Minimum clearance from rear edge of cooktop cut-out to combustible materials up to 18" (457) above countertop.

Countertop Cut-Out Dimensions

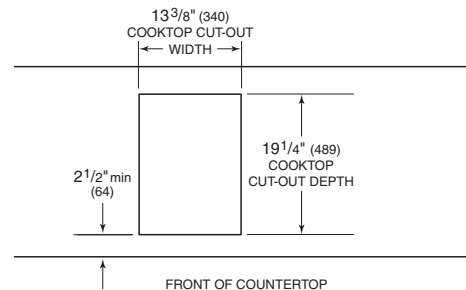

Dimensions in parentheses are in millimeters unless otherwise specified.



OVERALL DIMENSIONS

New Model CT30E

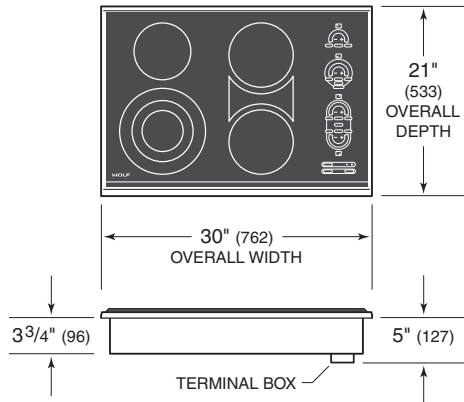

Unit dimensions may vary to ±1/8" (3).

INSTALLATION SPECIFICATIONS

30" (762) Framed Electric Cooktop

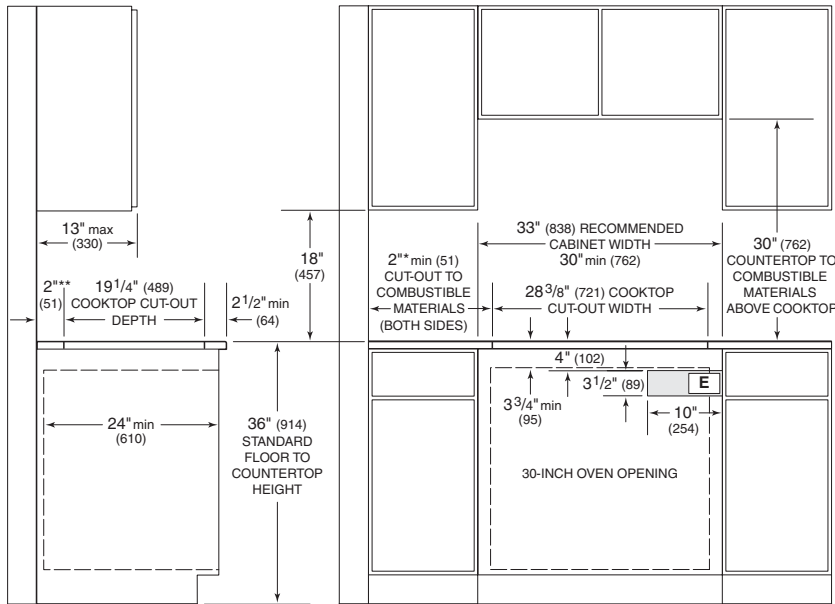

*Minimum clearance from both side edges of cooktop cut-out to combustible materials up to 18" (457) above countertop. **Minimum clearance from rear edge of cooktop cut-out to combustible materials up to 18" (457) above countertop.

Countertop Cut-Out Dimensions

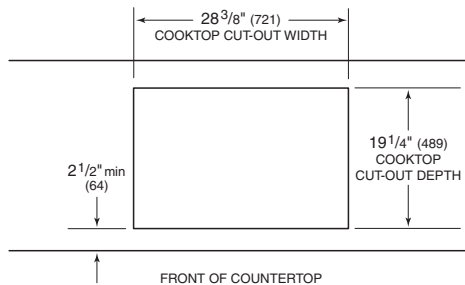

Refer to installation instructions shipped with each Wolf product for detailed specifications.

NEW Available November 2007

MODEL OPTIONS

30" (762) Framed Electric Cooktop

- Classic Trim Finish CT30E/S
CT30E-208/S*
- Platinum Trim Finish CT30E/P
- Carbon Trim Finish CT30E/B

*Model CT30E-208/S is design specifically for use with a 208 V AC, 60 Hz, 40 amp electrical supply.

SPECIFICATIONS

New Model CT30E

Overall Width	30" (762)
Overall Height	3 3/4" (96)
Overall Depth	21" (533)
Heating Elements	Three
Temperature Zones	Four
Max Element Power	
Triple (CT30E-280/S)	900 / 1800 / 2500 W
Singles	900 / 1800 / 2300 W
Singles with Bridge	1200 W and (2) 1800 W
	4400 W
Cabinet Width	33" (838) rec 30" (762) min
Cabinet Depth	22 3/4" (578) min
Height Clearance	4" (102) min
Cut-Out Width*	28 3/8" (721)
Cut-Out Depth	19 1/4" (489)
Electrical Supply	240 V AC / 60 Hz / 40 amp 208 V AC / 60 Hz / 30 amp (CT30E-280/S) 208 V AC / 60 Hz / 40 amp
Conduit	4' (1.2 m) flexible 3-wire
Electrical Rating	8.1 kW at 240 V 6.1 kW at 208 V (CT30E-280/S) 7.9 kW at 208 V
Shipping Weight	45 lbs (20 kg)

*If the 30" (762) cooktop is to be used with any combination of additional cooktop units or modules with a filler strip, the cut-out width increases to 29" (737).

The outer diameter of the heating elements are 10" (254), two 8" (203) and 6 1/2" (165). The bridge with elements is 8" (203) x 17" (432).

IMPORTANT NOTE: A minimum height clearance of 5 3/4" (146) is required between countertop and any combustible surface directly below the cooktop.

INSTALLATION OPTIONS

A Wolf 30" (762) L Series or E Series single oven may be installed below the 30" (762) framed electric cooktop. For this installation, unless you are using cabinets deeper than 24" (610), it is recommended that the electrical supply be placed in the base cabinet to the right of the oven. A 36" (914) L Series single oven may also be installed below the 30" (762) framed electric cooktop. Refer to the built-in 39 ovens section for additional specifications.



WOLF ELECTRIC COOKTOPS

NEW Available November 2007

MODEL OPTIONS

36" (914) Framed Electric Cooktop

- Classic Trim Finish **CT36E/S**
- Platinum Trim Finish **CT36E/P**
- Carbon Trim Finish **CT36E/B**

SPECIFICATIONS

New Model CT36E

- Overall Width **36" (914)**
- Overall Height **3³/₄" (96)**
- Overall Depth **21" (533)**
- Heating Elements **Four**
- Temperature Zones **Five**
- Max Element Power
 - Triple **1050 / 2200 / 2700 W**
 - Dual **700 / 2200 W**
 - Singles **1200 W and (2) 1800 W**
 - Singles with Bridge **4400 W**
- Cabinet Width **39" (991) rec**
36" (914) min
- Cabinet Depth **22³/₄" (578) min**
- Height Clearance **4" (102) min**
- Cut-Out Width* **34³/₈" (873)**
- Cut-Out Depth **19¹/₄" (489)**
- Electrical Supply **240 V AC / 60 Hz / 50 amp**
208 V AC / 60 Hz / 40 amp
- Conduit **4' (1.2 m) flexible 3-wire**
- Electrical Rating **10.5 kW at 240 V**
7.9 kW at 208 V
- Shipping Weight **60 lbs (27 kg)**

**If the 36" (914) cooktop is to be used with any combination of additional cooktop units or modules with a filler strip, the cut-out width increases to 35" (889).*

The outer diameter of the heating elements are 12" (305), 9" (229), two 8" (203) and 6¹/₂" (165). The bridge with elements is 8" (203) x 17" (432).

IMPORTANT NOTE: A minimum height clearance of 5³/₄" (146) is required between countertop and any combustible surface directly below cooktop.

OVERALL DIMENSIONS

New Model CT36E

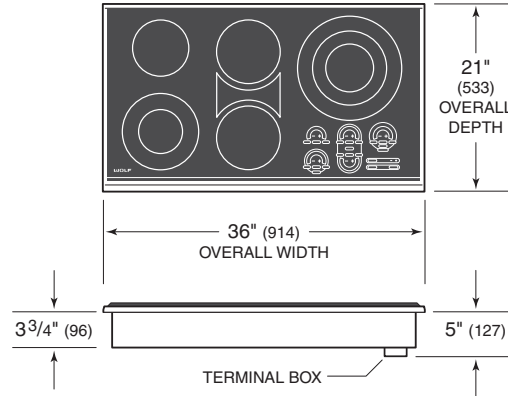

Unit dimensions may vary to ±1/8" (3).

INSTALLATION SPECIFICATIONS

36" (914) Framed Electric Cooktop

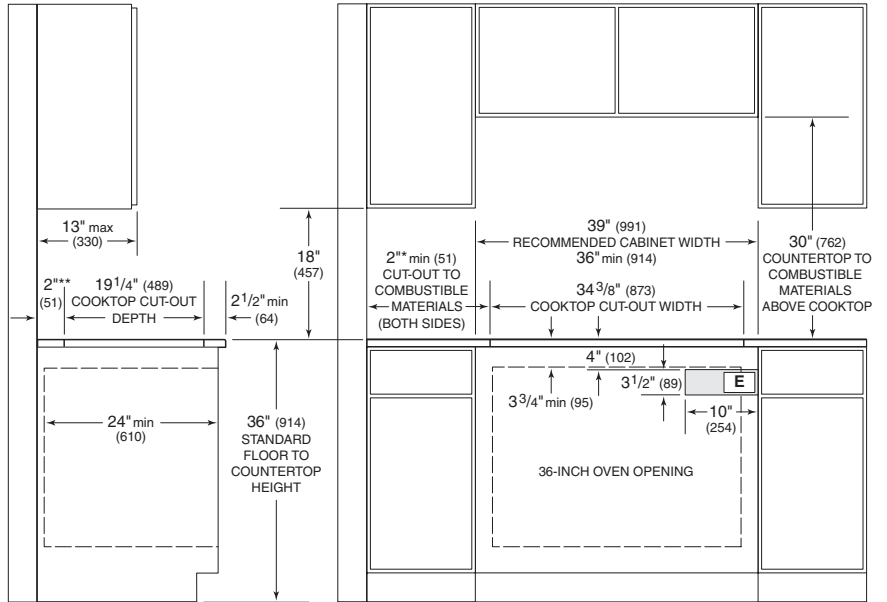

**Minimum clearance from both side edges of cooktop cut-out to combustible materials up to 18" (457) above countertop. **Minimum clearance from rear edge of cooktop cut-out to combustible materials up to 18" (457) above countertop.*

INSTALLATION OPTIONS

A Wolf 36" (914) L Series single oven may be installed below the 36" (914) framed electric cooktop. For this installation, unless you are using cabinets deeper than 24" (610), it is recommended that the electrical supply be placed in the base cabinet to the right of the oven. A Wolf 30" (762) L Series or E Series single oven may also be installed below the 36" (914) framed electric cooktop. Refer to the built-in ovens section for additional specifications.

When a 36" (914) L Series oven is installed below a cooktop, it is recommended that the rough opening for the oven be 7³/₄" (197) from the floor to ease use of the oven door.

Countertop Cut-Out Dimensions

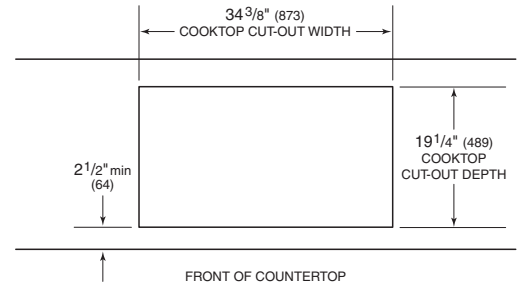



OVERALL DIMENSIONS

Model CT15E/S

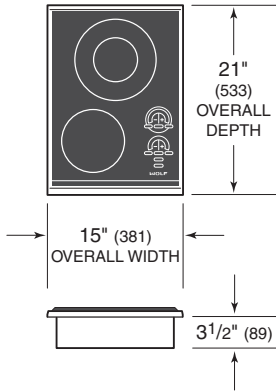

Unit dimensions may vary to ±1/8" (3).

Discontinued November 2007

SPECIFICATIONS

Model CT15E/S

Trim Finish	Classic
Overall Width	15" (381)
Overall Height	3 1/2" (89)
Overall Depth	21" (533)
Heating Elements	Two
Temperature Zones	Three
Max Element Power (dual)	750 W / 2200 W
Max Element Power (single)	1200 W
Cabinet Depth	22 3/4" (578) min
Height Clearance	4" (102) min
Cut-Out Width*	13 3/8" (340)
Cut-Out Depth	19 1/4" (489)
Electrical Supply	240/208 V AC, 60 Hz 15 amp circuit
Conduit	4' (1.2 m) flexible 3-wire
Electrical Rating	3.4 kW at 240 V 2.6 kW at 208 V
Shipping Weight	30 lbs (14 kg)

INSTALLATION SPECIFICATIONS

Model CT15E/S

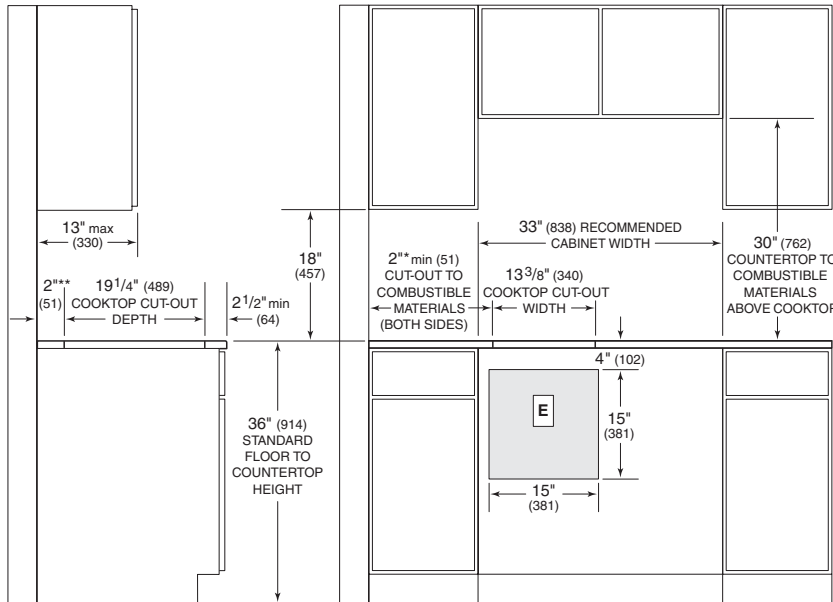

*If the 15" (381) cooktop is to be used with any combination of additional cooktop units or modules with a filler strip, the cut-out width increases to 14" (356).

The outer diameter of the heating elements are 9" (229) and 6 1/2" (165).

NOTE: Application shown allows for installation of two 15" (381) modules side-by-side with 33" (838) recommended cabinet width. 18" (457) recommended cabinet width for installation of single 15" (381) cooktop or module. *Minimum clearance from both side edges of cooktop cut-out to combustible materials up to 18" (457) above countertop. **Minimum clearance from rear edge of cooktop cut-out to combustible materials up to 18" (457) above countertop.

Countertop Cut-Out Dimensions

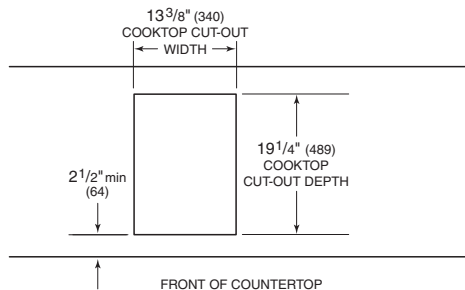

Refer to installation instructions shipped with each Wolf product for detailed specifications.



WOLF ELECTRIC COOKTOPS

Discontinued November 2007

MODEL OPTIONS

30" (762) Framed Electric Cooktop

Classic Trim Finish **CT30E/S**

Platinum Trim Finish **CT30E/P**

Carbon Trim Finish **CT30E/B**

SPECIFICATIONS

Model CT30E

Overall Width	30" (762)
Overall Height	3 1/2" (89)
Overall Depth	21" (533)
Heating Elements	Four
Temperature Zones	Six
Max Element Power (two dual)	750 W / 2200 W and 950 W / 1900 W
Max Element Power (two single)	1200 W and 1500 W
Cabinet Width	33" (383) rec 30" (762) min
Cabinet Depth	22 3/4" (578) min
Height Clearance	4" (102) min
Cut-Out Width*	28 3/8" (721)
Cut-Out Depth	19 1/4" (489)
Electrical Supply	240 V AC / 60 Hz / 40 amp 208 V AC / 60 Hz / 30 amp
Conduit	4' (1.2 m) flexible 3-wire
Electrical Rating	6.8 kW at 240 V 5.2 kW at 208 V
Shipping Weight	45 lbs (20 kg)

**If the 30" (762) cooktop is to be used with any combination of additional cooktop units or modules with a filler strip, the cut-out width increases to 29" (737).*

The outer diameter of the heating elements are 9" (229), 8 1/2" (216), 7" (179) and 6 1/2" (165).

INSTALLATION OPTIONS

A Wolf 30" (762) L Series or E Series single oven may be installed below the 30" (762) framed electric cooktop. For this installation, unless you are using cabinets deeper than 24" (610), it is recommended that the electrical supply be placed in the base cabinet to the right of the oven. A 36" (914) L Series single oven may also be installed below the 30" (762) framed electric cooktop. Refer to the built-in ovens section for additional specifications.

Dimensions in parentheses are in millimeters unless otherwise specified.

OVERALL DIMENSIONS

Model CT30E

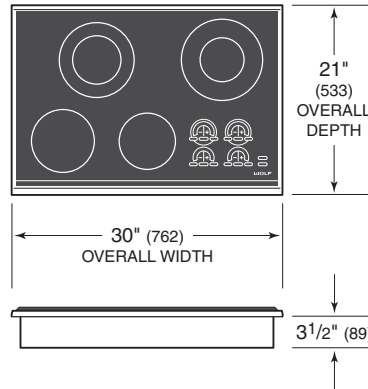

Unit dimensions may vary to ±1/8" (3).

INSTALLATION SPECIFICATIONS

30" (762) Framed Electric Cooktop

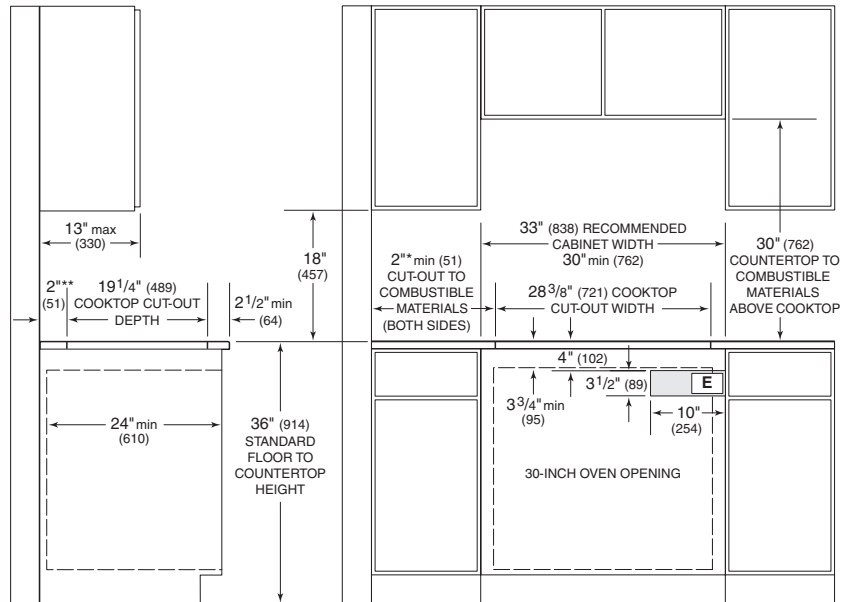

**Minimum clearance from both side edges of cooktop cut-out to combustible materials up to 18" (457) above countertop. **Minimum clearance from rear edge of cooktop cut-out to combustible materials up to 18" (457) above countertop.*

Countertop Cut-Out Dimensions

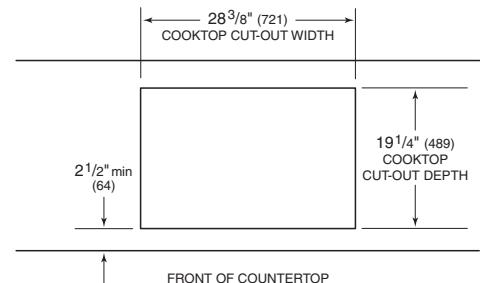



OVERALL DIMENSIONS

Model CT36E

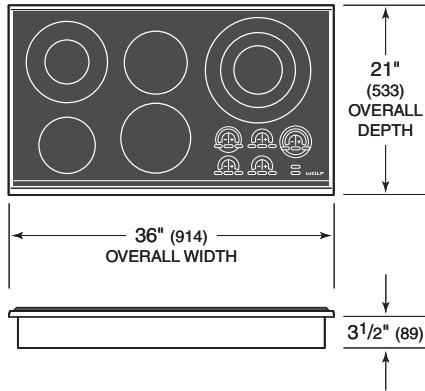

Unit dimensions may vary to ±1/8" (3).

INSTALLATION SPECIFICATIONS

36" (914) Framed Electric Cooktop

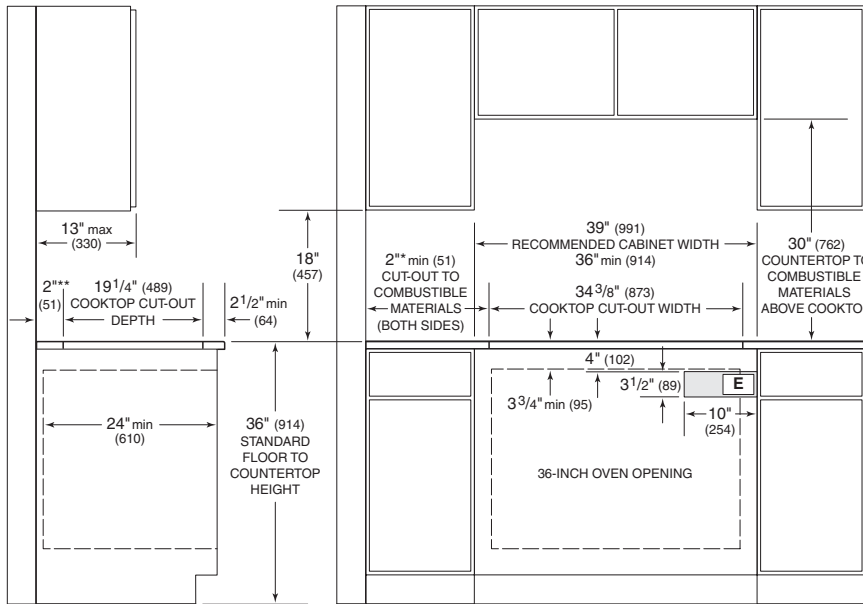

*Minimum clearance from both side edges of cooktop cut-out to combustibles up to 18" (457) above countertop. **Minimum clearance from rear edge of cooktop cut-out to combustibles up to 18" (457) above countertop.

Countertop Cut-Out Dimensions

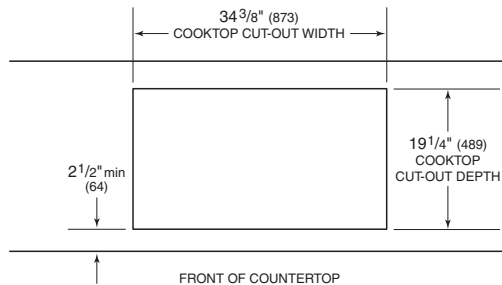

Refer to installation instructions shipped with each Wolf product for detailed specifications.

Discontinued November 2007

MODEL OPTIONS

36" (914) Framed Electric Cooktop

- Classic Trim Finish CT36E/S
- Platinum Trim Finish CT36E/P
- Carbon Trim Finish CT36E/B

SPECIFICATIONS

Model CT36E

- Overall Width 36" (914)
- Overall Height 3 1/2" (89)
- Overall Depth 21" (533)
- Heating Elements Five
- Temperature Zones Eight
- Max Element Power (triple) 1050 W / 2200 W / 2700 W
- Max Element Power (dual) 750 W / 2200 W
- Max Element Power (three single) 1200 W, 1500 W and 1800 W
- Cabinet Width 39" (991) rec, 36" (914) min
- Cabinet Depth 22 3/4" (578) min
- Height Clearance 4" (102) min
- Cut-Out Width* 34 3/8" (873)
- Cut-Out Depth 19 1/4" (489)
- Electrical Supply 240 V AC / 60 Hz / 50 amp, 208 V AC / 60 Hz / 40 amp
- Conduit 4' (1.2 m) flexible 3-wire
- Electrical Rating 9.4 kW at 240 V, 7.1 kW at 208 V
- Shipping Weight 60 lbs (27 kg)

*If the 36" (914) cooktop is to be used with any combination of additional cooktop units or modules with a filler strip, the cut-out width increases to 35" (889).

The outer diameter of the heating elements are 1 7/8" (302), 9 1/8" (232), 7 7/8" (200), 7 1/8" (181) and 6 1/2" (165).

INSTALLATION OPTIONS

A Wolf 36" (914) L Series single oven may be installed below the 36" (914) framed electric cooktop. For this installation, unless you are using cabinets deeper than 24" (610), it is recommended that the electrical supply be placed in the base cabinet to the right of the oven. A 30" (762) L Series or E Series single oven may also be installed below the 36" (914) framed electric cooktop. Refer to the built-in ovens section for additional specifications.

When a 36" (914) L Series oven is installed below a cooktop, it is recommended that the rough opening for the oven be 7 3/4" (197) from the floor to ease use of the oven door.



WOLF UNFRAMED ELECTRIC COOKTOPS

New unframed electric cooktop models will be available in November 2007. These new models will replace the existing cooktop models. New model specifications are found on pages 46-47.

There's no stainless steel trim on the Wolf unframed electric cooktops, just the sophisticated black ceramic glass top, with subtly patterned design. The 30" (762) and 36" (914) unframed electric cooktops can be mounted flush with the top of the countertop or as a frameless installation sitting on top of the countertop surface.

All models feature multiple cooking elements with different zones—concentric rings that give you exceptional control of temperature for pots and pans of every size. New models offer a bridge that connects two elements for an 8-inch by 17-inch, 4400 watt heating area.

All of the heating elements offer True Simmer, and with each cooktop there is one element that enables you to set a temperature for melting.

CAUTION

Flush mount installations are intended for granite, solid surface or stone countertop surfaces only. Failure to use high heat resistant surface will result in countertop damage if hot cooking utensils are accidentally moved off the cooking surface.

FEATURES

Can be mounted flush with top of countertop or as a frameless installation sitting on top of the countertop surface

Easy-to-clean black ceramic glass surface is resistant to scratching, staining, impact and heat—translucent surface allows you to see the glow of hot elements

High-frequency pulsation elements improve cooking performance and control

Bridge-zone element connects two elements to provide a larger cooking area—new models only

Temperature limiter to ensure that safe operating temperature of ceramic glass is never exceeded

Illuminated touch controls with graduated control lighting

True Simmer setting on all elements

Melt setting on one element

Hot-surface indicator light in control panel

Lock mode—cooktop can be locked so that no elements can be turned on

Universal OFF turns all elements off

Countdown timer with 1 to 99 minute range and adjustable sound frequency and volume (new models only)

CSA certified for US and Canada

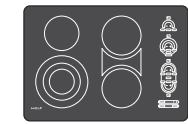

New Model CT30EU 30" (762) Unframed Electric Cooktop



New Model CT36EU 36" (914) Unframed Electric Cooktop

WOLF WARRANTY

Wolf products are covered by a two and five year residential warranty (exclusions apply). See warranty details at the end of this guide.

Dimensions in parentheses are in millimeters unless otherwise specified.

UNFRAMED ELECTRIC COOKTOP FEATURES

New Model CT36EU shown (features vary with existing models)

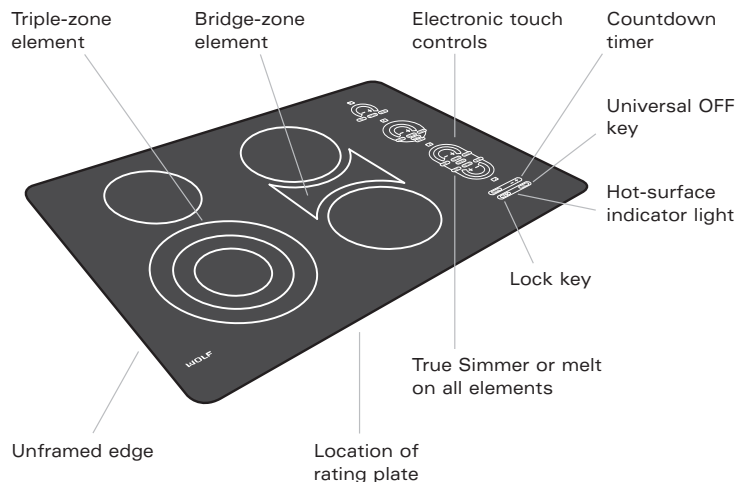

MODEL OPTIONS

Unframed Electric Cooktops

30" (762) Width	CT30EU
36" (914) Width	CT36EU



This appliance is certified by Star-K to meet strict religious regulations in conjunction with specific instructions found on www.star-k.org.



PLANNING INFORMATION

Wolf recommends using 33" (838) cabinets with the 30" (762) cooktop and 39" (991) cabinets with the 36" (914) cooktop.

The Wolf 30" (762) and 36" (914) unframed electric cooktops can be mounted flush with the top of the countertop or as a frameless installation sitting on top of the countertop surface. There's no stainless steel trim, just the black ceramic glass surface. In either installation the cooktop cut-out dimensions are the same. If the cooktop is to be mounted flush with the countertop, you will need to provide a recessed area surrounding the cooktop cut-out.

IMPORTANT NOTE: If the cooktop is to be mounted flush with the countertop, fabrication of the recessed area must take place before the final countertop installation. A template of the countertop cut-out will be provided with the cooktop for fabrication purposes.

Specifications on the following pages provide overall dimensions, countertop cut-out dimensions and installation specifics for the two different-sized cooktops. We have minimized the information contained in the illustrations, concentrating on the critical information you need to plan your installation.

A Wolf L Series or E Series built-in single oven may be installed below these cooktops. Wolf unframed electric cooktops are designed and agency approved for installation with Wolf built-in ovens only. Also, be aware of the depth of the cooktop when planning for this installation.

A Wolf cooktop or Pro ventilation hood is recommended with these cooktops. When installing a ventilation hood, refer to the specific requirements of the hood for the minimum dimension to the countertop. Refer to pages 92-114 for ventilation specifications.

IMPORTANT NOTE: A Wolf downdraft ventilation system cannot be used with the unframed electric cooktops.

IMPORTANT NOTE: Unframed electric cooktops are not designed to be installed in combination with other cooktops or modules.

ELECTRICAL REQUIREMENTS

The electrical requirements vary with the size of the unframed electric cooktop. Refer to the specifications on the following pages for the two different cooktop sizes. Locate electrical supply within the shaded area shown in the Installation Specifications illustration for your model.

IMPORTANT NOTE: When an oven is installed below the cooktop, it is recommended that the electrical supply be placed in the base cabinet to the right of the oven, unless you are using cabinets deeper than 24" (610). Refer to pages 4-14 for additional specifications for built-in ovens.

You must follow all National Electrical Code regulations. In addition, be aware of local codes and ordinances when installing your service.

⚠ WARNING

These cooktops are intended for indoor use.

ACCESSORIES

Optional accessories are available through your Wolf dealer. To obtain local dealer information, visit the Showroom Locator section of our website, wolfappliance.com.

This appliance must be installed in accordance with National Electrical Code regulations as well as all state, municipal and local codes. The correct voltage, frequency and amperage must be supplied to the appliance from a dedicated, grounded circuit that is protected by a properly sized circuit breaker or time delay fuse. The proper voltage, frequency and amperage ratings are listed on the product rating plate.



NEW Available November 2007

SPECIFICATIONS

New Model CT30EU

Overall Width	30" (762)
Overall Height	4 1/4" (108)
Overall Depth	21" (533)
Heating Elements	Three
Temperature Zones	Four
Max Element Power	
Triple	900 / 1800 / 2500 W
Singles	1200 W and (2) 1800 W
Singles with Bridge	4400 W
Cabinet Width	33" (383) rec
	30" (762) min
Cabinet Depth	22 3/4" (578) min
Height Clearance	4 1/2" (114) min
Cut-Out Width	28 3/8" (721)
Cut-Out Depth	19 1/4" (489)
Electrical Supply	240 V AC / 60 Hz / 40 amp
	208 V AC / 60 Hz / 30 amp
Conduit	4' (1.2 m) flexible 3-wire
Electrical Rating	8.1 kW at 240 V
	6.1 kW at 208 V
Shipping Weight	45 lbs (20 kg)

The outer diameter of the heating elements are 10" (254), two 8" (203) and 6 1/2" (165). The bridge with elements is 8" (203) x 17" (432).

IMPORTANT NOTE: A minimum height clearance of 6 1/4" (159) is required between countertop and any combustible surface directly below cooktop.

INSTALLATION OPTIONS

The Model CT30EU unframed electric cooktop can be mounted flush with the top of the countertop or as a frameless installation sitting on top of the countertop surface. In either installation the cooktop cut-out dimensions are the same. If mounted flush with the countertop, a recessed area surrounding the cooktop cut-out is required.

IMPORTANT NOTE: Flush mount installations are intended for granite, solid surface or stone countertop surfaces only. If the cooktop is to be mounted flush with the countertop, fabrication of the recessed area must take place before the countertop installation. A template of the countertop cut-out will be provided with the cooktop for fabrication purposes.

A Wolf 30" (762) L Series or E Series single oven may be installed below the Model CT30EU. For this installation, unless you are using cabinets deeper than 24" (610), it is recommended that the electrical supply be placed in the base cabinet to the right of the oven. Refer to the built-in ovens section for additional specifications.

OVERALL DIMENSIONS

New Model CT30EU

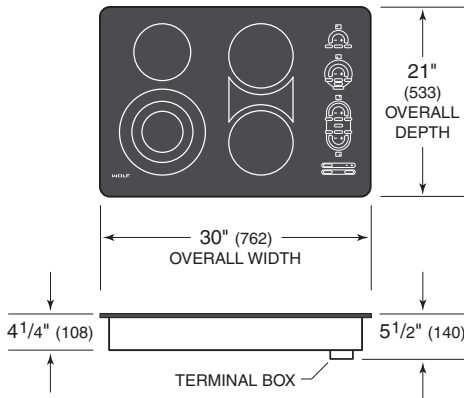

Unit dimensions may vary to ±1/8" (3).

INSTALLATION SPECIFICATIONS

New Model CT30EU

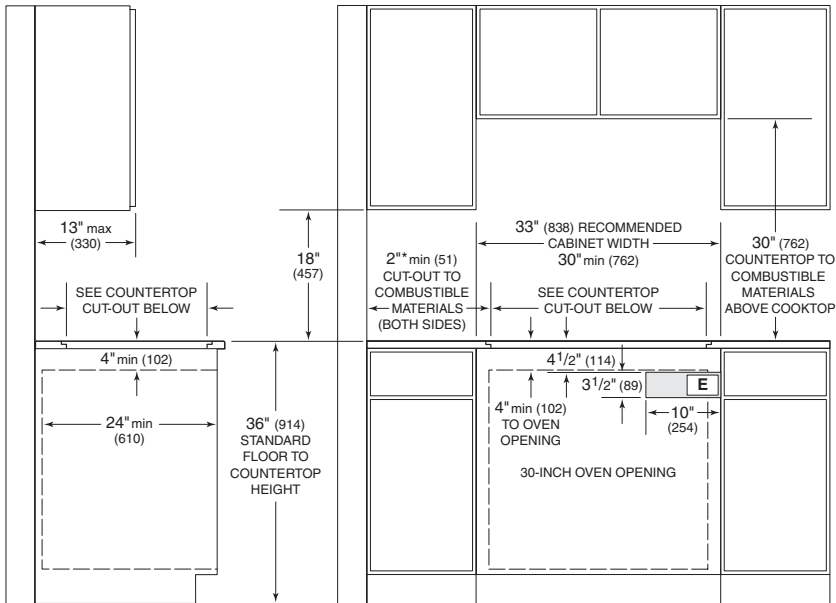

*Minimum clearance from both side edges and back edge of cooktop cut-out to combustible materials up to 18" (457) above countertop.

Countertop Cut-Out Dimensions

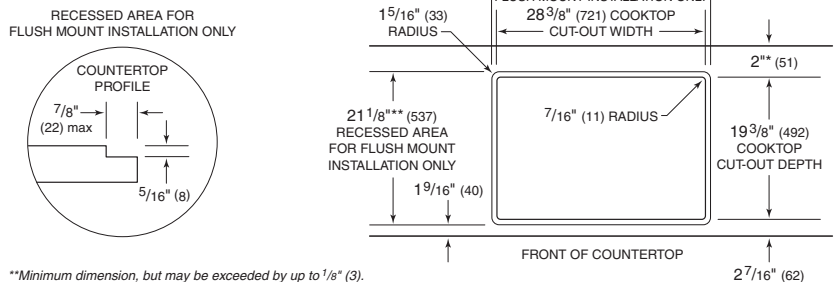

**Minimum dimension, but may be exceeded by up to 1/8" (3).

IMPORTANT NOTE: For flush mount applications, it is recommended that you measure the cooktop glass before cutting the countertop to ensure a proper fit. Small variances may exist between the template and the cooktop.



OVERALL DIMENSIONS

New Model CT36EU

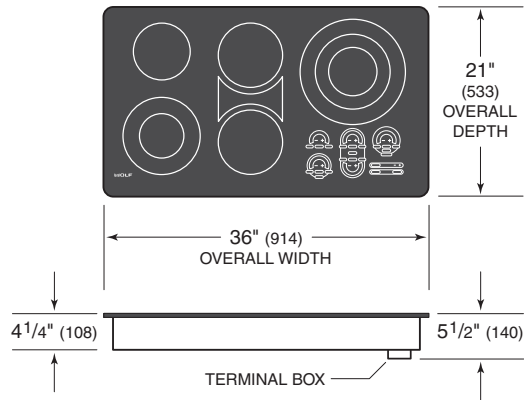

Unit dimensions may vary to ±1/8" (3).

INSTALLATION SPECIFICATIONS

New Model CT36EU

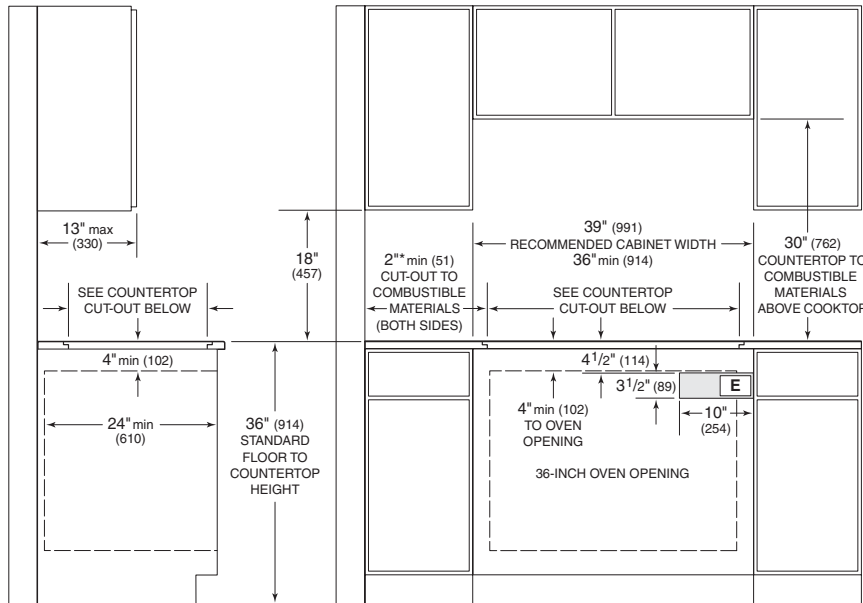

*Minimum clearance from both side edges and back edge of cooktop cut-out to combustible materials up to 18" (457) above countertop.

Countertop Cut-Out Dimensions

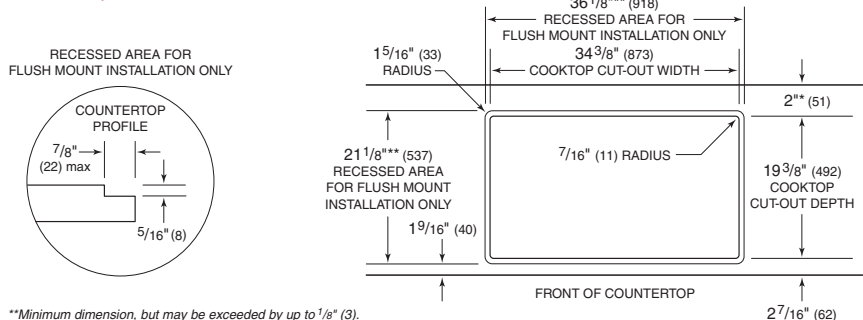

**Minimum dimension, but may be exceeded by up to 1/8" (3).

IMPORTANT NOTE: For flush mount applications, it is recommended that you measure the cooktop glass before cutting the countertop to ensure a proper fit. Small variances may exist between the template and the cooktop.

NEW Available November 2007

SPECIFICATIONS

New Model CT36EU

Overall Width	36" (914)
Overall Height	4 1/4" (108)
Overall Depth	21" (533)
Heating Elements	Four
Temperature Zones	Five
Max Element Power	
Triple	1050 / 2200 / 2700 W
Dual	700 / 2200 W
Singles	1200 W and (2) 1800 W
Singles with Bridge	4400 W
Cabinet Width	39" (991) rec 36" (914) min
Cabinet Depth	22 3/4" (578) min
Height Clearance	4 1/2" (114) min
Cut-Out Width	34 3/8" (873)
Cut-Out Depth	19 1/4" (489)
Electrical Supply	240 V AC / 60 Hz / 50 amp 208 V AC / 60 Hz / 40 amp
Conduit	4' (1.2 m) flexible 3-wire
Electrical Rating	10.5 kW at 240 V 7.9 kW at 208 V
Shipping Weight	60 lbs (27 kg)

The outer diameter of the heating elements are 12" (305), 9" (229), two 8" (203) and 6 1/2" (165). The bridge with elements is 8" (203) x 17" (432).

IMPORTANT NOTE: A minimum height clearance of 6 1/4" (159) is required between countertop and any combustible surface directly below cooktop.

INSTALLATION OPTIONS

The Model CT36EU unframed electric cooktop can be mounted flush with the top of the countertop or as a frameless installation sitting on top of the countertop surface. In either installation the cooktop cut-out dimensions are the same. If mounted flush with the countertop, a recessed area surrounding the cooktop cut-out is required.

IMPORTANT NOTE: Flush mount installations are intended for granite, solid surface or stone countertop surfaces only. If the cooktop is to be mounted flush with the countertop, fabrication of the recessed area must take place before the countertop installation. A template of the countertop cut-out will be provided with the cooktop for fabrication purposes.

A Wolf 36" (914) L Series single oven may be installed below the Model CT36EU. For this installation, unless you are using cabinets deeper than 24" (610), it is recommended that the electrical supply be placed in the base cabinet to the right of the oven. A 30" (762) L Series or E Series single oven may also be installed below the Model CT36EU.

When a 36" (914) L Series oven is installed below a cooktop, it is recommended that the rough opening for the oven be 7 3/4" (197) from the floor to ease use of the oven door. 47



Discontinued November 2007

SPECIFICATIONS

Model CT30EU

Overall Width	30" (762)
Overall Height	4" (102)
Overall Depth	21" (533)
Heating Elements	Four
Temperature Zones	Six
Max Element Power (two dual)	750 W / 2200 W and 950 W / 1900 W
Max Element Power (two single)	1200 W and 1500 W
Cabinet Width	33" (383) rec 30" (762) min
Cabinet Depth	22 ³ / ₄ " (578) min
Height Clearance	4" (102) min
Cut-Out Width	28 ³ / ₈ " (721)
Cut-Out Depth	19 ³ / ₈ " (492)
Electrical Supply	240 V AC / 60 Hz / 40 amp 208 V AC / 60 Hz / 30 amp
Conduit	4' (1.2 m) flexible 3-wire
Electrical Rating	6.8 kW at 240 V 5.2 kW at 208 V
Shipping Weight	45 lbs (20 kg)

The outer diameter of the heating elements are 9" (229), 8¹/₂" (216), 7" (179) and 6¹/₂" (165).

INSTALLATION OPTIONS

The Model CT30EU unframed electric cooktop can be mounted flush with the top of the countertop or as a frameless installation sitting on top of the countertop surface. In either installation the cooktop cut-out dimensions are the same. If mounted flush with the countertop, a recessed area surrounding the cooktop cut-out is required.

IMPORTANT NOTE: Flush mount installations are intended for granite, solid surface or stone countertop surfaces only. If the cooktop is to be mounted flush with the countertop, fabrication of the recessed area must take place before the countertop installation. A template of the countertop cut-out will be provided with the cooktop for fabrication purposes.

A Wolf 30" (762) L Series or E Series single oven may be installed below the Model CT30EU. For this installation, unless you are using cabinets deeper than 24" (610), it is recommended that the electrical supply be placed in the base cabinet to the right of the oven. Refer to the built-in ovens section for additional specifications.

Dimensions in parentheses are in millimeters unless otherwise specified.

OVERALL DIMENSIONS

Model CT30EU

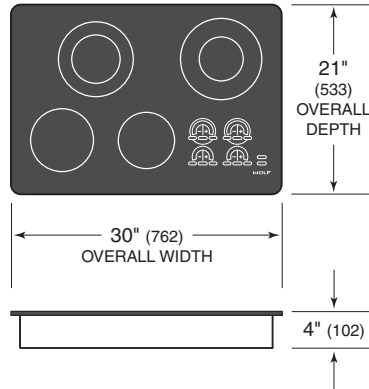

Unit dimensions may vary to ±1/8" (3).

INSTALLATION SPECIFICATIONS

Model CT30EU

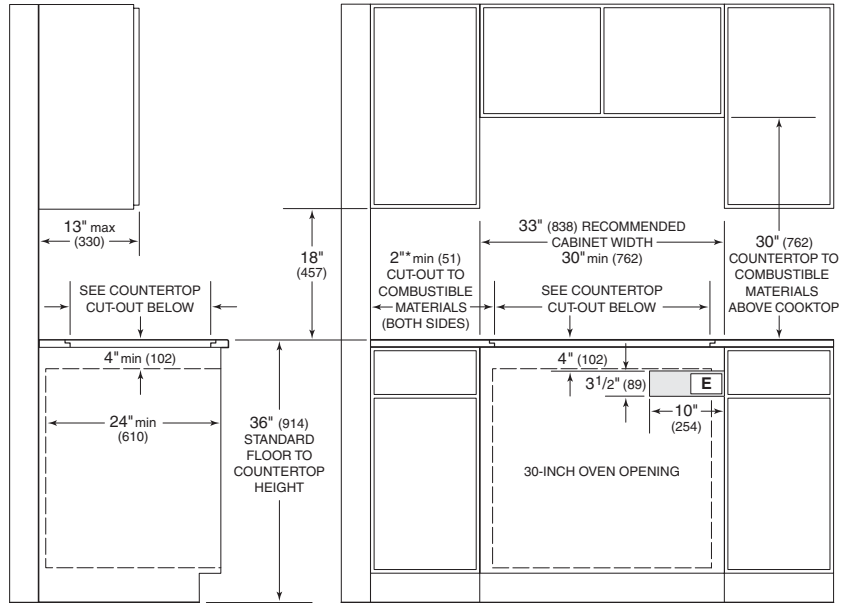

*Minimum clearance from both side edges and back edge of cooktop cut-out to combustible materials up to 18" (457) above countertop.

Countertop Cut-Out Dimensions

RECESSED AREA FOR FLUSH MOUNT INSTALLATION ONLY

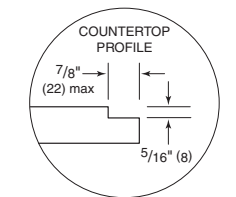

**Minimum dimension, but may be exceeded by up to 1/8" (3).

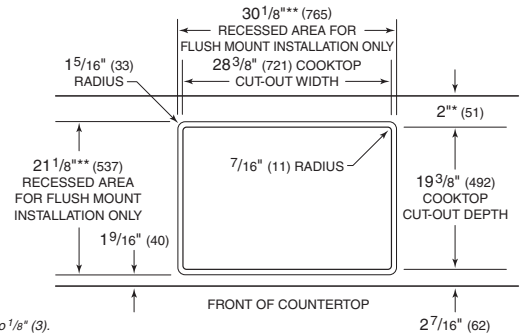

IMPORTANT NOTE: For flush mount applications, it is recommended that you measure the cooktop glass before cutting the countertop to ensure a proper fit. Small variances may exist between the template and the cooktop.



OVERALL DIMENSIONS

Model CT36EU

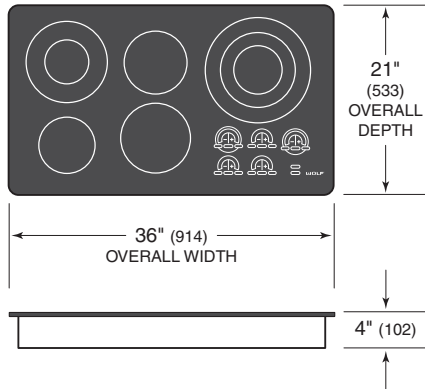

Unit dimensions may vary to ±1/8" (3).

INSTALLATION SPECIFICATIONS

Model CT36EU

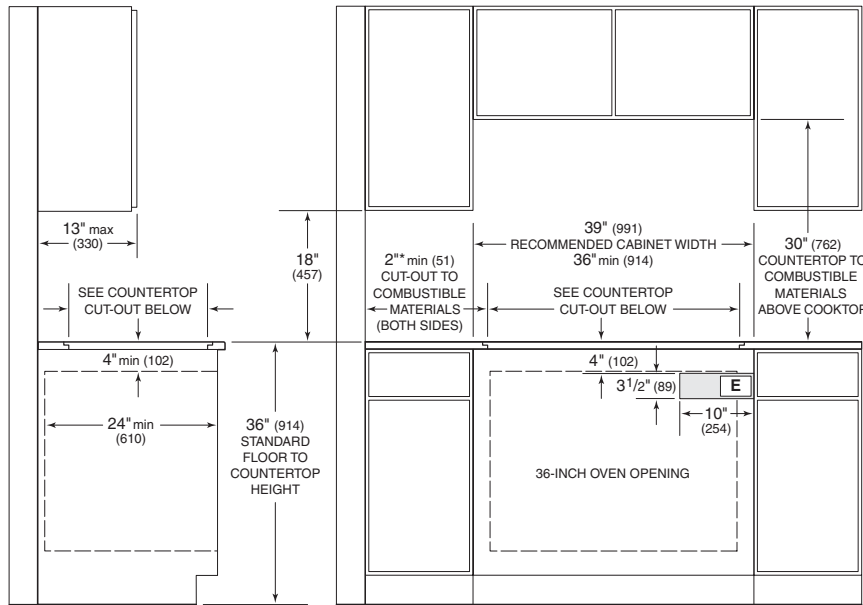

*Minimum clearance from both side edges and back edge of cooktop cut-out to combustible materials up to 18" (457) above countertop.

Countertop Cut-Out Dimensions

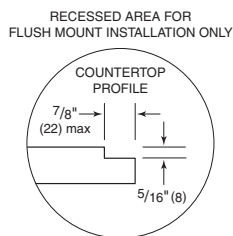

**Minimum dimension, but may be exceeded by up to 1/8" (3).

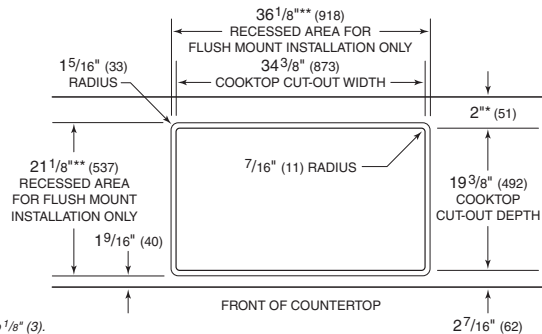

IMPORTANT NOTE: For flush mount applications, it is recommended that you measure the cooktop glass before cutting the countertop to ensure a proper fit. Small variances may exist between the template and the cooktop.

Discontinued November 2007

SPECIFICATIONS

Model CT36EU

Overall Width	36" (914)
Overall Height	4" (102)
Overall Depth	21" (533)
Heating Elements	Five
Temperature Zones	Eight
Max Element Power (triple)	1050 W / 2200 W / 2700 W
Max Element Power (dual)	750 W / 2200 W
Max Element Power (three single)	1200 W, 1500 W and 1800 W
Cabinet Width	39" (991) rec 36" (914) min
Cabinet Depth	22 3/4" (578) min
Height Clearance	4" (102) min
Cut-Out Width	34 3/8" (873)
Cut-Out Depth	19 3/8" (492)
Electrical Supply	240 V AC / 60 Hz / 50 amp 208 V AC / 60 Hz / 40 amp
Conduit	4' (1.2 m) flexible 3-wire
Electrical Rating	9.4 kW at 240 V 7.1 kW at 208 V
Shipping Weight	60 lbs (27 kg)

The outer diameter of the heating elements are 1 1/8" (302), 9/8" (232), 7 7/8" (200), 7 1/8" (181) and 6 1/2" (165).

INSTALLATION OPTIONS

The Model CT36EU unframed electric cooktop can be mounted flush with the top of the countertop or as a frameless installation sitting on top of the countertop surface. In either installation the cooktop cut-out dimensions are the same. If mounted flush with the countertop, a recessed area surrounding the cooktop cut-out is required.

IMPORTANT NOTE: Flush mount installations are intended for granite, solid surface or stone countertop surfaces only. If the cooktop is to be mounted flush with the countertop, fabrication of the recessed area must take place before the countertop installation. A template of the countertop cut-out will be provided with the cooktop for fabrication purposes.

A Wolf 36" (914) L Series single oven may be installed below the Model CT36EU. For this installation, unless you are using cabinets deeper than 24" (610), it is recommended that the electrical supply be placed in the base cabinet to the right of the oven. A 30" (762) L Series or E Series single oven may also be installed below the Model CT36EU.

When a 36" (914) L Series oven is installed below a cooktop, it is recommended that the rough opening for the oven be 7 3/4" (197) from the floor to ease use of the oven door.



WOLF GAS COOKTOPS

WOLF GAS COOKTOPS

New features make cooking a greater pleasure than ever. For instance, at higher settings the dual-stacked burner design uses its upper-level burner for maximum heat transfer. Merely turn down the illuminated knob and the lower-tier burners deliver fine-tuning control and True Simmer. You'll see why we patented this concept when you can have the slightest of flame and enjoy a simmer with no boiling or scorching. This is heat tailored for every cooking vessel you're using—from the largest stockpot to the smallest melting pan.

All gas cooktops are available in the classic stainless steel finish, and for the 30" (762) and 36" (914) cooktops you can choose the premium platinum stainless steel finish. The 15" (381) gas cooktop is available only in the classic stainless steel finish.

A more powerful 15,000 Btu/hr (4.4 kW) burner is standard on the 30" (762) and 36" (914) gas cooktops.

The dual-stacked sealed burners and deep recess of the seamless drawn pan area make cleanup of any of those previously unsightly spills a snap.

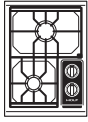

Model CT15G
15" (381)
Gas Cooktop

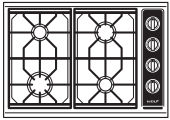

Model CT30G
30" (762)
Gas Cooktop

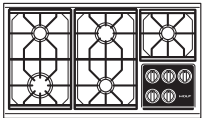

Model CT36G
36" (914)
Gas Cooktop

FEATURES

Available in natural and LP gas

Stainless steel top construction, available in classic and platinum stainless steel finishes—Model CT15G available in classic finish only

Dual-stacked, sealed burners with automatic re-ignition on all settings

Large 15,000 Btu/hr (4.4 kW) burner with 800 Btu/hr (.2 kW) delivered at simmer—Models CT30G and CT36G only

Medium 12,000 Btu/hr (3.5 kW) burner with 800 Btu/hr (.2 kW) delivered at simmer

Small 9,200 Btu/hr (2.7 kW) burners with 300 Btu/hr (.1 kW) delivered at simmer

Individual spark ignition system

True Simmer setting on all burners

Illuminated control panel with two-tiered control knobs

Low-profile, cast iron continuous burner grates with matte porcelain finish

Seamless drawn burner pan

CSA certified for US and Canada



This appliance is certified by Star-K to meet strict religious regulations in conjunction with specific instructions found on www.star-k.org.

WOLF WARRANTY

Wolf products are covered by a two and five year residential warranty (exclusions apply). See warranty details at the end of this guide.

Dimensions in parentheses are in millimeters unless otherwise specified.

GAS COOKTOP FEATURES

Model CT36G shown

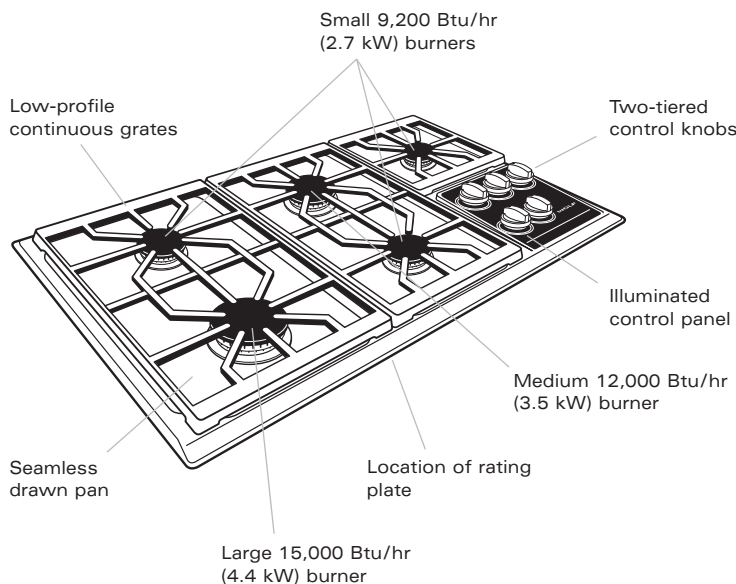

MODEL OPTIONS

Gas Cooktops

15" (381) Gas Cooktop

Classic Stainless **CT15G/S**

30" (762) Gas Cooktop

Classic Stainless **CT30G/S**

Platinum Stainless **CT30G/P**

36" (914) Gas Cooktop

Classic Stainless **CT36G/S**

Platinum Stainless **CT36G/P**

Natural gas models listed; for LP gas add (-LP) to the model number.



PLANNING INFORMATION

Wolf offers three sizes of gas cooktops to choose from to address your clients' needs. The 30" (762) and 36" (914) cooktops are available in classic and platinum stainless steel finish. The 15" (381) cooktop module comes in classic stainless steel only.

Wolf recommends using 33" (838) cabinets with the 30" (762) cooktop and 39" (991) cabinets with the 36" (914) cooktop.

Specifications on the following pages provide overall dimensions, countertop cut-out dimensions and installation specifics for the three different-sized cooktops. We have minimized the information contained in the illustrations, concentrating on the critical information you need to plan your installation.

A Wolf L Series or E Series built-in single oven may be installed below these cooktops. Wolf gas cooktops are designed and agency approved for installation with Wolf built-in ovens only. Also, be aware of the depth of the cooktop when planning for this installation.

Multiple cooktops and/or integrated modules can be installed side by side. Refer to the countertop cut-out dimensions on page 55 when planning for this installation.

These cooktops can accommodate a Wolf cooktop hood, downdraft system or Pro ventilation hood or hood liner. When installing a ventilation hood, refer to the specific requirements of the hood for the minimum dimension to the countertop. Refer to pages 92-114 for ventilation specifications.

ACCESSORIES

Gas Cooktops

One-piece wok and single burner grate (Models CT30G and CT36G)

Filler strip

Bracket supports for installation of two integrated modules with downdraft (Model DD30 only)

High altitude conversion kit

Accessories are available through your Wolf dealer. To obtain local dealer information, visit the Showroom Locator section of our website, wolfappliance.com.

ELECTRICAL | GAS REQUIREMENTS

The electric ignition system is a safe, convenient and reliable way to provide ignition for the burners. However, you need to make provisions for a separate 120 V AC, 60 Hz power supply. The service should have its own 15 amp circuit breaker, and a grounded 3-prong receptacle should be located within reach of the 6' (1.8 m) power cord.

IMPORTANT NOTE: A ground fault circuit interrupter (GFCI) is not recommended and may cause interruption of operation.

Wolf gas cooktops are designed to operate on natural gas at 5" (12.5 mb) WC (water column) pressure or LP (propane) gas at 10" (25 mb) WC pressure. The minimum line pressure for natural gas is 7" (17.5 mb) WC and 11" (27.4 mb) WC for LP gas. The maximum gas supply pressure to the regulator should never exceed 14" (34.9 mb) WC, .5 psi (3.5 kPa). They are supplied with a 1/2" NPT male gas connection at the right rear corner on the bottom of the cooktop. The male connector exits the unit straight down, and you are supplied with a regulator with two female connectors.

Locate electrical and gas supply within the shaded area shown in the Installation Specifications illustration for your model.

IMPORTANT NOTE: When an oven is installed below the cooktop, it is recommended that the electrical supply be placed in the base cabinet to the right of the oven, unless you are using cabinets deeper than 24" (610). Refer to pages 4-14 for additional specifications for built-in ovens.

When a gas cooktop is installed above cabinets, the gas and electrical placement is not critical. A grounded outlet needs to be placed within 4' (1.2 m) of the right rear of the cooktop.

You must follow all National Electrical Code and gas regulations. In addition, be aware of local codes and ordinances when installing your services.

⚠ WARNING

These cooktops are intended for indoor use.

HIGH ALTITUDE

Wolf gas cooktops using natural gas function up to an altitude of 8,000' (2438 m) without any adjustment. Natural gas installations from 8,000' (2438 m) to 10,000' (3048 m) need the high altitude conversion kit. LP gas installations will operate up to 10,000' (3048 m) without adjustment.



WOLF GAS COOKTOPS

OVERALL DIMENSIONS 15" (381) Gas Cooktop

MODEL OPTIONS 15" (381) Gas Cooktop

- Classic / Natural Gas **CT15G/S**
- Classic / LP Gas **CT15G/S-LP**

SPECIFICATIONS 15" (381) Gas Cooktop

- Overall Width **15" (381)**
- Overall Height **4" (102)**
- Overall Depth **21" (533)**
- Burner Rating **(1) 12,000 Btu/hr (3.5 kW) with 800 Btu/hr (.2 kW) delivered at simmer**
(1) 9,200 Btu/hr (2.7 kW) with 300 Btu/hr (.1 kW) delivered at simmer
- Cabinet Depth **22³/₄" (578) min**
- Height Clearance **4" (102) min**
- Cut-Out Width **14" (356)**
- Cut-Out Depth **19¹/₄" (489)**
- Electrical Supply **120 V AC, 60 Hz**
15 amp circuit
- Power Cord **6' (1.8 m) 3-prong**
- Gas Rating **21,200 Btu/hr (6.2 kW)**
- Shipping Weight **30 lbs (14 kg)**

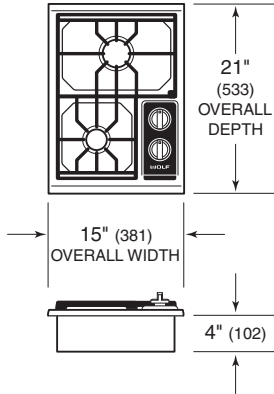

Unit dimensions may vary to ±1/8" (3).

INSTALLATION SPECIFICATIONS 15" (381) Gas Cooktop

Unit dimensions may vary to ±1/8" (3).

INSTALLATION OPTIONS

For the 15" (381) gas cooktop, the gas service may be supplied through the floor if the cooktop is not installed above an oven. Refer to the illustration for specifics on placement of gas and electrical.

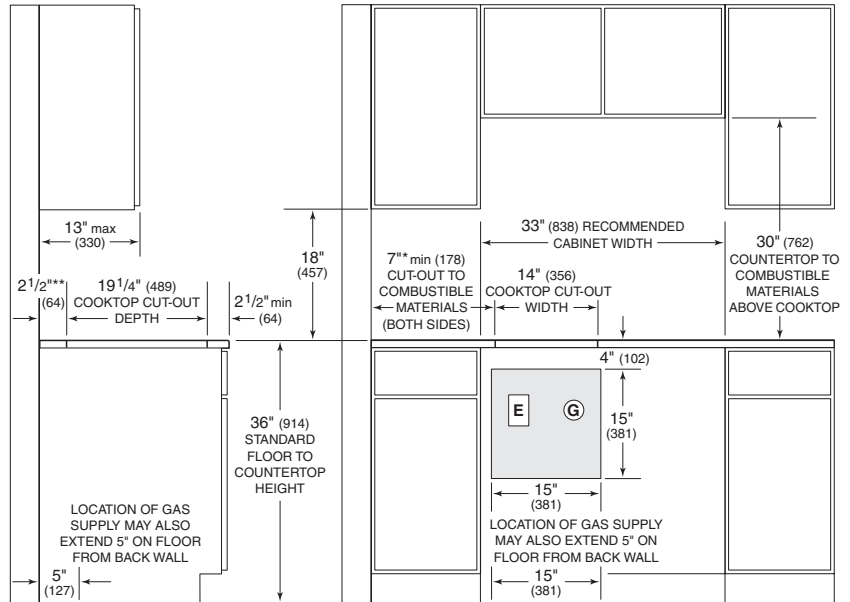

NOTE: Application shown allows for installation of two 15" (381) modules side-by-side with 33" (838) recommended cabinet width. 18" (457) recommended cabinet width for installation of single 15" (381) cooktop or module. *Minimum clearance from both side edges of cooktop cut-out to combustibles up to 18" (457) above countertop. **Minimum clearance from rear edge of cooktop cut-out to combustibles up to 18" (457) above countertop.

Countertop Cut-Out Dimensions

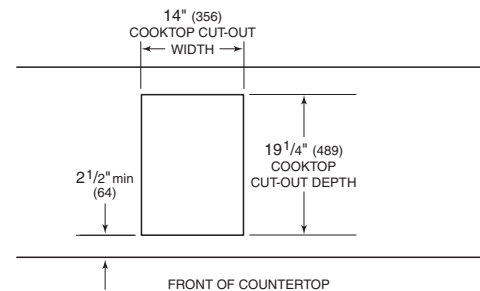

Dimensions in parentheses are in millimeters unless otherwise specified.



OVERALL DIMENSIONS

30" (762) Gas Cooktop

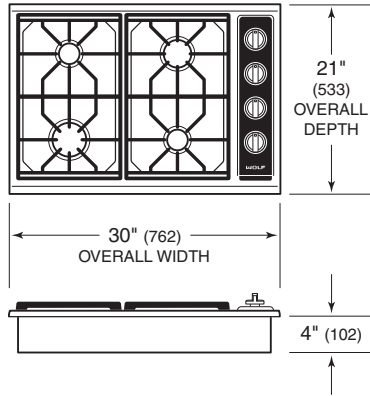

Unit dimensions may vary to ±1/8" (3).

INSTALLATION SPECIFICATIONS

30" (762) Gas Cooktop

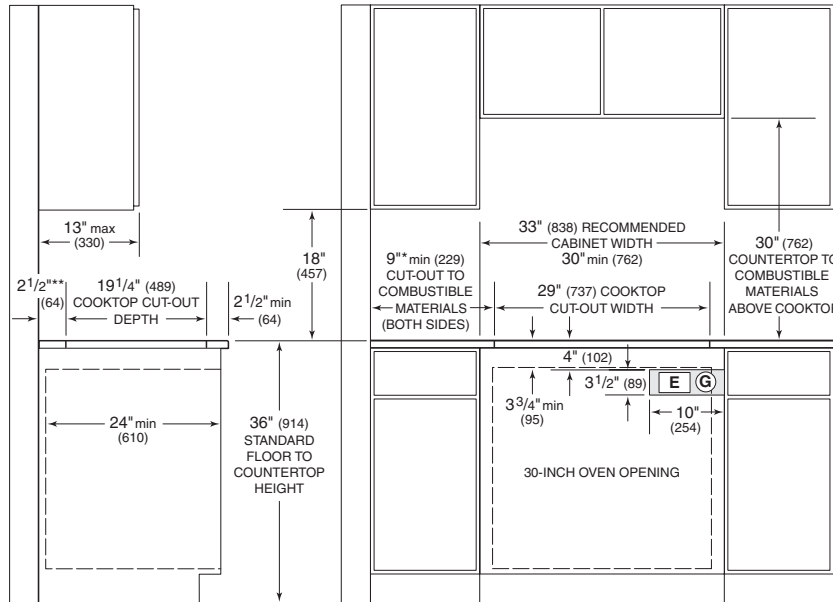

*Minimum clearance from both side edges of cooktop cut-out to combustible materials up to 18" (457) above countertop.
 **Minimum clearance from rear edge of cooktop cut-out to combustible materials up to 18" (457) above countertop.

Countertop Cut-Out Dimensions

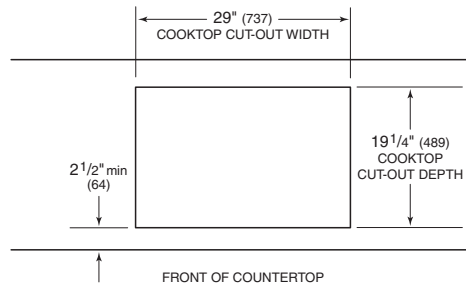

MODEL OPTIONS

30" (762) Gas Cooktop

- Classic / Natural Gas CT30G/S
- Platinum / Natural Gas CT30G/P
- Classic / LP Gas CT30G/S-LP
- Platinum / LP Gas CT30G/P-LP

SPECIFICATIONS

30" (762) Gas Cooktop

- Overall Width 30" (762)
- Overall Height 4" (102)
- Overall Depth 21" (533)
- Burner Rating (1) 15,000 Btu/hr (4.4 kW) with 800 Btu/hr (.2 kW) delivered at simmer
 (1) 12,000 Btu/hr (3.5 kW) with 800 Btu/hr (.2 kW) delivered at simmer
 (2) 9,200 Btu/hr (2.7 kW) with 300 Btu/hr (.1 kW) delivered at simmer
- Cabinet Width 33" (383) rec
 30" (762) min
- Cabinet Depth 22 3/4" (578) min
- Height Clearance 4" (102) min
- Cut-Out Width 29" (737)
- Cut-Out Depth 19 1/4" (489)
- Electrical Supply 120 V AC, 60 Hz
 15 amp circuit
- Power Cord 6' (1.8 m) 3-prong
- Gas Rating 45,400 Btu/hr (13.3 kW)
- Shipping Weight 50 lbs (23 kg)

Unit dimensions may vary to ±1/8" (3).

INSTALLATION OPTIONS

A Wolf 30" (762) L Series or E Series single oven may be installed below the 30" (762) gas cooktop. For this installation, unless you are using cabinets deeper than 24" (610), it is recommended that the electrical and gas supply be placed in the base cabinet to the right of the oven. Refer to the built-in ovens section for additional specifications.

Refer to installation instructions shipped with each Wolf product for detailed specifications.



WOLF GAS COOKTOPS

OVERALL DIMENSIONS

36" (914) Gas Cooktop

MODEL OPTIONS

36" (914) Gas Cooktop

Classic / Natural Gas	CT36G/S
Platinum / Natural Gas	CT36G/P
Classic / LP Gas	CT36G/S-LP
Platinum / LP Gas	CT36G/P-LP

SPECIFICATIONS

36" (914) Gas Cooktop

Overall Width	36" (914)
Overall Height	4" (102)
Overall Depth	21" (533)
Burner Rating	(1) 15,000 Btu/hr (4.4 kW) with 800 Btu/hr (.2 kW) delivered at simmer (1) 12,000 Btu/hr (3.5 kW) with 800 Btu/hr (.2 kW) delivered at simmer (3) 9,200 Btu/hr (2.7 kW) with 300 Btu/hr (.1 kW) delivered at simmer
Cabinet Width	39" (991) rec 36" (914) min
Cabinet Depth	22³/₄" (578) min
Height Clearance	4" (102) min
Cut-Out Width	35" (889)
Cut-Out Depth	19¹/₄" (489)
Electrical Supply	120 V AC, 60 Hz 15 amp circuit
Power Cord	6' (1.8 m) 3-prong
Gas Rating	54,600 Btu/hr (16.0 kW)
Shipping Weight	67 lbs (30 kg)

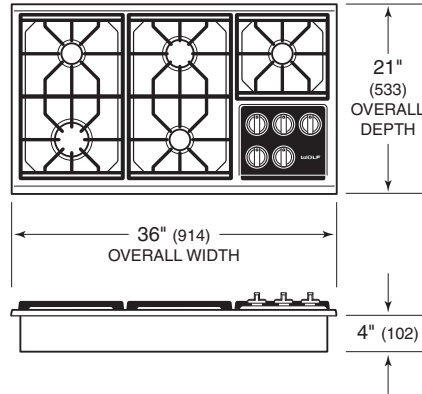

Unit dimensions may vary to ±1/8" (3).

INSTALLATION SPECIFICATIONS

36" (914) Gas Cooktop

INSTALLATION OPTIONS

A Wolf 36" (914) L Series single oven may be installed below the 36" (914) gas cooktop. For this installation, unless you are using cabinets deeper than 24" (610), it is recommended that the electrical and gas supply be placed in the base cabinet to the right of the oven. A Wolf 30" (762) L Series or E Series single oven may also be installed below the 36" (914) gas cooktop. Refer to the built-in ovens section for additional specifications.

When a 36" (914) L Series oven is installed below a cooktop, it is recommended that the rough opening for the oven be 7³/₄" (197) from the floor to ease use of the oven door.

Dimensions in parentheses are in millimeters unless otherwise specified.

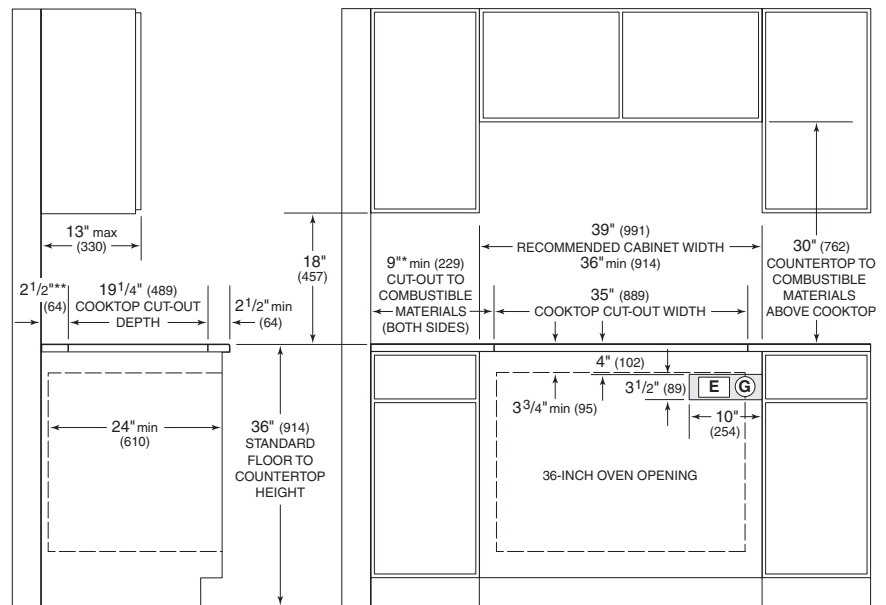

*Minimum clearance from both side edges of cooktop cut-out to combustible materials up to 18" (457) above countertop.
**Minimum clearance from rear edge of cooktop cut-out to combustible materials up to 18" (457) above countertop.

Countertop Cut-Out Dimensions

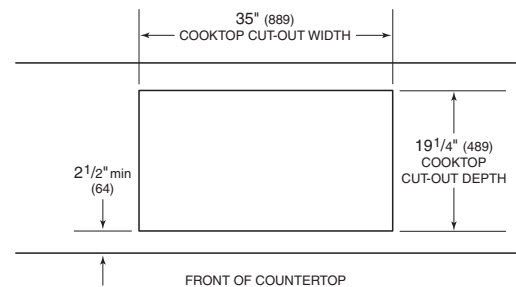

Refer to installation instructions shipped with each Wolf product for detailed specifications.



WOLF INTEGRATED MODULES

With Wolf’s integrated modules, you have the ultimate in customization. You can create your own design by mixing and matching the various components within this system. And when you couple these modules with other cooktops within the Wolf inventory, you and your client will truly understand freedom of choice.

Some modules integrate with their larger counterparts, right down to their low-profile grates, dual-stacked gas burners, deep spill pan and illuminated controls. The two-element electric and dual-stacked sealed burner gas cooktop modules deliver the same performance and appearance as the larger electric and gas cooktops.

Some integrated modules can be installed together or with a 30" (762) or 36" (914) cooktop. When multiple cooktops or modules are installed side by side, the cut-out dimensions shown in the illustration below are derived by adding 1 1/4" (32) additional space for each additional unit, to give you your total cut-out width.

IMPORTANT NOTE: Refer to specifications on the following pages for specific installation requirements and limitations for each integrated module. Review specific installation instructions for product-to-product capabilities. Additional information is provided in the specifications pdf files on our website, wolfappliance.com.

Refer to the following illustration for countertop cut-out dimensions for the installation of multiple cooktops or modules.

IMPORTANT NOTE: When multiple cooktops or modules are installed side by side, each unit must have its own separate recommended electrical circuit. When multiple gas cooktops or modules are installed next to one another, they can receive their gas supply from a common line. However, each unit **must** have its own regulator installed between the mainline and the cooktop or module.

⚠ WARNING
 These integrated modules are intended for indoor use.

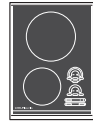

New Model CT15I/S Induction Cooktop



New Model CT15E/S Electric Cooktop



Model IG15/S Electric Grill



Model IS15/S Electric Steamer



Model IF15/S Electric Fryer

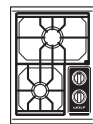

Model CT15G/S Gas Cooktop



Model IM15/S Gas Multi-Function Cooktop

COUNTERTOP CUT-OUT DIMENSIONS

Installation of Multiple Cooktops or Modules

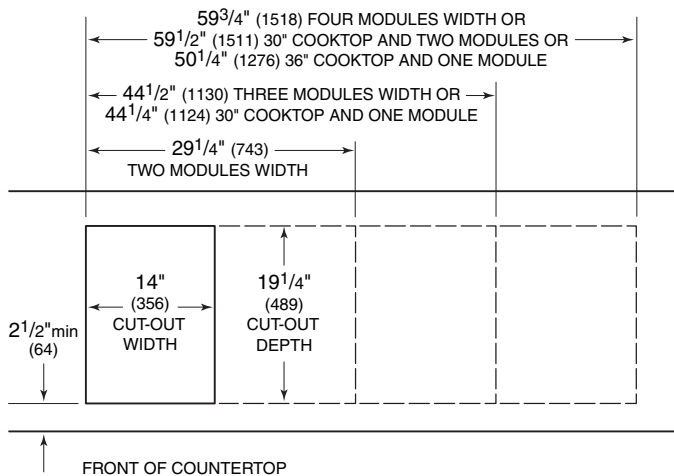

INTEGRATED MODULES
 15" (381) Width

Induction Cooktop	CT15I/S
Electric Cooktop	CT15E/S
Electric Grill	IG15/S
Electric Steamer	IS15/S
Electric Fryer	IF15/S
Gas Cooktop	CT15G/S
Gas Multi-Function Cooktop	IM15/S

All integrated modules are available in the classic stainless steel finish.

IMPORTANT NOTE: When two or more modules are installed together, an integrated module filler strip is recommended. If a Model DD30 downdraft system is also installed, an integrated module support for downdraft ventilation is required. Contact your Wolf dealer for information on these accessory components.

IMPORTANT NOTE: Refer to specifications on the following pages for specific installation requirements and limitations for each integrated module. Specifications for Model CT15E/S are found on page 38 and Model CT15G/S specifications are on page 52.



ELECTRIC GRILL MODULE



Model IG15/S
Electric Grill Module

Who says you have to sacrifice the fun of grilling when the weather changes and you cannot take advantage of the outdoors? With this grill cooktop you can easily handle steaks and all sorts of food without the hassle of lava rocks or briquettes.

There are two individual heating elements—front and back—on this module that enable you to cook on one side while keeping other items at serving temperature.

For ease of cleaning, there are porcelainized plates below two 1400-watt heating elements that accumulate any unwanted grease and drain it away.

The Wolf electric grill module is available in classic stainless steel.

FEATURES

Integrated design allows for installation of multiple cooktops or modules

Stainless steel top construction with classic stainless steel finish

Two 1400-watt, individually controlled heating elements—front and back—for even grilling

Illuminated electronic touch controls with graduated control lighting

Low-profile, one-piece cast iron grilling grate with matte porcelain finish

Black porcelain-coated grease deflection plates

Easy-to-clean, removable porcelain collection pan

Independent digital timer

CSA certified for US and Canada



This appliance is certified by Star-K to meet strict religious regulations in conjunction with specific instructions found on www.star-k.org.

WOLF WARRANTY

Wolf products are covered by a two and five year residential warranty (exclusions apply). See warranty details at the end of this guide.

Dimensions in parentheses are in millimeters unless otherwise specified.

ELECTRIC GRILL FEATURES

Model IG15/S

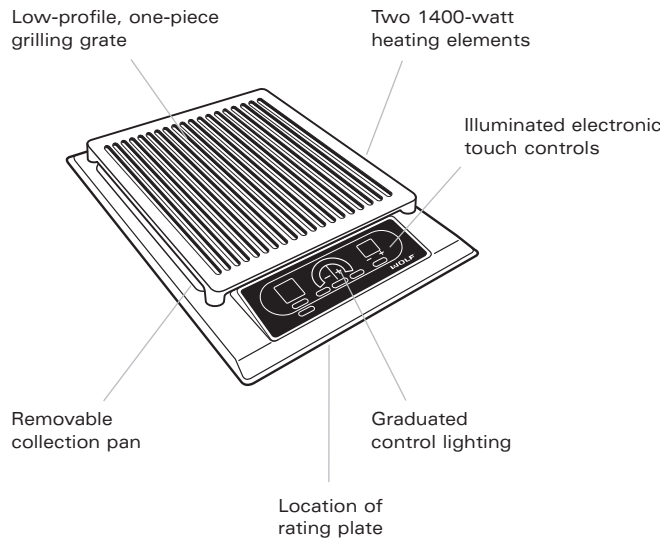

OVERALL DIMENSIONS

Model IG15/S

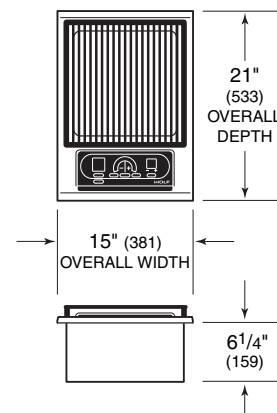

ACCESSORIES

Electric Grill Module

Filler strip

Accessories are available through your Wolf dealer. To obtain local dealer information, visit the Showroom Locator section of our website, wolfappliance.com.



PLANNING INFORMATION

The illustrations provide the overall dimensions and finished cut-out dimensions that you need to plan for in your installation. We have minimized the information contained in the illustrations, concentrating on the critical information you need to plan your installation.

IMPORTANT NOTE: When multiple cooktops or modules are installed side by side, refer to page 55 for countertop cut-out dimensions.

The grill module can accommodate a Wolf cooktop hood or Pro ventilation hood or hood liner. When installing a ventilation hood, refer to the specific requirements of the hood for the minimum dimension to the countertop. Refer to pages 92-114 for ventilation specifications.

IMPORTANT NOTE: Wolf does not recommend the use of downdraft ventilation with the grill module.

ELECTRICAL REQUIREMENTS

The Wolf electric grill module requires a separate, grounded 3-wire 240/208 V AC, 60 Hz, 15 amp service with its own circuit breaker. Locate electrical within the shaded area shown in the illustration.

You must follow all National Electrical Code regulations. In addition, be aware of local codes and ordinances when installing your service.

INSTALLATION SPECIFICATIONS

Model IG15/S

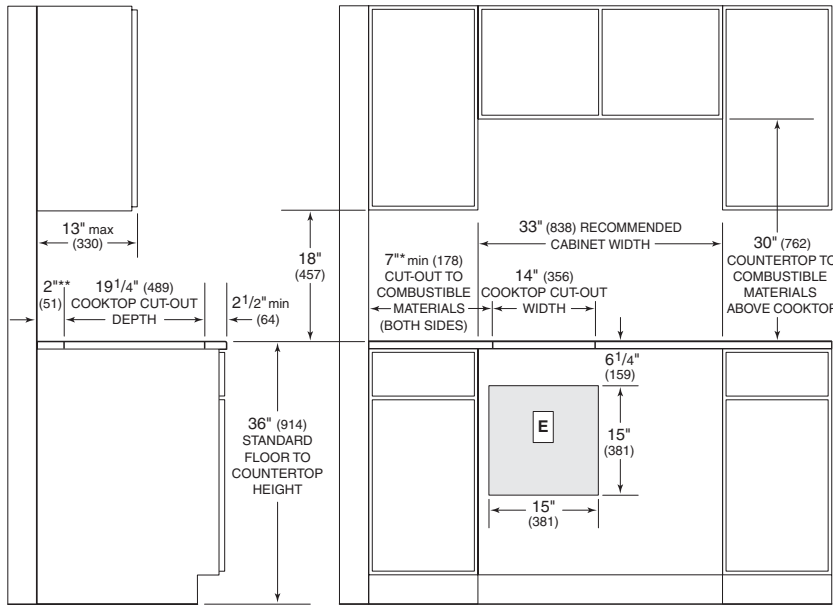

NOTE: Application shown allows for installation of two 15" (381) modules side-by-side with 33" (838) recommended cabinet width. 18" (457) recommended cabinet width for installation of single 15" (381) cooktop or module. *Minimum clearance from both side edges of cooktop cut-out to combustible materials up to 18" (457) above countertop. **Minimum clearance from rear edge of cooktop cut-out to combustible materials up to 18" (457) above countertop.

Countertop Cut-Out Dimensions

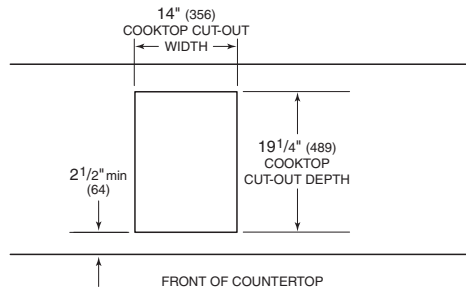

SPECIFICATIONS

Model IG15/S

Electric Grill Module

Exterior Finish	Classic
Overall Width	15" (381)
Overall Height	6 1/4" (159)
Overall Depth	21" (533)
Temperature Zones	Two
Heating Element Zone (front)	1400 W
Heating Element Zone (rear)	1400 W
Total Element Power	2800 W
Cabinet Depth	22 3/4" (578) min
Height Clearance	6 1/4" (159) min
Cut-Out Width	14" (356)
Cut-Out Depth	19 1/4" (489)
Electrical Supply	240/208 V AC, 60 Hz 15 amp circuit
Conduit	4' (1.2 m) flexible 3-wire
Electrical Rating	2.8 kW at 240 V 2.1 kW at 208 V
Shipping Weight	50 lbs (28 kg)

Unit dimensions may vary to ±1/8" (3).

Refer to installation instructions shipped with each Wolf product for detailed specifications.

ELECTRIC STEAMER MODULE



Model IS15/S
Electric Steamer
Module

From a temperature of 140°F (60°C) to boil, you can keep food hot for long periods of time or defrost easily without drying out or losing flavor.

The beauty of this steamer module is accented by the sculptured glass domed lid, which is easily inverted for storage to keep a low profile.

The deep, large vessel with a two-gallon (7.6 L) capacity can hold up to 14 cups of cooked pasta. Includes one solid and one perforated stackable insert pan.

The diversity of our electric steamer includes slow cooking, double boiling, steaming eggs, steaming custard, proofing bread dough, warming food and melting chocolate as well as steaming vegetables.

The Wolf electric steamer module is available in classic stainless steel.

⚠ WARNING

This steamer module must be installed at least 15" (381) away from a Wolf fryer module, as contact between water and hot oil may cause burns from steam and hot oil.

FEATURES

- Integrated** design allows for installation of multiple cooktops or modules
- Stainless** steel top construction with classic stainless steel finish
- Hidden** 2600-watt heating element
- Illuminated** electronic touch controls with graduated control lighting
- Large** two-gallon (7.6 L) maximum capacity tub—10-cup capacity for steaming
- Two** stackable stainless steel steamer insert pans—one solid and one perforated
- Uses** include steaming vegetables, eggs and custard, double boiling, proofing bread dough, warming food and melting chocolate
- Can** function as a slow cooker for 8–10 hours
- Reversible** domed glass lid for easy storage
- Independent** digital timer
- Digital** temperature readout and preheat indicator
- Electronic** drain
- CSA** certified for US and Canada

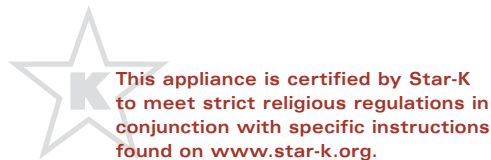

WOLF WARRANTY

Wolf products are covered by a two and five year residential warranty (exclusions apply). See warranty details at the end of this guide.

ELECTRIC STEAMER FEATURES

Model IS15/S

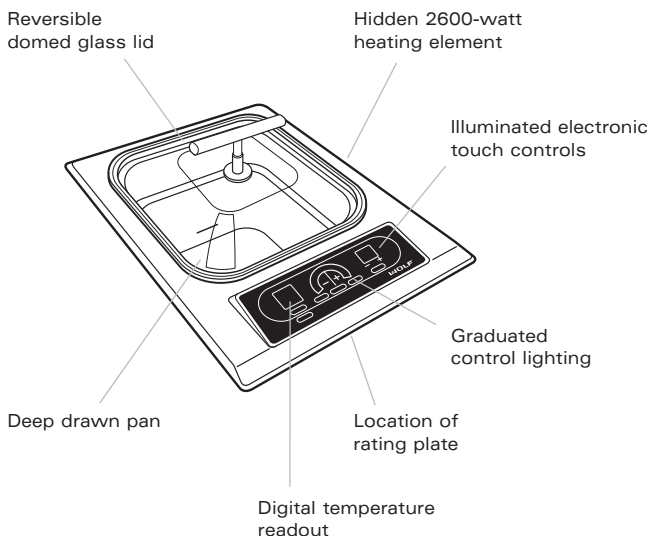

OVERALL DIMENSIONS

Model IS15/S

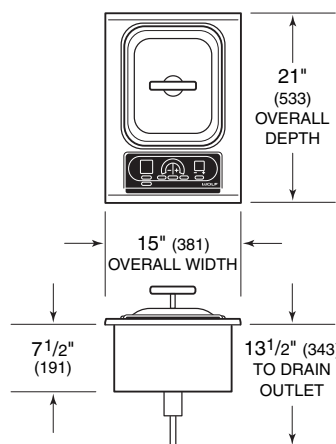

ACCESSORIES

Electric Steamer Module

Filler strip

Accessories are available through your Wolf dealer. To obtain local dealer information, visit the Showroom Locator section of our website, wolfappliance.com.

Dimensions in parentheses are in millimeters unless otherwise specified.



PLANNING INFORMATION

The illustrations provide the overall dimensions and finished cut-out dimensions that you need to plan for in your installation.

IMPORTANT NOTE: When multiple cooktops or modules are installed side by side, refer to page 55 for countertop cut-out dimensions.

For the drain connection, the 5/8" (16) outlet from the valve will accept a drain hose that must flow downward to, and tie into, an existing sink drain. A separate drain with a freefall may also be installed. (Following local building codes, your plumber will dictate how to plumb the unit.) As a third option, the consumer will supply a heat resistant bucket for drainage in the location of the drain outlet. Refer to the illustration for location of the drain outlet.

The steamer module can accommodate a Wolf cooktop hood or Pro ventilation hood or hood liner. When installing a ventilation hood, refer to the specific requirements of the hood for the minimum dimension to the countertop. Refer to pages 92–114 for ventilation specifications.

IMPORTANT NOTE: Wolf does not recommend the use of downdraft ventilation with the steamer module.

ELECTRICAL REQUIREMENTS

The Wolf electric steamer module requires a separate, grounded 3-wire 240/208 V AC, 60 Hz, 15 amp service with its own circuit breaker. Locate electrical within the shaded area shown.

You must follow all National Electrical Code regulations. In addition, be aware of local codes and ordinances when installing your service.

INSTALLATION SPECIFICATIONS

Model IS15/S

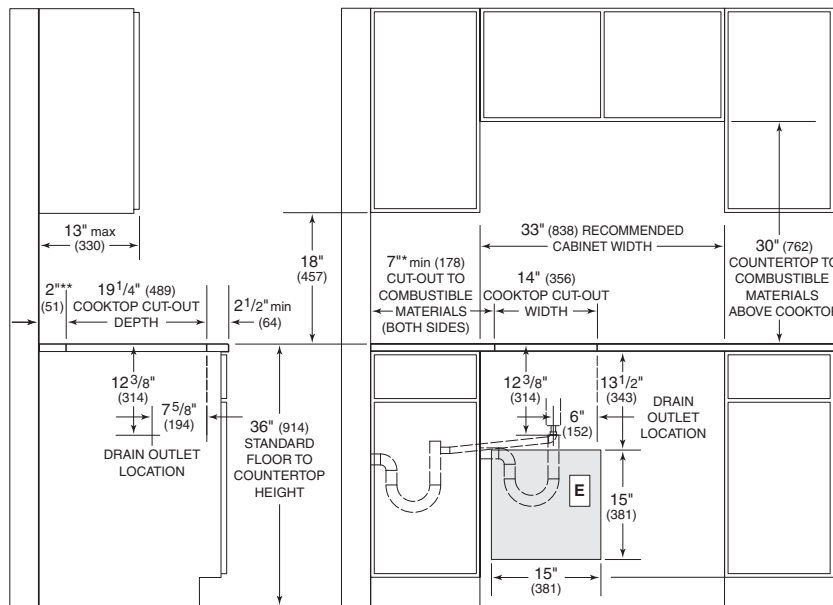

NOTE: Application shown allows for installation of two 15" (381) modules side-by-side with 33" (838) recommended cabinet width. 18" (457) recommended cabinet width for installation of single 15" (381) cooktop or module. *Minimum clearance from both side edges of cooktop cut-out to combustible materials up to 18" (457) above countertop. **Minimum clearance from rear edge of cooktop cut-out to combustible materials up to 18" (457) above countertop.

Countertop Cut-Out Dimensions

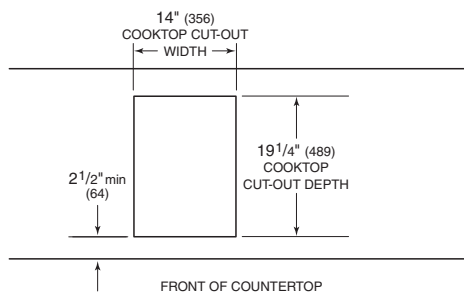

SPECIFICATIONS

Model IS15/S

Electric Steamer Module

Exterior Finish	Classic
Overall Width	15" (381)
Overall Height	13 1/2" (343)
Overall Depth	21" (533)
Heating Element	2600 W
Cabinet Depth	22 3/4" (578) min
Height Clearance	13 1/2" (343) min
Cut-Out Width	14" (356)
Cut-Out Depth	19 1/4" (489)
Electrical Supply	240/208 V AC, 60 Hz 15 amp circuit
Conduit	4' (1.2 m) flexible 3-wire
Electrical Rating	2.6 kW at 240 V 1.9 kW at 208 V
Shipping Weight	40 lbs (18 kg)

Unit dimensions may vary to ±1/8" (3).

⚠ WARNING

This steamer module must be installed at least 15" (381) away from a Wolf fryer module, as contact between water and hot oil may cause burns from steam and hot oil.

Refer to installation instructions shipped with each Wolf product for detailed specifications.



ELECTRIC FRYER MODULE

To round out your options for the ideal kitchen, you can choose a fryer, and Wolf offers a great option that the market has never seen. When your clients use this module, they'll be able to create dinner specialties never tried before.

The accurate temperature control will enable your customer to seal in that great flavor of the food without absorbing any unnecessary grease. The fryer can handle a variety of foods at a wide range of oil temperatures.

The Wolf fryer module is available in classic stainless steel. In addition, there is a metal storage lid to keep the grease area free from particles falling into the fryer.

⚠ WARNING

This fryer module must be installed at least 15" (381) away from any open flame cooking device. The open flame may cause ignition of oil.

⚠ WARNING

This fryer module must be installed at least 15" (381) away from a Wolf steamer module, as contact between water and hot oil may cause burns from steam and hot oil.

FEATURES

Integrated design allows for installation of multiple cooktops or modules

Stainless steel top construction with classic stainless steel finish

Hidden 2600-watt heating element

Illuminated electronic touch controls with graduated control lighting

Large 1 1/4 gallon (3.8 L) capacity tub

Three baskets included—one large and two small side by side, each with wire basket hanger

Low-profile lid

Melt feature for shortening or lard

Independent digital timer

Digital temperature readout and preheat indicator

Easy manual locking drain capability

Recommended for installation with any Wolf framed electric cooktop or the Wolf electric grill module

CSA certified for US and Canada



Model IF15/S
Electric Fryer Module

WOLF WARRANTY

Wolf products are covered by a two and five year residential warranty (exclusions apply). See warranty details at the end of this guide.

Dimensions in parentheses are in millimeters unless otherwise specified.

ELECTRIC FRYER FEATURES

Model IF15/S

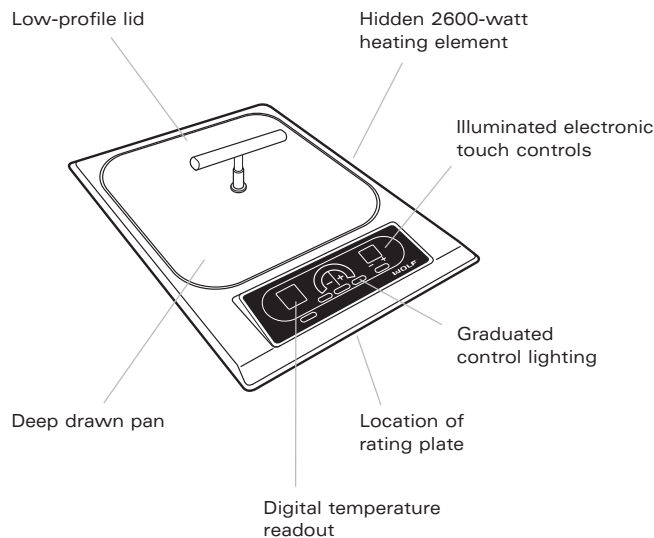

OVERALL DIMENSIONS

Model IF15/S

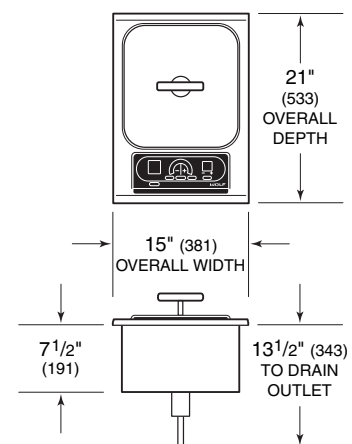

ACCESSORIES

Electric Fryer Module

Filler strip

Accessories are available through your Wolf dealer. To obtain local dealer information, visit the Showroom Locator section of our website, wolfappliance.com.



PLANNING INFORMATION

The illustrations provide the overall dimensions and finished cut-out dimensions that you need to plan for in your installation.

IMPORTANT NOTE: When multiple cooktops or modules are installed side by side, refer to page 55 for countertop cut-out dimensions.

The electric fryer module must be installed in a base cabinet with access to the bottom of the unit to drain the oil through a manual valve. The consumer must supply a heat resistant bucket to accept the drained oil. Refer to the illustration for location of the drain outlet.

The fryer module can accommodate a Wolf cooktop hood or Pro ventilation hood or hood liner. When installing a ventilation hood, refer to the specific requirements of the hood for the minimum dimension to the countertop. Refer to pages 92–114 for ventilation specifications.

IMPORTANT NOTE: Wolf does not recommend the use of downdraft ventilation with the fryer module.

ELECTRICAL REQUIREMENTS

The Wolf electric fryer module requires a separate, grounded 3-wire 240/208 V AC, 60 Hz, 15 amp service with its own circuit breaker. Locate electrical within the shaded area shown in the illustration.

You must follow all National Electrical Code regulations. In addition, be aware of local codes and ordinances when installing your service.

Refer to installation instructions shipped with each Wolf product for detailed specifications.

INSTALLATION SPECIFICATIONS

Model IF15/S

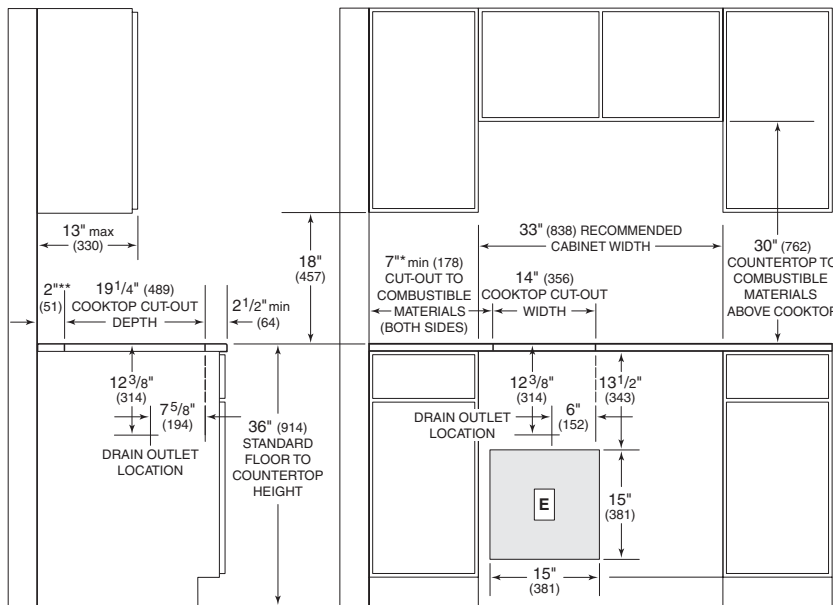

NOTE: Application shown allows for installation of two 15" (381) modules side-by-side with 33" (838) recommended cabinet width. 18" (457) recommended cabinet width for installation of single 15" (381) cooktop or module. *NOTE:* Fryer module must be installed in a base cabinet with access to manual valve at base of unit to drain oil into heat resistant receptacle. *Minimum clearance from both side edges of cooktop cut-out to combustible materials up to 18" (457) above countertop. **Minimum clearance from rear edge of cooktop cut-out to combustible materials up to 18" (457) above countertop.

Countertop Cut-Out Dimensions

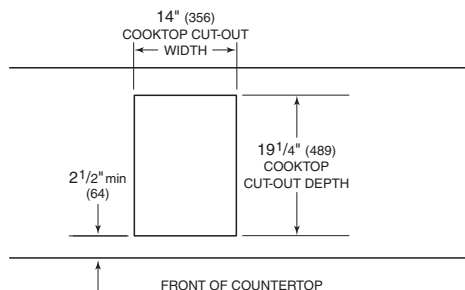

Refer to installation instructions shipped with each Wolf product for detailed specifications.

SPECIFICATIONS

Model IF15/S

Electric Fryer Module

Exterior Finish	Classic
Overall Width	15" (381)
Overall Height	13 1/2" (343)
Overall Depth	21" (533)
Heating Element	2600 W
Cabinet Depth	22 3/4" (578) min
Height Clearance	13 1/2" (343) min
Cut-Out Width	14" (356)
Cut-Out Depth	19 1/4" (489)
Electrical Supply	240/208 V AC, 60 Hz 15 amp circuit
Conduit	4' (1.2 m) flexible 3-wire
Electrical Rating	2.6 kW at 240 V 1.9 kW at 208 V
Shipping Weight	30 lbs (14 kg)

Unit dimensions may vary to ± 1/8" (3).

⚠ WARNING

This fryer module must be installed at least 15" (381) away from any open flame cooking device. The open flame may cause ignition of oil.

⚠ WARNING

This fryer module must be installed at least 15" (381) away from a Wolf steamer module, as contact between water and hot oil may cause burns from steam and hot oil.



GAS MULTI-FUNCTION COOKTOP



Model IM15/S Gas Multi-Function Cooktop

It's really a misnomer to describe this wonderful cooktop module as a wok instrument because it is much more than that. The large, low-profile grate will fit in nicely with any Wolf gas cooktop.

For true wok cooking, the burner sculpts the gas flame into a plume, focusing heat in the center of the wok, then dispersing it outward for precisely controlled cooking. The larger grate will handle your wok perfectly but will also accommodate your largest stockpots and Dutch ovens. The powerful burner exceeds 18,000 Btu/hr (5.1 kW).

The Wolf multi-function cooktop is available in classic stainless steel.

FEATURES

Integrated design allows for installation of multiple cooktops or modules

Available in natural and LP gas

Stainless steel top construction with classic stainless steel finish

High output 18,000 Btu/hr (5.1 kW) dual-stacked sealed burner

Automatic electronic reignition system

Illuminated control panel

Individual spark ignition system

Two interchangeable cast iron burner grates with matte porcelain finish—wok grate and low-profile continuous grate

Deep drawn burner pan

CSA certified for US and Canada

WOLF WARRANTY

Wolf products are covered by a two and five year residential warranty (exclusions apply). See warranty details at the end of this guide.

GAS MULTI-FUNCTION COOKTOP FEATURES

Model IM15/S

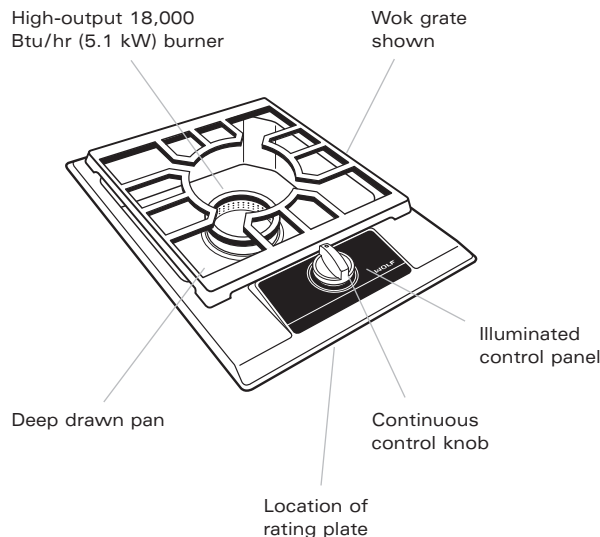

OVERALL DIMENSIONS

Gas Multi-Function Cooktop

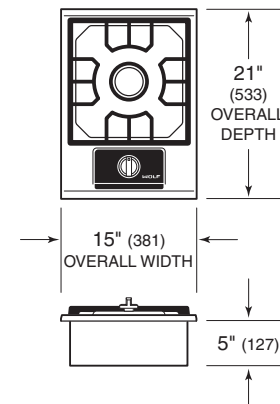

ACCESSORIES

Gas Multi-Function Cooktop

Filler strip

Bracket supports for installation of two integrated modules with downdraft (Model DD30 only)

High altitude conversion kit

Accessories are available through your Wolf dealer. To obtain local dealer information, visit the Showroom Locator section of our website, wolfappliance.com.

Dimensions in parentheses are in millimeters unless otherwise specified.



PLANNING INFORMATION

The illustrations provide the overall dimensions and finished cut-out dimensions that you need to plan for in your installation.

IMPORTANT NOTE: When multiple cooktops or modules are installed side by side, refer to page 55 for countertop cut-out dimensions.

This cooktop can accommodate a Wolf cooktop hood, downdraft system or Pro ventilation hood or hood liner. When installing a ventilation hood, refer to the specific requirements of the hood for the minimum dimension to the countertop. Refer to pages 92-114 for ventilation specifications.

ELECTRICAL | GAS REQUIREMENTS

The electric ignition system is a safe, convenient and reliable way to provide ignition for the burner. The Wolf gas multi-function cooktop requires a separate 120 V AC, 60 Hz power supply.

The service should have its own 15 amp circuit breaker, and a grounded 3-prong receptacle should be located within reach of the power cord. Locate electrical and gas supply within the shaded area shown in the illustration.

IMPORTANT NOTE: A ground fault circuit interrupter (GFCI) is not recommended and may cause interruption of operation.

The gas multi-function cooktop is designed to operate on natural gas at 5" (12.5 mb) WC pressure or LP gas at 10" (25 mb) WC pressure. The maximum gas supply pressure to the regulator should never exceed 14" (34.9 mb) WC, .5 psi (3.5 kPa). It is supplied with a 1/2" NPT male gas connection at the right rear corner of the module. The male connector exits the unit straight down, and you are supplied with a regulator with two female connectors.

HIGH ALTITUDE

The Wolf gas multi-function cooktop functions up to 8,000' (2438 m) in altitude without any adjustment. If installation is above 8,000' (2438 m), contact your Wolf dealer.

INSTALLATION SPECIFICATIONS

Gas Multi-Function Cooktop

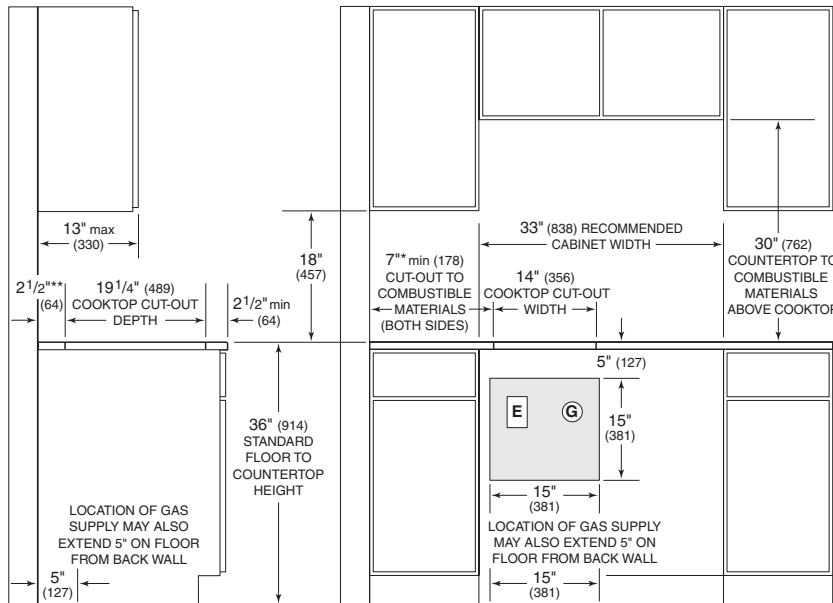

NOTE: Application shown allows for installation of two 15" (381) modules side-by-side with 33" (838) recommended cabinet width. 18" (457) recommended cabinet width for installation of single 15" (381) cooktop or module. *Minimum clearance from both side edges of cooktop cut-out to combustible materials up to 18" (457) above countertop. **Minimum clearance from rear edge of cooktop cut-out to combustible materials up to 18" (457) above countertop.

Countertop Cut-Out Dimensions

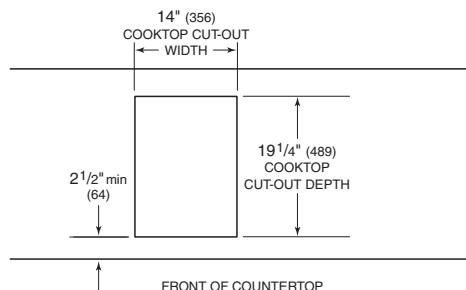

MODEL OPTIONS

Gas Multi-Function Cooktop

- Classic / Natural Gas **IM15/S**
- Classic / LP Gas **IM15/S-LP**

SPECIFICATIONS

Gas Multi-Function Cooktop

- Overall Width **15" (381)**
- Overall Height **5" (127)**
- Overall Depth **21" (533)**
- Burner Rating **18,000 Btu/hr (5.1 kW)**
- Cabinet Depth **22 3/4" (578) min**
- Height Clearance* **5" (127) min**
- Cut-Out Width **14" (356)**
- Cut-Out Depth **19 1/4" (489)**
- Electrical Supply **120 V AC, 60 Hz
15 amp circuit**
- Power Cord **6' (1.8 m) 3-prong**
- Gas Rating **18,000 Btu/hr (5.1 kW)**
- Shipping Weight **30 lbs (14 kg)**

*A minimum height clearance of 5 1/2" (140) is required between countertop and any combustible surface directly below the cooktop. Unit dimensions may vary to ± 1/8" (3).

Refer to installation instructions shipped with each Wolf product for detailed specifications.



TOP CONFIGURATIONS

Dual Fuel Ranges

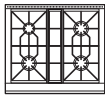

DF304

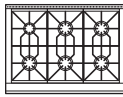

DF366

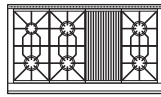

DF486C

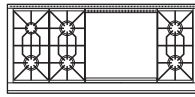

DF606DG

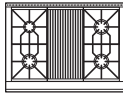

DF364C

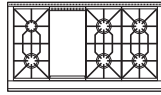

DF486G

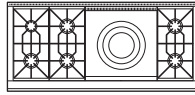

DF606F

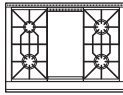

DF364G

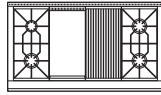

DF484CG

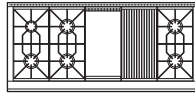

DF606CG

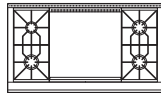

DF484DG

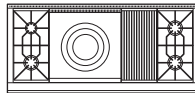

DF604CF

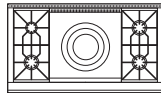

DF484F

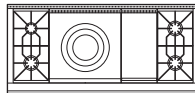

DF604GF

WOLF DUAL FUEL RANGES

With Wolf's dual fuel ranges you have state-of-the-art cooking expertise in any number of sizes to meet the discriminating consumer's precise needs. Patented features ensure this range stands out from the rest in performance and also beauty.

Wolf dual fuel ranges come in 30" (762), 36" (914), 48" (1219) and 60" (1524) widths. Combined with the top configuration options, the different configurations you can choose from are numerous. Model numbers indicate the top configurations: (C) charbroiler, (G) griddle, (DG) double griddle and (F) French Top. All Wolf dual fuel ranges come in the classic stainless steel finish.

The electric oven(s) feature the Wolf exclusive dual convection system that delivers even temperature and airflow throughout. Its combination of convection fans and heating elements give the user convenience and superior control over ten different cooking modes.

Advanced standard features such as dual-stacked sealed burners, dual convection fans, cobalt blue porcelain oven interior, pivoting control panel, along with the Wolf exclusive infrared charbroiler, infrared griddle and French Top are all yours for the asking. The freedom to customize your dual fuel range will make you and your client look great.



This appliance is certified by Star-K to meet strict religious regulations in conjunction with specific instructions found on www.star-k.org.

Dimensions in parentheses are in millimeters unless otherwise specified.

COOKING MODES

- Bake
- Roast
- Broil
- Convection Bake
- Convection Roast
- Convection Broil
- Convection
- Bake Stone*
- Dehydrate*
- Proof

*Accessory required.



FEATURES

- Natural** or LP gas rangetop with dual convection electric oven(s)
- 18" (457)** oven on 48" (1219) range is single convection
- Optional** infrared charbroiler, infrared griddle and French Top configurations
- Classic** stainless steel exterior finish with island trim included
- Distinctive** red or black control knobs
- Platinum** bezels surround all knobs—chrome or brass bezels optional
- Dual-stacked**, sealed surface burners, all with simmer capabilities and automatic reignition at all settings
- 15,000** Btu/hr (4.4 kW) burners with 950 Btu/hr (.3 kW) delivered at simmer
- 9,200** Btu/hr (2.7 kW) burner with 325 Btu/hr (.1 kW) delivered at simmer and melt feature
- Porcelain-coated** cast iron continuous top grates

- Pivoting** hidden touch control panel
- Ten** cooking modes
- Self-cleaning** oven(s) with cobalt blue porcelain oven interior
- Coaxial** temperature-displaying oven selector knob
- Proof** mode for 18" (457) oven on 48" (1219) range
- Temperature** probe and dehydration feature
- Three** removable oven racks, six-level rack guide and full-extension bottom rack
- Hidden** bake element and recessed broil element
- Triple-pane** oven door window(s) and dual halogen lighting
- Spring/Damper** door system on oven door(s)
- Adjustable** stainless steel legs in front and adjustable rear casters
- CSA** certified for US and Canada

WOLF
WARRANTY

Wolf products are covered by a two and five year residential warranty (exclusions apply). See warranty details at the end of this guide.

DUAL FUEL RANGE FEATURES

Model DF484CG shown

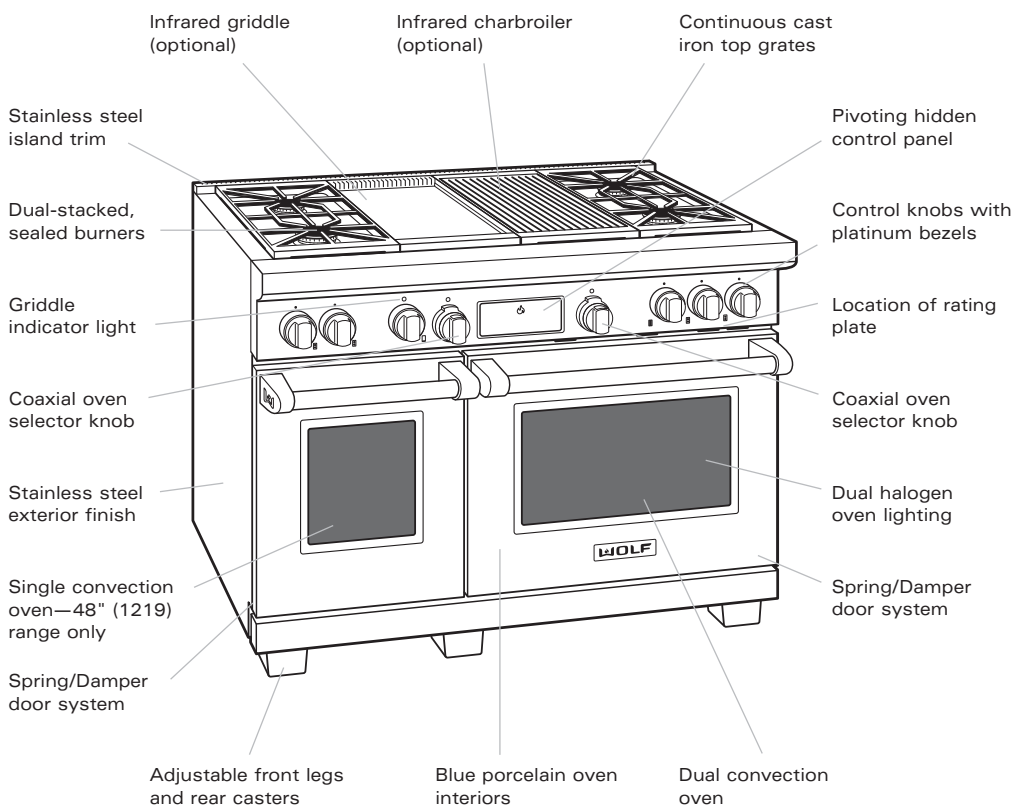

ACCESSORIES

Dual Fuel Ranges

- 5" (127) and 10" (254) classic stainless steel risers**
- 20" (508) classic stainless steel riser with shelf**
- Red or black control knobs—must be ordered with the range**
- Chrome or brass bezels**
- One-piece wok grate and single burner grate**
- Porcelain-cast two-burner S-grate**
- Two-piece broiler pan and temperature probe**
- Additional oven racks**
- Hardwood cutting board—griddle models only**
- Bake stone accessory**
- Dehydration accessory**
- Front leg extension covers and rear leg caster covers**
- High altitude conversion kit**

Accessories are available through your Wolf dealer. To obtain local dealer information, visit the Showroom Locator section of our website, wolfappliance.com.



PLANNING INFORMATION

Wolf dual fuel ranges come in 30" (762), 36" (914), 48" (1219) and 60" (1524) widths. Specifications on the following pages provide overall dimensions, finished rough opening dimensions and installation specifics for each size of dual fuel range. We have minimized the information contained in the illustrations, concentrating on the critical information you need to plan your installation.

IMPORTANT NOTE: Caution must be used in planning the proper installation of the Wolf dual fuel range to avoid fires or damage to adjacent cabinetry or kitchen equipment. Please follow the minimum clearances established in the finished rough opening dimensions. Refer to specifications on the following pages for your model.

It is recommended that you use a Wolf Pro ventilation hood or hood liner with the Wolf dual fuel range. Refer to pages 102–114 for Pro ventilation specifications.

ELECTRICAL | GAS REQUIREMENTS

Specifications on the following pages provide electrical and gas requirements for each size of dual fuel range.

Locate electrical and gas supply within the shaded area shown in the Installation Specifications illustration for your model.

Wolf dual fuel ranges are designed with a terminal block on the rear of the range. The terminal block allows for a 3-wire or 4-wire installation. For a 4-wire installation, the ground strap from the unit to the terminal block must be cut. Two concentric knockouts on the base of the unit are provided to allow a certified electrical contractor to wire the range directly to the electrical supply. The terminal block will also accept an appliance cord that is sized correctly for the voltage and amperage of your range.

Wolf dual fuel ranges are designed to operate on natural gas at 5" (12.5 mb) WC (water column) pressure or LP (propane) gas at 10" (25 mb) WC pressure. The minimum line pressure for natural gas is 7" (17.5 mb) WC and 11" (27.4 mb) WC for LP gas. The maximum gas supply pressure to the regulator should never exceed 14" (34.9 mb) WC, .5 psi (3.5 kPa).

Wolf recommends the use of a 1/2" (13) I.D. commercial-type flex hose; this is the minimum size that may be used. All plumbing to the flex hose **must** be 3/4" (19) minimum I.D. pipe.

IMPORTANT NOTE: A separate external gas shut-off valve must be located near the range in an accessible location.

You must follow all National Electrical Code and gas regulations. In addition, be aware of local codes and ordinances when installing your services.

HIGH ALTITUDE

Wolf dual fuel ranges using natural gas function up to an altitude of 8,000' (2438 m) without any adjustment. Natural gas and LP gas installations from 8,000' (2438 m) to 11,000' (3353 m) need the high altitude kit. Contact your Wolf dealer for details.

BURNER RATING

Dual Fuel Ranges

Surface Burners	15,000 Btu/hr (4.4 kW) with 950 Btu/hr (.3 kW) delivered at simmer (1) 9,200 Btu/hr (2.7 kW) with 325 Btu/hr (.1 kW) delivered at simmer
Infrared Charbroiler	16,000 Btu/hr (4.7 kW)
Infrared Griddle	
Natural Gas	15,000 Btu/hr (4.4 kW)
LP Gas	13,000 Btu/hr (3.8 kW)
Infrared Double Griddle	
Natural Gas	(2) 15,000 Btu/hr (4.4 kW)
LP Gas	(2) 13,000 Btu/hr (3.8 kW)
French Top	15,000 Btu/hr (4.4 kW)

Refer to the specific model requirements for risers in non-island installations.

Dimensions in parentheses are in millimeters unless otherwise specified.



OVERALL DIMENSIONS
30" (762) Dual Fuel Range

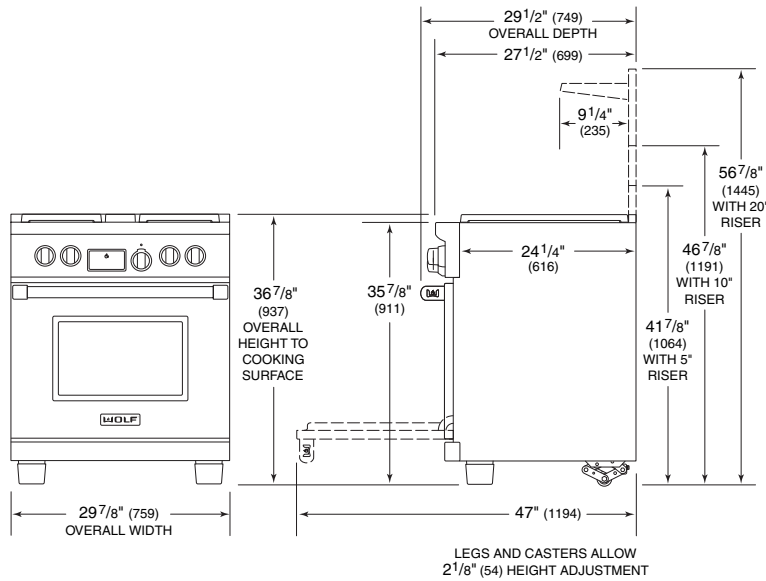

SPECIFICATIONS
30" (762) Dual Fuel Range

Overall Width	29 7/8" (759)
Overall Height (to cooking surface)	36 7/8" (937)
Overall Depth	29 1/2" (749)
Overall Oven Interior Capacity	4.5 cu ft (127 L)
Overall Interior Dim (W x H x D)	25" x 16 1/2" x 19" (635 x 419 x 483)
Usable Interior Dim (W x H x D)	21 1/2" x 16 1/2" x 16 3/8" (546 x 419 x 416)
Opening Width	30" (762)
Electrical Supply	240/208 V AC, 60 Hz 30 amp circuit
Electrical Rating	5.2 kW at 240 V 4.5 kW at 208 V
Total Amps	21.7
Shipping Weight	325 lbs (147 kg)

Unit dimensions may vary to ±1/8" (3).

INSTALLATION SPECIFICATIONS
30" (762) Dual Fuel Range

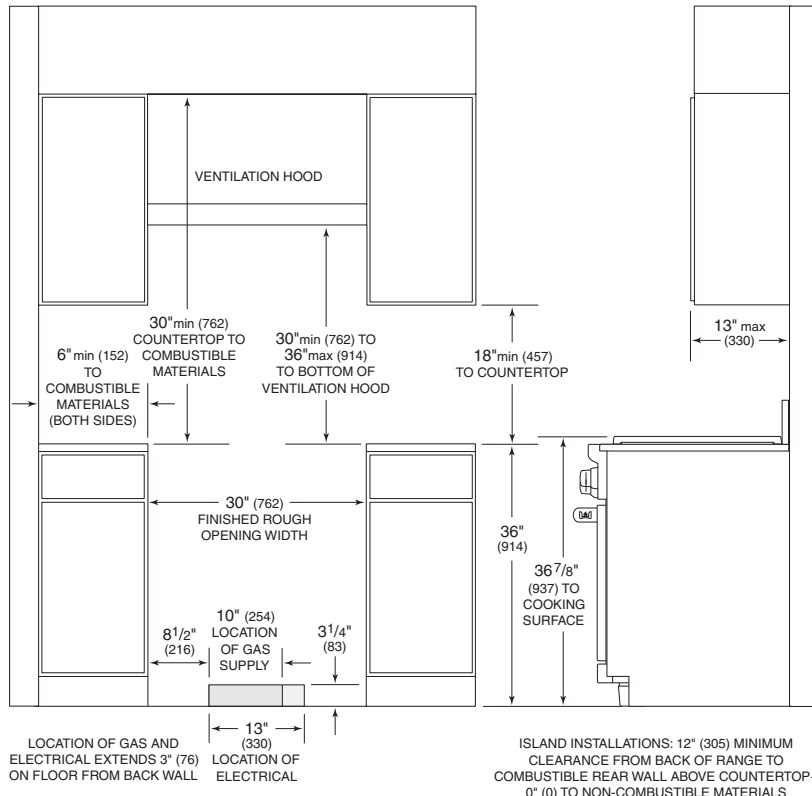

MODEL OPTIONS
30" (762) Dual Fuel Range

Four Surface Burners DF304

Natural gas model listed; for LP gas add (-LP) to the model number.

Refer to installation instructions shipped with each Wolf product for detailed specifications.



WOLF DUAL FUEL RANGES

OVERALL DIMENSIONS 36" (914) Dual Fuel Range

SPECIFICATIONS

36" (914) Dual Fuel Range

Overall Width	35⁷/₈" (911)
Overall Height (to cooking surface)	36⁷/₈" (937)
Overall Depth	29¹/₂" (749)
Overall Oven Interior Capacity	5.4 cu ft (153 L)
Overall Interior Dim (W x H x D)	30" x 16¹/₂" x 19" (762 x 419 x 483)
Usable Interior Dim (W x H x D)	26¹/₂" x 16¹/₂" x 16³/₈" (673 x 419 x 416)
Opening Width	36" (914)
Electrical Supply	240/208 V AC, 60 Hz 30 amp circuit
Electrical Rating	5.2 kW at 240 V 4.5 kW at 208 V
Total Amps	12.7
Shipping Weight	445-470 lbs (202-213 kg)

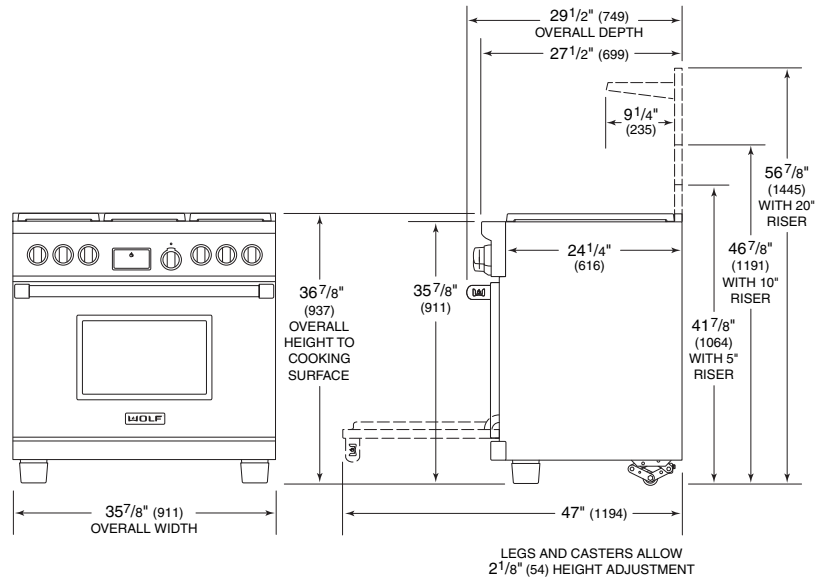

Unit dimensions may vary to ±1/8" (3).

MODEL OPTIONS

36" (914) Dual Fuel Range

- Six Surface Burners** DF366
- Four Surface Burners**
- Charbroiler** DF364C
- Griddle** DF364G

Natural gas models listed; for LP gas add (-LP) to the model number.

IMPORTANT NOTE: A minimum 10" (254) riser is required when installing a 36" (914) dual fuel range with a charbroiler or griddle against a combustible surface.

INSTALLATION SPECIFICATIONS

36" (914) Dual Fuel Range

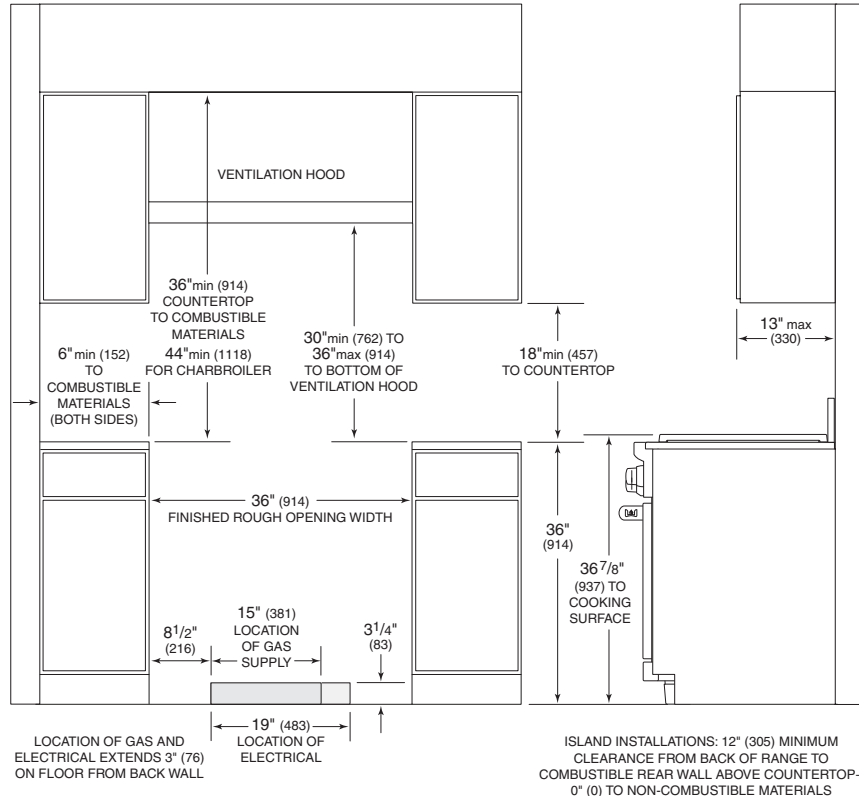

Dimensions in parentheses are in millimeters unless otherwise specified.



OVERALL DIMENSIONS
48" (1219) Dual Fuel Range

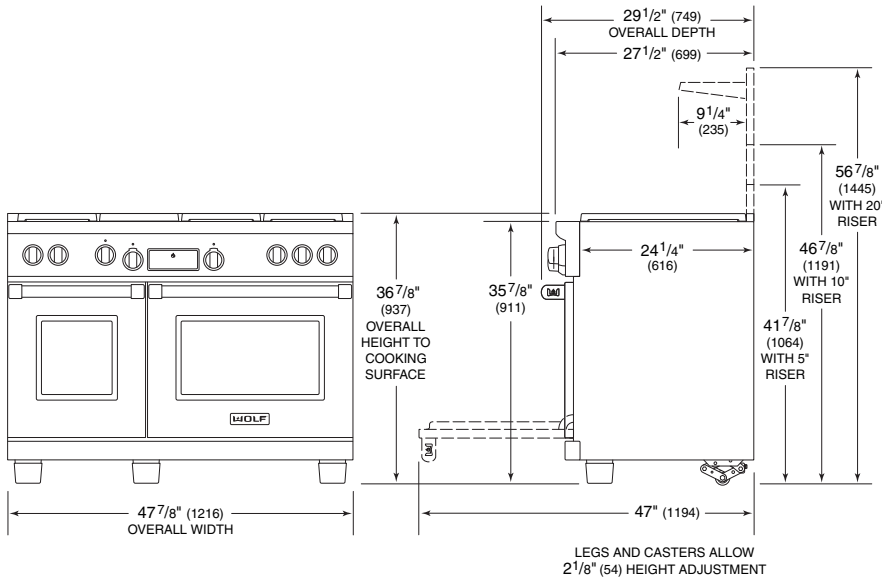

Unit dimensions may vary to ±1/8" (3).

SPECIFICATIONS
48" (1219) Dual Fuel Range

Overall Width	47 7/8" (1216)
Overall Height (to cooking surface)	36 7/8" (937)
Overall Depth	29 1/2" (749)
Large Oven—	
Overall Interior Cap	4.5 cu ft (127 L)
Overall Interior Dim (W x H x D)	25" x 16 1/2" x 19" (635 x 419 x 483)
Usable Interior Dim (W x H x D)	21 1/2" x 16 1/2" x 16 3/8" (546 x 419 x 416)
Small Oven—	
Overall Interior Cap	2.5 cu ft (71 L)
Overall Interior Dim (W x H x D)	14" x 16 1/2" x 19" (356 x 419 x 483)
Usable Interior Dim (W x H x D)	11 5/8" x 16 1/2" x 16 3/8" (295 x 419 x 416)
Opening Width	48" (1219)
Electrical Supply	240/208 V AC, 60 Hz 50 amp circuit
Electrical Rating	10.2 kW at 240 V 8.8 kW at 208 V
Total Amps	42.5
Shipping Weight	665–750 lbs (302–340 kg)

INSTALLATION SPECIFICATIONS
48" (1219) Dual Fuel Range

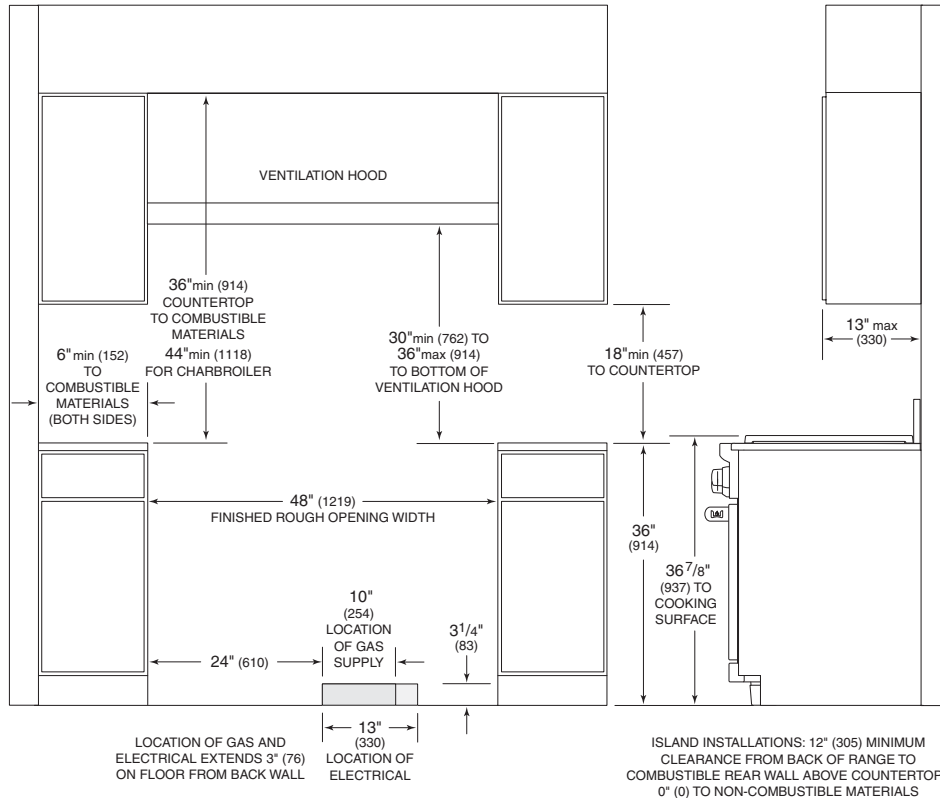

MODEL OPTIONS
48" (1219) Dual Fuel Range

Six Surface Burners	
Charbroiler	DF486C
Griddle	DF486G
Four Surface Burners	
Charbroiler and Griddle	DF484CG
Double Griddle	DF484DG
French Top	DF484F

Natural gas models listed; for LP gas add (-LP) to the model number.

IMPORTANT NOTE: A minimum 10" (254) riser is required for all 48" (1219) dual fuel range models installed against a combustible surface.

Refer to installation instructions shipped with each Wolf product for detailed specifications.



WOLF SEALED BURNER RANGETOPS

There's a good reason why professional chefs choose gas cooking: control. The patented, dual-stacked sealed gas burners of our new sealed burner rangetop take control to a new level. Two levels, really. The upper-tier burner delivers maximum heat transfer at higher settings; the lower-tier continuous flame ably handles the subtleties of simmering and melting.

Patented features along with the Wolf exclusive infrared charbroiler, infrared griddle and French Top ensure this rangetop stands out from the rest in performance as well as beauty.

Wolf sealed burner rangetops come in 30" (762), 36" (914) and 48" (1219) widths and are available in natural or LP gas, with your choice of several top configurations. Model numbers indicate the top configurations: (C) charbroiler, (G) griddle, (DG) double griddle and (F) French Top. The model number followed by (-LP) denotes an LP gas model. All Wolf sealed burner rangetops come in the classic stainless steel finish.

TOP CONFIGURATIONS

Sealed Burner Rangetops

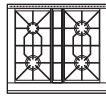

SRT304

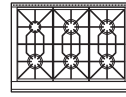

SRT366

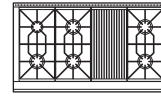

SRT486C

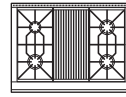

SRT364C

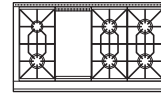

SRT486G

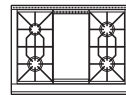

SRT364G

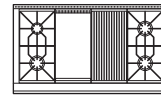

SRT484CG

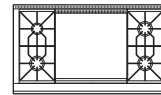

SRT484DG

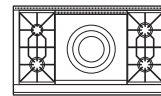

SRT484F



This appliance is certified by Star-K to meet strict religious regulations in conjunction with specific instructions found on www.star-k.org.



FEATURES

Natural or LP gas models

Classic stainless steel exterior finish with island trim

Optional infrared charbroiler, infrared griddle, double griddle and French Top configurations

Distinctive red control knobs—optional black knobs available at no cost

Platinum bezels surround all knobs—chrome or brass bezels optional

Dual-stacked, sealed surface burners, all with simmer capabilities and automatic reignition at all settings

15,000 Btu/hr (4.4 kW) burners with 950 Btu/hr (.3 kW) delivered at simmer

9,200 Btu/hr (2.7 kW) burner with 325 Btu/hr (.1 kW) delivered at simmer and melt feature

Porcelain-coated cast iron continuous top grates

CSA certified for US and Canada

WOLF WARRANTY

Wolf products are covered by a two and five year residential warranty (exclusions apply). See warranty details at the end of this guide.

SEALED BURNER RANGETOP FEATURES

Model SRT484CG shown

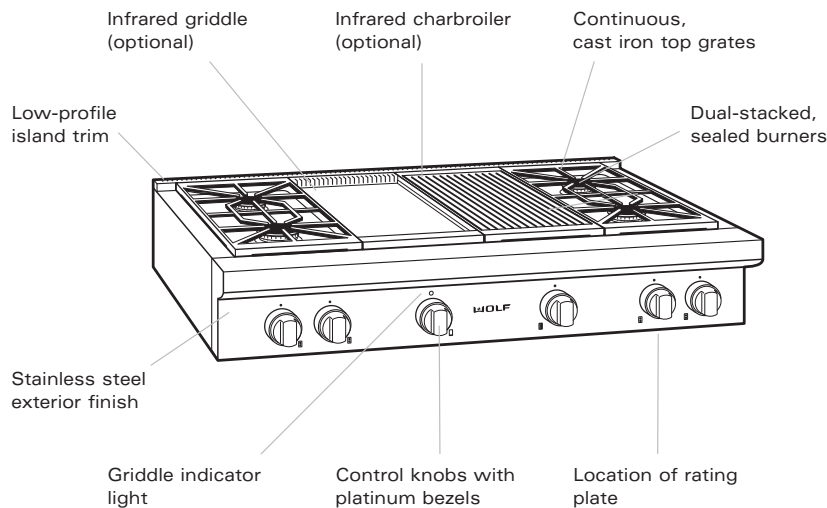

ACCESSORIES

Sealed Burner Rangetops

5" (127) and 10" (254) classic stainless steel risers

20" (508) classic stainless steel riser with shelf

Black control knobs—one set available at no cost

Chrome or brass bezels

One-piece wok grate and single burner grate

Porcelain-cast two-burner S-grate

SRT/Downdraft trim kit—Models SRT304 and SRT366 only

Hardwood cutting board—griddle models only

High altitude conversion kit

Accessories are available through your Wolf dealer. To obtain local dealer information, visit the Showroom Locator section of our website, wolfappliance.com.

Dimensions in parentheses are in millimeters unless otherwise specified.



PLANNING INFORMATION

Wolf sealed burner rangetops come in 30" (762), 36" (914) and 48" (1219) widths. Specifications on the following pages provide overall dimensions, finished rough opening dimensions and installation specifics for each size of sealed burner rangetop. We have minimized the information contained in the illustrations, concentrating on the critical information you need to plan your installation.

IMPORTANT NOTE: Caution must be used in planning the proper installation of the Wolf sealed burner rangetop to avoid fires or damage to adjacent cabinetry or kitchen equipment. Please follow the minimum clearances established in the finished rough opening dimensions. Refer to specifications on the following pages for your model.

It is recommended that you use a Wolf Pro ventilation hood or hood liner with the Wolf sealed burner rangetop. Refer to pages 102–114 for Pro ventilation specifications. A downdraft can be used with Models SRT304 and SRT366. An accessory trim kit is necessary for this installation. Contact your Wolf dealer for details.

BURNER RATING

Sealed Burner Rangetops

Surface Burners	15,000 Btu/hr (4.4 kW) with 950 Btu/hr (.3 kW) delivered at simmer (1) 9,200 Btu/hr (2.7 kW) with 325 Btu/hr (.1 kW) delivered at simmer
Infrared Charbroiler	16,000 Btu/hr (4.7 kW)
Infrared Griddle	
Natural Gas	15,000 Btu/hr (4.4 kW)
LP Gas	13,000 Btu/hr (3.8 kW)
Infrared Double Griddle	
Natural Gas	(2) 15,000 Btu/hr (4.4 kW)
LP Gas	(2) 13,000 Btu/hr (3.8 kW)
French Top	15,000 Btu/hr (4.4 kW)

Refer to the specific model requirements for risers in non-island installations.

ELECTRICAL | GAS REQUIREMENTS

Specifications on the following pages provide electrical and gas requirements for each size of sealed burner rangetop.

The Wolf sealed burner rangetop requires a 110/120 V AC, 50/60 Hz electrical supply to operate the electronic ignition system. The power supply cord is equipped with a 3-prong, grounded plug for protection against shock hazard. The service should have its own 15 amp circuit breaker.

IMPORTANT NOTE: A ground fault circuit interrupter (GFCI) is not recommended and may cause interruption of operation.

Wolf sealed burner rangetops are designed to operate on natural gas at 5" (12.5 mb) WC (water column) pressure or LP (propane) gas at 10" (25 mb) WC pressure. The minimum line pressure for natural gas is 7" (17.5 mb) WC and 11" (27.4 mb) WC for LP gas. The maximum gas supply pressure to the regulator should never exceed 14" (34.9 mb) WC, .5 psi (3.5 kPa).

If local codes permit, a certified, 3' (.9 m) long, 1/2" or 3/4" I.D. flexible metal appliance connector is recommended for connecting the rangetop to the gas supply line.

IMPORTANT NOTE: A separate external gas shut-off valve must be located near the rangetop in an accessible location.

The platform for the rangetop must be 3/4" (19) thick and include a cut-out at the right rear for gas supply and electrical connections.

Locate electrical and gas supply within the shaded area shown in the Installation Specifications illustration for your model.

You must follow all National Electrical Code and gas regulations. In addition, be aware of local codes and ordinances when installing your services.

HIGH ALTITUDE

Wolf sealed burner rangetops using natural gas function up to an altitude of 8,000' (2438 m) without any adjustment. Natural gas and LP gas installations from 8,000' (2438 m) to 11,000' (3353 m) need the high altitude kit. Contact your Wolf dealer for details.



WOLF SEALED BURNER RANGETOPS

OVERALL DIMENSIONS

30" (762) Sealed Burner Rangetop

SPECIFICATIONS

30" (762) Sealed Burner Rangetop

Overall Width	29⁷/₈" (759)
Overall Height (to cooking surface)	8¹/₂" (216)
Overall Depth	28¹/₂" (724)
Opening Width	30" (762)
Opening Height (platform to countertop)	7¹/₂" (191)
Opening Depth	24" (1219)
Electrical Supply	110/120 V AC 50/60 Hz 15 amp circuit
Power Cord	6' (1.8 m) 3-prong
Shipping Weight	160 lbs (73 kg)

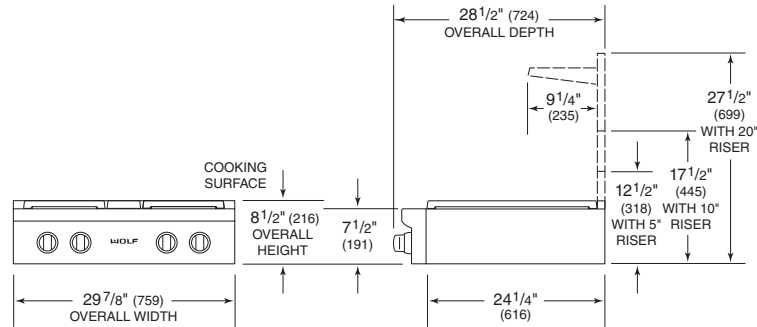

Unit dimensions may vary to ±1/8" (3).

MODEL OPTIONS

30" (762) Sealed Burner Rangetops

Four Surface Burners **SRT304**

Natural gas model listed; for LP gas add (-LP) to the model number.

INSTALLATION SPECIFICATIONS

30" (762) Sealed Burner Rangetop

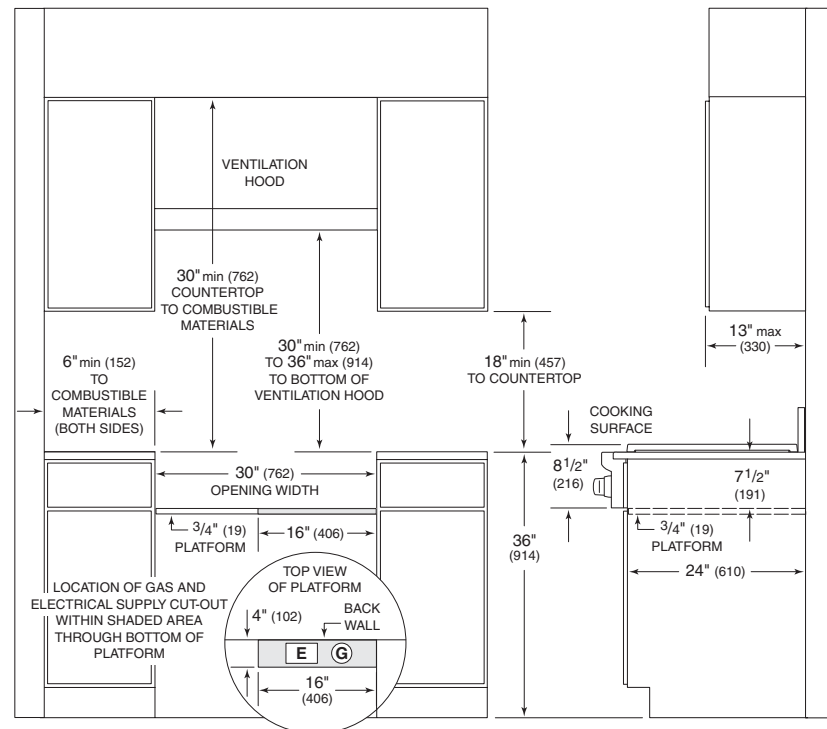

ISLAND INSTALLATIONS: 12" (305) MINIMUM CLEARANCE FROM BACK OF RANGETOP TO COMBUSTIBLE REAR WALL ABOVE COUNTERTOP- 0" (0) TO NON-COMBUSTIBLE MATERIALS

Dimensions in parentheses are in millimeters unless otherwise specified.



OVERALL DIMENSIONS

36" (914) Sealed Burner Rangetop

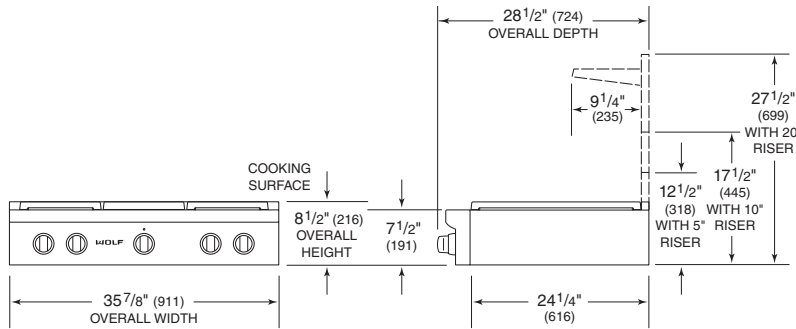

SPECIFICATIONS

36" (914) Sealed Burner Rangetop

Overall Width	35 7/8" (911)
Overall Height (to cooking surface)	8 1/2" (216)
Overall Depth	28 1/2" (724)
Opening Width	36" (914)
Opening Height (platform to countertop)	7 1/2" (191)
Opening Depth	24" (1219)
Electrical Supply	110/120 V AC 50/60 Hz 15 amp circuit
Power Cord	6' (1.8 m) 3-prong
Shipping Weight	190-220 lbs (86-100 kg)

Unit dimensions may vary to ±1/8" (3).

INSTALLATION SPECIFICATIONS

36" (914) Sealed Burner Rangetop

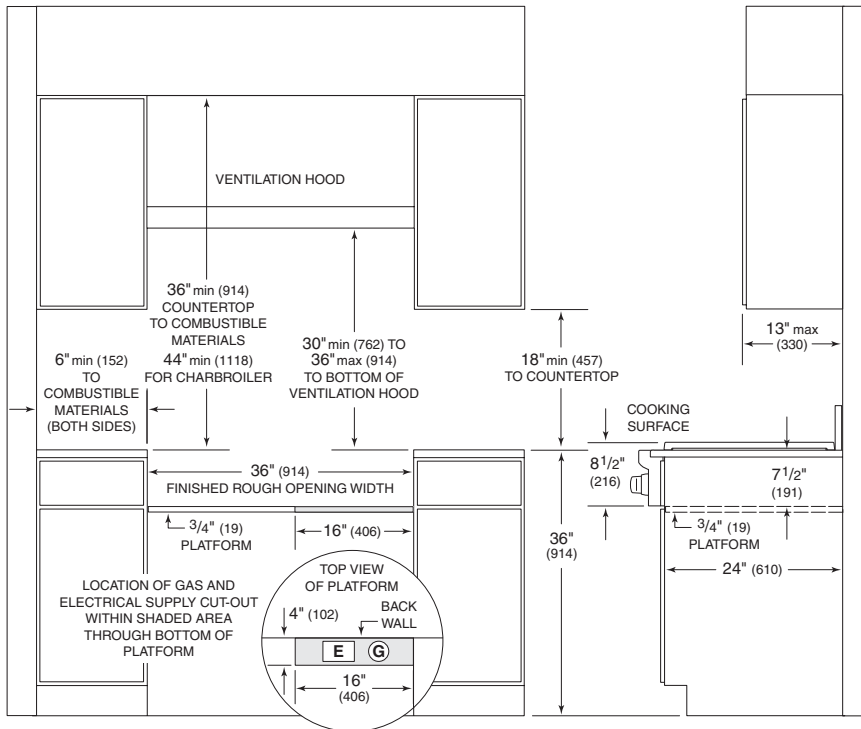

MODEL OPTIONS

36" (914) Sealed Burner Rangetops

Six Surface Burners	SRT366
Four Surface Burners	
Charbroiler	SRT364C
Griddle	SRT364G

Natural gas models listed; for LP gas add (-LP) to the model number.

IMPORTANT NOTE: A minimum 5" (127) riser is required when installing Model SRT366 against a combustible surface. A minimum 10" (254) riser is required for charbroiler (C) or griddle (G) models installed against a combustible surface.

ISLAND INSTALLATIONS: 12" (305) MINIMUM CLEARANCE FROM BACK OF RANGETOP TO COMBUSTIBLE REAR WALL ABOVE COUNTERTOP- 0" (0) TO NON-COMBUSTIBLE MATERIALS

Refer to installation instructions shipped with each Wolf product for detailed specifications.



WOLF SEALED BURNER RANGETOPS

OVERALL DIMENSIONS

48" (1219) Sealed Burner Rangetop

SPECIFICATIONS

48" (1219) Sealed Burner Rangetop

Overall Width	47⁷/₈" (1216)
Overall Height (to cooking surface)	8¹/₂" (216)
Overall Depth	28¹/₂" (724)
Opening Width	48" (1219)
Opening Height (platform to countertop)	7¹/₂" (191)
Opening Depth	24" (1219)
Electrical Supply	110/120 V AC 50/60 Hz 15 amp circuit
Power Cord	6' (1.8 m) 3-prong
Shipping Weight	240-280 lbs (109-127 kg)

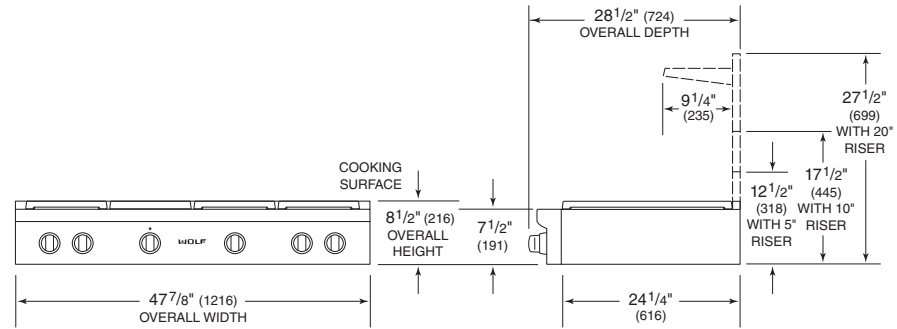

Unit dimensions may vary to ±1/8" (3).

MODEL OPTIONS

48" (1219) Sealed Burner Rangetops

Six Surface Burners

Charbroiler	SRT486C
Griddle	SRT486G

Four Surface Burners

Charbroiler and Griddle	SRT484CG
Double Griddle	SRT484DG
French Top	SRT484F

Natural gas models listed; for LP gas add (-LP) to the model number.

IMPORTANT NOTE: A minimum 10" (254) riser is required for charbroiler (C) or griddle (G) models installed against a combustible surface.

INSTALLATION SPECIFICATIONS

48" (1219) Sealed Burner Rangetop

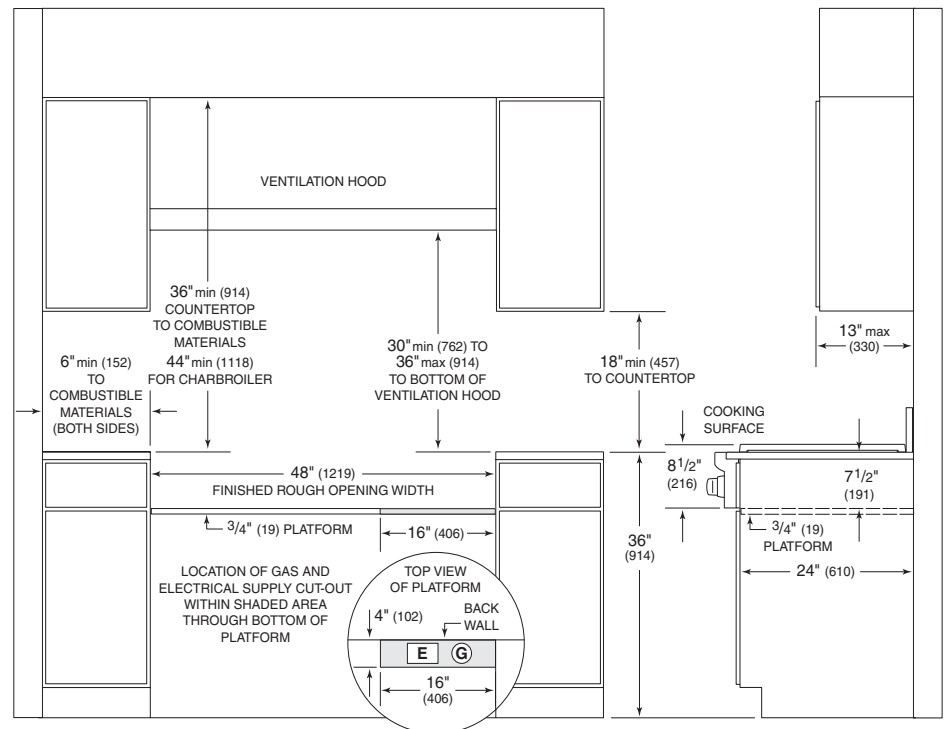

ISLAND INSTALLATIONS: 12" (305) MINIMUM CLEARANCE FROM BACK OF RANGETOP TO COMBUSTIBLE REAR WALL ABOVE COUNTERTOP- 0" (0) TO NON-COMBUSTIBLE MATERIALS

Dimensions in parentheses are in millimeters unless otherwise specified.

Refer to installation instructions shipped with each Wolf product for detailed specifications.



WOLF GAS RANGES

If it looks as if it could be in a restaurant kitchen, well, that's natural. That's precisely where Wolf has spent the past seven decades, perfecting the form, function and sheer durability of our stainless steel gas ranges.

Wolf gas ranges come in 30" (762), 36" (914), 48" (1219) and 60" (1524) widths, and combined with the top configuration options, the different configurations you can choose from are numerous. Model numbers indicate the top configurations: (C) charbroiler, (G) griddle, (DG) double griddle and (F) French Top.

Advanced standard features such as an infrared oven broiler, convection baking and dual burners along with the Wolf exclusive infrared charbroiler, infrared griddle and French Top are all yours for the asking. The freedom to customize your gas range will make you and your client look great.

All Wolf gas ranges come in the classic stainless steel finish and are shipped with the distinctive red control knobs. Contact your Wolf dealer for optional black knobs available at no cost.

TOP CONFIGURATIONS
Gas Ranges

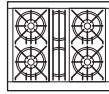

R304

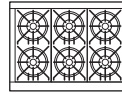

R366

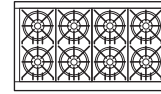

R488

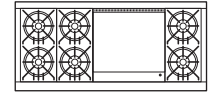

R606DG

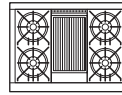

R364C

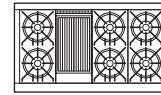

R486C

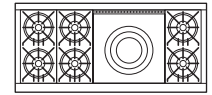

R606F

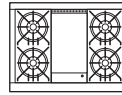

R364G

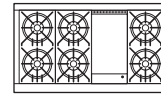

R486G

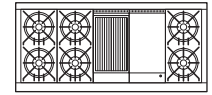

R606CG

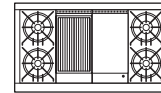

R484CG

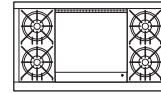

R484DG

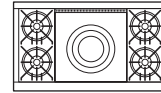

R484F



This appliance is certified by Star-K to meet strict religious regulations in conjunction with specific instructions found on www.star-k.org.



FEATURES

- Natural** or LP gas models
- Fits** standard 24" (610) deep cabinets with zero clearance for easy installation
- Optional** infrared charbroiler, infrared griddle and French Top configurations
- Classic** stainless steel exterior finish
- Dual** brass burners with automatic reignition at all settings, 500 Btu/hr (.1 kW) simmer to 16,000 Btu/hr (4.7 kW) high
- Porcelain-coated** cast iron top grates
- Large** red control knobs with four position settings and chrome bezels—optional black knobs available

- Large-capacity** convection oven(s) with infrared broiler, porcelain interior, three adjustable racks, lights and door window
- 18"** (457) oven with porcelain interior, two adjustable racks, lights and door window on 48" (1219) range
- Spring/Damper** door system on oven door(s)
- Stainless** steel drip tray on ball bearing slides
- Adjustable** 3" (76) stainless steel legs in front and rear casters
- Full** side panels and skirt
- High** altitude conversion kit available
- CSA** certified for US and Canada

WOLF WARRANTY

Wolf products are covered by a two and five year residential warranty (exclusions apply). See warranty details at the end of this guide.

GAS RANGE FEATURES

Model R484CG shown with 5" (127) riser

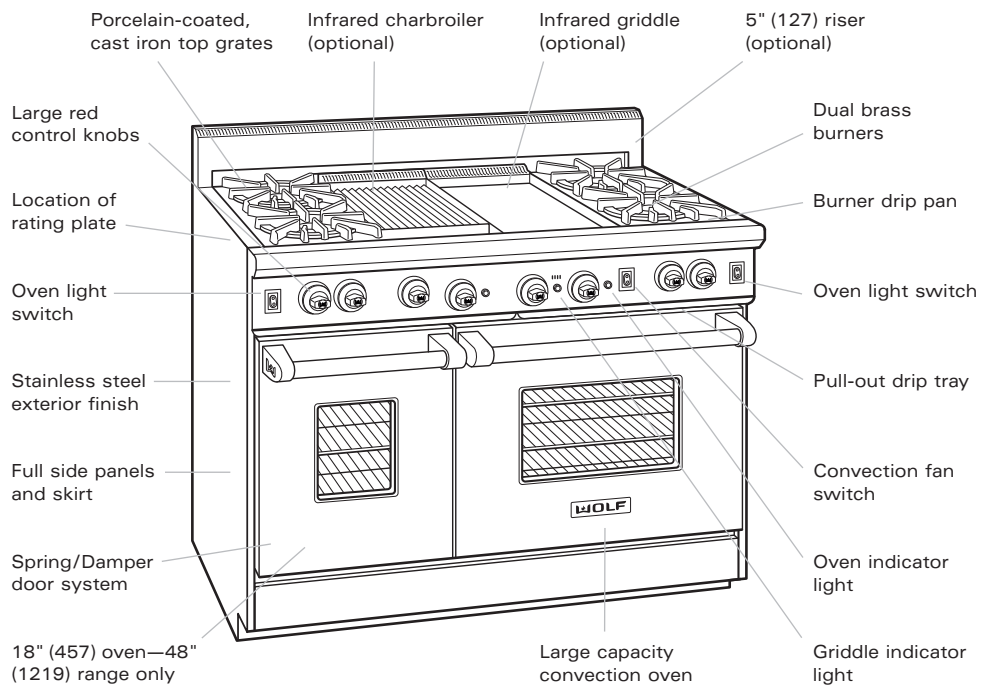

ACCESSORIES

Gas Ranges

- 5" (127) and 10" (254) classic stainless steel risers**
- 20" (508) classic stainless steel riser with shelf**
- Classic stainless steel island trim**
- Black control knobs—available at no cost**
- Porcelain-coated, cast iron wok grate**
- Porcelain-coated, cast iron two-burner S-grate**
- Hardwood cutting board—griddle models only**
- Additional oven racks**
- High altitude conversion kit**

Accessories are available through your Wolf dealer. To obtain local dealer information, visit the Showroom Locator section of our website, wolfappliance.com.

Dimensions in parentheses are in millimeters unless otherwise specified.



PLANNING INFORMATION

Wolf gas ranges come in 30" (762), 36" (914), 48" (1219) and 60" (1524) widths. Specifications on the following pages provide overall dimensions, finished rough opening dimensions and installation specifics for each size of gas range. We have minimized the information contained in the illustrations, concentrating on the critical information you need to plan your installation.

IMPORTANT NOTE: Caution must be used in planning the proper installation of the Wolf gas range to avoid fires or damage to adjacent cabinetry or kitchen equipment. Please follow the minimum clearances established in the finished rough opening dimensions. Refer to specifications on the following pages for your model.

It is recommended that you use a Wolf Pro ventilation hood or hood liner with the Wolf gas range. Refer to pages 102–114 for Pro ventilation specifications.

ELECTRICAL | GAS REQUIREMENTS

The Wolf gas range requires a 110/120 V AC, 50/60 Hz electrical supply to operate the electronic ignition system. The power supply cord is equipped with a 3-prong, grounded plug for protection against shock hazard. The service should have its own 15 amp circuit breaker.

IMPORTANT NOTE: A ground fault circuit interrupter (GFCI) is not recommended and may cause interruption of operation.

Locate electrical and gas supply within the shaded area shown in the Installation Specifications illustration for your model.

Wolf gas ranges are designed to operate on natural gas at 5" (12.5 mb) WC (water column) pressure or LP (propane) gas at 10" (25 mb) WC pressure. The minimum line pressure for natural gas is 7" (17.5 mb) WC and 11" (27.4 mb) WC for LP gas. The maximum gas supply pressure to the regulator should never exceed 14" (34.9 mb) WC, .5 psi (3.5 kPa).

Wolf recommends the use of a 1/2" (13) I.D. commercial-type flex hose; this is the minimum size that may be used. All plumbing to the flex hose **must** be 3/4" (19) minimum I.D. pipe.

IMPORTANT NOTE: A separate external gas shut-off valve must be located near the range in an accessible location.

You must follow all National Electrical Code and gas regulations. In addition, be aware of local codes and ordinances when installing your services.

HIGH ALTITUDE

The Wolf gas range functions up to 6,000' (1828 m) in altitude without any adjustment. If the installation is above 6,000' (1828 m), contact your Wolf dealer.

BURNER RATING

Gas Ranges

Surface Burners	16,000 Btu/hr (4.7 kW) with 500 Btu/hr (.1 kW) delivered at simmer
Infrared Charbroiler	16,000 Btu/hr (4.7 kW)
Infrared Griddle	18,000 Btu/hr (5.3 kW)
Infrared Double Griddle	(2) 18,000 Btu/hr (5.3 kW)
French Top	15,000 Btu/hr (4.4 kW)
Oven Burner (Bake)	30,000 Btu/hr (8.8 kW)
Infrared Oven Broiler	18,000 Btu/hr (5.3 kW)

Refer to the specific model requirements for risers in non-island installations.



WOLF GAS RANGES

OVERALL DIMENSIONS

30" (762) Gas Range

SPECIFICATIONS

30" (762) Gas Range

Overall Width	30" (762)
Overall Height (to cooking surface)	37" (940)
Overall Depth	28³/₈" (721)
Overall Oven Interior Capacity	4.4 cu ft (125 L)
Overall Interior Dim (W x H x D)	24" x 18⁵/₈" x 17" (610 x 473 x 432)
Usable Interior Dim (W x H x D)	24" x 16¹/₂" x 17" (610 x 419 x 432)
Opening Width	30¹/₄" (768)
Electrical Supply	110/120 V AC, 50/60 Hz 15 amp circuit
Power Cord	6' (1.8 m) 3-prong
Shipping Weight	325 lbs (147 kg)

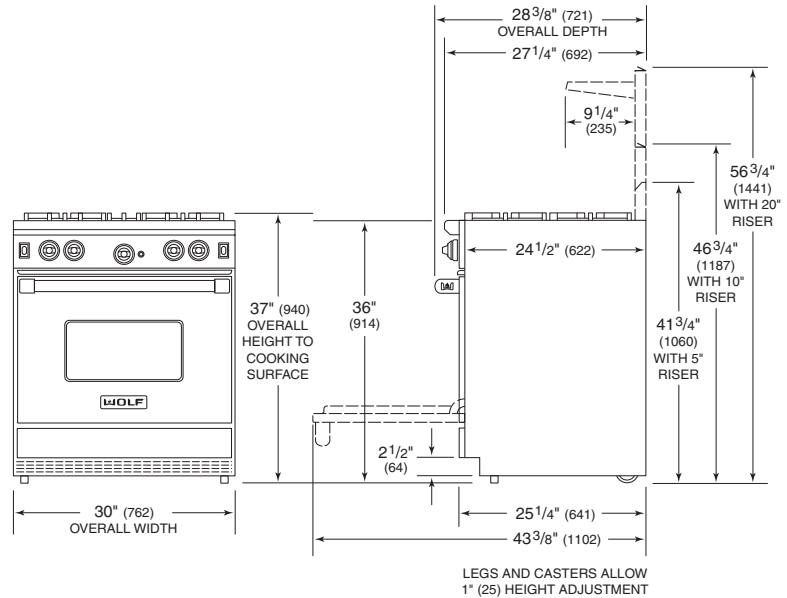

Unit dimensions may vary to $\pm 1/8"$ (3).

MODEL OPTIONS

30" (762) Gas Range

Four Surface Burners R304

Natural gas model listed;
for LP gas add (-LP) to the
model number.

IMPORTANT NOTE: A
minimum 5" (127) riser is
required when installing a
30" (762) gas range against
a combustible surface.

INSTALLATION SPECIFICATIONS

30" (762) Gas Range

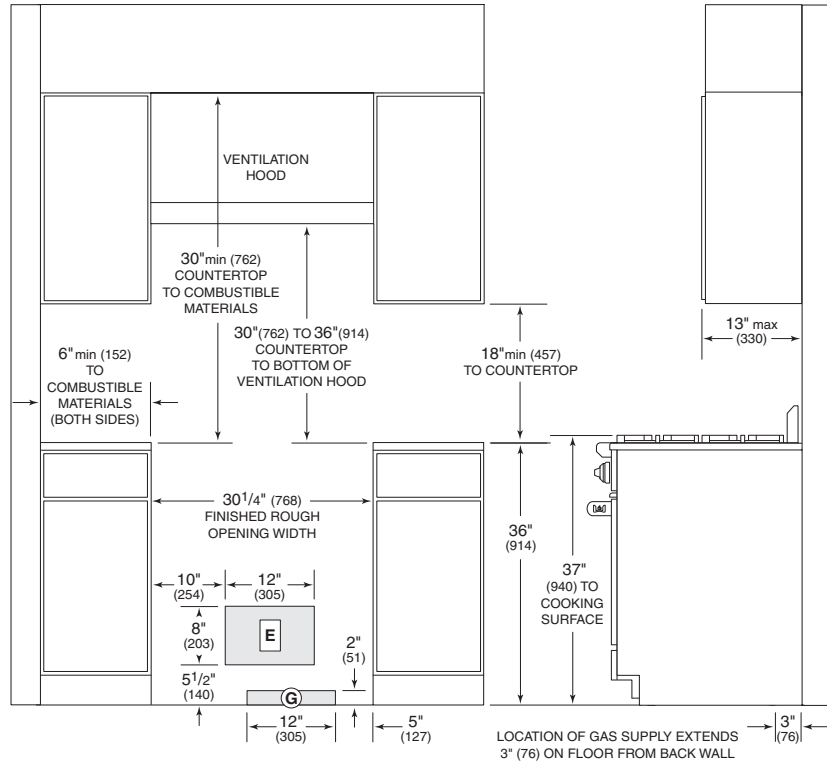

ISLAND INSTALLATIONS: 12" (305) MINIMUM CLEARANCE FROM BACK
OF RANGE TO COMBUSTIBLE REAR WALL ABOVE COUNTERTOP -
0" (0) TO NON-COMBUSTIBLE MATERIALS

Dimensions in
parentheses are in
millimeters unless
otherwise specified.



OVERALL DIMENSIONS

36" (914) Gas Range

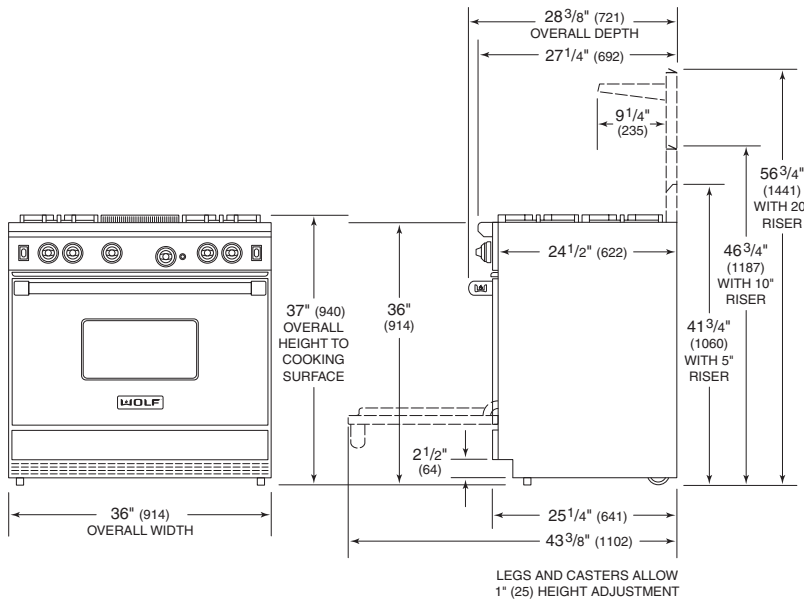

SPECIFICATIONS

36" (914) Gas Range

Overall Width	36" (914)
Overall Height (to cooking surface)	37" (940)
Overall Depth	28³/₈" (721)
Overall Oven Interior Capacity	5.5 cu ft (156 L)
Overall Interior Dim (W x H x D)	30" x 18⁵/₈" x 17" (762 x 473 x 432)
Usable Interior Dim (W x H x D)	30" x 16¹/₂" x 17" (762 x 419 x 432)
Opening Width	36¹/₄" (921)
Electrical Supply	110/120 V AC, 50/60 Hz 15 amp circuit
Power Cord	6' (1.8 m) 3-prong
Shipping Weight	445-470 lbs (202-213 kg)

Unit dimensions may vary to ±1/8" (3).

INSTALLATION SPECIFICATIONS

36" (914) Gas Range

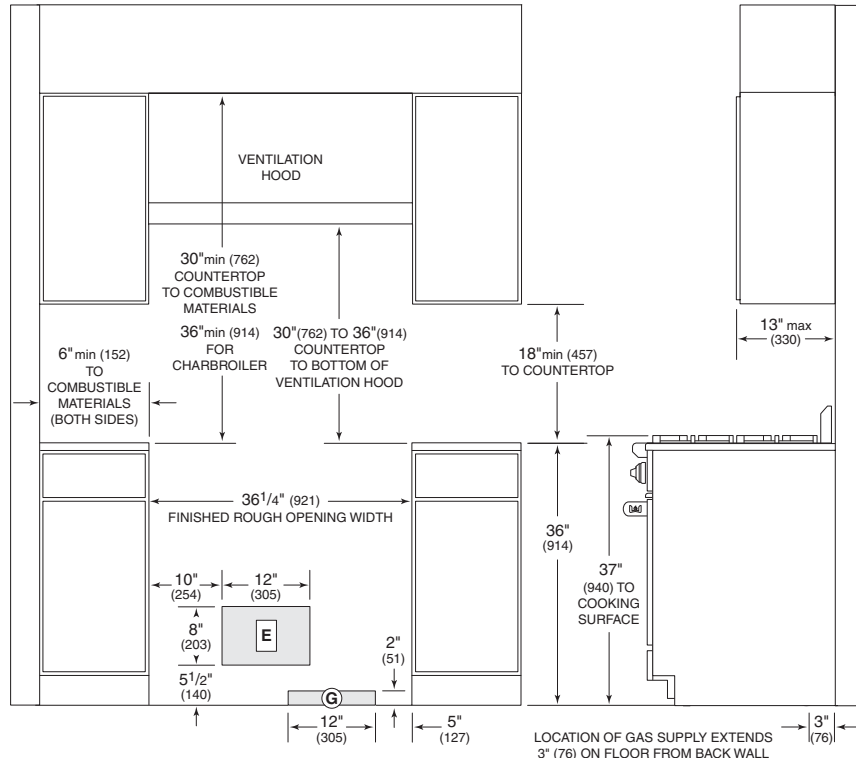

ISLAND INSTALLATIONS: 12" (305) MINIMUM CLEARANCE FROM BACK OF RANGE TO COMBUSTIBLE REAR WALL ABOVE COUNTERTOP - 0" (0) TO NON-COMBUSTIBLE MATERIALS

MODEL OPTIONS

36" (914) Gas Range

Six Surface Burners	R366
Four Surface Burners	
Charbroiler	R364C
Griddle	R364G

Natural gas models listed; for LP gas add (-LP) to the model number.

IMPORTANT NOTE: A minimum 5" (127) riser is required when installing a gas range against a combustible surface. A minimum 10" (254) riser is required when installing a gas range with a charbroiler or griddle against a combustible surface.

Refer to installation instructions shipped with each Wolf product for detailed specifications.



WOLF GAS RANGES

OVERALL DIMENSIONS

48" (1219) Gas Range

SPECIFICATIONS

48" (1219) Gas Range

Overall Width	48" (1219)
Overall Height (to cooking surface)	37" (940)
Overall Depth	28³/₈" (721)
Large Oven—	
Overall Interior Cap	4.4 cu ft (125 L)
Overall Interior Dim (W x H x D)	24" x 18⁵/₈" x 17" (610 x 473 x 432)
Usable Interior Dim (W x H x D)	24" x 16¹/₂" x 17" (610 x 419 x 432)
Small Oven—	
Overall Interior Cap	2.5 cu ft (71 L)
Overall Interior Dim (W x H x D)	13¹/₂" x 18⁵/₈" x 17" (343 x 473 x 432)
Usable Interior Dim (W x H x D)	13¹/₂" x 16¹/₂" x 17" (343 x 419 x 432)
Opening Width	48¹/₄" (1226)
Electrical Supply	110/120 V AC, 50/60 Hz 15 amp circuit
Power Cord	6' (1.8 m) 3-prong
Shipping Weight	650–750 lbs (295–340 kg)

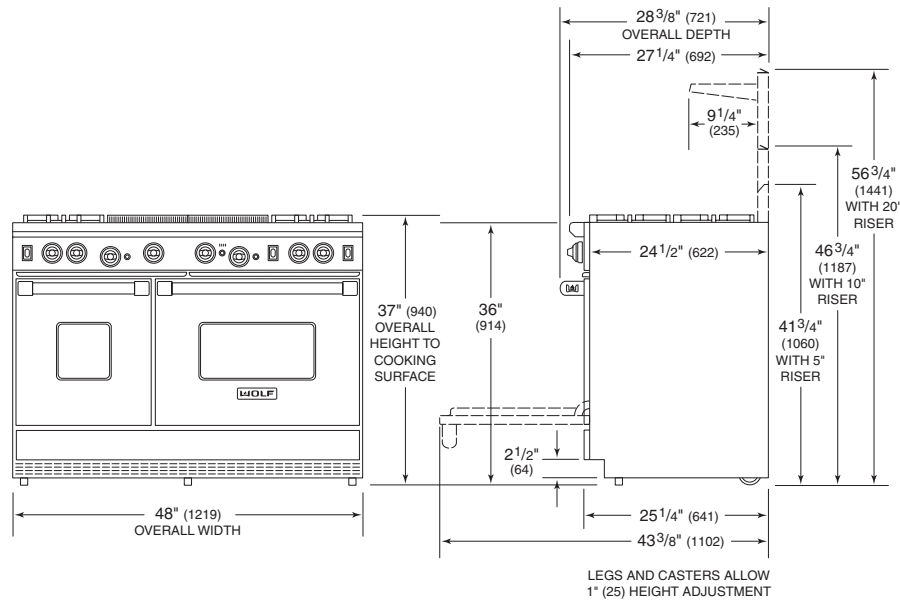

Unit dimensions may vary to ±1/8" (3).

INSTALLATION SPECIFICATIONS

48" (1219) Gas Range

MODEL OPTIONS

48" (1219) Gas Range

Eight Surface Burners	R488
Six Surface Burners	
Charbroiler	R486C
Griddle	R486G
Four Surface Burners	
Charbroiler and Griddle	R484CG
Double Griddle	R484DG
French Top	R484F

Natural gas models listed; for LP gas add (-LP) to the model number.

IMPORTANT NOTE: A minimum 5" (127) riser is required when installing a gas range against a combustible surface. A minimum 10" (254) riser is required when installing a gas range with a charbroiler or griddle against a combustible surface.

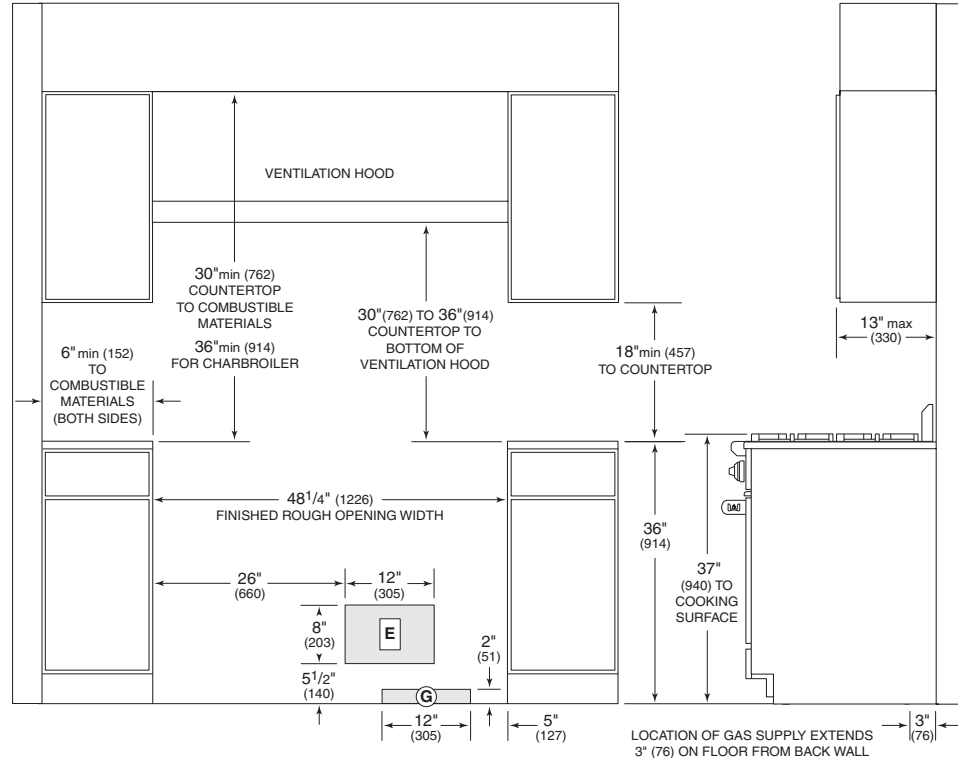

ISLAND INSTALLATIONS: 12" (305) MINIMUM CLEARANCE FROM BACK OF RANGE TO COMBUSTIBLE REAR WALL ABOVE COUNTERTOP – 0" (0) TO NON-COMBUSTIBLE MATERIALS



OVERALL DIMENSIONS
60" (1524) Gas Range

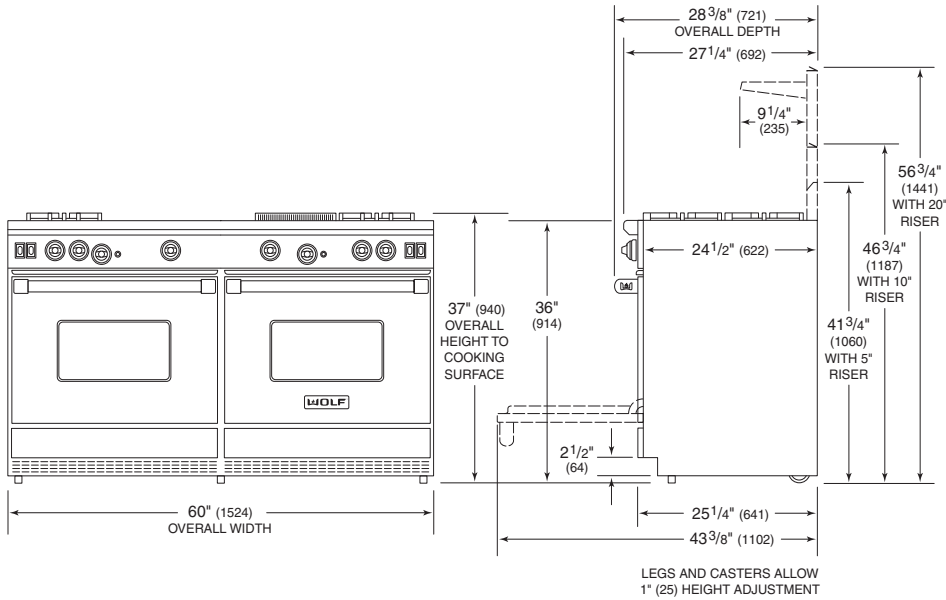

SPECIFICATIONS
60" (1524) Gas Range

Overall Width	60" (1524)
Overall Height (to cooking surface)	37" (940)
Overall Depth	28 3/8" (721)
Overall Oven Interior Capacity (per oven)	4.4 cu ft (125 L)
Overall Interior Dim (W x H x D)	24" x 18 5/8" x 17" (610 x 473 x 432) each
Usable Interior Dim (W x H x D)	24" x 16 1/2" x 17" (610 x 419 x 432) each
Opening Width	60 1/4" (1530)
Electrical Supply	110/120 V AC, 50/60 Hz 15 amp circuit
Power Cord	6' (1.8 m) 3-prong
Shipping Weight	875-950 lbs (397-431 kg)

Unit dimensions may vary to ±1/8" (3).

INSTALLATION SPECIFICATIONS
60" (1524) Gas Range

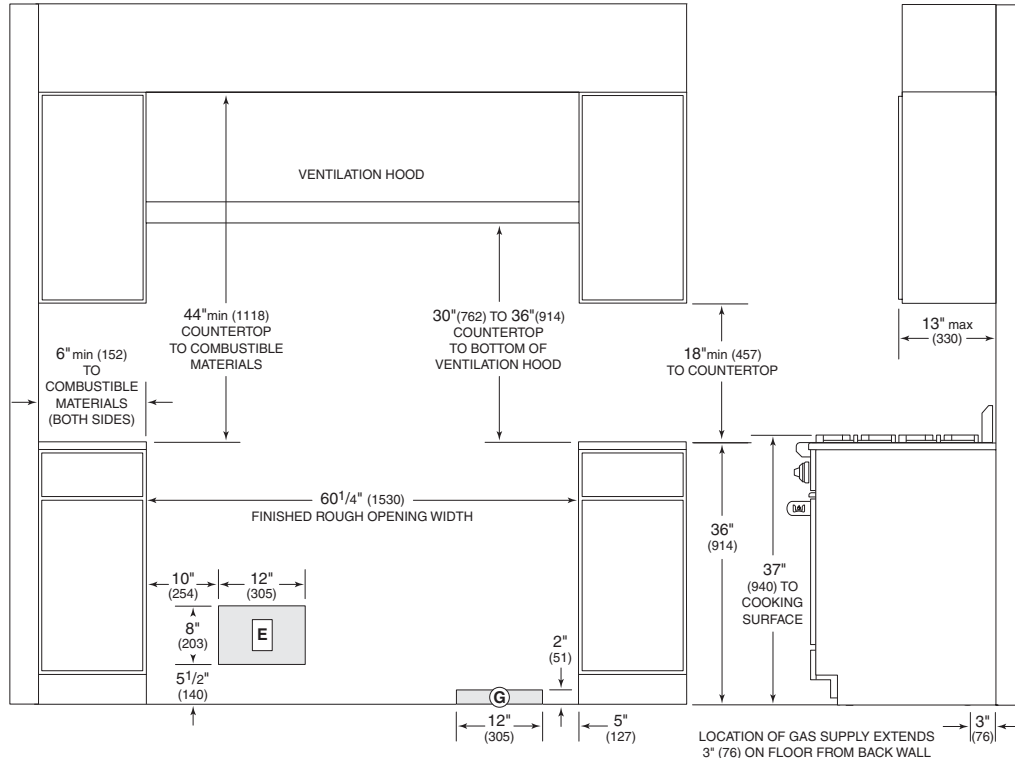

ISLAND INSTALLATIONS: 12" (305) MINIMUM CLEARANCE FROM BACK OF RANGE TO COMBUSTIBLE REAR WALL ABOVE COUNTERTOP - 0" (0) TO NON-COMBUSTIBLE MATERIALS

MODEL OPTIONS
60" (1524) Gas Range

- Six Surface Burners**
- Double Griddle **R606DG**
 - French Top **R606F**
 - Charbroiler and Griddle **R606CG**

Natural gas models listed; for LP gas add (-LP) to the model number.

IMPORTANT NOTE: A minimum 5" (127) riser is required when installing a gas range against a combustibles surface. A minimum 10" (254) riser is required when installing a gas range with a charbroiler or griddle against a combustibles surface.

Refer to installation instructions shipped with each Wolf product for detailed specifications.



WOLF GAS RANGETOPS

If you want to offer a more professional look to your client’s kitchen and still use a cooktop, look to the rangetops from Wolf. They offer you that commercial look but give you flexibility to use the ovens in other locations in the kitchen. In fact, the Wolf framed ovens would be a beautiful complement to these cooking instruments.

Wolf gas rangetops come in 36" (914) and 48" (1219) widths and are available in natural or LP gas, with your choice of several top configurations. Model numbers indicate the top configurations: (C) charbroiler, (G) griddle, (DG) double griddle and (F) French Top.

Choose from two, four, six or eight dual burners or consider the Wolf exclusive infrared charbroiler, infrared griddle or French Top for the ultimate in restaurant cooking in the home.

The dual burners can produce 16,000 Btu/hr (4.7 kW) for professional cooking heat or as little as 500 Btu/hr (.1 kW) for those delicate sauces.

All Wolf gas rangetops come in the classic stainless steel finish and are shipped with the distinctive red control knobs. Contact your Wolf dealer for optional black knobs available at no cost.

WOLF WARRANTY

Wolf products are covered by a two and five year residential warranty (exclusions apply). See warranty details at the end of this guide.

TOP CONFIGURATIONS

Gas Rangetops

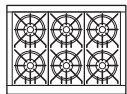

RT366

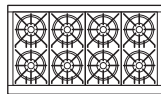

RT488

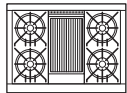

RT364C

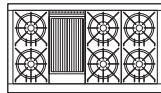

RT486C

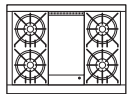

RT364G

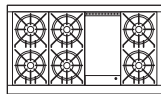

RT486G

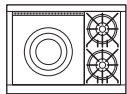

RT362F

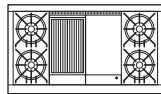

RT484CG

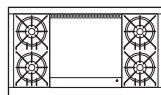

RT484DG

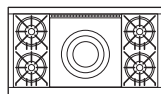

RT484F

GAS RANGETOP FEATURES

Model RT484CG shown with island trim

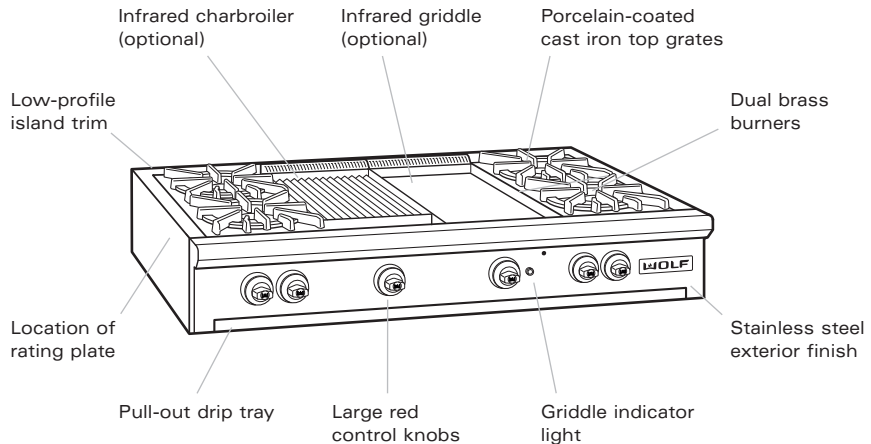

 This appliance is certified by Star-K to meet strict religious regulations in conjunction with specific instructions found on www.star-k.org.

ACCESSORIES

Gas Rangetops

- 10¹/₂" (267) classic stainless steel riser
- Classic stainless steel island trim
- Black control knobs—available at no cost
- Porcelain-coated, cast iron wok grate
- Porcelain-coated, cast iron two-burner S-grate
- Hardwood cutting board—griddle models only
- High altitude conversion kit

Accessories are available through your Wolf dealer. To obtain local dealer information, visit the Showroom Locator section of our website, wolfappliance.com.



FEATURES

Natural or LP gas models

Fits standard 24" (610) deep cabinets with zero clearance for easy installation

Optional infrared charbroiler, infrared griddle and French Top configurations

Classic stainless steel exterior finish

Dual brass burners with automatic reignition at all settings, 500 Btu/hr (.1 kW) simmer to 16,000 Btu/hr (4.7 kW) high

Porcelain-coated cast iron top grates

Large red control knobs with four position settings and chrome bezels—optional black knobs available

Stainless steel drip tray on ball bearing slides

High altitude conversion kit available

CSA certified for US and Canada

PLANNING INFORMATION

Wolf gas rangetops come in 36" (914) and 48" (1219) widths. Specifications on the following pages provide overall dimensions, finished rough opening dimensions and installation specifics for each size of gas rangetop. We have minimized the information contained in the illustrations, concentrating on the critical information you need to plan your installation.

IMPORTANT NOTE: Caution must be used in planning the proper installation of the Wolf gas rangetop to avoid fires or damage to adjacent cabinetry or kitchen equipment. Follow the minimum clearances established in the finished rough opening dimensions. Refer to specifications on the following pages for your model.

It is recommended that you use a Wolf Pro ventilation hood or hood liner with the Wolf gas rangetop. Refer to pages 102-114 for Pro ventilation specifications.

ELECTRICAL | GAS REQUIREMENTS

Specifications on the following pages provide electrical and gas requirements for each size of gas rangetop.

The Wolf gas rangetop requires a 110/120 V AC, 50/60 Hz electrical supply to operate the electronic ignition system. The power supply cord is equipped with a 3-prong, grounded plug for protection against shock hazard. The service should have its own 15 amp circuit breaker.

IMPORTANT NOTE: A ground fault circuit interrupter (GFCI) is not recommended and may cause interruption of operation.

Wolf gas rangetops are designed to operate on natural gas at 5" (12.5 mb) WC (water column) pressure or LP (propane) gas at 10" (25 mb) WC pressure. The minimum line pressure for natural gas is 7" (17.5 mb) WC and 11" (27.4 mb) WC for LP gas. The maximum gas supply pressure to the regulator should never exceed 14" (34.9 mb) WC, .5 psi (3.5 kPa).

Wolf recommends the use of a 1/2" (13) I.D. commercial-type flex hose; this is the minimum size that may be used. All plumbing to the flex hose **must** be 3/4" (19) minimum I.D. pipe.

IMPORTANT NOTE: A separate external gas shut-off valve must be located near the range in an accessible location.

The platform for the rangetop must be 3/4" (19) thick and include a cut-out at the right rear for gas supply and electrical connections.

Locate electrical and gas supply within the shaded area shown in the Installation Specifications illustration for your model.

You must follow all National Electrical Code and gas regulations. In addition, be aware of local codes and ordinances when installing your services.

HIGH ALTITUDE

The Wolf gas rangetop functions up to 6,000' (1828 m) in altitude without any adjustment. If the installation is above 6,000' (1828 m), contact your Wolf dealer.

BURNER RATING

Gas Rangetops

Surface Burners	16,000 Btu/hr (4.7 kW) with 500 Btu/hr (.1 kW) delivered at simmer
Infrared Charbroiler	16,000 Btu/hr (4.7 kW)
Infrared Griddle	18,000 Btu/hr (5.3 kW)
Infrared Double Griddle	(2) 18,000 Btu/hr (5.3 kW)
French Top	15,000 Btu/hr (4.4 kW)

Refer to the specific model requirements for risers in non-island installations.



WOLF GAS RANGETOPS

OVERALL DIMENSIONS 36" (914) Gas Rangetop

SPECIFICATIONS

36" (914) Gas Rangetop

Overall Width	36" (914)
Overall Height (to cooking surface)	10 1/2" (267)
Overall Depth	27 1/4" (692)
Opening Width	36 1/4" (921)
Opening Height (platform to countertop)	9 1/2" (241)
Electrical Supply	110/120 V AC, 50/60 Hz 15 amp circuit
Power Cord	6' (1.8 m) 3-prong
Shipping Weight	190-220 lbs (86-100 kg)

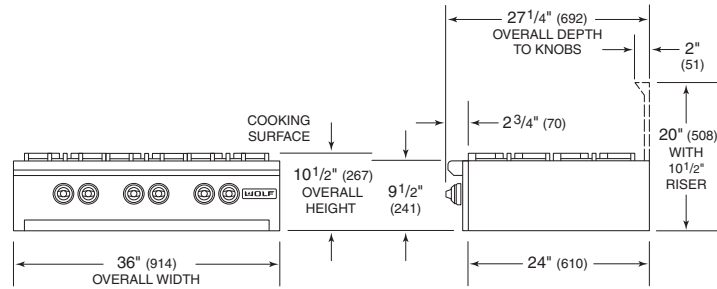

Unit dimensions may vary to ±1/8" (3).

MODEL OPTIONS

36" (914) Gas Rangetop

Six Surface Burners	RT366
Four Surface Burners	
Charbroiler	RT364C
Griddle	RT364G
Two Surface Burners	
French Top	RT362F

Natural gas models listed; for LP gas add (-LP) to the model number.

IMPORTANT NOTE: In non-island applications, a riser is required when installing a 36" (914) gas rangetop against a combustible surface.

INSTALLATION SPECIFICATIONS

36" (914) Gas Rangetop

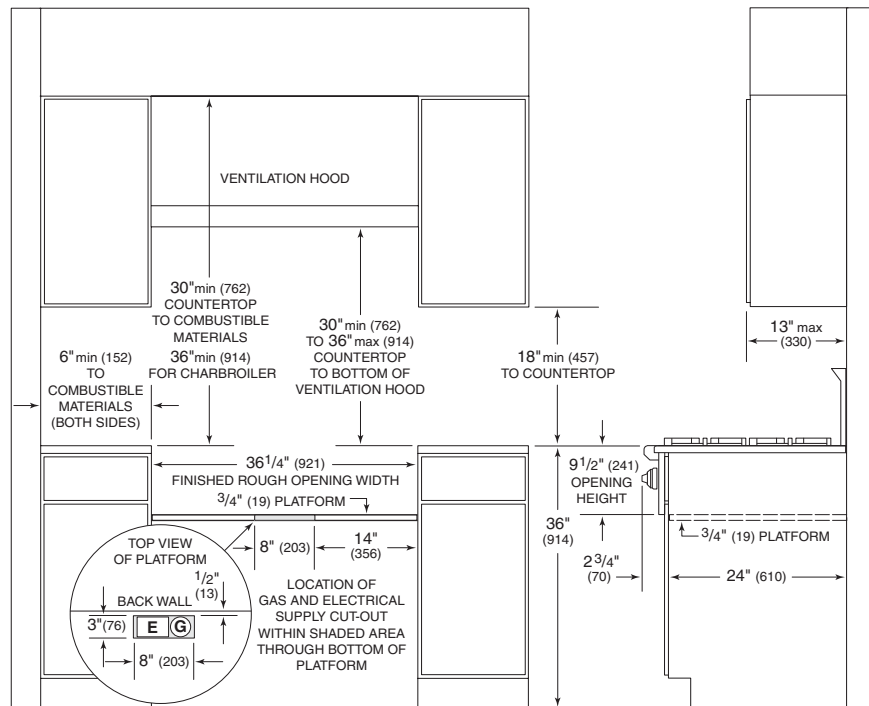

ISLAND INSTALLATIONS: 12" (305) MINIMUM CLEARANCE FROM BACK OF RANGETOP TO COMBUSTIBLE REAR WALL ABOVE COUNTERTOP- 0" (0) TO NON-COMBUSTIBLE MATERIALS

Dimensions in parentheses are in millimeters unless otherwise specified.



WOLF OUTDOOR GAS GRILLS

To our way of thinking, cooking is every bit as much a performing art as music or theater. So here is our logic. When the symphony or the Shakespeare troupe moves outdoors for the festival season, the venue is more casual than usual, but the performance loses nothing in terms of artistry. Why can't cooking be the same way? With Wolf it is.

Like their kitchen counterparts, Wolf outdoor gas grills are precision instruments.

Constructed of heavy-duty stainless steel, both the 36" (914) and 48" (1219) models are available built-in or as a freestanding grill on a cart. Model numbers followed by (BI) indicate a built-in unit, while (C) indicates that the grill is on a freestanding cart. Features include a 115-volt rotisserie, an infrared rear burner for precise, consistent grilling, and optional side burners.

WOLF WARRANTY

Two and five year residential warranty, along with a limited lifetime warranty on the grill body and hood (exclusions apply). See warranty details at the end of this guide.

FEATURES

Natural or LP gas units

Built-in (BI) or freestanding cart (C) models

Heavy-duty 18-gauge stainless steel construction with classic stainless steel exterior finish

Push-button, battery-powered ignition

Individually controlled 10,000 Btu/hr (2.9 kW) stainless steel grill burners and 9,000 Btu/hr (2.6 kW) infrared rotisserie burner—8,000 Btu/hr (2.3 kW) for Model BBQ242

Optional 16,000 Btu/hr (4.7 kW) step-up cast iron side burners

Cast iron porcelain-coated grill grates

Redesigned burner radiant plates

115-volt rotisserie motor and infrared rear rotisserie burner

Two-piece stainless steel hood and handle

LP gas models include gas regulator, hose and 5-gallon (19 L) tank

Heavy-duty locking swivel casters on cart models

Scraper and protective canvas cover included

TOP CONFIGURATIONS

Outdoor Gas Grills

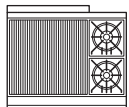

BBQ242BI

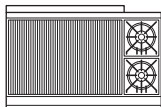

BBQ362BI

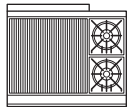

BBQ242C

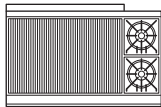

BBQ362C

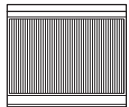

BBQ36BI

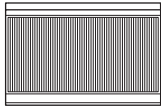

BBQ48BI

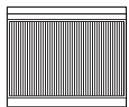

BBQ36C

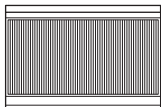

BBQ48C

OUTDOOR GAS GRILL FEATURES

Model BBQ362C shown

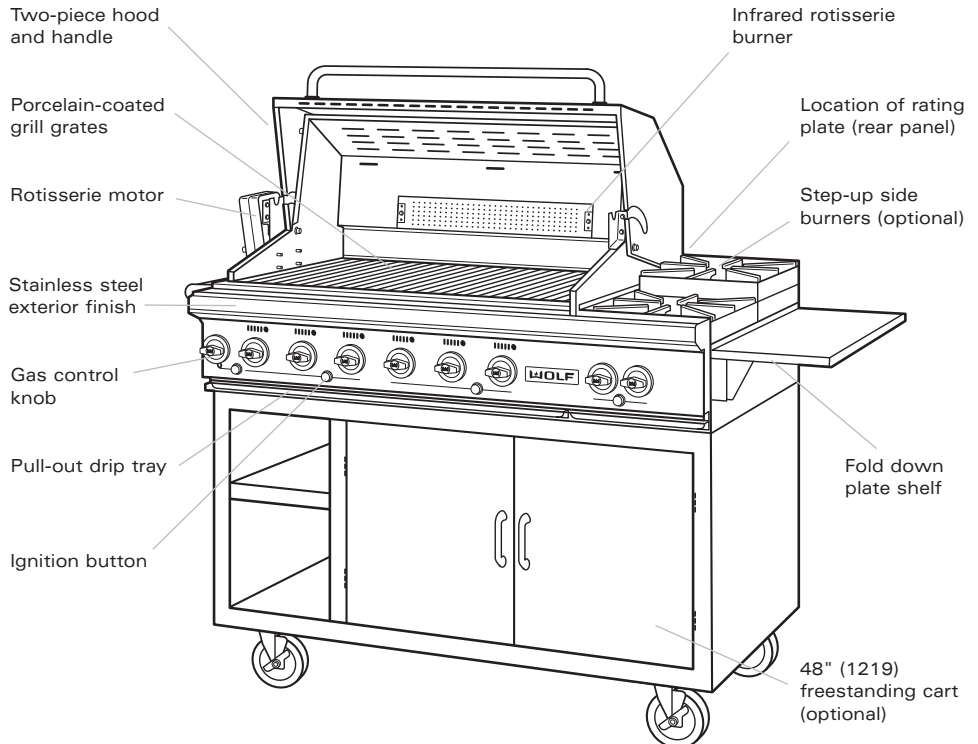



PLANNING INFORMATION

It goes without saying that the outdoor gas grill mounted on the freestanding cart takes very little planning from a design perspective. However, there are provisions you need to take into account when planning for a built-in application.

When choosing a permanent built-in location for your Wolf outdoor gas grill, keep the gas lines as short as possible. Allow for an adequate supply of fresh air for proper combustion and ventilation. The grill should not be exposed to the wind, but never locate the grill indoors.

The Wolf outdoor gas grill is designed for easy placement into a built-in enclosure. For a combustible enclosure, use the Wolf-approved insulated liner and maintain minimum clearances to combustible surfaces. Built-in installations require a deck to support the grill. The supporting deck should be level and strong enough to support 400 lbs (181 kg).

Wolf outdoor gas grills come in 36" (914) and 48" (1219) widths. Specifications on the following pages provide overall dimensions, finished rough opening dimensions and installation specifics for each size of grill. We have minimized the information contained in the illustrations, concentrating on the critical information you need to plan your installation.

IMPORTANT NOTE: The Wolf outdoor gas grill must be specified natural or LP gas at the time of order. The gas type cannot be converted.

ELECTRICAL | GAS REQUIREMENTS

The Wolf outdoor gas grill requires a 110/120 V electrical supply to operate the rotisserie motor. The 9' (2.7 m) power supply cord provided with the grill is equipped with a 3-prong, grounded plug for protection against shock hazard. The service should have its own 15 amp circuit breaker.

IMPORTANT NOTE: A ground fault circuit interrupter (GFCI) is not recommended and may cause interruption of operation.

Locate electrical and gas supply within the shaded area shown in the Installation Specifications illustration for your built-in model.

Wolf outdoor gas grills are designed to operate on natural gas at 5" (12.5 mb) WC (water column) pressure or LP (propane) gas at 10" (25 mb) WC pressure. The minimum line pressure for natural gas is 7" (17.5 mb) WC and 11" (27.4 mb) WC for LP gas. The maximum gas supply pressure to the regulator should never exceed 14" (34.9 mb) WC, .5 psi (3.5 kPa).

Wolf recommends the use of a 1/2" (13) I.D. commercial-type flex hose; this is the minimum size that may be used. All plumbing to the flex hose **must** be 3/4" (19) minimum I.D. pipe.

IMPORTANT NOTE: A separate external gas shut-off valve must be located near the range in an accessible location.

You must follow all National Electrical Code and gas regulations. In addition, be aware of local codes and ordinances when installing your services.

ACCESSORIES

Optional accessories are available through your Wolf dealer. To obtain local dealer information, visit the Showroom Locator section of our website, wolfappliance.com.

ACCESSORIES

Outdoor Gas Grills

Black control knobs—available at no cost

Insulated liner for built-in applications

Accessories are available through your Wolf dealer. To obtain local dealer information, visit the Showroom Locator section of our website, wolfappliance.com.

BURNER RATING

Outdoor Gas Grills

Grill Burners (per burner)	10,000 Btu/hr (2.9 kW)
Side Burners (per burner)	(2) 16,000 Btu/hr (4.7 kW)
Infrared Burner	8,000 Btu/hr* (2.3 kW)
Infrared Burner	9,000 Btu/hr (2.6 kW)

**Models BBQ242BI and BBQ242C only.*



WOLF OUTDOOR GRILLS

OVERALL DIMENSIONS

36" (914) Outdoor Grills

Model BBQ36C shown

SPECIFICATIONS

36" (914) Outdoor Grills

Overall Width	36" (914)
Overall Height	
(BI) Models	26" (660)
(C) Models	52³/₄" (1340)
Overall Depth	30" (762)

Combustible Enclosure

Opening Width	38¹/₄" (972)
Opening Depth	27³/₄" (705)

Non-Combustible Enclosure

Opening Width	36¹/₄" (921)
Opening Depth	26³/₄" (679)
Electrical Supply	110/120 V AC, 60 Hz
	15 amp circuit

Power Cord **9' (2.7 m) 3-prong**

Shipping Weight **340-460 lbs (154-209 kg)**

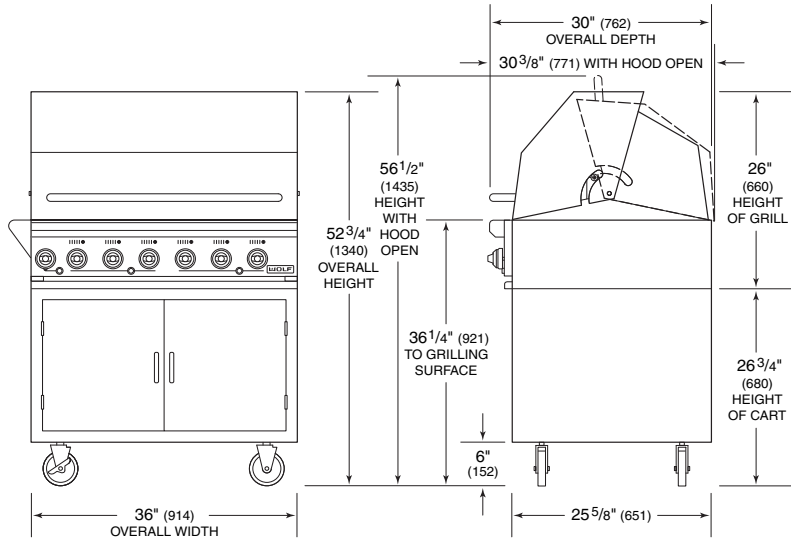

Unit dimensions may vary to ±1/8" (3).

MODEL OPTIONS

36" (914) Outdoor Grills

Built-In Models

with Side Burners **BBQ242BI**

w/o Side Burners **BBQ36BI**

Freestanding Cart Models

with Side Burners **BBQ242C**

w/o Side Burners **BBQ36C**

Natural gas models listed;
for LP gas add (-LP) to the
model number.

INSTALLATION SPECIFICATIONS

36" (914) Outdoor Grills - Built-In (BI) Models

Combustible Enclosure

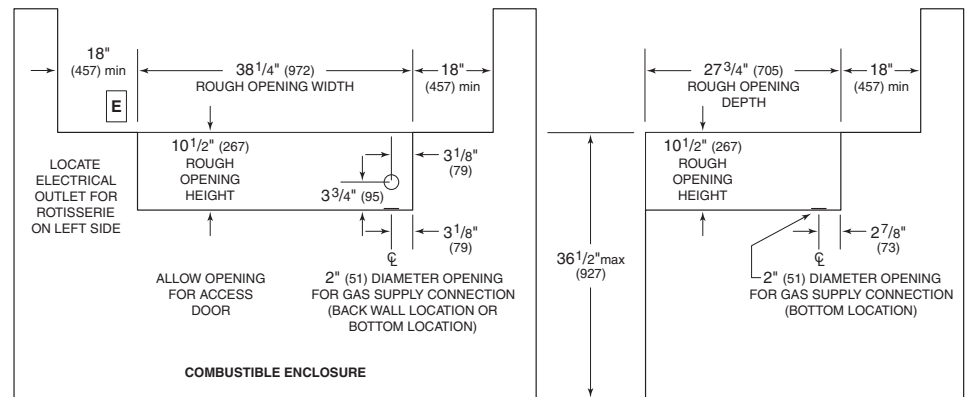

NOTE: Dimensions include insulated liner.

Non-Combustible Enclosure

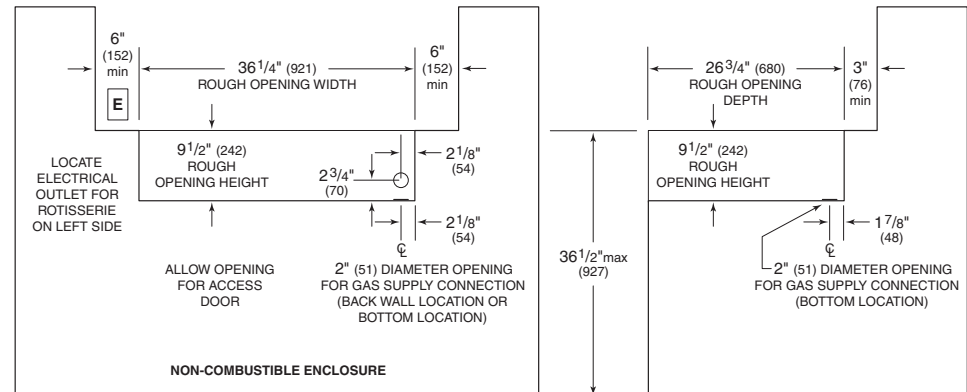

Dimensions in
parentheses are in
millimeters unless
otherwise specified.



OVERALL DIMENSIONS

48" (1219) Outdoor Grills

Model BBQ362C shown

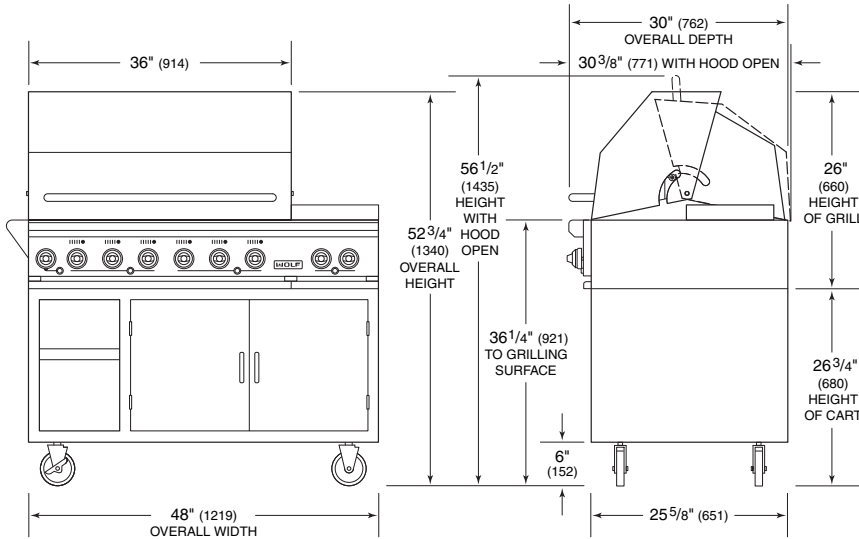

SPECIFICATIONS

48" (1219) Outdoor Grills

Overall Width	48" (1219)
Overall Height	26" (660)
(BI) Models	52 3/4" (1340)
(C) Models	52 3/4" (1340)
Overall Depth	30" (762)
Combustible Enclosure	
Opening Width	50 1/4" (1276)
Opening Depth	27 3/4" (705)
Non-Combustible Enclosure	
Opening Width	48 1/4" (1226)
Opening Depth	26 3/4" (679)
Electrical Supply	110/120 V AC, 60 Hz
	15 amp circuit
Power Cord	9' (2.7 m) 3-prong
Shipping Weight	525-560 lbs
	(238-254 kg)

Unit dimensions may vary to ±1/8" (3).

INSTALLATION SPECIFICATIONS

48" (1219) Outdoor Grills - Built-In (BI) Models

Combustible Enclosure

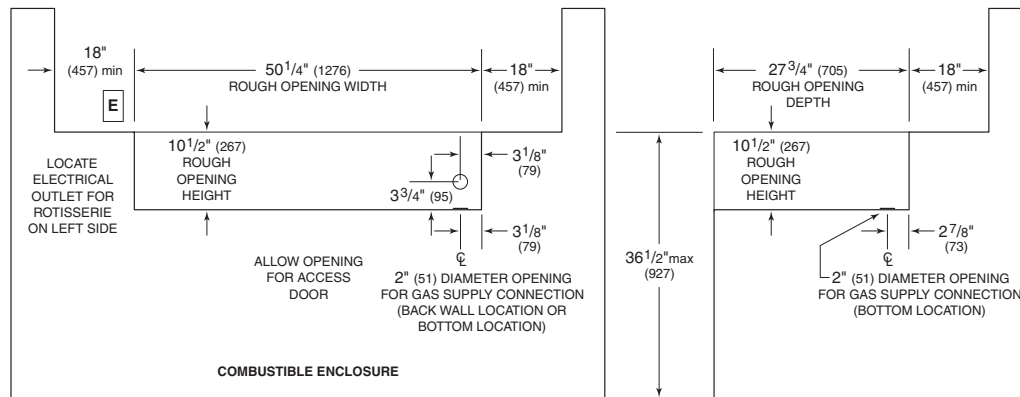

NOTE: Dimensions include insulated liner.

Non-Combustible Enclosure

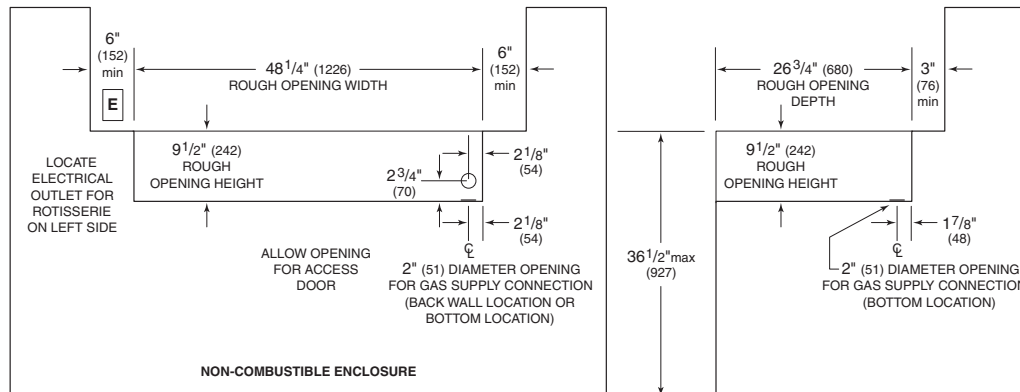

MODEL OPTIONS

48" (1219) Outdoor Grills

Built-In Models

- with Side Burners **BBQ362BI**
- w/o Side Burners **BBQ48BI**

Freestanding Cart Models

- with Side Burners **BBQ362C**
- w/o Side Burners **BBQ48C**

Natural gas models listed; for LP gas add (-LP) to the model number.

Refer to installation instructions shipped with each Wolf product for detailed specifications.



WOLF COOKTOP VENTILATION HOODS

Powerful multi-speed blowers draw odors and smoke into the five-layer mesh filter. Filters remove easily for cleaning. The sculpted classic stainless steel shape not only provides the power you expect from Wolf, but also the beauty you have come to appreciate as well.

Wolf chimney-style cooktop wall and island hoods are recommended for use with Wolf electric and gas cooktops and integrated modules. For Wolf dual fuel ranges, gas ranges, sealed burner rangetops and gas rangetops, a Pro ventilation hood is recommended.

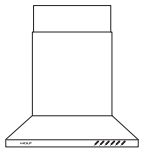

Model CTWH30

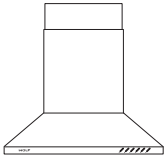

Model CTWH36

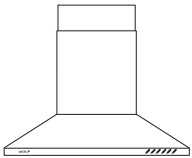

Model IH4227

FEATURES

- Classic** stainless steel finish
- Internal**, in-line and remote blower options
- Front-mounted** controls with LED indicator
- Heavy-duty** stainless steel seamless construction
- Three-speed** blower control
- Filter** clean timer lets you know when the filter needs cleaning
- Delay-off** feature automatically turns unit off
- Sealed** halogen lighting with three settings
- Stainless** steel filter cover with dishwasher-safe aluminum mesh filter
- Heat** sentry feature automatically turns unit on when heat is sensed and automatically adjusts blower speed
- Transition** with backdraft damper included
- Fits** 8' (2.4 m) to 9' (2.7 m) ceilings—flue extension to accommodate 10' (3 m) ceilings is available
- UL** listed to US and Canadian safety standards

COOKTOP VENTILATION HOOD FEATURES

Model CTWH36 shown

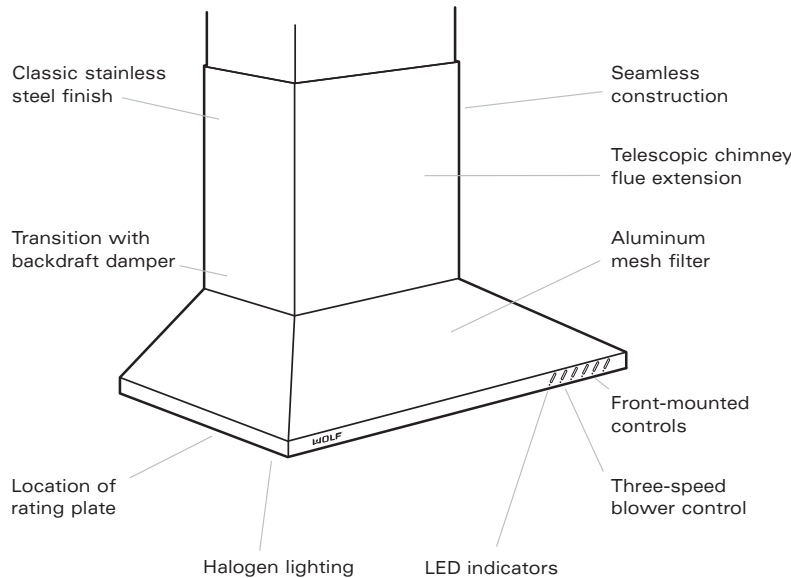

MODEL OPTIONS
Cooktop Ventilation Hoods

Wall Hoods	
30" (762) Width	CTWH30
36" (914) Width	CTWH36
Island Hood	IH4227

Dimensions in parentheses are in millimeters unless otherwise specified.



PLANNING INFORMATION

Chimney-style cooktop wall hoods are 21" (533) deep and come in 30" (762) and 36" (914) widths. The island hood is 42" (1067) wide by 27" (686) deep.

IMPORTANT NOTE: Wolf cooktop wall and island hoods are recommended for use with Wolf electric and gas cooktops along with integrated modules and should be at least as wide as the cooking surface. A Pro ventilation hood is recommended for use with Wolf dual fuel ranges, gas ranges, sealed burner rangetops and gas rangetops. Refer to pages 102–114 for Pro ventilation specifications.

Wolf cooktop wall and island hoods come with a telescopic chimney flue extension that allows you to reach a ceiling height of 8' (2.4 m) to 9' (2.7 m) with a finished look. A flue extension to accommodate 10' (3 m) ceilings is available.

Specifications on the following pages provide overall dimensions, blower and ducting considerations, and installation specifics for cooktop wall and island hoods. We have minimized the information contained in the illustrations, concentrating on the critical information you need to plan your installation. Also refer to the cooktop ventilation recommendations on pages 115–116.

Installation of the cooktop wall or island hood should be 24" (610) to 30" (762) from the bottom of the hood to the countertop.

ELECTRICAL REQUIREMENTS

Wolf cooktop wall and island hoods require a separate, grounded 120 V AC, 60 Hz power supply. The service should have its own 15 amp circuit breaker. Placement of the electrical supply is not critical, as long as you provide a minimum of 12" (305) of 120 V AC power cable for the wall hood and 6' (1.8 m) for the island hood.

Locate electrical within the shaded area shown in the Installation Specifications illustration for your model.

IMPORTANT NOTE: A ground fault circuit interrupter (GFCI) is not recommended and may cause interruption of operation.

You must follow all National Electrical Code regulations. In addition, be aware of local codes and ordinances when installing your service.

WOLF WARRANTY

Wolf products are covered by a two and five year residential warranty (exclusions apply). See warranty details at the end of this guide.

ACCESSORIES

Cooktop Ventilation Hoods

Flue extension to accommodate 10' (3 m) ceilings

30" (762) and 36" (914) wall shields—wall hoods only

8" (203) to 10" (254) round transition

Accessories are available through your Wolf dealer. To obtain local dealer information, visit the Showroom Locator section of our website, wolfappliance.com.



SPECIFICATIONS

Model CTWH30

Overall Width	30" (762)
Overall Height (excluding chimney)	6 7/8" (175)
Overall Height (including chimney)	30 1/2" (775)
Maximum Height (full extension)	48 1/2" (1232)
Overall Depth	21" (533)
Bottom of Hood to Countertop	24" (610) to 30" (762)
Duct Size	8" (203) Round
Discharge	Vertical
Internal Blower*	450 CFM
In-Line Blowers*	600 or 1100 CFM
Remote Blowers*	600, 900, 1200 or 1500 CFM
Electrical Supply	110/120 V AC, 60 Hz 15 amp circuit
Shipping Weight (shell only)	85 lbs (39 kg)

*Blower options vary with the cooking surface. Refer to the cooktop ventilation recommendations on pages 115-116.

OVERALL DIMENSIONS

Cooktop Wall Hoods
Model CTWH30

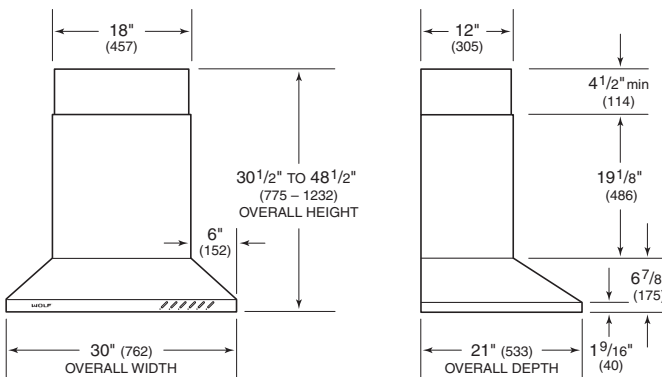

Model CTWH36

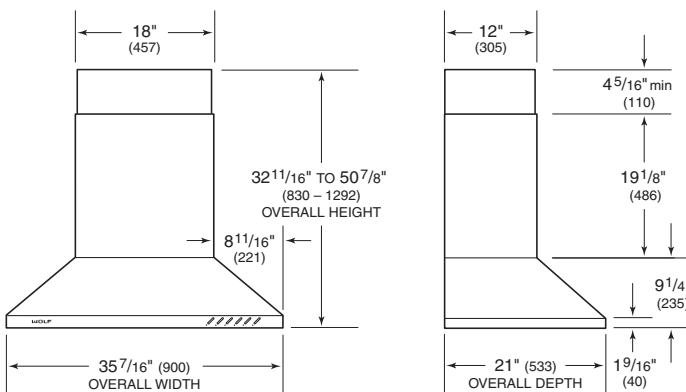

SPECIFICATIONS

Model CTWH36

Overall Width	35 7/16" (900)
Overall Height (excluding chimney)	9 1/4" (235)
Overall Height (including chimney)	32 11/16" (830)
Maximum Height (full extension)	50 7/8" (1292)
Overall Depth	21" (533)
Bottom of Hood to Countertop	24" (610) to 30" (762)
Duct Size	8" (203) Round
Discharge	Vertical
Internal Blowers*	600 or 900 CFM
In-Line Blowers*	600 or 1100 CFM
Remote Blowers*	600, 900, 1200 or 1500 CFM
Electrical Supply	110/120 V AC, 60 Hz 15 amp circuit
Shipping Weight (shell only)	100 lbs (45 kg)

*Blower options vary with the cooking surface. Refer to the cooktop ventilation recommendations on pages 115-116.

Dimensions in parentheses are in millimeters unless otherwise specified.

INSTALLATION SPECIFICATIONS

Cooktop Wall Hoods

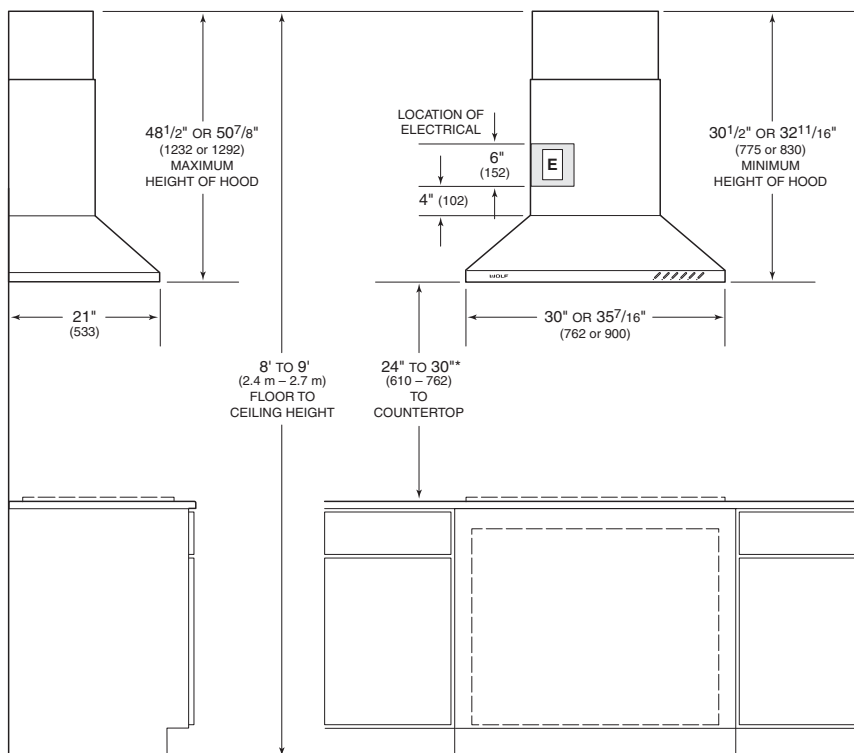

*8' (2.4 m) ceilings will not allow for a 30" (762) maximum height above the countertop. Based on a 36" (914) high countertop, an 8' (2.4 m) ceiling will allow for a maximum height above the countertop of 29 1/2" (749) for Model CTWH30 and 27 5/16" (694) for Model CTWH36.



OVERALL DIMENSIONS

Model IH4227

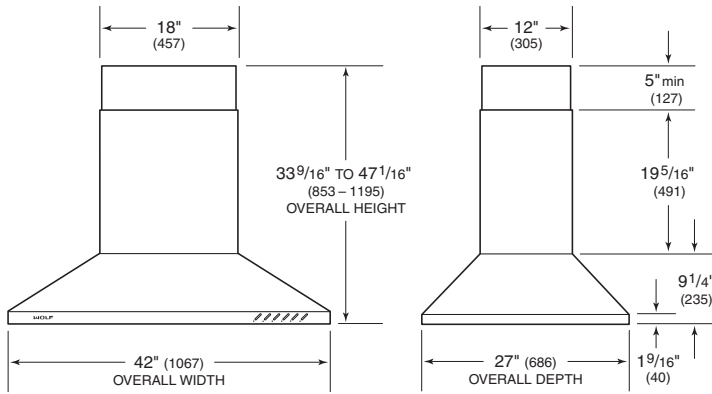

SPECIFICATIONS

Model IH4227

Overall Width	42" (1067)
Overall Height (excluding chimney)	9 1/4" (235)
Overall Height (including chimney)	33 9/16" (853)
Maximum Height (full extension)	47 1/16" (1195)
Overall Depth	27" (686)
Bottom of Hood to Countertop	24" (610) to 30" (762)
Duct Size	8" (203) Round
Discharge	Vertical
Internal Blowers*	600 or 900 CFM
In-Line Blowers*	600 or 1100 CFM
Remote Blowers*	600, 900, 1200 or 1500 CFM
Electrical Supply	110/120 V AC, 60 Hz 15 amp circuit
Shipping Weight (shell only)	110 lbs (50 kg)

INSTALLATION SPECIFICATIONS

Model IH4227

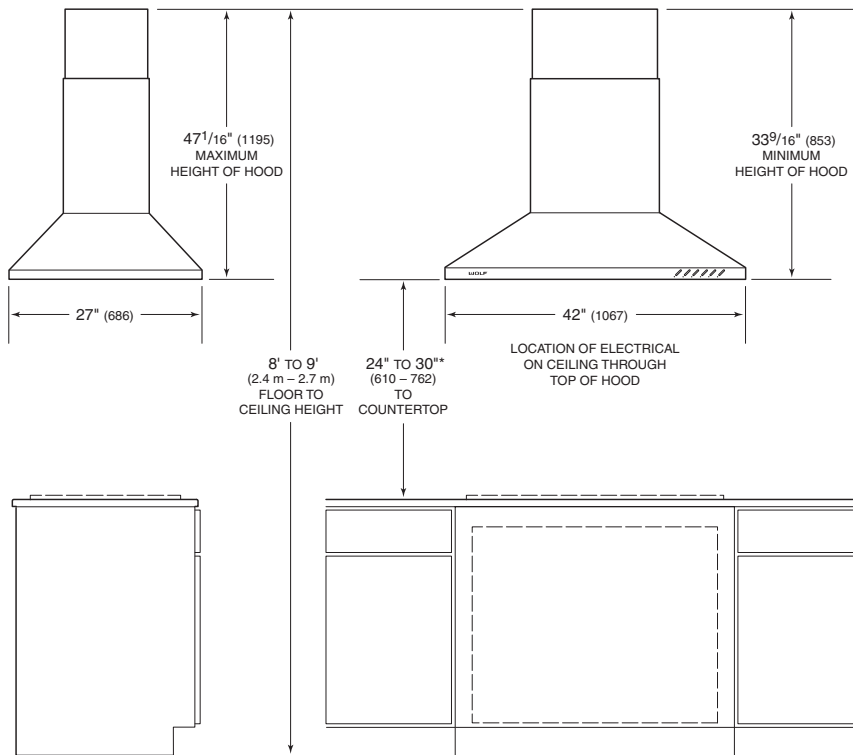

**Blower options vary with the cooking surface. Refer to the cooktop ventilation recommendations on pages 115-116.*

**8' (2.4 m) ceilings will not allow for a 30" (762) maximum height above the countertop. Based on a 36" (914) high countertop, an 8' (2.4 m) ceiling will allow for a maximum height above the countertop of 26 7/16" (672).*

Refer to installation instructions shipped with each Wolf product for detailed specifications.

BLOWER CONSIDERATIONS

Wolf cooktop wall and island hoods are shipped without the blower assembly. Internal, in-line and remote blower assemblies are available. For wall hoods, the remote blower can be mounted on the roof or an exterior wall. For island hoods, the remote blower will be mounted on the roof.

The blower will vary in size and is dictated by the cooking surface, the volume of air that needs to be moved and the length of the duct run. A straight, short duct run with a limited number of elbows and transitions will allow the ventilation hood to perform most efficiently.

A remote mounted blower will minimize the amount of blower noise, but will not eliminate the noise completely. All remote blowers will require a transition to a 10" (254) duct.

IMPORTANT NOTE: Install these ventilation hoods only with a Wolf blower.

DUCTING CONSIDERATIONS

IMPORTANT NOTE: All Wolf cooktop hoods must be vented to the outside. Use only metal ductwork.

Wolf cooktop wall and island hoods have an 8" (203) round vertical discharge. Ducting can run through the roof, external wall or eave. Ducting through an eave requires an internal blower. Refer to the illustrations below.

Wolf cooktop wall and island hoods will operate most efficiently when ductwork does not exceed 50' (15 m) in length.

Local building codes may require the use of make-up air. Consult your local HVAC professional for specific requirements in your area.

Refer to the cooktop ventilation recommendations on pages 115–116.

DUCTING CONSIDERATIONS

Cooktop Wall Hoods

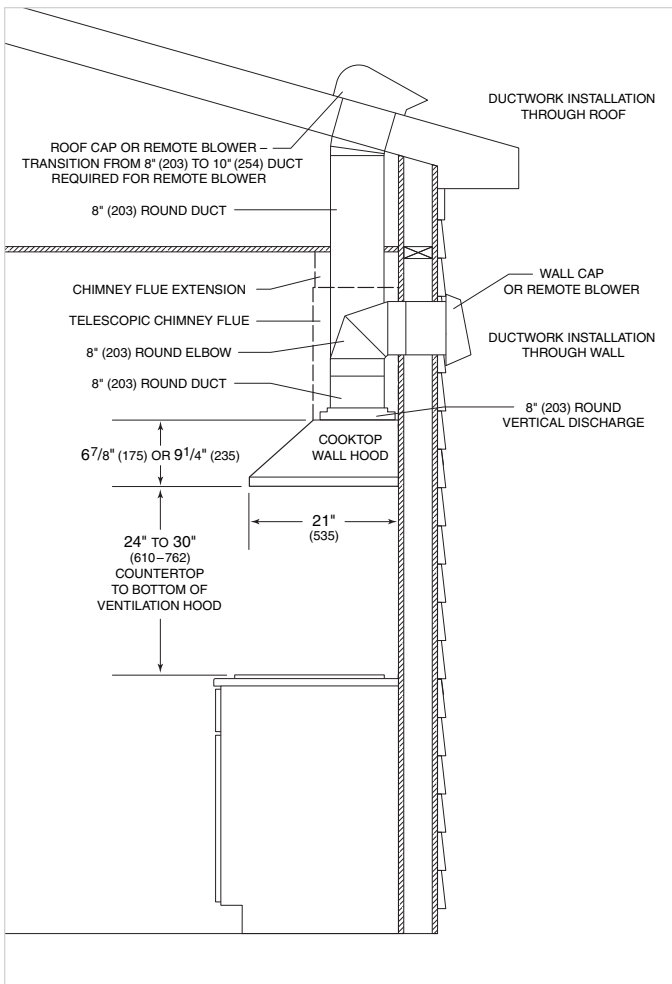

Cooktop Island Hood

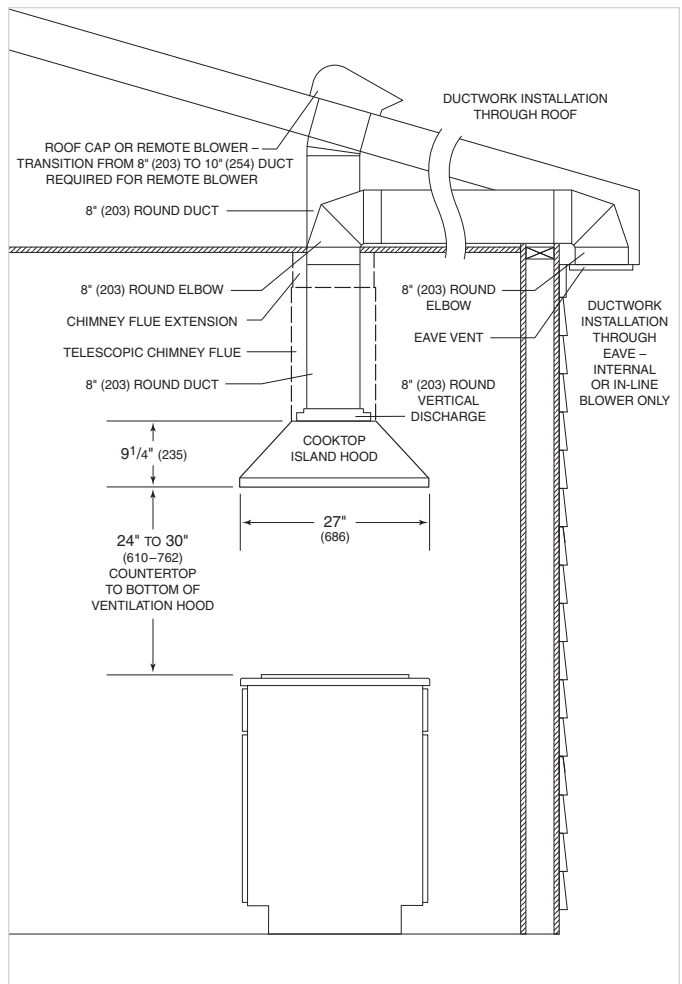



WOLF DOWNDRAFT SYSTEMS

The cooktop downdraft unit rises from the countertop to whisk away odors and smoke into the easy-to-clean, five-layer mesh filter. The control module and top cover are available in the exclusive premium finishes of platinum or carbon stainless steel or the standard classic stainless steel for ease in matching your cooktop.

Wolf downdraft systems come in 30" (762), 36" (914) and 45" (1143) widths and are recommended for use with Wolf framed electric cooktops, gas cooktops and integrated modules.

IMPORTANT NOTE: Wolf downdraft ventilation systems cannot be used with unframed electric cooktops and are not recommended for use with the electric grill, steamer and fryer modules.

A Pro ventilation hood is recommended for use with Wolf dual fuel ranges, gas ranges, sealed burner rangetops and gas rangetops. A downdraft can be used with sealed burner rangetop Models SRT304 and SRT366. An accessory trim kit is necessary for this installation. Contact your Wolf dealer for details.

FEATURES

Classic, platinum and carbon stainless steel finishes available on control module and top cover—Model DD45 available in classic only

Remote-mounted control module

Internal, in-line and remote blower options

Three-speed blower control

Filter clean timer lets you know when the filter needs cleaning

Delay-off feature automatically turns unit off after five minutes, chimney remains up

Stainless steel filter cover with dishwasher-safe aluminum mesh filter

LED indicators

Downdraft control kit, available as a sales accessory for Models DD30 and DD36 (included with Model DD45)—includes control module, top cover, mounting brackets, RJ45 connector and mounting hardware

UL listed to US and Canadian safety standards

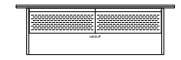

Model DD30

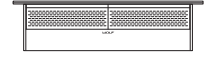

Model DD36

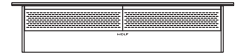

Model DD45

DOWNDRAFT SYSTEM FEATURES

Model DD36 shown

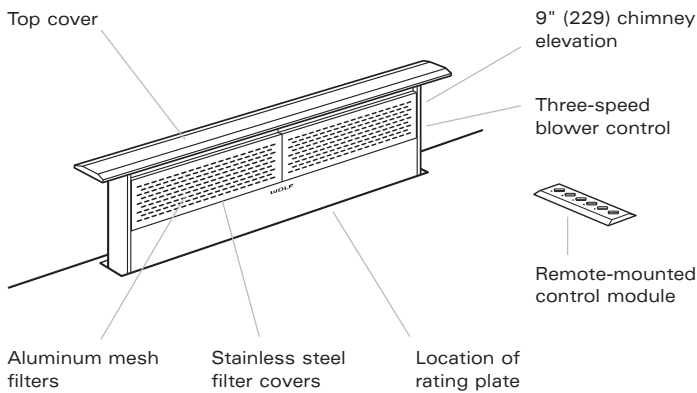

MODEL OPTIONS

Downdraft Systems

(I) Models

500 CFM internal blower included

30" (762) Width	DD30I
36" (914) Width	DD36I
45" (1143) Width	DD45I

(R) Models

Remote blower required

30" (762) Width	DD30R
36" (914) Width	DD36R
45" (1143) Width	DD45R

CONTROL KIT OPTIONS

Downdraft Systems

Model DD30I / DD30R

Classic	DD30CONTROL/S
Platinum	DD30CONTROL/P
Carbon	DD30CONTROL/B

Model DD36I / DD36R

Classic	DD36CONTROL/S
Platinum	DD36CONTROL/P
Carbon	DD36CONTROL/B

Control module and top cover have the stainless steel finish. Control kits also include mounting brackets, RJ45 connector and hardware and are ordered and shipped as sales accessories for Models DD30 and DD36. Control kit components are included with Model DD45.

WOLF WARRANTY

Wolf products are covered by a two and five year residential warranty (exclusions apply). See warranty details at the end of this guide.

ACCESSORIES

Downdraft Systems

Bracket supports for installation of two integrated modules with downdraft (Model DD30 only)

SRT/Downdraft trim kit for sealed burner rangetop Models SRT304 and SRT366

Transitions in various sizes

Accessories are available through your Wolf dealer. To obtain local dealer information, visit the Showroom Locator section of our website, wolfappliance.com.



PLANNING INFORMATION

Wolf downdraft ventilation systems are available in 30" (762), 36" (914) and 45" (1143) widths. The downdraft should be at least as wide as the cooking surface.

Downdraft Model DD30 will fit most 30" (762) wide cabinets, Model DD36 will fit most 36" (914) wide cabinets and Model DD45 will fit most 45 1/2" (1156) wide cabinets. It is recommended that oversized cabinets be used for easier installation. Cabinet backs may need to be removed.

IMPORTANT NOTE: To install a downdraft system and a Wolf cooktop, you must allow for a minimum 25 1/8" (638) flat counter space from front to back. A countertop with a raised lip and/or backsplash may not allow enough space for proper installation. 2 3/8" (60) of flat countertop is required behind the cooktop and 1 3/4" (44) is necessary between the back edge of the cooktop and inside of cabinet back.

IMPORTANT NOTE: This appliance must be used with a Wolf-approved control module and top cover.

The remote-mounted control module is available as a sales accessory for Models DD30 and DD36 and is included with Model DD45. Installation of the control module must be within 10' (3 m) of the downdraft assembly and a minimum of 4" (102) from the outer edge of cooktop element or burner. You will be required to drill three holes and connect the downdraft to the control module with the provided wire.

Specifications on the following pages provide overall dimensions, blower and ducting considerations, and installation specifics for downdraft ventilation systems. Also refer to the cooktop ventilation recommendations on pages 115-116.

If a Model DD30 is installed in combination with two integrated modules, an integrated module support for downdraft ventilation is required. Contact your Wolf dealer for information on accessory components.

OVERALL DIMENSIONS

Downdraft Systems

Models DD30I / DD30R

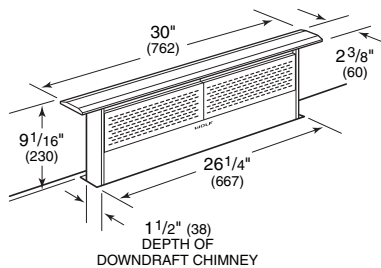

Models DD36I / DD36R

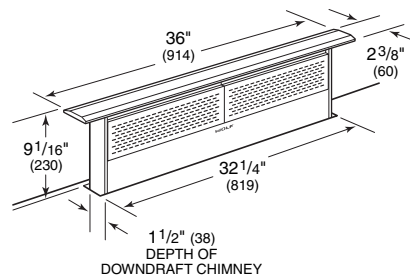

Models DD45I / DD45R

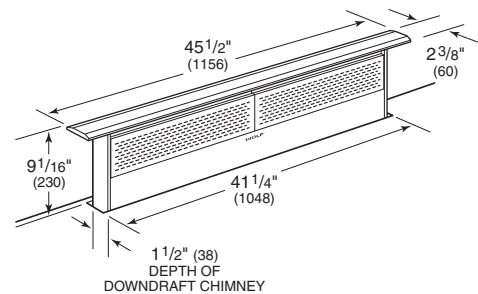

Dimensions in parentheses are in millimeters unless otherwise specified.



INSTALLATION SPECIFICATIONS

Downdraft Systems

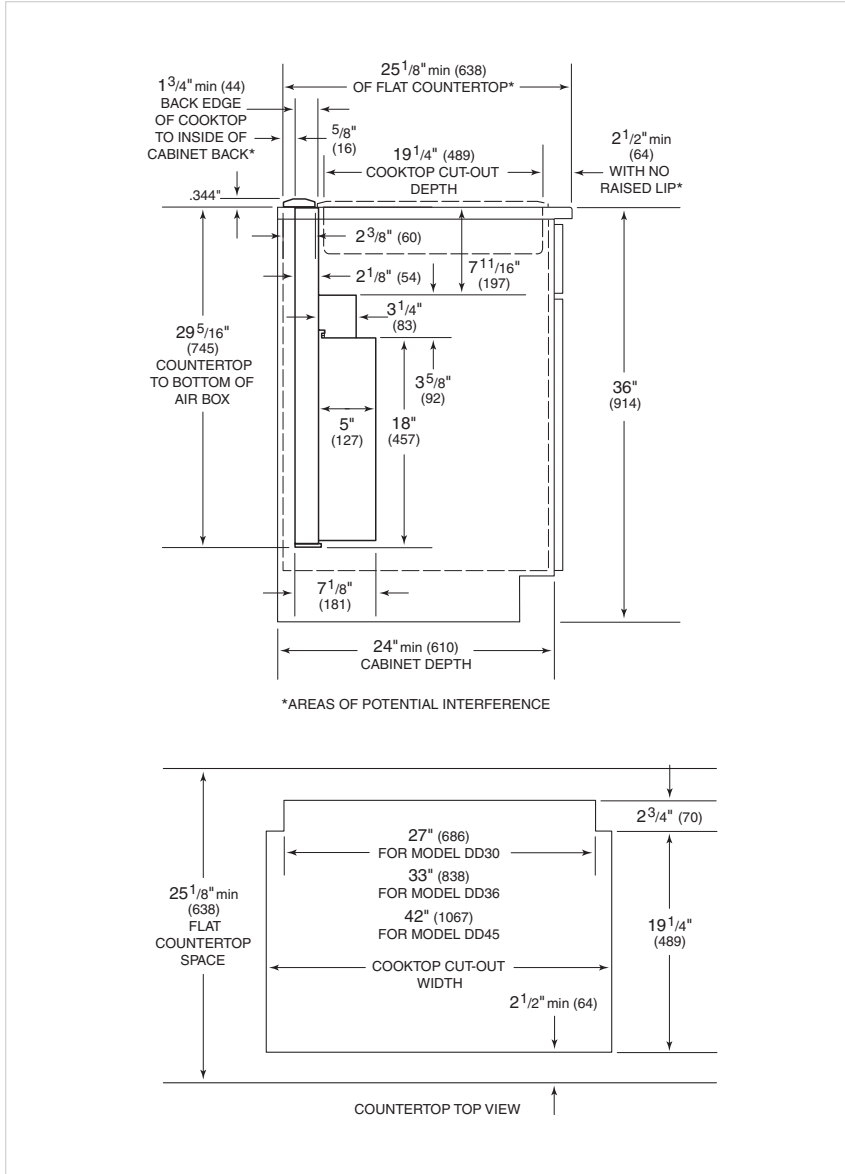

Refer to installation instructions shipped with each Wolf product for detailed specifications.

SPECIFICATIONS

Models DD30I / DD30R

Overall Width	30" (762)
Overall Height (above countertop)	9 1/16" (230)
Overall Depth	2 3/8" (60)
Duct Size (DD30I)	3 1/4" (83) x 10" (254)
Duct Size (DD30R)	3 1/4" (83) x 14" (356)
Discharge	Adjustable
Blower (DD30I)	500 CFM Internal
Blower Options* (DD30R)	1100 CFM In-Line, 900, 1200 or 1500 CFM Remote
Electrical Supply	110/120 V AC, 60 Hz 15 amp circuit
Power Cord	2 1/2' (.8 m) 3-prong
Shipping Weight	75 lbs (34 kg)

SPECIFICATIONS

Models DD36I / DD36R

Overall Width	36" (914)
Overall Height (above countertop)	9 1/16" (230)
Overall Depth	2 3/8" (60)
Duct Size (DD36I)	3 1/4" (83) x 10" (254)
Duct Size (DD36R)	3 1/4" (83) x 14" (356)
Discharge	Adjustable
Blower (DD36I)	500 CFM Internal
Blower Options* (DD36R)	1100 CFM In-Line, 900, 1200 or 1500 CFM Remote
Electrical Supply	110/120 V AC, 60 Hz 15 amp circuit
Power Cord	2 1/2' (.8 m) 3-prong
Shipping Weight	80 lbs (36 kg)

SPECIFICATIONS

Models DD45I / DD45R

Overall Width	45 1/2" (1156)
Overall Height (above countertop)	9 1/16" (230)
Overall Depth	2 3/8" (60)
Duct Size (DD45I)	3 1/4" (83) x 10" (254)
Duct Size (DD45R)	3 1/4" (83) x 14" (356)
Discharge	Adjustable
Blower (DD45I)	500 CFM Internal
Blower Options* (DD45R)	1100 CFM In-Line, 900, 1200 or 1500 CFM Remote
Electrical Supply	110/120 V AC, 60 Hz 15 amp circuit
Power Cord	2 1/2' (.8 m) 3-prong
Shipping Weight	85 lbs (39 kg)

*Refer to the cooktop ventilation recommendations on pages 115-116.



ELECTRICAL REQUIREMENTS

Wolf downdraft ventilation systems require a separate, grounded 120 V AC, 60 Hz power supply. The service should have its own 15 amp circuit breaker, and a grounded 3-prong receptacle should be located within reach of the 2 1/2' (.8 m) power cord. The specific location of the outlet is not critical as long as it is within reach of the power cord that is located midway, top and bottom, on the right side of the downdraft.

IMPORTANT NOTE: If Model DD30 is to be installed in a 30" (762) wide cabinet, Model DD36 in a 36" (914) wide cabinet or Model DD45 in a 45 1/2" (1156) wide cabinet, the electrical outlet cannot be located on the back wall of the cabinet. The outlet may be placed in adjacent cabinetry.

Locate electrical within the shaded area shown in the Installation Specifications illustrations.

IMPORTANT NOTE: A ground fault circuit interrupter (GFCI) is not recommended and may cause interruption of operation.

You must follow all National Electrical Code regulations. In addition, be aware of local codes and ordinances when installing your service.

BLOWER CONSIDERATIONS

Except for Models DD30I, DD36I and DD45I, which include a 500 CFM internal blower, Wolf downdrafts are shipped without the blower assembly. In-line and remote blower assemblies are available. The blower will vary in size and is dictated by the cooking surface, the volume of air that needs to be moved and the length of the duct run. A straight, short duct run with a limited number of elbows and transitions will allow the ventilation hood to perform most efficiently.

Wolf downdraft ventilation systems are designed for use with 3 1/4" (83) x 10" (254) ductwork for Models DD30I, DD36I and DD45I and 3 1/4" (83) x 14" (356) ductwork for Models DD30R, DD36R and DD45R. Each can be transitioned to 8" (203) or 10" (254) round ductwork.

A remote-mounted blower will minimize the amount of blower noise, but will not eliminate the noise completely.

IMPORTANT NOTE: Install this downdraft system only with a Wolf blower.

Refer to the cooktop ventilation recommendations on pages 115-116.

INSTALLATION SPECIFICATIONS

Location of Electrical Supply

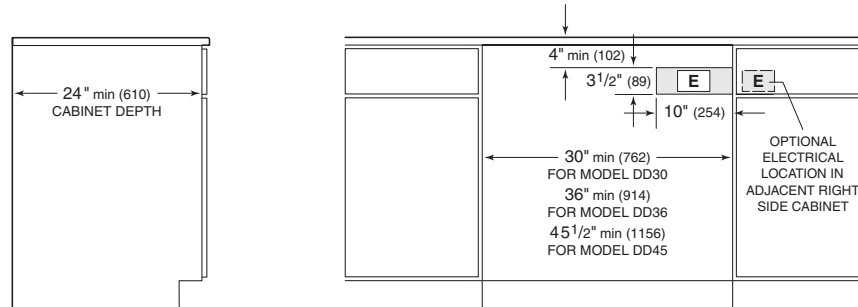

IMPORTANT NOTE: Certain installations may require that the electrical supply be placed in an adjacent cabinet within reach of the power cord. Choose the location shown in the illustration that best suits your installation.

Dimensions in parentheses are in millimeters unless otherwise specified.



DUCTING CONSIDERATIONS

Wolf downdraft systems have an adjustable discharge that will allow you to negotiate ducting around floor joists and other obstacles. Three different discharge locations are available with side-to-side adjustment for accurate alignment of ductwork. Refer to the illustration below for discharge location and adjustment.

IMPORTANT NOTE: All Wolf downdraft systems must be vented to the outside. Use only metal ductwork.

For best performance, 10" (254) round ductwork is recommended. The downdraft will operate most efficiently when ductwork does not exceed 40' (12 m) in length.

Choose the ducting option that allows the shortest length of ductwork and a minimum number of elbows and transitions. Refer to the illustration below for ducting options.

Refer to installation instructions shipped with each Wolf product for detailed specifications.

DISCHARGE LOCATION
Downdraft Systems

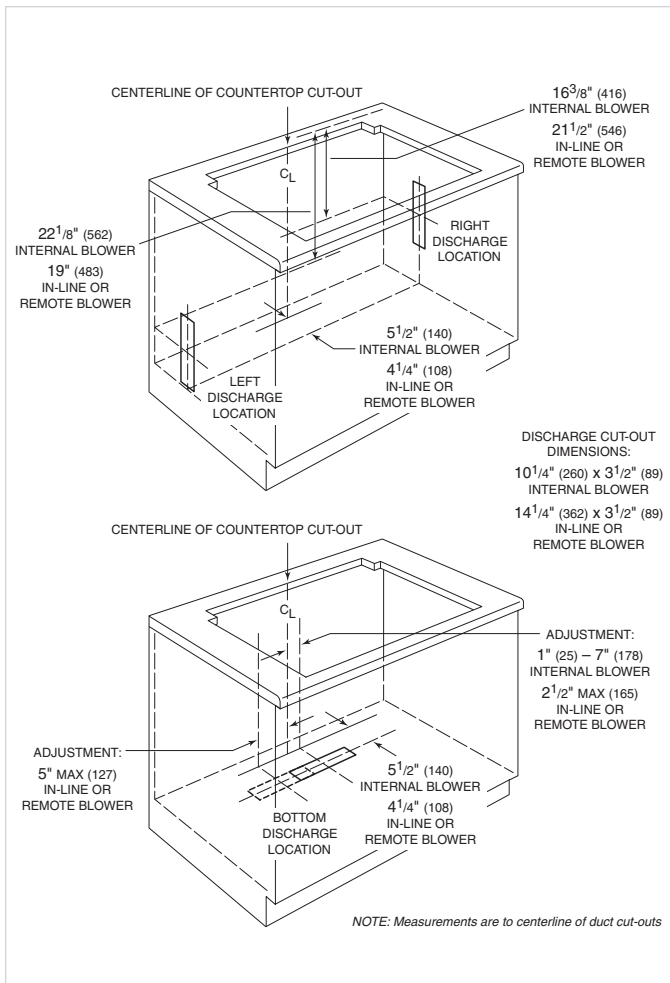

DUCTING OPTIONS
Downdraft Systems

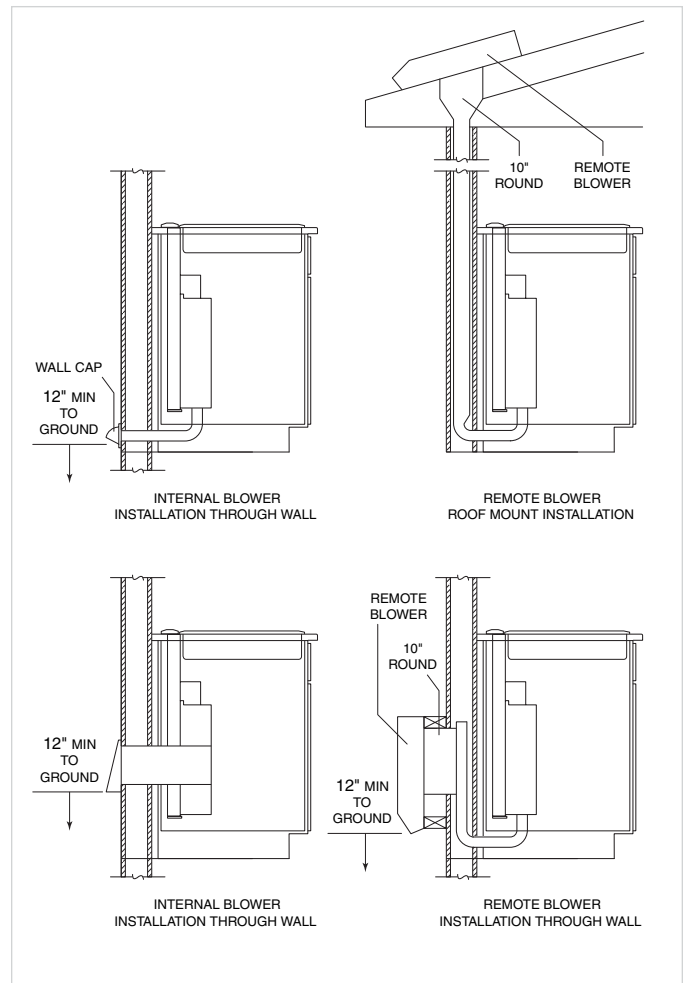



WOLF PRO VENTILATION HOODS

Wolf Pro wall and island hoods provide the ultimate in ventilation. With standard elements like heat sentry and dual-setting halogen lighting, Wolf elevates the need for ventilation to an enjoyable perk.

Pro wall and island hoods are recommended for use with all Wolf cooking appliances.

IMPORTANT NOTE: For optimal performance in wall hood applications, a Pro 27" (686) deep wall hood is recommended for use with ranges and rangetops that contain a charbroiler or griddle.

The deepest of the Wolf Pro wall hoods, the 27" (686) model provides an additional exclusive feature—heat lamps.

All Pro wall and island hoods are available in classic stainless steel. Rail option hoods (R) come with a classic stainless steel decorative rail and stand-offs. Optional platinum and brass rails to match dual fuel range and sealed burner rangetop bezels are available as sales accessories.

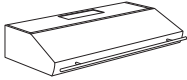
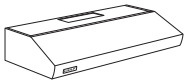

Low-Profile Wall Hoods

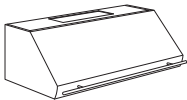

24" (610) Wall Hoods

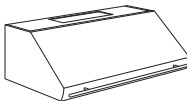

27" (686) Wall Hoods

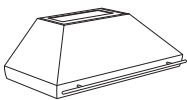
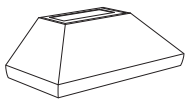

Wall Chimney Hoods

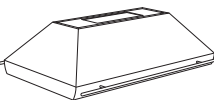

Island Hoods

Dimensions in parentheses are in millimeters unless otherwise specified.

MODEL OPTIONS

Pro Ventilation Hoods

Pro Low-Profile Wall Hoods

30" (762) Width	PW302210
36" (914) Width	PW362210
42" (1067) Width	PW422210
48" (1219) Width	PW482210

Pro 24" (610) Deep Wall Hoods

30" (762) Width	PW302418
36" (914) Width	PW362418
42" (1067) Width	PW422418
48" (1219) Width	PW482418
54" (1372) Width	PW542418
60" (1524) Width	PW602418
66" (1676) Width	PW662418

Pro 27" (686) Deep Wall Hoods

30" (762) Width	PW302718
36" (914) Width	PW362718
42" (1067) Width	PW422718
48" (1219) Width	PW482718
54" (1372) Width	PW542718
60" (1524) Width	PW602718
66" (1676) Width	PW662718

Pro Wall Chimney Hoods

36" (914) Width	PWC362418
42" (1067) Width	PWC422418
48" (1219) Width	PWC482418
54" (1372) Width	PWC542418

Pro Island Hoods

36" (914) Width	PI363418
42" (1067) Width	PI423418
54" (1372) Width	PI543418
66" (1676) Width	PI663418

Models without decorative rail(s) listed; for hoods with rail(s) add (R) to the model number.

IMPORTANT NOTE: For optimal performance in wall hood applications, a Pro 27" (686) deep wall hood is recommended for use with ranges and rangetops that contain a charbroiler or griddle.



FEATURES

Low-profile, 24" (610) and 27" (686) deep wall ventilation hoods in a variety of widths with classic stainless steel finish

Wall chimney ventilation hoods in a variety of widths with classic stainless steel finish—optional duct covers to complete the chimney design are available as sales accessories

Island ventilation hoods in a variety of widths with classic stainless steel finish

Rail option wall hoods (R) come with a classic stainless steel decorative rail and stand-offs—optional platinum or brass rail available to match dual fuel range and sealed burner rangetop bezels

Rail option island hoods (R) come with classic stainless steel decorative rails and stand-offs for both sides of the hood—optional platinum or brass rails available to match dual fuel range and sealed burner rangetop bezels

Internal, in-line and remote blower options

Heavy-duty 16-gauge brushed stainless steel construction

Stainless steel enclosed liner

Continually welded seams, hemmed edges and sides, and hand-finished craftsmanship

Recessed easy-access controls

Infinite-speed blower control

Heat sentry feature automatically turns unit on when heat is sensed and automatically adjusts blower speed

Halogen lighting with two settings

Heat lamps on 27" (686) deep wall hoods—two R40 250-watt-maximum bulbs required (bulbs not included)

Removable, dishwasher-safe, restaurant-grade stainless steel baffle filters and grease cups

Transition with backdraft damper included (not included with low-profile hoods)

WOLF
WARRANTY

Wolf products are covered by a two and five year residential warranty (exclusions apply). See warranty details at the end of this guide.

PRO VENTILATION HOOD FEATURES

Model PW482718R shown

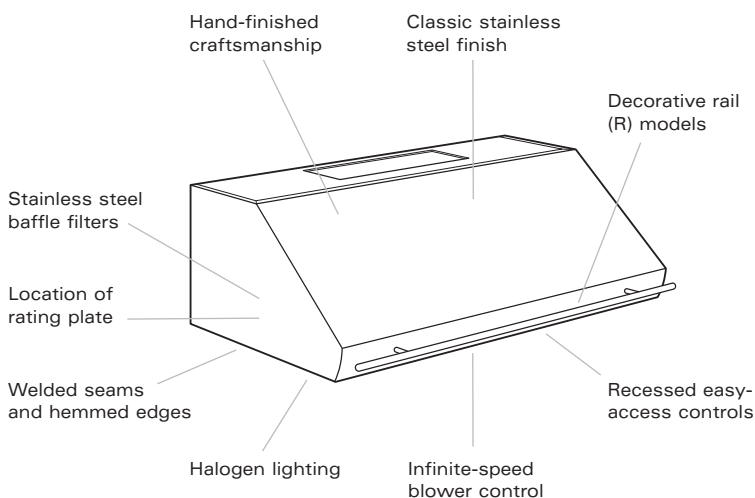

ACCESSORIES

Pro Ventilation Hoods

Platinum or brass decorative rails and stand-offs

38" (965) high classic stainless steel backsplash with or without warming racks (wall hoods)

6" (152), 12" (305), 18" (457) and 24" (610) high classic stainless steel duct covers

Horizontal discharge kits—24" (610) and 27" (686) deep wall hoods only

Recirculating kit—available for certain wall hood models

Transitions for 8" (203) and 10" (254) round duct—low-profile hoods

Accessories are available through your Wolf dealer. To obtain local dealer information, visit the Showroom Locator section of our website, wolfappliance.com.



PLANNING INFORMATION

Pro low-profile wall hoods are available in 30" (762), 36" (914), 42" (1067) and 48" (1219) widths.

Pro 24" (610) deep wall hoods are available in 30" (762), 36" (914), 42" (1067), 48" (1219), 54" (1372), 60" (1524) and 66" (1676) widths.

Pro 27" (686) deep wall hoods are available in 30" (762), 36" (914), 42" (1067), 48" (1219), 54" (1372), 60" (1524) and 66" (1676) widths.

Pro wall chimney hoods are available in 36" (914), 42" (1067), 48" (1219) and 54" (1372) widths.

Pro island hoods are available in 36" (914), 42" (1067), 54" (1372) and 66" (1676) widths.

IMPORTANT NOTE: For optimal performance in wall hood applications, a Pro 27" (686) deep wall hood is recommended for use with ranges and rangetops that contain a charbroiler or griddle.

Specifications on the following pages provide overall dimensions, blower and ducting considerations, and installation specifics for Pro wall and island hoods. We have minimized the information contained in the illustrations, concentrating on the critical information you need to plan your installation. Also refer to the Pro ventilation recommendations on pages 117-120.

The overall dimensions illustrations include the optional rail dimensions. Overall width, height and depth dimensions will remain the same if a decorative rail is not to be used.

Pro wall hoods should be at least as wide as the cooking surface; an overlap of 3" (76) on either side is recommended. Island hoods should always be larger than the cooking surface by a minimum of 3" (76) on each side.

Installation of all Pro wall and island hoods should be 30" (762) to 36" (914) from the bottom of the hood to the countertop.

Optional classic stainless steel duct covers are available in heights of 6" (152), 12" (305), 18" (457) and 24" (610) for all Pro wall and island hoods.

ELECTRICAL REQUIREMENTS

Wolf Pro wall and island hoods require a separate, grounded 120 V AC, 60 Hz power supply. The service should have its own 15 amp circuit breaker. Placement of the electrical supply is not critical, as long as you provide enough 120 V AC power cable to make your electrical connections. Note that for some wall hoods, placement of the electrical supply will differ between vertical and horizontal discharge locations. Refer to pages 111-114 for blower and ducting considerations to determine discharge location.

Locate electrical within the shaded area shown in the Installation Specifications illustration for your model.

IMPORTANT NOTE: A ground fault circuit interrupter (GFCI) is not recommended and may cause interruption of operation.

You must follow all National Electrical Code regulations. In addition, be aware of local codes and ordinances when installing your service.

ACCESSORIES

Optional accessories are available through your Wolf dealer. To obtain local dealer information, visit the Showroom Locator section of our website, wolfappliance.com.

Dimensions in parentheses are in millimeters unless otherwise specified.



OVERALL DIMENSIONS

Pro Low-Profile Wall Hoods

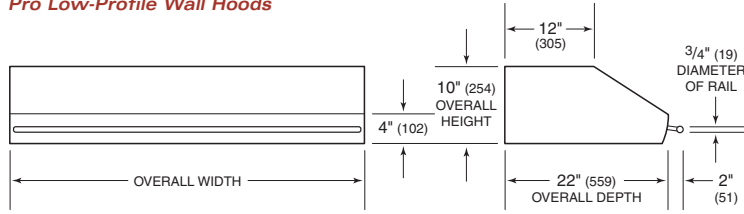

Pro 24" (610) Deep Wall Hoods

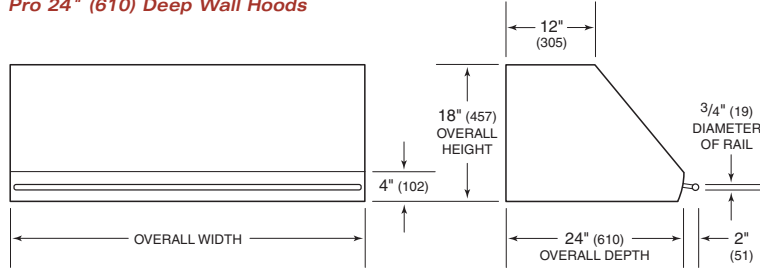

Pro 27" (686) Deep Wall Hoods

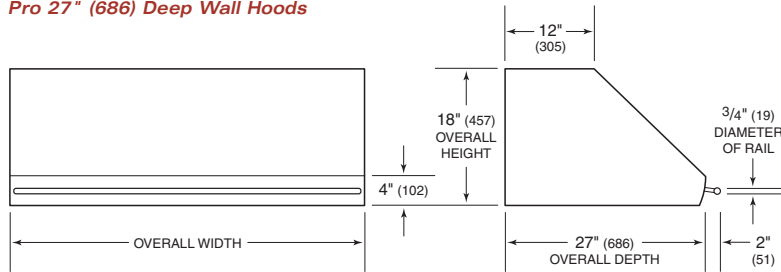

Pro Wall Chimney Hoods

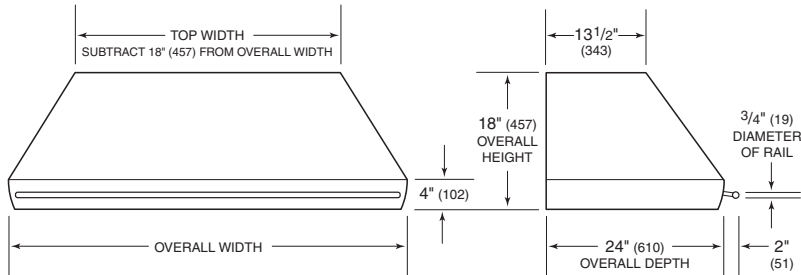

Pro Island Hoods

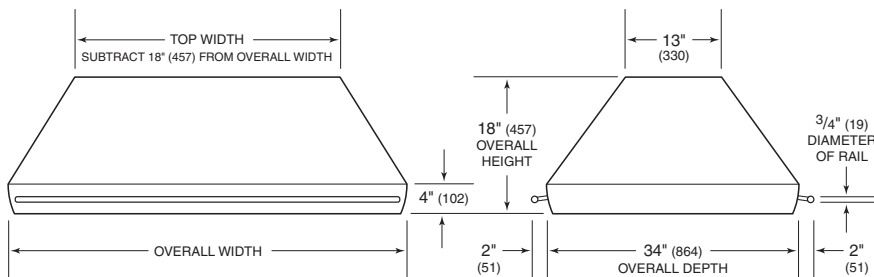

Unit dimensions may vary to ±1/8" (3).

Refer to installation instructions shipped with each Wolf product for detailed specifications.



INSTALLATION SPECIFICATIONS

Pro Wall Hoods

SPECIFICATIONS

Pro Low-Profile Wall Hoods

Overall Width	
PW302210	30" (762)
PW362210	36" (914)
PW422210	42" (1067)
PW482210	48" (1219)
Overall Height	10" (254)
Overall Depth	22" (559) excluding rail
Bottom of Hood to Countertop	30" (762) to 36" (914)
Duct Size*	10" (254) Round rec
Discharge	Vertical or Horizontal
Internal Blower**	500 CFM
In-Line Blower**	600 CFM
Remote Blowers**	600 or 900 CFM
Electrical Supply	110/120 V AC, 60 Hz 15 amp circuit
Shipping Weight (shell only)	39-55 lbs (18-25 kg)

*Duct size may vary based on blower and transition used. See installation instructions for details.

**Blower options vary with the size of hood and cooking surface. Refer to the Pro ventilation recommendations on pages 117-120.

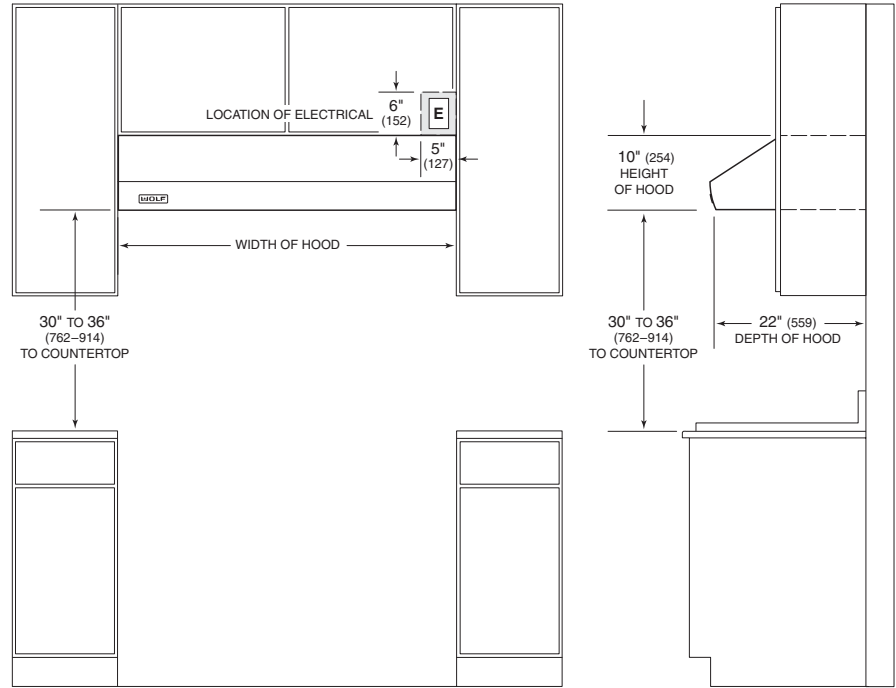

NOTE: Pro low-profile wall hoods have an adjustable discharge.

SPECIFICATIONS

Pro 24" (610) Deep Wall Hoods

Overall Width	
PW302418	30" (762)
PW362418	36" (914)
PW422418	42" (1067)
PW482418	48" (1219)
PW542418	54" (1372)
PW602418	60" (1524)
PW662418	66" (1676)
Overall Height	18" (457)
Overall Depth	24" (610) excluding rail
Bottom of Hood to Countertop	30" (762) to 36" (914)
Duct Size	10" (254) Round
Discharge	Vertical or Horizontal*
Internal Blowers**	600, 900 or 1200 CFM
In-Line Blowers**	600 or 1100 CFM
Remote Blowers**	600, 900, 1200 or 1500 CFM
Electrical Supply	110/120 V AC, 60 Hz 15 amp circuit
Shipping Weight (shell only)	84-148 lbs (38-67 kg)

*Horizontal discharge applications require a horizontal discharge kit.

**Blower options vary with the size of hood and cooking surface. Refer to the Pro ventilation recommendations on pages 117-120.

INSTALLATION SPECIFICATIONS

Pro 24" (610) Deep Wall Hoods

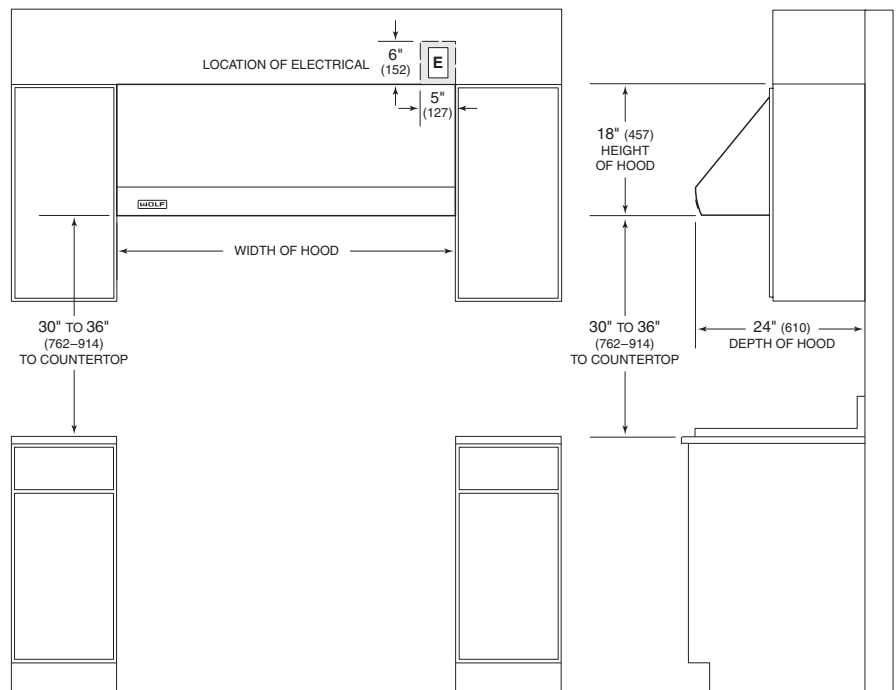

NOTE: Pro 24" (610) deep wall hoods have a vertical discharge. A horizontal discharge kit is available as a sales accessory.



INSTALLATION SPECIFICATIONS

Pro 27" (686) Deep Wall Hoods

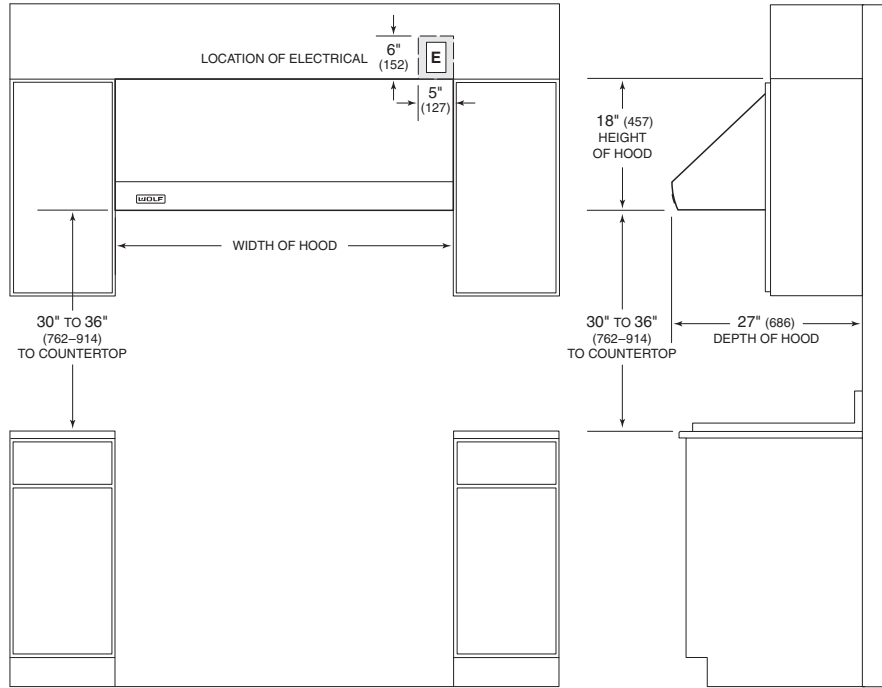

NOTE: Pro 27" (686) deep wall hoods have a vertical discharge. A horizontal discharge kit is available as a sales accessory.

SPECIFICATIONS

Pro 27" (686) Deep Wall Hoods

Overall Width	
PW302718	30" (762)
PW362718	36" (914)
PW422718	42" (1067)
PW482718	48" (1219)
PW542718	54" (1372)
PW602718	60" (1524)
PW662718	66" (1676)
Overall Height	18" (457)
Overall Depth	27" (686) excluding rail
Bottom of Hood to Countertop	30" (762) to 36" (914)
Duct Size	10" (254) Round
Discharge	Vertical or Horizontal*
Internal Blowers**	600, 900 or 1200 CFM
In-Line Blowers**	600 or 1100 CFM
Remote Blowers**	600, 900, 1200 or 1500 CFM
Electrical Supply	110/120 V AC, 60 Hz 15 amp circuit
Shipping Weight (shell only)	92-163 lbs (42-74 kg)

*Horizontal discharge applications require a horizontal discharge kit.

**Blower options vary with the size of hood and cooking surface. Refer to the Pro ventilation recommendations on pages 117-120.

INSTALLATION SPECIFICATIONS

Pro Wall Chimney Hoods

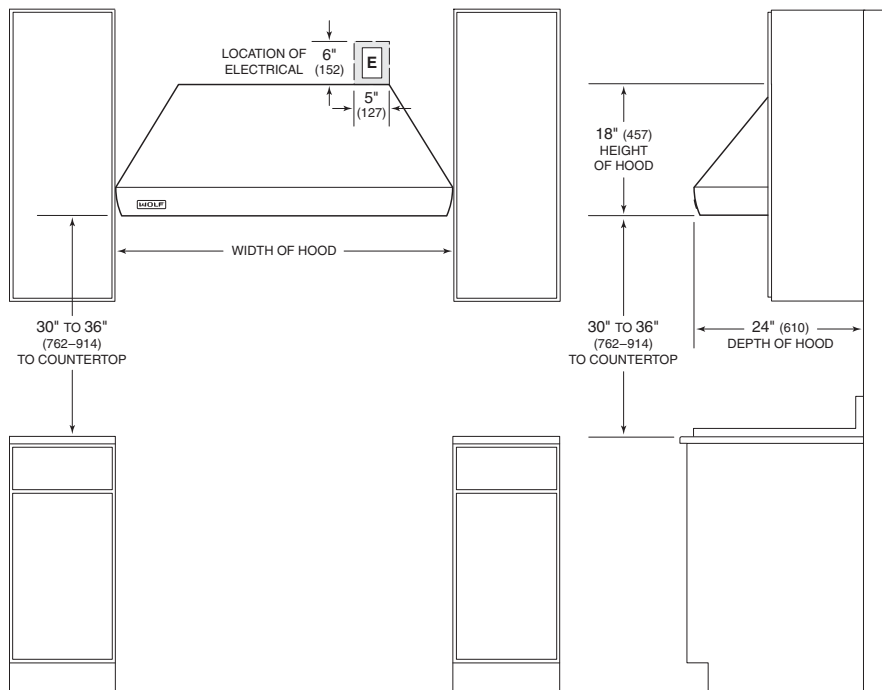

NOTE: Pro wall chimney hoods have a vertical discharge.

SPECIFICATIONS

Pro Wall Chimney Hoods

Overall Width	
PWC362418	36" (914)
PWC422418	42" (1067)
PWC482418	48" (1219)
PWC542418	54" (1372)
Overall Height	18" (457)
Overall Depth	24" (610) excluding rail
Bottom of Hood to Countertop	30" (762) to 36" (914)
Duct Size	10" (254) Round
Discharge	Vertical
Internal Blowers*	600, 900 or 1200 CFM
In-Line Blower*	1100 CFM
Remote Blowers*	600, 900, 1200 or 1500 CFM
Electrical Supply	110/120 V AC, 60 Hz 15 amp circuit
Shipping Weight (shell only)	78-106 lbs (35-48 kg)

*Blower options vary with the size of hood and cooking surface. Refer to the Pro ventilation recommendations on pages 117-120.



INSTALLATION SPECIFICATIONS

Pro Island Hoods

SPECIFICATIONS

Pro Island Hoods

Overall Width	
PI363418	36" (914)
PI423418	42" (1067)
PI543418	54" (1372)
PI663418	66" (1676)
Overall Height	18" (457)
Overall Depth	34" (864) excluding rails
Bottom of Hood to Countertop	30" (762) to 36" (914)
Duct Size	10" (254) Round
Discharge	Vertical
Internal Blower*	1200 CFM
In-Line Blower*	1100 CFM
Remote Blowers*	900, 1200 or 1500 CFM
Electrical Supply	110/120 V AC, 60 Hz 15 amp circuit
Shipping Weight (shell only)	95-168 lbs (43-76 kg)

**Blower options vary with the size of hood and cooking surface. Refer to the Pro ventilation recommendations on pages 117-120.*

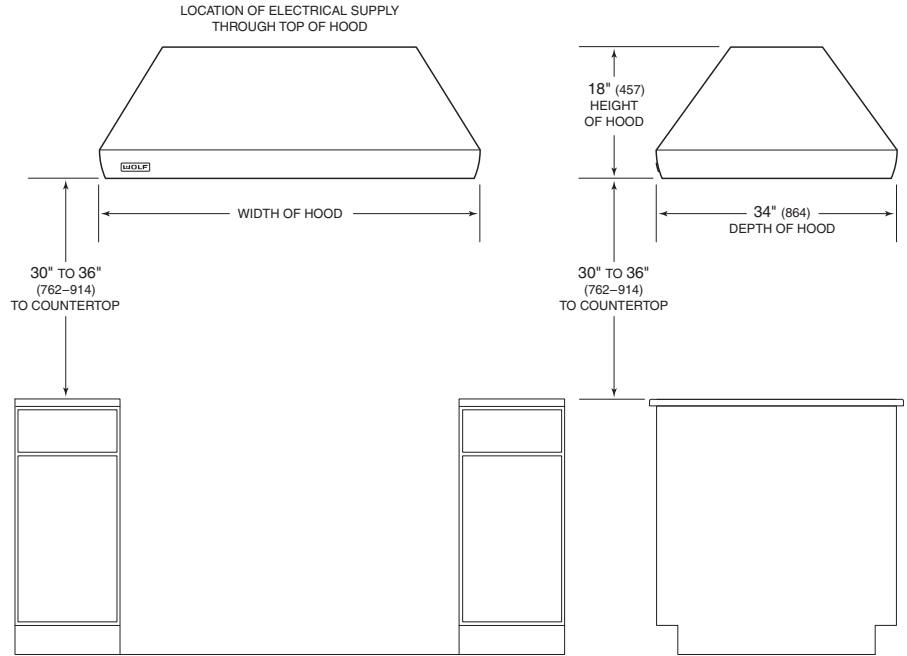

Dimensions in parentheses are in millimeters unless otherwise specified.

Refer to installation instructions shipped with each Wolf product for detailed specifications.



WOLF PRO HOOD LINERS

Wolf Pro hood liners allow you to incorporate superior ventilation within your kitchen design. Whether you prefer French country or modernist, the Pro hood liners take care of the interior design, with true superior ventilation. All you have to do is decide what it will look like.

Sometimes referred to as power packs, these liners bring all the controls, lighting and convenience of our new ventilation line for those applications with a custom exterior treatment.

Wolf Pro hood liners are recommended for use with all Wolf cooking appliances and are available to accommodate 36" (914), 42" (1067), 48" (1219), 54" (1372) and 60" (1524) wide hoods.

FEATURES

Stainless steel enclosed liner with seamed construction

Internal, in-line and remote blower options

Recessed easy-access controls

Infinite-speed blower control

Heat sentry feature automatically turns unit on when heat is sensed and automatically adjusts blower speed

Halogen lighting with two settings

Removable, dishwasher-safe, restaurant-grade stainless steel baffle filters

Transition with backdraft damper included

PLANNING INFORMATION

Pro hood liners are available to accommodate 36" (914), 42" (1067), 48" (1219), 54" (1372) and 60" (1524) wide hoods.

The ventilation hood should be at least as wide as the cooking surface. It is recommended that the hood overlap the cooking surface by 3" (76) on either side.

Installation of all Pro hood liners should be 30" (762) to 36" (914) from the bottom of the decorative hood to the countertop.

The specifications provide overall dimensions and installation specifics for Pro hood liners. Refer to pages 111–114 for blower and ducting considerations and pages 117–120 for Pro ventilation recommendations.

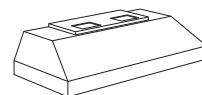

Pro Hood Liner

ELECTRICAL REQUIREMENTS

Wolf Pro hood liners require a separate, grounded 120 V AC, 60 Hz power supply. The service should have its own 15 amp circuit breaker. Placement of the electrical supply is not critical, as long as you provide enough 120 V AC power cable to make your electrical connections.

Locate electrical within the shaded area shown in the Installation Specifications illustration.

IMPORTANT NOTE: A ground fault circuit interrupter (GFCI) is not recommended and may cause interruption of operation.

You must follow all National Electrical Code regulations. In addition, be aware of local codes and ordinances when installing your service.

MODEL OPTIONS

Pro Hood Liners

For 36" (914) Hood	PL342212
For 42" (1067) Hood	PL402212
For 48" (1219) Hood	PL462212
For 54" (1372) Hood	PL522212
For 60" (1524) Hood	PL582212

ACCESSORIES

Pro Hood Liners

38" (965) high classic stainless steel backsplash with or without warming racks

Accessories are available through your Wolf dealer. To obtain local dealer information, visit the Showroom Locator section of our website, wolfappliance.com.



SPECIFICATIONS

Pro Hood Liners

Overall Width	
PL342212	34 ³ / ₈ " (873)
PL402212	40 ³ / ₈ " (1026)
PL462212	46 ³ / ₈ " (1178)
PL522212	52 ³ / ₈ " (1330)
PL582212	58 ³ / ₈ " (1483)
Overall Height	12" (305)
Overall Depth	22 ¹ / ₂ " (572)
Bottom of Hood to Countertop	30" (762) to 36" (914)
Duct Size	10" (254) Round
Discharge	Vertical
Internal Blower*	1200 CFM
In-Line Blower*	1100 CFM
Remote Blowers*	900, 1200 or 1500 CFM
Electrical Supply	110/120 V AC, 60 Hz 15 amp circuit
Shipping Weight (shell only)	39-65 lbs (18-29 kg)

OVERALL DIMENSIONS

Pro Hood Liners

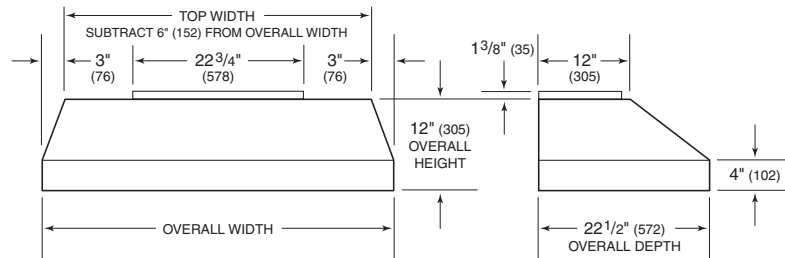

Unit dimensions may vary to ±1/8" (3).

*Blower options vary with the size of hood and cooking surface. Refer to the Pro ventilation recommendations on pages 117-120.

DECORATIVE HOOD

A decorative hood can be created out of wood, plaster, tile or metal. The shape of the decorative hood is not critical. The only place where the liner and outside cover must meet is at the bottom edge of the metal liner. The decorative hood and liner must fit at the bottom edge in both width and depth.

The height of the liner does not have to be the same as the height of the decorative hood and is generally shorter.

The top depth of the liner, which is 12" (305) standard, must be less than the interior depth of the decorative hood. Measure the interior depth of the hood at the top height of the liner to make sure the liner will fit inside the decorative hood.

The hood liner comes standard with a 4" (102) lower reveal. Be sure to include this dimension in your decorative hood selection.

Always use the interior measurements of the decorative hood and measure in multiple places. Use the smallest dimensions to verify hood liner specifications.

Dimensions in parentheses are in millimeters unless otherwise specified.

INSTALLATION SPECIFICATIONS

Pro Hood Liners

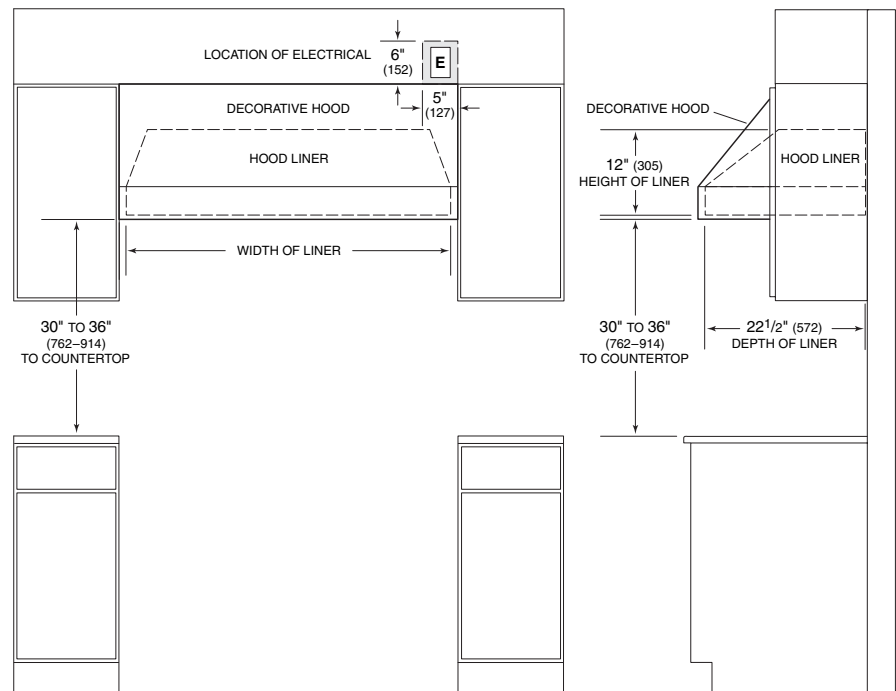



BLOWER CONSIDERATIONS

All Pro ventilation hoods and hood liners are shipped without the blower assembly. Internal, in-line and remote blower assemblies are available. Remote blowers can be mounted on the roof or an exterior wall.

The blower assemblies are quite varied, and depending on the amount of air you want to move and the length of the duct run, you have many options.

A straight, short duct run with a limited number of elbows and transitions will allow the ventilation hood to perform most efficiently. Pro ventilation hoods and hood liners will operate most efficiently when ductwork does not exceed 50' (15 m) in length.

A remote mounted blower will minimize the amount of blower noise, but will not eliminate the noise completely.

IMPORTANT NOTE: Install these ventilation hoods and hood liners only with a Wolf blower.

Refer to the Pro ventilation recommendations on pages 117-120.

Refer to installation instructions shipped with each Wolf product for detailed specifications.

DUCTING CONSIDERATIONS

Pro Low-Profile Wall Hoods

(Refer to the following page for additional ducting considerations.)

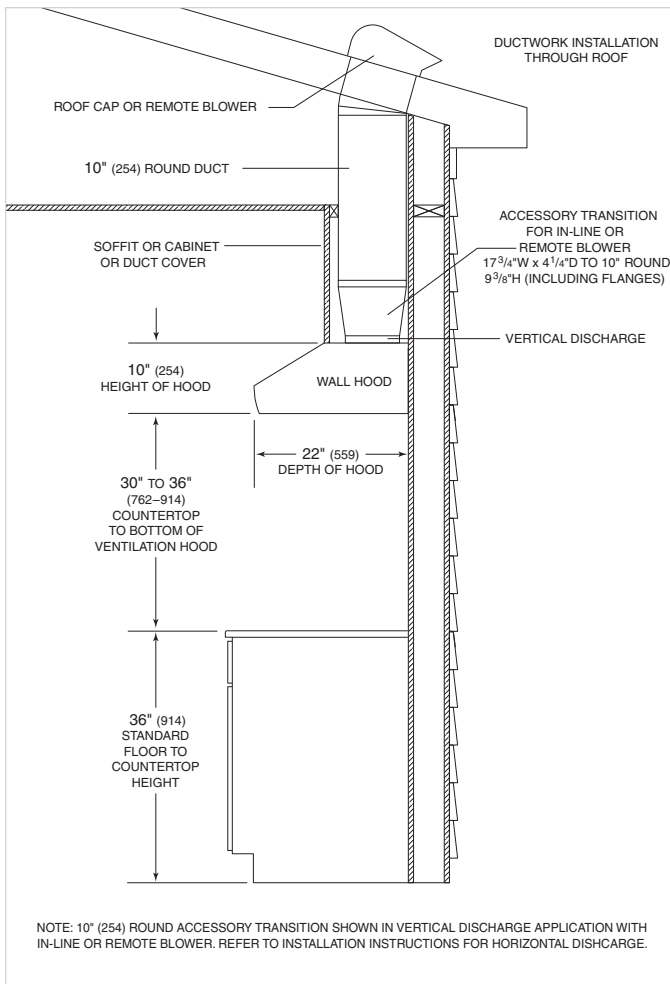

Pro 24" (610) Deep Wall Hoods

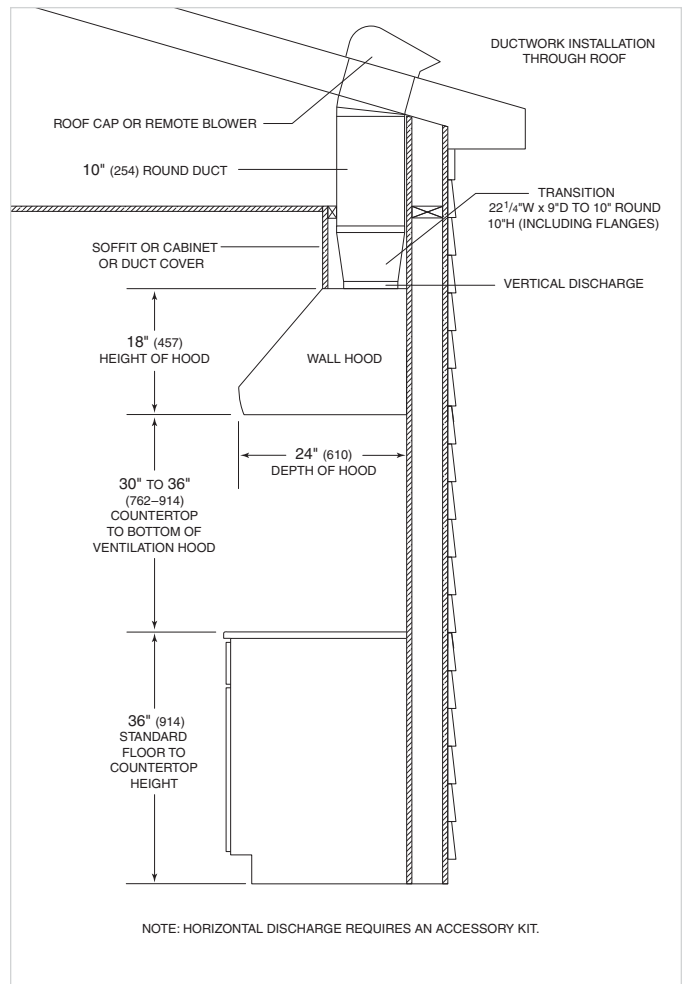

DUCTING CONSIDERATIONS

IMPORTANT NOTE: Unless a recirculating kit is being used, all Wolf Pro ventilation hoods and hood liners must be vented to the outside. Use only metal ductwork.

Wolf Pro low-profile wall hoods come standard from the factory with horizontal or vertical discharge.

IMPORTANT NOTE: When using an in-line or external blower with the low-profile hood, use either the optional accessory 10" (254) round transition or a custom piece. The rectangular cut-out on the hood is 3 1/4" (83) x 14" (356).

IMPORTANT NOTE: Internal blower WBLOWER-50INT comes with a transition for use with 3 1/4" (83) x 10" (254) ducting attached to the blower. A 3 1/4" (83) x 10" (254) to 8" (203) round transition is available as a sales accessory.

Wolf Pro 24" (610) and 27" (686) deep wall hoods have a vertical discharge. A horizontal discharge kit is available as a sales accessory.

In a horizontal discharge application, additional framework may be needed to accommodate the remote blower. Consult your local HVAC professional for specific requirements in this application.

Wolf Pro wall chimney hoods, island hoods and hood liners have a vertical discharge.

Refer to illustrations on the previous page for ducting considerations for the Pro low-profile and Pro 24" (610) deep wall hoods. Refer to illustrations below for the Pro 27" (686) deep wall hoods and Pro wall chimney hoods. Refer to illustrations on the following page for the Pro island hoods and Pro hood liners.

DUCTING CONSIDERATIONS

Pro 27" (686) Deep Wall Hoods

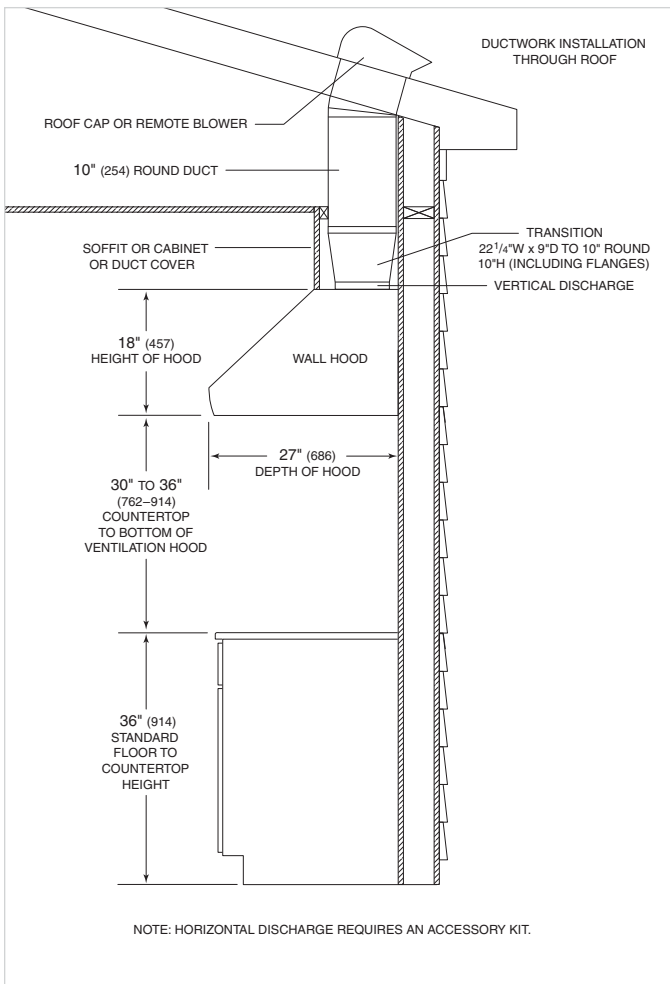

Pro Wall Chimney Hoods

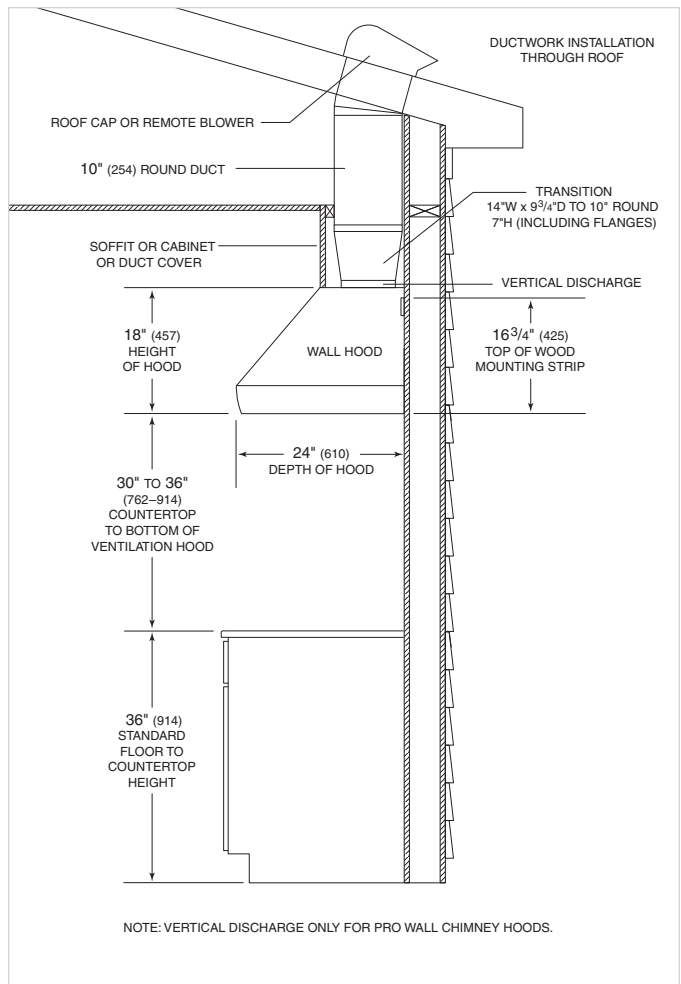



RECIRCULATING KIT

If you are installing the accessory recirculating kit, refer to the instructions included with the kit before installing the hood. Accessory kits are available through your Wolf dealer.

HORIZONTAL DISCHARGE KIT

Horizontal discharge kits are available for Pro 24" (610) and 27" (686) deep wall hoods using a horizontal discharge. Refer to the instructions included in the kit for complete mounting and blower options. Accessory kits are available through your Wolf dealer.

Refer to installation instructions shipped with each Wolf product for detailed specifications.

DUCTING CONSIDERATIONS

Pro Island Hoods

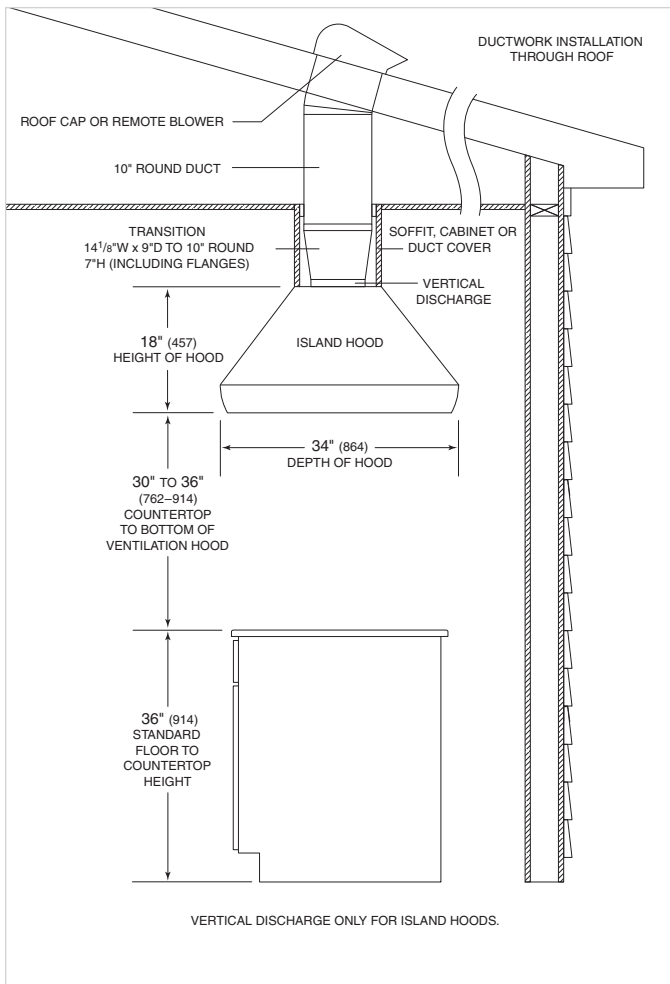

Pro Hood Liners

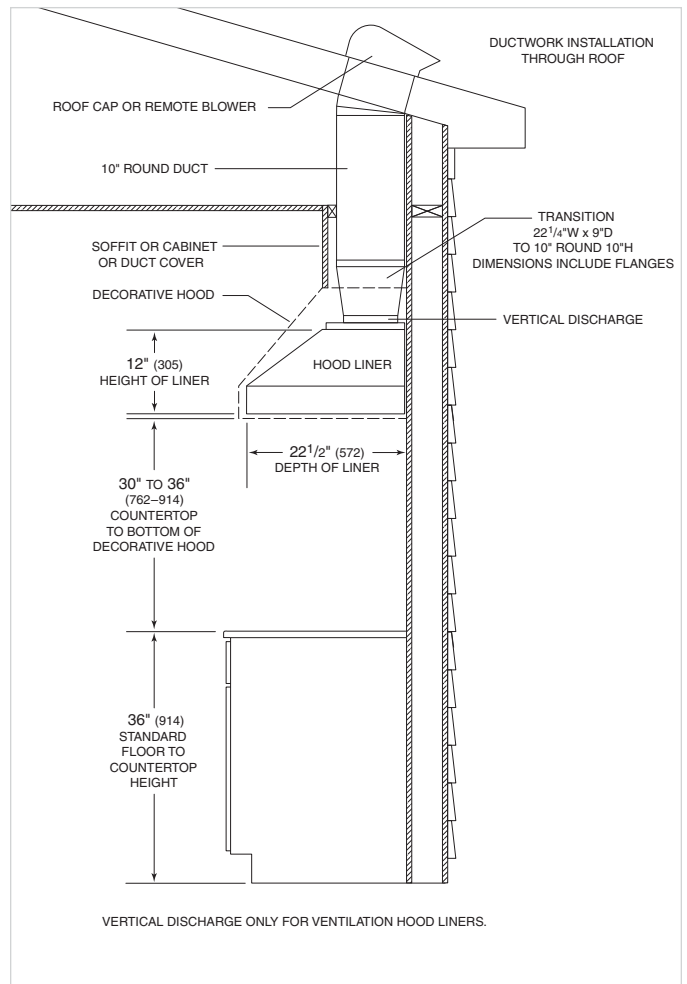



WOLF BLOWER ASSEMBLIES

A ventilation system must include a blower assembly. Wolf ventilation hoods and down-drafts are shipped without the blower assembly. An internal, in-line or remote blower assembly must be selected to accommodate the cooking appliance, CFM requirements and homeowner preferences. Internal, in-line and remote blower assemblies are available as sales accessories through your Wolf dealer.

Remote blowers can be mounted on the roof or, in some cases, on an exterior wall. A remote-mounted blower will minimize the amount of blower noise but will not eliminate the noise completely.

Wolf internal, in-line and remote blowers are for use with Wolf cooktop hoods, downdraft systems and Pro ventilation hoods and hood liners.

Cooktop and Pro ventilation recommendation charts on pages 115-120 provide minimum CFM recommendations according to the cooking appliance and ventilation system used and blower options for each specific ventilation hood or downdraft.

Refer to the illustrations below for dimensions of Wolf in-line and remote blowers. Installation instructions shipped with each Wolf ventilation product provide detailed specifications. These instructions can also be found on our website, wolfappliance.com.

ACCESSORIES

Blower assemblies are available through your Wolf dealer. To obtain local dealer information, visit the Showroom Locator section of our website, wolfappliance.com.

Internal blowers are mounted inside the hood canopy or downdraft blower box.

Wolf in-line blowers are mounted between the hood and the exterior of the home. Ducting runs from the hood and connects to the blower. More ducting is attached to the other side of the blower and runs to the exterior of the home. An in-line blower is a good option for those who do not want the blower mounted inside the hood but cannot, or prefer not to, mount a remote blower on the exterior of the home.

IN-LINE BLOWERS

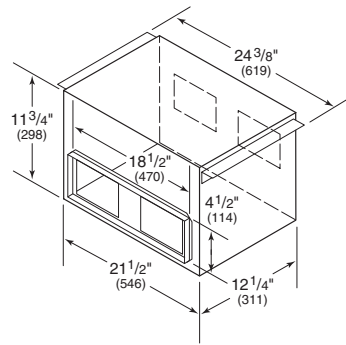

BLOWER-60IL

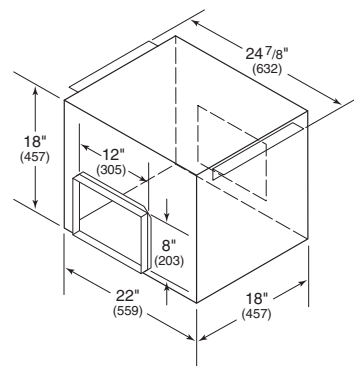

BLOWER-110IL

REMOTE BLOWERS

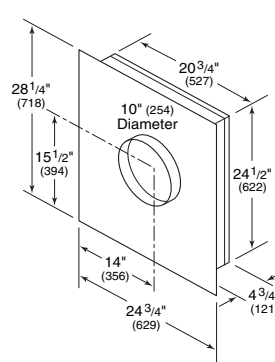

BLOWER-60REM and BLOWER-90REM

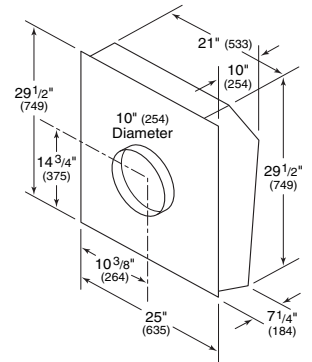

BLOWER-150REM

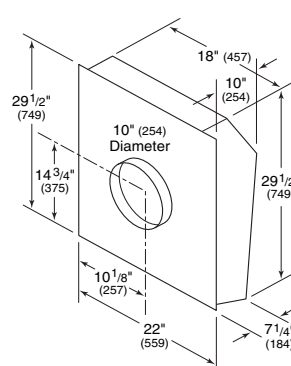

BLOWER-120REM

Dimensions in parentheses are in millimeters unless otherwise specified.



COOKTOP VENTILATION CFM RECOMMENDATIONS

COOKTOP HOODS AND DOWNDRAFTS

	CTWH30	CTWH36	IH4227	DD30	DD36	DD45	Pro Hoods
Induction Cooktops							
Model CT15I	215*	215*	215*	215*		150*	215*
Model CT30I	450	600	600	500		350	600
Model CT36I		600	600		500		600

	CTWH30	CTWH36	IH4227	DD30	DD36	DD45	Pro Hoods
Electric Cooktops							
Model CT15E	215*	215*	215*	215*		150*	215*
Model CT30E	450	600	600	500		350	600
Model CT30EU	450	600	600				600
Model CT36E		600	600		500		600
Model CT36EU		600	600				600

	CTWH30	CTWH36	IH4227	DD30	DD36	DD45	Pro Hoods
Gas Cooktops							
Model CT15G	215*	215*	215*	215*		150*	215*
Model CT30G	450	600	600	500		350	600
Model CT36G		600	600		500		600

	CTWH30	CTWH36	IH4227	DD30	DD36	DD45	Pro Hoods
Integrated Modules							
Model IG15	215*	215*	215*				215*
Model IS15	215*	215*	215*				215*
Model IF15	215*	215*	215*				215*
Model IM15	215*	215*	215*	215*		150*	215*

	CTWH30	CTWH36	IH4227	DD30	DD36	DD45	Pro Hoods
Sealed Burner Rangetops							
Model SRT304				600			600
Model SRT366					900		900

*Use these recommendations to determine total CFM when installing multiple cooktops or modules.

CFM

Recommendations are based on total Btu/hr output. Wolf recommends 1 CFM per 100 Btu/hr (.03 kW). Additional CFM may be required for charbroilers, griddles and long duct runs.

COOKTOP VENTILATION BLOWER OPTIONS

COOKTOP WALL AND ISLAND HOODS

Blower Description	Blower Number	Cooktop Hood Models
450 CFM Internal	CTBLOWER-45INT (801643 – 810313 as of Fall 2007)	CTWH30
600 CFM Internal	CTBLOWER-60INT (801644 – 810314 as of Fall 2007)	CTWH36 / IH4227
900 CFM Internal	CTBLOWER-90INT (801645 – 810315 as of Fall 2007)	CTWH36 / IH4227
600 CFM In-Line	BLOWER-60IL (808331)	CTWH30 / CTWH36 / IH4227
1100 CFM In-Line	BLOWER-110IL (808332)	CTWH30 / CTWH36 / IH4227
600 CFM Remote	BLOWER-60REM (801640)	CTWH30 / CTWH36 / IH4227
900 CFM Remote	BLOWER-90REM (801641)	CTWH30 / CTWH36 / IH4227
1200 CFM Remote	BLOWER-120REM (801642)	CTWH30 / CTWH36 / IH4227
1500 CFM Remote	BLOWER-150REM (804701)	CTWH30 / CTWH36 / IH4227

Vertical discharge with 8" (203) round duct for wall and island hoods. Transition not required for internal blowers; in-line and remote blowers require TRANS-8-10. Backdraft damper included.

DOWNDRAFT SYSTEMS

Blower Description	Blower Number	Downdraft Models
500 CFM Internal	Included with (I) Models	DD30I / DD36I / DD45I
1100 CFM In-Line	BLOWER-110IL (808332)	DD30R / DD36R / DD45R
900 CFM Remote	BLOWER-90REM (801641)	DD30R / DD36R / DD45R
1200 CFM Remote	BLOWER-120REM (801642)	DD30R / DD36R / DD45R
1500 CFM Remote	BLOWER-150REM (804701)	DD30R / DD36R / DD45R

Adjustable discharge. 3 1/4" (83) x 10" (254) duct for internal blower, no transition required. 3 1/4" (83) x 14" (356) duct for in-line and remote blowers. TRANS-14-10 required for remote blowers.

IMPORTANT NOTE

Blower configurations are for reference only. Refer to the minimum CFM recommendations for your specific cooking appliance. Consult a qualified HVAC engineer for specific installation and ducting applications.

Dimensions in parentheses are in millimeters unless otherwise specified.



PRO VENTILATION CFM RECOMMENDATIONS

PRO LOW-PROFILE WALL HOODS

Model	PW302210	PW362210	PW422210	PW482210
DF304 / R304 / SRT304	500/600	500/600		
DF366 / R366 / SRT366 / RT366		900	900	
DF364 / R364 / SRT364 / RT364		900	900	
RT362		900	900	
DF484 / R484 / SRT484 / RT484				900

IMPORTANT NOTE

PRO 24" (610) DEEP WALL HOODS

Model	PW302418	PW362418	PW422418	PW482418	PW542418	PW602418	PW662418
DF304 / R304 / SRT304	600	600					
DF366 / R366 / SRT366 / RT366		900	900				
DF364 / R364 / SRT364 / RT364		900	900				
RT362		900	900				
R488 / RT488				1100	1100		
DF486 / R486 / SRT486 / RT486				1100	1100		
DF484 / R484 / SRT484 / RT484				1100	1100		
DF606 / R606						1500	1500
DF604						1500	1500

For optimal performance in wall hood applications, a Pro 27" (686) deep wall hood is recommended for use with ranges and rangetops that contain a charbroiler or griddle.

CFM

Recommendations are based on total Btu/hr output. Wolf recommends 1 CFM per 100 Btu/hr (.03 kW). Additional CFM may be required for charbroilers, griddles and long duct runs.

PRO 27" (686) DEEP WALL HOODS

Model	PW302718	PW362718	PW422718	PW482718	PW542718	PW602718	PW662718
DF304 / R304 / SRT304	600	600					
DF366 / R366 / SRT366 / RT366		900	900				
DF364 / R364 / SRT364 / RT364		900	900				
RT362		900	900				
R488 / RT488				1100	1100		
DF486 / R486 / SRT486 / RT486				1100	1100		
DF484 / R484 / SRT484 / RT484				1100	1100		
DF606 / R606						1500	1500
DF604						1500	1500

MODEL NUMBERS

Model numbers for dual fuel ranges, gas ranges, sealed burner rangetops and gas rangetops indicate width and number of surface burners. Features such as a charbroiler, griddle and/or French Top will vary.



PRO VENTILATION CFM RECOMMENDATIONS

PRO WALL CHIMNEY HOODS

Model	PWC362418	PWC422418	PWC482418	PWC542418
DF304 / R304 / SRT304	600	600		
DF366 / R366 / SRT366 / RT366	900	900		
DF364 / R364 / SRT364 / RT364	900	900		
RT362	900	900		
R488 / RT488			1100	1100
DF486 / R486 / SRT486 / RT486			1100	1100
DF484 / R484 / SRT484 / RT484			1100	1100

CFM

Recommendations are based on total Btu/hr output. Wolf recommends 1 CFM per 100 Btu/hr (.03 kW). Additional CFM may be required for charbroilers, griddles and long duct runs.

PRO ISLAND HOODS

Model	PI363418	PI423418	PI543418	PI663418
DF304 / R304 / SRT304	600	600		
DF366 / R366 / SRT366 / RT366		900		
DF364 / R364 / SRT364 / RT364		900		
RT362		900		
R488 / RT488			1100	
DF486 / R486 / SRT486 / RT486			1100	
DF484 / R484 / SRT484 / RT484			900	
DF606 / R606				1500
DF604				1500

MODEL NUMBERS

Model numbers for dual fuel ranges, gas ranges, sealed burner rangetops and gas rangetops indicate width and number of surface burners. Features such as a charbroiler, griddle and/or French Top will vary.

PRO HOOD LINERS

Model	PL342212	PL402212	PL462212	PL522212	PL582212
DF304 / R304 / SRT304	600	600			
DF366 / R366 / SRT366 / RT366	900	900			
DF364 / R364 / SRT364 / RT364	900	900			
RT362	900	900			
R488 / RT488			1100	1100	
DF486 / R486 / SRT486 / RT486			1100	1100	
DF484 / R484 / SRT484 / RT484			900	900	
DF606 / R606					1500
DF604					1500

Dimensions in parentheses are in millimeters unless otherwise specified.



PRO VENTILATION BLOWER OPTIONS

PRO LOW-PROFILE WALL HOODS

Blower Description	Blower Number	Wall Hood Models
500 CFM Internal	WBLOWER-50INT (810991)	All Low-Profile Wall Hoods
600 CFM In-Line	BLOWER-60IL (808331)	All Low-Profile Wall Hoods
600 CFM Remote	BLOWER-60REM (801640)	All Low-Profile Wall Hoods
900 CFM Remote	BLOWER-90REM (801641)	All Low-Profile Wall Hoods

IMPORTANT NOTE

PRO 24" (610) DEEP WALL HOODS

Blower Description	Blower Number	Wall Hood Models
600 CFM Internal	WBLOWER-60INT (810559)	PW302418 / PW362418 / PW422418
900 CFM Internal	WBLOWER-90INT (811131)	PW302418 / PW362418 / PW422418
1200 CFM Internal	WBLOWER-120INT (810316)	PW482418 / PW542418 / PW602418 / PW662418
600 CFM In-Line	BLOWER-60IL (808331)	PW302418
1100 CFM In-Line	BLOWER-110IL (808332)	All 24" (610) Deep Wall Hoods
600 CFM Remote	BLOWER-60REM (801640)	PW302418
900 CFM Remote	BLOWER-90REM (801641)	PW302418 / PW362418 / PW422418 / PW482418 / PW542418
1200 CFM Remote	BLOWER-120REM (801642)	All 24" (610) Deep Wall Hoods
1500 CFM Remote	BLOWER-150REM (804701)	All 24" (610) Deep Wall Hoods

For optimal performance in wall hood applications, a Pro 27" (686) deep wall hood is recommended for use with ranges and rangetops that contain a charbroiler or griddle.

Blower configurations are for reference only. Refer to the minimum CFM recommendations for your specific cooking appliance. Consult a qualified HVAC engineer for specific installation and ducting applications.

PRO 27" (686) DEEP WALL HOODS

Blower Description	Blower Number	Wall Hood Models
600 CFM Internal	WBLOWER-60INT (810559)	PW302718 / PW362718 / PW422718
900 CFM Internal	WBLOWER-90INT (811131)	PW302718 / PW362718 / PW422718
1200 CFM Internal	WBLOWER-120INT (810316)	PW482718 / PW542718 / PW602718 / PW662718
600 CFM In-Line	BLOWER-60IL (808331)	PW302718
1100 CFM In-Line	BLOWER-110IL (808332)	All 27" (686) Deep Wall Hoods
600 CFM Remote	BLOWER-60REM (801640)	PW302718
900 CFM Remote	BLOWER-90REM (801641)	PW302718 / PW362718 / PW422718 / PW482718 / PW542718
1200 CFM Remote	BLOWER-120REM (801642)	All 27" (686) Deep Wall Hoods
1500 CFM Remote	BLOWER-150REM (804701)	All 27" (686) Deep Wall Hoods

Wall hood models without decorative rail listed; blower options are the same for (R) models.

Transition with backdraft damper included with all 24" (610) and 27" (686) deep wall hoods.



PRO VENTILATION BLOWER OPTIONS

PRO WALL CHIMNEY HOODS

Blower Description	Blower Number	Wall Chimney Hood Models
600 CFM Internal	CTBLOWER-60INT (801644 – 810314 as of Fall 2007)	PWC362418 / PWC422418
900 CFM Internal	CTBLOWER-90INT (801645 – 810315 as of Fall 2007)	PWC362418 / PWC422418
1200 CFM Internal	IBLOWER-120INT (804703 – 810317 as of Fall 2007)	PWC482418 / PWC542418
1100 CFM In-Line	BLOWER-110IL (808332)	All Pro Wall Chimney Hoods
900 CFM Remote	BLOWER-90REM (801641)	All Pro Wall Chimney Hoods
1200 CFM Remote	BLOWER-120REM (801642)	All Pro Wall Chimney Hoods
1500 CFM Remote	BLOWER-150REM (804701)	All Pro Wall Chimney Hoods

IMPORTANT NOTE

For optimal performance in wall hood applications, a Pro 27" (686) deep wall hood is recommended for use with ranges and rangetops that contain a charbroiler or griddle.

Blower configurations are for reference only. Refer to the minimum CFM recommendations for your specific cooking appliance. Consult a qualified HVAC engineer for specific installation and ducting applications.

Wall chimney and island hood models without decorative rails listed; blower options are the same for (R) models.

Transition with backdraft damper included with all wall chimney hoods, island hoods and hood liners.

PRO ISLAND HOODS

Blower Description	Blower Number	Island Hood Models
1200 CFM Internal	IBLOWER-120INT (804703 – 810317 as of Fall 2007)	All Island Hoods
1100 CFM In-Line	BLOWER-110IL (808332)	All Island Hoods
900 CFM Remote	BLOWER-90REM (801641)	PI363418 / PI423418 / PI543418
1200 CFM Remote	BLOWER-120REM (801642)	All Island Hoods
1500 CFM Remote	BLOWER-150REM (804701)	All Island Hoods

PRO HOOD LINERS

Blower Description	Blower Number	Hood Liner Models
1200 CFM Internal	LBLOWER-120INT (805087)	All Hood Liners
1100 CFM In-Line	BLOWER-110IL (808332)	All Hood Liners
900 CFM Remote	BLOWER-90REM (801641)	All Hood Liners
1200 CFM Remote	BLOWER-120REM (801642)	All Hood Liners
1500 CFM Remote	BLOWER-150REM (804701)	All Hood Liners

Dimensions in parentheses are in millimeters unless otherwise specified.

WOLF APPLIANCE PRODUCTS LIMITED WARRANTY

RESIDENTIAL USE ONLY

FULL TWO YEAR WARRANTY*

For two years from the date of original installation, your Wolf Appliance product warranty covers all parts and labor to repair or replace any part of the product that proves to be defective in materials or workmanship. All service provided by Wolf Appliance under the above warranty must be performed by a Wolf Appliance authorized service center, unless otherwise specified by Wolf Appliance. Service will be provided in the home during normal business hours.

LIMITED THIRD THROUGH FIFTH YEAR WARRANTY

From the third through fifth year from the date of original installation, Wolf Appliance will repair or replace the following parts that prove to be defective in materials or workmanship. Labor to remove and replace defective parts is not covered. Wolf Appliance recommends that you use a Wolf Appliance authorized service center to perform such service.

Gas Burners (excluding appearance), Electric Heating Elements, Blower Motors (vent hoods),
Electronic Control Boards, Magnetron Tubes and Induction Generators

LIMITED LIFETIME WARRANTY

For the life of the product, Wolf Appliance will repair or replace any outdoor gas grill body or hood that rusts through due to defective material or workmanship. Labor to remove and replace defective parts is not covered. Wolf Appliance recommends that you use a Wolf Appliance authorized service center to perform such service.

TERMS APPLICABLE TO EACH WARRANTY

The warranty applies only to products installed for normal residential use. The warranty applies only to products installed in any one of the fifty states of the United States, the District of Columbia or the ten provinces of Canada. This warranty does not cover any parts or labor to correct any defect caused by negligence, accident or improper use, maintenance, installation, service or repair.

THE REMEDIES DESCRIBED ABOVE FOR EACH WARRANTY ARE THE ONLY ONES THAT WOLF APPLIANCE, INC. WILL PROVIDE, EITHER UNDER THIS WARRANTY OR UNDER ANY WARRANTY ARISING BY OPERATION OF LAW. WOLF APPLIANCE, INC. WILL NOT BE RESPONSIBLE FOR ANY CONSEQUENTIAL OR INCIDENTAL DAMAGES ARISING FROM THE BREACH OF THIS WARRANTY OR ANY OTHER WARRANTY, WHETHER EXPRESS, IMPLIED OR STATUTORY.

Some states do not allow the exclusion or limitation of incidental or consequential damages, so the above limitation or exclusion may not apply to you. This warranty gives you specific legal rights and you may also have other legal rights that vary from state to state.

To receive parts and/or service and the name of the Wolf Appliance authorized service center nearest you, contact Wolf Appliance, Inc., P.O. Box 44848, Madison, Wisconsin 53744; check the Constant Care section of our website, wolfappliance.com, or call 800-332-9513.

*Stainless Steel (classic, platinum and carbon) doors, panels and product frames are covered by a limited 60 day parts and labor warranty for cosmetic defects.



WOLF APPLIANCE OUTDOOR PRODUCTS LIMITED WARRANTY

RESIDENTIAL USE ONLY

FULL ONE YEAR WARRANTY*

For one year from the date of original installation, your Wolf Appliance product warranty covers all parts and labor to repair or replace any part of the product that proves to be defective in materials or workmanship. All service provided by Wolf Appliance under the above warranty must be performed by a Wolf Appliance authorized service center, unless otherwise specified by Wolf Appliance. Service will be provided in the home during normal business hours.

LIMITED LIFETIME WARRANTY

For the life of the product, Wolf Appliance will repair or replace any outdoor gas grill body or hood that rusts through due to defective material or workmanship. Labor to remove and replace defective parts is not covered. Wolf Appliance recommends that you use a Wolf Appliance authorized service center to perform such service.

TERMS APPLICABLE TO EACH WARRANTY

The warranty applies only to products installed for normal residential use. The warranty applies only to products installed in any one of the fifty states of the United States, the District of Columbia or the ten provinces of Canada. This warranty does not cover any parts or labor to correct any defect caused by negligence, accident or improper use, maintenance, installation, service or repair.

THE REMEDIES DESCRIBED ABOVE FOR EACH WARRANTY ARE THE ONLY ONES THAT WOLF APPLIANCE, INC. WILL PROVIDE, EITHER UNDER THIS WARRANTY OR UNDER ANY WARRANTY ARISING BY OPERATION OF LAW. WOLF APPLIANCE, INC. WILL NOT BE RESPONSIBLE FOR ANY CONSEQUENTIAL OR INCIDENTAL DAMAGES ARISING FROM THE BREACH OF THIS WARRANTY OR ANY OTHER WARRANTY, WHETHER EXPRESS, IMPLIED OR STATUTORY.

Some states do not allow the exclusion or limitation of incidental or consequential damages, so the above limitation or exclusion may not apply to you. This warranty gives you specific legal rights and you may also have other legal rights that vary from state to state.

To receive parts and/or service and the name of the Wolf Appliance authorized service center nearest you, contact Wolf Appliance, Inc., P.O. Box 44848, Madison, Wisconsin 53744; check the Constant Care section of our website, wolfappliance.com, or call 800-332-9513.

*Stainless Steel (classic, platinum and carbon) doors, panels and product frames are covered by a limited 60 day parts and labor warranty for cosmetic defects.



The information and images in this guide are the copyright property of Wolf Appliance, Inc., an affiliate of Sub-Zero, Inc. Neither this book nor any information or images contained herein may be copied or used in whole or in part without the express written permission of Wolf Appliance, Inc., an affiliate of Sub-Zero, Inc.

©Wolf Appliance, Inc. all rights reserved.



WOLF APPLIANCE, INC. P. O. BOX 44848 MADISON, WI 53744 800.332.9513 WOLFAPPLIANCE.COM