

# Operating Instructions

## Washing Machine

Save these instructions for future reference

*Dear ASKO Customer,*

*Thank you for choosing this quality product from Scandinavia, which was made in Sweden.*

*We want you to feel assured that the inside of your new machine is just as good as the outside and that the ethics and standards that went into the production of this machine are just as high as the quality and performance that you will receive from it. We hope that this product will give you many years of pleasure.*

*To ensure that you get the most out of your new machine, we recommend that you read the operating instructions before using the machine. The operating instructions also contain information on how to avoid damaging the environment.*

**ASKO W6863**

 **ASKO**

# Contents

<b>Before using your machine for the first time</b>	4	<b>Advice and tips before washing</b>	11
Transport protection	4	Sorting your laundry	11
Packing material	4	Clothing	11
Washer door	4	Laundry labels	11
Checking water hardness	4	Laundry label symbols	11
<b>Important safety instructions</b>	5	Colored cotton	13
Grounding instructions	5	Delicates	13
Installation	6	Wool and silk	13
Overflow guard function	6	Artificial fibers and synthetic fibers	13
Transport/Winter storage	6	Reducing allergic reactions	13
Disposal	6	Save time and energy	13
<b>Child safety</b>	7	High Water Level	13
Keep an eye on children!	7	Economy and efficiency	13
Activating/deactivating Child-safe Start	7	Backlighting	13
<b>Parts of the washing machine</b>	8	Detergents	14
<b>Detergent compartment</b>	9	Dyeing fabrics	14
<b>Front panel</b>	10	Liquid detergents	14
		Detergents	14
		Recommended powder detergents	15
		Detergent Amounts Based on Water Hardness	15
		Amount of detergent to use	16
		Recommended detergent amounts based on water hardness	16
		<b>Operating instructions</b>	17
		Sort your laundry.	17
		Turn on the main power switch.	17
		Open the washer door and load the laundry	17
		Add detergent and fabric softener, as required	17
		Select the program	19
		Close the door and press the Start/Stop button	22
		Once the program has finished	22

# Contents

<b>Selecting Options</b>	23	<b>Installation instructions</b>	32
Temperature	23	Leveling the machine	32
Spin	23	Water supply connection	32
Delayed Start	23	Drain outlet connection	33
Super Rinse	23	Electrical Connections	33
High Water Level	24	Grounding instructions	33
Anti Wrinkle function	24	Freestanding installation	33
Super Wash	24	Stacked installation	33
Pre-soak	24	Built-in installation	34
<b>Settings</b>	25	<b>Reversing the door</b>	35
You can change the following settings:	25	Follow these instructions:	36
Child-safe Start	25	<b>Service and guarantee</b>	37
Automatic Door Opening	25	Warranty	38
Select language	25	How to contact the ASKO Appliances Inc.	38
<b>Care and maintenance instructions</b>	26	<b>Quick guide</b>	40
Checking the filter and drain pump	26	Washing	40
Cleaning the detergent compartment	26	Load the laundry	40
Cleaning the outside of the machine	26	Detergent compartment	40
Cleaning the inside of the machine to avoid unpleasant smells	26	Select the program	40
Rinse holes under the paddle	27	Program finished	40
If you have hard water	27		
<b>Troubleshooting</b>	28		
The washer door will not open	28		
The machine will not start	28		
Error messages	29		
<b>Technical information</b>	30		
Technical data	30		
<b>Transport protection</b>	31		

# Before using your machine for the first time

Do you need this Use&Care Guide in spanish? Log onto [www.askousa.com/customer-care](http://www.askousa.com/customer-care) to download.

¿Necesita esta Instrucciones de uso y cuidado en español? Entre en [www.askousa.com/customer-care](http://www.askousa.com/customer-care) y descárguela.

## Transport protection

Has the transport protection been removed? If not, see the "Transport protection" chapter.

## Packing material

Please sort waste materials in accordance with local guidelines.

## Washer door

- The washer door cannot be opened until the machine is connected to the electricity supply.
- To open the door manually, see the "The door will not open" section in the "Troubleshooting" chapter.
- It is not possible to start the machine with the door open.
- To open the washer door while a program is running, see the "Close the door and press the Start/Stop button" section.

## Checking water hardness

The quantity of detergent needed depends, among other things, on water hardness. Phone your local water company to check the water hardness in your area.

### Note!

Each machine is tested before leaving the factory. A small amount of water may remain in the drain pump, though this does not affect quality or damage the machine.

**See the Quick guide on the last page.**

# Important safety instructions



## Save these instructions for future reference

**WARNING** - To reduce the risk of fire, electric shock, or injury to persons when using your appliance, follow basic precautions, including the following:

- Read all instructions before using the appliance.
- Do not run appliance while you are out of the home.
- Do not wash or dry articles that have been previously cleaned in, washed in, soaked in, or spotted with gasoline, dry-cleaning solvents, cooking oils, or other flammable or explosive substances because they give off vapors that could ignite or explode.
- Do not allow children to play on or in the appliance. Close supervision of children is necessary when the appliance is used near children.
- Before the appliance is removed from service or discarded, remove the door to the washing compartment.
- Do not reach into the appliance if the drum is moving.
- Do not install or store this appliance where it will be exposed to the weather.
- Do not tamper with controls.
- Do not repair or replace any part of the appliance or attempt any servicing unless specifically recommended in the user-repair instructions or in published user-repair instructions that you understand and have the skills to carry out.
- Do not add gasoline, dry-cleaning solvents, or other flammable or explosive substances to the wash water. These substances give off vapors that could ignite or explode.
- Under certain conditions, hydrogen gas may be produced in a hot water system that has not been used for 2 weeks or more. **HYDROGEN GAS IS EXPLOSIVE.** If the hot water system has not been used

for such a period, before using a washing machine or combination washer-dryer, turn on all water faucets and let the water flow from each for several minutes. This will release any accumulated hydrogen gas. As the gas is flammable, do not smoke or use an open flame during this time.

## Warning!



This appliance must be properly grounded. This manual does not cover every possible condition and situation that may occur. Use common sense and caution when installing, operating, and maintaining any appliance.

## Grounding instructions

### A) Grounding instructions for a grounded, cord-connected appliance:

In the event of malfunction or breakdown, grounding will reduce the risk of electric shock by providing a path of least resistance for electric current. This appliance is equipped with a cord having an equipment-grounding conductor and a grounding plug. The plug must be plugged into an appropriate outlet that is properly installed and grounded in accordance with all local codes and ordinances.

## Warning!



Improper connection of the equipment-grounding conductor can result in a risk of electric shock. Check with a qualified electrician or service representative or personnel if you are in doubt as to whether the appliance is properly grounded.

Do not modify the plug provided with the appliance. If it will not fit the outlet, have a proper outlet installed by a qualified electrician.

# Important safety instructions



## **B) Grounding instructions for a permanently connected appliance:**

This appliance must be connected to a grounded metal, permanent wiring system, or an equipment-grounding conductor must be run with the circuit conductors and connected to the equipment-grounding terminal or lead on the appliance.

### **Note**

This manual does not cover every possible condition and situation that may occur. Use common sense and caution when installing, operating, and maintaining any appliance.

## **Installation**

See the "Installation" chapter.

## **Overflow guard function**

If the machine's water level rises above the normal level, the overflow guard function begins to pump water out and shuts off the water intake. If the water level has not dropped within 60 seconds, the program is terminated.

## **Transport/Winter storage**

If the machine is to be transported or stored in unheated premises where the temperature can fall below freezing, do as follows:

- Empty the filter and drain pump (see the "Care and Cleaning" chapter).
- Shut off the water to the washing machine, loosen the supply hose to the intake valve, and let the water run out from the valve and hose.
- After emptying the pump, a small amount of water may remain in the machine. This does not affect quality or damage the machine.

## **Disposal**

When the machine has reached the end of its service life and is to be disposed of, it should immediately be made unusable by removing the door to the washing compartment. Contact your local authorities for information about where your machine should be disposed of and recycled in the proper way. The machine is manufactured and labeled for recycling.

**Save these instructions for future reference**

# Child safety

## Keep an eye on children!

Watch out for children!

- Laundry detergents are corrosive, so always keep them out of reach of children.
- Should a child swallow detergent, give plenty to drink immediately, i.e., one or two glasses of milk or water. Do not try to induce vomiting. Seek medical advice immediately: The National Poison center phone number is 1-800-222-1222.
- Always close the door and start the appliance as soon as you put in the detergent.
- Always turn the power off to the machine when it is not in use.
- Always keep small children away from the machine when it is open. There may be some detergent residue left inside the machine.
- If laundry detergent gets in someone's eyes, rinse them with plenty of water for at least 15 minutes.

## Activating/deactivating Child-safe Start

- Turn off the machine using the main power switch.
- Press and hold the + on the Time button and the Super Rinse button and turn on the main power switch.
- Turn the program selector and choose "Child-safe Start Off" or "Child-safe Start On".
- Press the Start/Stop button to store.

You can deactivate Child-safe Start by pressing the Super Rinse and Start/Stop buttons at the same time:

The Child-safe Start option will be temporarily deactivated for three minutes.

# Parts of the washing machine

1. Main power switch
2. Detergent compartment
3. Program panel
4. Type plate (on the inside of the glass door)
5. Hatch for drain pump
6. Drain pump (behind hatch)
7. Emergency opening tool (in enclosed plastic bag)
8. Washer door





# Detergent compartment

1. Pre Wash
2. Main Wash
3. Main wash liquid detergent.
4. Fabric softener

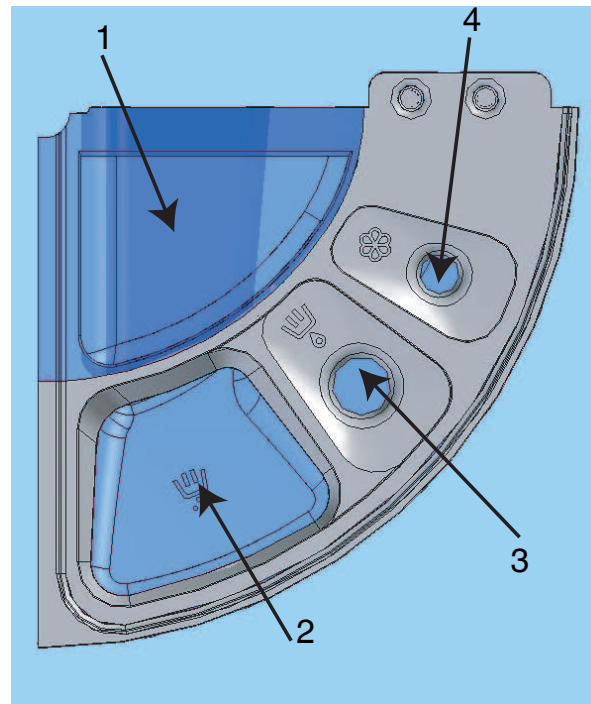

The detergent drawer automatically dispenses the detergent and fabric softener at the appropriate times. Simply pour the measured amounts of detergent and softener into the proper compartments (as illustrated) and close the drawer.

## Note

To avoid oversudsing, do not put detergent in the prewash compartment unless you are using one of the Heavy wash programs which has a prewash cycle.

# Front panel

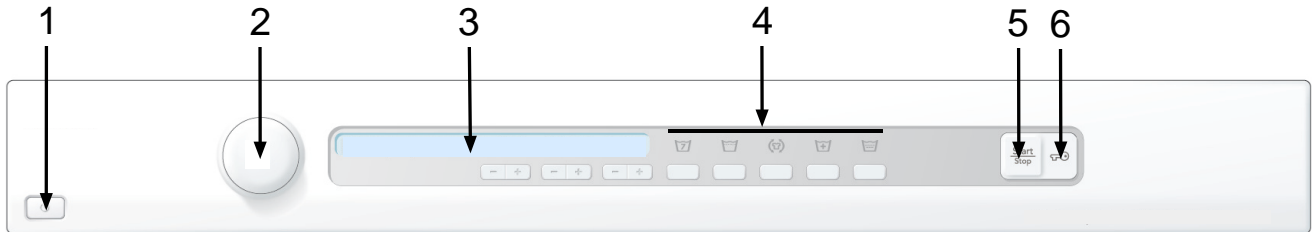

- 1 Main power switch
- 2 Program selector
- 3 Display window

- 4 Options buttons
- 5 Start/Stop
- 6 Door opening

# Advice and tips before washing

Here are some tips that may help you before washing.

## Sorting your laundry

Sort items according to:

- how soiled they are
- color
- material

## Clothing



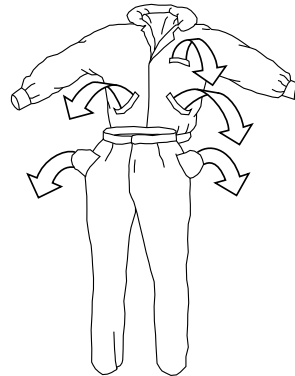



- Close zippers so that they don't harm fabrics.
- New colored items may contain excess dye and should therefore be washed separately the first few times.
- Turn delicate items inside out. This reduces the risk of burling and fading.
- Empty pockets and wash them inside out if possible!



## Laundry labels







Look at the item's laundry label. The table below shows suitable wash programs for different materials and wash loads. Using modern washing machines and detergents, such as compact detergents, you can usually wash at lower temperatures. It is a good idea to use trial and error to find out what produces the best results.

## Laundry label symbols







Laundry labels	Material	Program	Load
	Cotton, linen, white, and light-colored items.	Stain 140°F (60°C) to 203°F (95°C)	1/1 drum
	Cotton, linen. Dark-colored items.	Color 140°F (60°C)	1/1 drum
	Polyester, cotton/polyester, nylon. White items.	PermaPress 140°F (60°C)	1/2 drum
	Rayon, acetate, acrylic. Non-colorfast items.	PermaPress 104°F (40°C)	1/2 drum
	Polyester, cotton/polyester, nylon. Colored items.	PermaPress 104°F (40°C)	1/2 drum
	Silk and very delicate items	PermaPress 86°F (30°C)	1/3 drum
	Items labeled with the IWS or Superwash mark	Wool/Delicate / Hand 104°F (40°C)	1/3 drum

# Advice and tips before washing



## Wash cycle

-  Normal wash cycle
-  Permanent Press or Wrinkle Resistant setting
-  Gentle/Delicate setting
-  Hand wash only
-  Do not wash
-  Do not wring. Hang dry, drip dry, or dry flat

## Wash water temperature

-  Maximum water temp 200° F/95° C
-  Maximum water temp 160° F/70° C
-  Maximum water temp 140° F/60° C
-  Maximum water temp 120° F/50° C
-  Maximum water temp 105° F/40° C
-  Maximum water temp 85° F/30° C





## Bleach instructions

-  Any bleach when needed
-  Only non-chlorine bleach
-  Do not bleach





## Dry clean symbol

-  Dry clean only





## Tumble dry cycle

-  Machine dry
-  Normal setting
-  Permanent Press or Wrinkle Resistant setting
-  Gentle or Delicate setting
-  Do not tumble dry







## Tumble dry heat setting

-  Any heat
-  High heat
-  Medium heat
-  Low heat
-  No heat/Air fluff

## Special drying instructions

-  Line dry or hang to dry
-  Drip dry (do not spin or wring)
-  Dry flat
-  Dry in shade

## Ironing instructions

-  Ironing is necessary
-  High temperature setting
-  Medium temperature setting
-  Low temperature setting
-  Do not iron or press with heat
-  Iron without steam

# Advice and tips before washing

## Colored cotton

Colored cotton items labeled 140°F (60°C) should be washed at 140°F (60°C) the first time in order to remove any excess dye. If you do not do so, there is a risk that the color will run. Use detergent without bleach in order to preserve the color of the fabric.

## Delicates

### Unbleached linen

Unbleached linen fabrics should be washed at 140°F (60°C), using detergent containing no bleach or optical whiteners. Heavily-soiled linen can occasionally be washed at higher temperatures, but not too often as the heat can destroy the linen's sheen and strength.

## Wool and silk

These fabrics are sometimes labeled as machine washable and sometimes as hand wash. The machine's Wool/hand program is just as gentle as washing by hand.

Wool is especially sensitive to processes such as washing.

If you do not wish to spin dry, you can squeeze out the water using terrycloth towels. In this case select No spin.

To find out how to select this setting, see the Washing chapter. However, most garments can withstand a short spin. Choose a short spin by selecting a spin speed of 800 rpm or less.

## Artificial fibers and synthetic fibers

These materials require plenty of room to prevent them from getting wrinkled. Only fill half the drum when washing artificial or synthetic fibers. Choose a short spin by selecting a spin speed of 800 rpm or less.

### Note!

Viscose and acetates are fragile when wet.

## Reducing allergic reactions

The washing machine has a Super Rinse option. Use this for people with sensitive skin, such as those with allergies and small children.

## Save time and energy

Use the White program to save time and energy. This program has a shorter main wash than Normal, but is often sufficient for lightly soiled laundry.

## High Water Level

If you want more water for the main wash and rinses, you can use the High Water Level option. High Water Level is used automatically in the Wool/Hand program.

## Economy and efficiency

You can save a lot of energy by not using higher temperature programs than necessary.

- Select Quick if you just need to freshen up shirts or exercise clothes, for example. This will save both water and energy.
- If you select a fast spin speed, this reduces energy consumption when drying in a tumble dryer or drying cabinet.
- Always wash with a full load when using the Sani, Stain, Color, and White programs!
- Avoid washing with pre-wash. Modern machines and detergents clean without pre-wash. Only very heavily soiled laundry, such as overalls and similar garments, are likely to need a pre-wash.

## Backlighting

Two minutes after the wash program finishes the display backlighting enters energy saving mode.

# Advice and tips before washing

## Detergents

Eco-labeled detergents are less harmful to the environment.

Detergent overdosing does not give better washing results; it merely causes a greater impact on the environment.

Try to use less detergent, and increase only if you are not satisfied with the results.

## Dyeing fabrics

If you want to dye fabrics in the machine, select the Normal program with the Super Rinse option On. Select temperature according to the dye manufacturer's recommendations.

Choose a low spin speed if the fabric to be dyed is a blended material such as polyester/cotton.

### Note!

Add the dye directly to the washing drum – not to the detergent compartment. After dyeing, you should run the machine empty using the same program. Use the normal amount of detergent.

### Note!

Due to environmental concerns, we discourage the use of strong chemicals.

When using agents for bleaching or stain removal, there is a risk of rust (corrosion) and discoloration of the machine.

## Liquid detergents

We don't recommend liquid detergents because they tend to produce more suds than powder detergents when used in water temperatures of 150° F or higher. If you should try a liquid detergent, start with a very small amount, such as 1 to 2 tablespoons. Also, liquid detergent can be used for all programs without prewash, so add it into the main wash compartment.

## Detergents

Laundry detergents are available in low-, normal- and high-sudsing formulas. A detergent's ability to clean is not relative to the amount of suds it produces. Excess suds in a front-loading washer actually interfere with the cleaning because they cushion the tumbling action. Also, high-sudsing detergents are more difficult to completely rinse out. The use of anything other than a low-sudsing detergent can cause severe oversudsing, which could cause suds to backup through the detergent compartment and run down the front of the washer onto the floor. If oversudsing occurs, run the wash through one or more rinse programs until all items are thoroughly rinsed. Remove the laundry then run the washer through a Normal wash program to get rid of any remaining detergent. We recommend that you don't use bleach in your ASKO washer. The tumbling wash action, temperature control options, extended wash times and proper amount of detergent are sufficient to remove most stains.

# Advice and tips before washing

## Recommended powder detergents

ASKO washers use 50% to 75% less detergent than most other washers. This is because of their low water consumption and the fact that all the wash water is repeatedly circulated through the laundry, ensuring that all the detergent is fully utilized. We recommend that you use powder detergents made specifically for front-loading washers. These are sometimes called HE (High-Efficiency) detergents. Listed below are some low-sudsing powder detergents that have been successfully tested in ASKO washers:

- Fab
- All
- Tide HE
- Amway SA8
- Fresh Start
- Wisk HE

We recommend that you do not use any powder detergent that doesn't wash completely out of the detergent drawer.

## Detergent Amounts Based on Water Hardness

The amount of detergent needed can vary due to differences in water hardness. To determine the water hardness in your area, contact your local water utility or area water softening company. The harder the water, the more detergent you may need. Refer to the chart below for the recommended detergent amounts based on water hardness. Remember, you should adjust the amount of detergent you use by small amounts until you find the correct amount. Note that 12 grains and higher is extremely hard water and detergent alone may not be enough. You may need to use a water softener to maximize the performance of your washer. Also, in areas with extremely hard water (9+) you may need to wash at lower temperatures to prevent hard water deposits from forming in the tank and wash system. Different brands of detergent have different amounts of phosphorous for softening water. If you have hard water and use a detergent with less than 8.7% phosphorous content, you may need to use more detergent or use a detergent with a higher phosphorous content.

# Advice and tips before washing

## Amount of detergent to use

The amount of detergent needed varies among the different brands, but for most detergents, you need only one or two tablespoons. Using too much detergent can result in detergent residue being left in your clothes, which can cause them to appear gray or dingy. You should start with a small amount of detergent and increase it only if the cleaning results are unsatisfactory. Additionally, you should never put detergent in the prewash compartment unless you are using a wash program that has a prewash cycle. This could cause excess foaming, which could damage the machine. The amount of detergent needed can also depend on the hardness of the water in your area. See the “Detergent Amounts Based on Water Hardness” section on the next page for more details.

## Recommended detergent amounts based on water hardness

Water hardness	Detergent amounts	
	Pre Wash	Main Wash
Soft (0-3 grains per gal.)	1 teaspoon	1 to 1-1/2 tablespoons
Medium (4-8 grains per gal.)	1 teaspoon	1 to 2 tablespoons
Hard (9+ grains per gal.)	1 teaspoon	2 to 3 tablespoons



# Operating instructions

**WARNING** - To reduce the risk of fire, electric shock, or injury to persons, read the **IMPORTANT SAFETY INSTRUCTIONS** before operating this appliance.

## 1 Sort your laundry.

See the "Advice and Tips" section before washing.

### Note!

Place underwired bras in a laundry net.

### Note!

Empty pockets. Coins, nails, and the like can cause damage to the machine and fabrics. See the "Advice and Tips" section before washing.

## 2 Turn on the main power switch.

## 3 Open the washer door and load the laundry

If the door is closed, press the Door Opening button (key symbol). The door will open after a few seconds. Load the laundry. The laundry program chart shows how much laundry can be washed with each program.

## 4 Add detergent and fabric softener, as required

The detergent packaging will have recommendations for how much detergent you should use. The machine holds 13lb (6kg) of laundry. If you only have a small amount of laundry in the machine, you can reduce the amount of detergent used.

### Powder detergent

Pour the powder into the main wash compartment, and pre-wash compartment as well if desired.

### Liquid detergent

When using liquid detergent, follow the chart on page 15 for recommended detergent amounts. We recommend always using a wash ball with very thick liquid detergent.

### Wash ball or net

If you use a wash ball or net, place it directly in the drum and select a program without pre-wash.

### Note!

Detergent overdosing does not give better washing results; it merely causes a greater impact on the environment.

Try using less detergent, and increase only if you are not satisfied with the results.

# Operating instructions

## Fabric softener

Pour the fabric softener into the compartment with the  symbol. Follow the recommendations on the fabric softener packaging.

### Note!

Do not fill above the compartment's maximum fill level. Otherwise fabric softener will be dispensed too early, which impairs the washing effect.

## Detergent compartment



Push here to open.

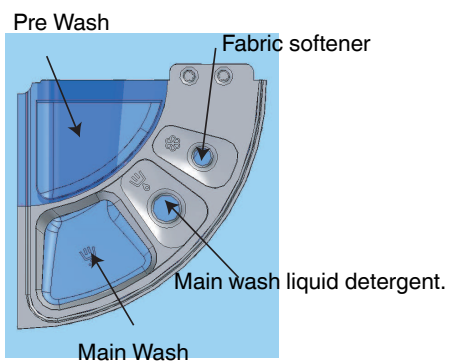

**WARNING** - To reduce the risk of fire, electric shock, or injury to persons, read the **IMPORTANT SAFETY INSTRUCTIONS** before operating this appliance.

# Operating instructions

## 5 Select the program

You select a program by turning the program selector. The name of the selected program and its end time are displayed. Select the desired options using the option buttons. Press the Start/Stop button to start.

### 1. Auto

This program automatically adjusts the length of the main wash and the number of rinses to the amount and type of laundry loaded in the machine.

### 2. Time Choice

This program adjusts itself to the specified time frame or finish time. When using this program, it is however important to select a temperature and time suited to how soiled the laundry is. The spin speed can be selected freely.

Specify the desired program time by pressing + or - on the Time button. The symbol for the program lights beside the selected time. You can choose a program time between 30 minutes and 3 hours. If you choose a 30-minute program time the maximum wash temperature will be 86°F (30°C)

### 3. Sani

Program for heavily soiled laundry, with dirt that needs to be fully dissolved before the main wash. A pre-wash is used to do this. You can select the temperature freely, so follow the washing instructions for each garment. The highest temperature, 203°F (95°C), is suitable for very heavily soiled laundry. The spin speed can be selected freely. The machine adapts the program time and water consumption to the load size.

### 4. Stain

Program for normally to heavily soiled laundry, whites and colors. You can select the temperature freely, so follow the washing instructions for each garment. 140°F (60°C) is a good temperature for heavily soiled cotton garments, as well as for garments worn next to the skin. Select 104°F (40°C) if the laundry is less soiled. The spin speed can be selected freely. The machine adapts the program time and water consumption to the load size.

### 5. White

A standard program for lightly to moderately soiled laundry. The temperature can be selected freely, so follow the washing instructions for each garment. Garments worn next to the skin ought to be washed at 140°F (60°C). The spin speed can be selected freely. The machine adapts the program time and water consumption to the load size.

### 6. Color

Standard program for lightly soiled laundry. The temperature can be selected freely, so follow the washing instructions for each garment. Garments worn next to the skin ought to be washed at 140°F (60°C). Very lightly soiled laundry, however, often comes clean at 104°F (40°C). The spin speed can be selected freely.

### 7. Quick

Lightly soiled laundry that just needs freshening up. You can choose the inlet water temperature (the machine does not warm the water), 104°F (40°C), or 140°F (60°C).

Fast program for laundry that just needs freshening up. The program can be run at any temperature, so follow the washing instructions for each garment. The lower the selected temperature, the shorter the program time. Garments worn next to the skin ought to be washed at 140°F (60°C). The spin speed can be selected freely.

# Operating instructions

## **8. PermaPress**

Program for synthetics, blended materials, and permanent press cotton. Suitable for shirts and blouses. The temperature can be selected freely, so follow the washing instructions for each garment. Garments worn next to the skin ought to be washed at 140°F (60°C). Many synthetics will come clean at 104°F (40°C) too. The maximum spin speed is 800 rpm.

## **9. Wool/Delicate / Hand**

A gentle laundry program for wool, silk, and garments that should be washed by hand. The highest temperature is 104°F (40°C). The program has a short spin. The maximum spin speed is 800 rpm.

## **10. Rinse**

This program performs one cold rinse cycle + spin. Suitable for laundry that just needs to be dampened and for cleaning cloths and mops.

## **11. Spin or 12. Drain**

To be used when you only want to spin the load or drain the water from the machine.

# Operating instructions

## Menu overview

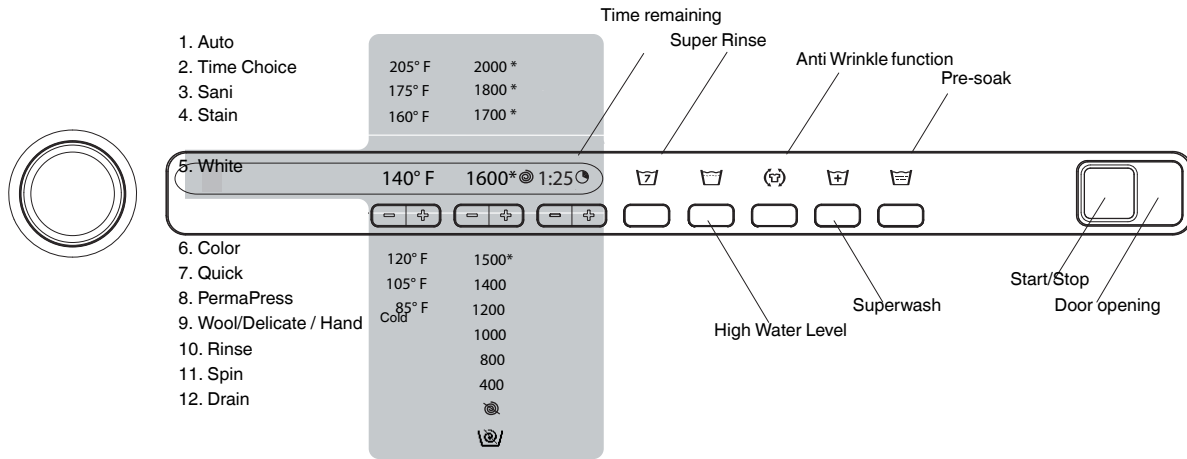

\*Only applies to certain machines



Super Rinse



High Water Level



Anti Wrinkle function



Superwash



Pre-soak

## Note!

The illustration shows an example of a program.

## Program chart

Program	Pre Wash	Temp. °F	Normal number of rinses	RPMs	Max. load	Water consumption (approx. gal-lon)	Energy consumption (approx. kWh)	Program time (approx. min)
1. Auto	No				1/1			
2. Time Choice	No				1/1			30-180
3. Sani	Yes	140	5	1600	1/1	18.5	1.0	150
4. Stain	No	140	3	1600	1/1	14.3	1.02	135
5. White	No	140	3	1600	1/2	14.5	1.0	90
6. Color	No	140	3	1600	1/2	11.9	0.6	75
7. Quick	No	140	3	800	1/2	7.9	0.6	45
8. PermaPress	No	104	4	800	1/2	10.6	0.4	80
9. Wool/ Delicate / Hand	No	86	3	800	1/3	21.1	0.5	45
10. Rinse	No		1	1600	1/2	4.0	0.1	20
11. Spin				1600	1/2		0.1	15
12. Drain								1

# Operating instructions

## 6 Close the door and press the Start/Stop button

### Time remaining

The time remaining is shown in hours and minutes. During the actual program, the time counts down in minutes. Once a program is selected, the estimated program time is displayed. This may differ from time to time depending on the temperature of the water entering the machine and the size of the load. If the program time is longer than the previous wash using the same program, "1" will be displayed until the program finishes. This is normal! The next time you use the program under similar conditions, the estimated program time will be more accurate.

### To add or remove laundry after the program starts

If you want to add or remove items after the program has started, you can stop the program by pressing and holding the Door Opening button (key symbol) for three seconds. "Door" appears on the display. When you restart the machine, add any extra detergent needed and close the door. The machine continues automatically from the point where the program was interrupted.

### Stopping or changing a program

You can also stop a program by pressing the Start/Stop button for three seconds. "Stop" appears on the display. To restart the machine, select a new program, add any extra detergent needed, and press the Start/Stop button.

## 7 Once the program has finished

Once a program has finished, "End" appears on the display.

The door opens automatically once the program has finished. If you want to deactivate Automatic Door Opening, see the "Selecting settings" section.

- Remove the laundry.
- Turn off the main power switch and you will save energy.

If you have small children or pets at home, close the washer door once you have removed the laundry.

# Selecting Options

You can select options to adjust the washing program to suit your own specific requirements. The machine remembers which options you chose for a program (with the exception of Delayed Start) the next time you select the same program. Of course, you can change this if you want.

## Temperature

1. Select the temperature by pressing the -/+ buttons until the desired temperature is displayed.
2. You can select temperatures between Cold and 203°F (95°C). If you select Cold, the washing temperature will be the same as that of the water entering the machine. For Wool/hand wash you cannot choose a temperature higher than 104°F (40°C) and the maximum temperature for the Time Choice program is 140°F (60°C).
3. Press the Start/Stop button to start the program or select more options.

## Spin

1. Select the spin speed by pressing the -/+ buttons until the desired spin speed is displayed.
2. You can select speeds between 400 and 1600 rpm, No spin, or No drain. A spin with a speed of 400-800 rpm is always a short spin. For the Wool/hand wash and PermaPress programs you cannot choose a spin speed higher than 800 rpm.
3. Time Choice has a maximum speed of 1600 rpm.
4. No spin means that the program does not include a spin cycle and ends by draining. No draining means that the program does not include a spin cycle and ends with the water from the final rinse still in the machine. The washing will remain covered by the water from the final rinse and therefore will not become wrinkled.
5. In order to remove the laundry from the machine, select either a Spin or Drain program or press the Door Opening button (key symbol) to drain the water from the machine.
6. Press the Start/Stop button to start the program or select more options.

## Delayed Start

Select Delayed Start by pressing the + button on the Time button. The display shows Delayed Start for 3 seconds. You can delay the start by between 1 and 24 hours. The number of hours selected is shown in whole hours. Press the - button to reduce the number of hours of delay. The symbol for Delayed Start lights beside the number of hours. Press the Start button. The machine counts down 1 hour at a time and starts after the selected delay. This option cannot be used with the Time Choice program.

## Super Rinse

Use the Super Rinse option if you want to increase the number of rinses. The maximum number of rinses is seven and varies depending on the selected program. This option cannot be selected with the Auto, Time Choice, Rinse, Spin, or Drain programs.

- Select Super Rinse by pressing the button under the symbol.
- The symbol above the button lights when this option is activated.

# Selecting Options

## High Water Level

High Water Level means additional water is used during the main wash and rinse cycles. Can be used with all programs except Auto, Time Choice, Wool/hand wash, and Rinse.

- Select High Water Level by pressing the button under the symbol.
- The symbol above the button lights when this option is activated.

### Note!

The machine takes in the additional water for High Water Level about 15 minutes after the main wash has started.

## Anti Wrinkle function

Anti Wrinkle means that the drum will rotate for three seconds per minute for two hours once the wash program has finished. This function prevents the clothes from lying in the same position and getting wrinkled. This is a useful feature if you cannot take the laundry out straight away. Can be used with all programs except Auto, Time Choice, Wool/hand wash, No spin, and Rinse.

- Select Anti Wrinkle by pressing the button under the symbol.
- The symbol above the button lights when this option is activated.

## Super Wash

Super Wash increases the time during which water is pumped into the machine. The amount of water must suit the load if stains and dirt are to be washed out, while the main wash time is also increased. Can be used with all programs except Time Choice, Quick, Wool/hand wash, and Rinse.

- Select Super Wash by pressing the button under the symbol.
- The symbol above the button lights when this option is activated.

## Pre-soak

If the laundry is stained, such as with blood, we recommend a presoak. The laundry will be soaked in cold water for two hours before the wash program starts. Can be used with all programs except Auto, Time Choice, and Rinse.

- Select Presoak by pressing the button under the symbol.
- The symbol above the button lights when this option is activated.



# Settings

## You can change the following settings:

- Child-safe Start
- Automatic Door Opening
- Language

## Child-safe Start

### Activating/deactivating Child-safe Start

You can activate the Child-safe Start option to prevent children from starting the machine.

- Turn off the machine using the main power switch.
- Press and hold the + on the Time button and the Super Rinse button and turn on the main power switch.
- Turn the program selector and choose "Child-safe Start Off" or "Child-safe Start On".
- Press the Start/Stop button to store.

You can deactivate Child-safe Start by pressing the Super Rinse and Start/Stop buttons at the same time:

The Child-safe Start option will be temporarily deactivated for three minutes.

## Automatic Door Opening

The standard setting is for the washer door to open automatically when the program has finished. If for any reason you do not want the door to open automatically, you can program the machine so that the door only opens when you press the Door Opening button. Do as follows:

- Turn off the machine using the main power switch.
- Press the main power switch and the Super Rinse button
- "Door open" is shown on the display.
- Press the Start/Stop button to store.

## Select language

Follow these instructions:

- Turn off the machine using the main power switch.
- Press the main power switch and the Start/Stop button
- Turn the program selector to choose from: US English, English, Svenska, Dansk, Norsk, Suomi, Francais, Deutsch, Italiano, Espanol, Русский, Nederlands.
- Press the Start/Stop button to save.

# Care and maintenance instructions

## Checking the filter and drain pump

The washing machine has a filter, where coins, hairpins, and the like can get caught. To clean the filter and drain pump:

1. Make sure the machine is empty of water and that it is switched off at the main power switch.

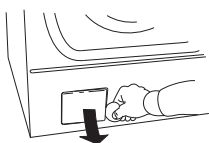

2. Open the hatch for the drain pump as shown in the illustration.

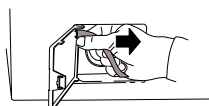

3. Drain out the water, into a bowl, for example, by unhooking the drainage hose from the pin inside the hatch.

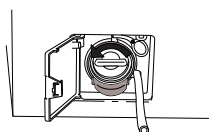

4. Open the pump by unscrewing the cover counterclockwise. Remove the cover with the filter.

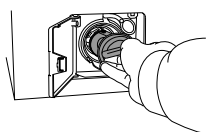

5. Remove any objects or debris from the pump housing. Check to see that the pump impellers at the back will rotate.

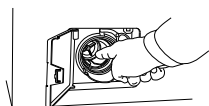

6. Screw on the cover, replace the drainage hose on the hatch pin, and close the hatch.

## Cleaning the detergent compartment

Open the detergent compartment and lift out the insert. Rinse it and scrub it clean with a dish brush. Replace the compartment.



### Note!

Do not run the detergent compartment through a dishwasher!

## Cleaning the outside of the machine

Clean the outside of the machine and the program panel with a mild cleaner. Do not use any solvents, as these can damage the machine.

### Note!

Do not hose down or spray the machine with water.

## Cleaning the inside of the machine to avoid unpleasant smells

Modern detergents often allow laundry to be washed at low temperatures. This means that small deposits can build up in the machine. These, in turn, may lead to unpleasant odors developing.

To avoid this, we recommend running a 203°F (95°C) wash program once a month. When you do this, use a small quantity of detergent. It is not necessary to put any laundry in the machine.

# Care and maintenance instructions

## Rinse holes under the paddle

If you think that an object, such as a nail or a paper clip, may have fallen through the wash drum, you should check the container under the paddle. Objects of this kind can rust and cause spots on clothing. Nails and other sharp objects can make holes in fabric.

### Do as follows:

1. Use a screwdriver or similar tool.
2. Insert the screwdriver into the center hole on the paddle and turn the screwdriver handle gently to the left.

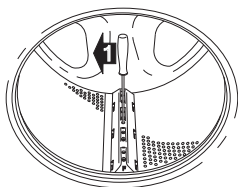

3. With your other hand, hold the paddle and pull it toward you as shown in the illustration.
4. Lift the paddle.

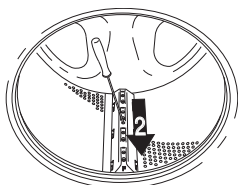

5. Remove any objects.
6. Place the paddle in the mounting hole with the F-mark toward you. Ensure that all the paddle fasteners are in their holes in the drum. Push it away from you until it catches.

## If you have hard water

If you live in an area with hard water (limescale), the washer drum may develop a grayish-white coating. To remove this, empty a sachet of citric acid, approx. 20gram (1ounce), into the washer drum and run the Stain - Color program at 203°F (95°C). Repeat if necessary.

# Troubleshooting

## The washer door will not open

1. Check that the main power switch is on.
2. Has the power supply been cut off? Check the house fuses (circuit breakers). The washer door cannot be opened using the button with the key symbol if the power supply has been cut off.

### If nothing else works, the washer door can be opened as follows:

- This must only be done in an emergency if the machine's glass door does not open automatically when the program has finished.
- First check that there is no water left in the machine. If there is water left in the machine and it is not possible to run the Drain program, empty the machine. This is described under the heading "Checking the filter and drainage pump" in the "Care and cleaning" chapter.
- Make sure that the main power switch is off and that the plug has been removed from the wall socket.
- You will find the emergency opener for the glass door in the double sealed bag.
- Open the glass door by putting the opener in the slot to the right of the lock on the door. Push the opener up or down and the door will open. Illustration 3.

Illustration 3.

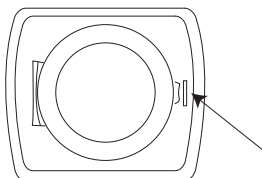

If the machine's glass door does not open the next time a washing program finishes, call the Customer Care Center at the number at the bottom of this page.

## The machine will not start

1. Is the washer door properly closed? Push it firmly.
2. Is there power? Check the house fuses.
3. Check that you have not selected Delayed Start. Stop the program if you want.

# Troubleshooting

## Error messages

The display indicates whether an error has occurred during the program. After taking the measures described below, turn off the machine to exit error message mode.

The error messages that may be shown are:

### The door is not closed

If the display shows Close the door, you tried to start a program with the washer door open. Close the door and the program will start.

### Over filling

If the display indicates Over filling:

1. Shut off the water tap.
2. Contact the Customer Care Center at the number listed at the bottom of this page!

### Drainage error

If the display indicates a Drainage error, check:

- that no objects are stuck in the drainage hose outlet.
- that the drain pump is not blocked by foreign objects. Clean the pump (see the "Care and cleaning" chapter).
- that there are no kinks in the drainage hose.

After taking the necessary action, run the Drain program or press the Door Opening button (key symbol) to empty the machine. If the problem persists, contact the Customer Care Center at the number listed at the bottom of this page!

## Water intake error

If the display indicates a Water inlet fault, check:

Fault with water supply. Check:

- that the tap on the water pipe is open.
  - that the filter in the machine's water intake is not blocked.
1. Shut off the water tap.
  2. Unscrew the hose.
  3. Clean the filter in the intake valve on the machine.
  4. Screw the hose back on.
  5. Turn on the tap.
  6. Run the program again to check whether the error has been fixed.
  7. If the problem persists, contact the Customer Care Center at the number listed at the bottom of this page!

## Door opening error

If the display indicates a Door opening error. Contact the Customer Care Center at the number listed at the bottom of this page!

## Motor fault

If the display indicates a Motor fault. Contact the Customer Care Center at the number listed at the bottom of this page!

# Technical information

## Technical data

Height:	33 1/2" (850mm)
Width:	23 7/16" (595mm)
Depth:	23.0" (585mm)
Weight:	161 (172)lb (with outer door)
Cylinder volume:	13.2gal (50l)
Max. laundry capacity:	13lb (6kg)
Spin speed (rpm)	400 - 1600
Rated power:	See serial number tag and rating plate.
Heater output:	See serial number tag and rating plate.
Water pressure:	14-145 psi
Wash drum and liquid compartment material:	Stainless steel
Outer casing material:	Powder-coated and hot-galvanized sheet steel or stainless steel.
Water connection:	59" (1.5m) pex pipe
Drain:	67" (1.7m) polypropylene hose

# Transport protection

Before the machine is used, the three transport protection devices should be removed as shown below.

Each transport protection device consists of a screw, a washer, and a rubber spacer. After the protection device has been removed, the rubber spacer acts as a plug for the holes for the device and also as a damper.

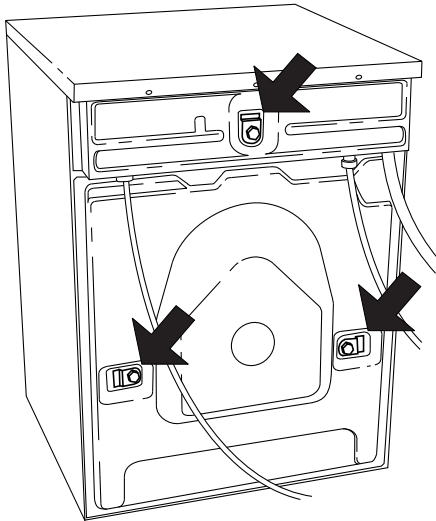

- First remove the screws and the washers.

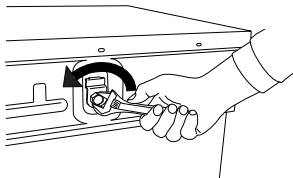

- Then remove the rubber spacers.

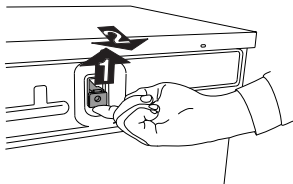

- Finally, the rubber spacers should be turned over and replaced in the transport protection device holes.

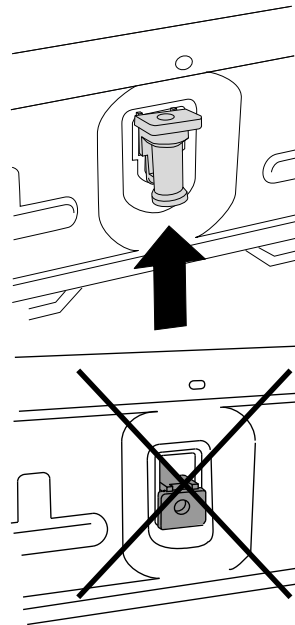

## Important!

In order to prevent the machine from being damaged when transported, use the transport protection device, which locks the entire inner compartment in place. If the transport protection device is missing, you can order one from your retailer.

Item number:

8064206-UL Rubber spacer

8901037 Bolt

8061767 Washer

Order three of each item!

# Installation instructions

Read these instructions carefully and completely before you install the machine. The installation should be carried out by a qualified person who is familiar with all local codes and ordinances for electrical and plumbing connections.

Cosmetic damage must be reported to your dealer within five days from the date of purchase. After unpacking the washer, thoroughly check the unit for cosmetic damage.

## Leveling the machine

It is important that the machine is level to prevent excessive vibrations during spin cycles. Each foot of the washer is adjustable, so you can level the washer on any surface. Once it is level, securely tighten the lock nuts on the feet to prevent excessive vibration during spin cycles.

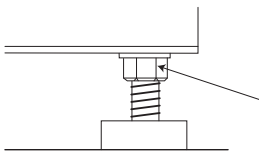

Be sure to tighten the lock nuts securely when you level the machine.

## Water supply connection

Since ASKO washers have a built-in heating element, you only need a cold water inlet. The connection should be made by someone who is sufficiently skilled. Use the hose supplied with the washer. (The inlet hose is marked for correct connection.) The water pressure must be in the range 15–146 PSI. A tap should be fitted on the water supply pipe. If a new supply pipe has been installed for the washer, it should be flushed thoroughly to remove any foreign particles that might clog the filter in the water inlet.

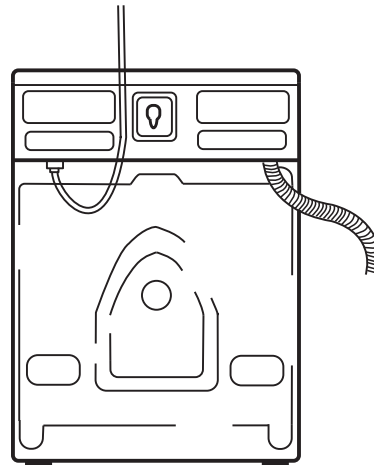

### Note!

If the unit is installed on a second storey, follow local building codes. We recommend installing a drip pan.



# Installation instructions

## Drain outlet connection

The machine is supplied with the outlet hose already attached. The hose should be extended over a suitable sink edge or drain pipe at a height of 24" to 36" (610 mm to 914 mm) above the bottom of the unit. (The lower height is preferable.) Make sure the hose is not kinked.



### Note!

If the hose is extended, the internal diameter of the coupling must not be less than 1/2".

### Warning!



Do not extend the drain hose higher than 36" (914 mm) from the bottom of the unit.

## Electrical Connections

The machine is delivered ready-fitted with a plug and is intended for connection to an ASKO Dryer, which is equipped with a matching receptacle. The plug supplied with the washer can only be used with an ASKO Dryer. If the washer is used separately or with another dryer, it must be on a separate 220 V single-phase circuit. If the machine is to be used in a wet area, the supply must be protected by a residual current device. As supplied: 230 V, 60 Hz, 2000 W heating element, 15 A timed delayed fuse is required.

### Warning!



Connection to a permanently wired supply point must be made only by a qualified electrician.

## Grounding instructions

This appliance must be grounded. In the event of malfunction or breakdown, grounding will reduce the risk of electric shock by providing a path of least resistance for electric current. This appliance is equipped with a cord having an equipment-grounding conductor and a grounding plug. The plug must be plugged into an appropriate outlet that is properly installed and grounded in accordance with all local codes and ordinances.

## Freestanding installation

The washer can be placed next to the dryer. It is essential that the machine is leveled and the locknuts are tightened to prevent excessive vibration during spin cycles. Also be sure to leave a minimum of 1/2" of space between the washer and the dryer. The height adjustment for the washer is 33 1/2" to 34 1/2" (850 mm to 876 mm). Do not raise it higher than 34 1/2" (876 mm).

### Warning!



Improper connection of the equipment-grounding conductor can result in a risk of electric shock. Check with a qualified electrician or serviceman if you are in doubt as to whether the appliance is properly grounded. Do not modify the plug provided with the appliance. If it will not fit the outlet, have a proper outlet installed by a qualified electrician.

## Stacked installation

ASKO washers should never be stacked on a counter or a dryer. You can, however, stack an ASKO dryer on an ASKO washer. Refer to your Dryer Use and Care Guide for instructions on how to do this.

# Installation instructions

## Built-in installation

ASKO washers can be installed beneath a cabinet or worktop with a height of 34½" (876 mm) or in a closet. There must be a gap of about ½" (12 mm) all around the machine, including between the rear edge of the machine's top panel and the back wall. The opening width must be at least 24½" (622 mm). Space must also be available for the inlet and drain hoses. See the illustration below for measurements and positions. If the washer is installed in a closet the door shall be opened while the washer is running.

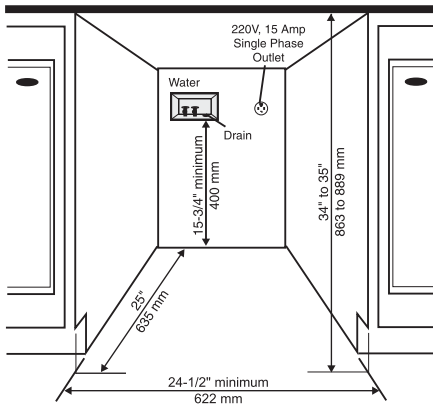

If the drain outlet is higher than 24" (610 mm), the connections will need to be recessed.

# Reversing the door

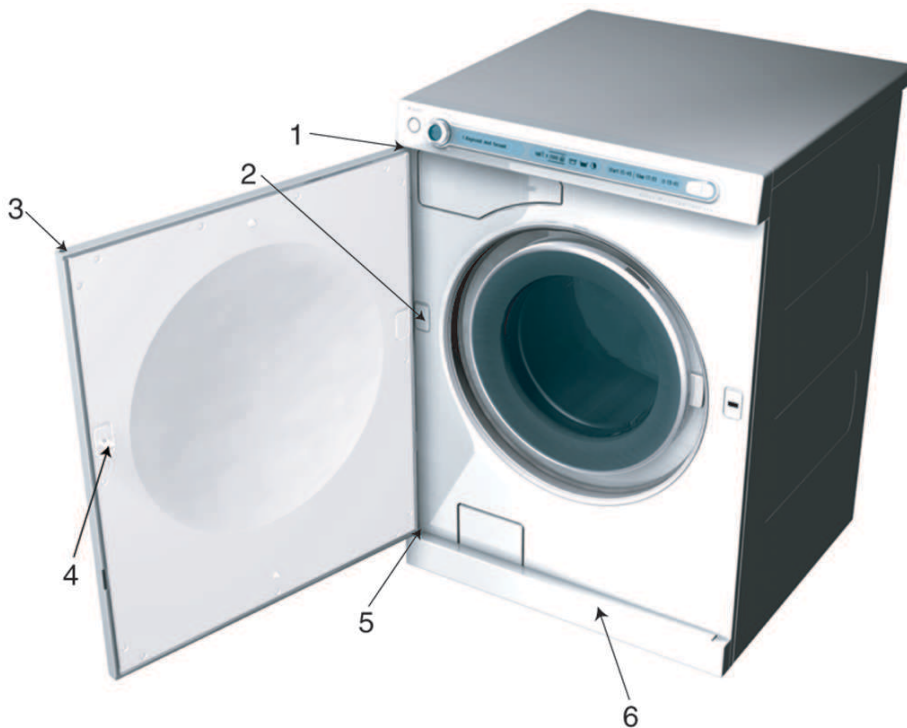

1. Hinge pins (top and bottom)
2. Cover washer
3. Plastic plugs (on the upper and lower edges)

4. Lock hook
5. Hinges (left + right side)
6. Toe kick

# Reversing the door

You can choose whether the door is hung on the right or the left.

## Follow these instructions:

1. Remove the Toe kick.
2. Unscrew the 2 screws on the hinges.



3. Lift the door up and remove it. Support the door while doing this.
4. Remove both door pins (top and bottom). Fit them on the opposite side of the door. Refit the hinges.

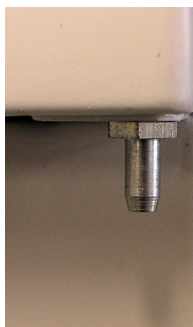

5. Undo and remove the lock hook (lift up and pull out) and the cover washer from the door and the machine. Fit the hook and the washer on the other side.



6. Move the plastic plugs on the upper and lower edges of the door. Use a flat screwdriver to remove the plugs.



7. Refit the door by loosening the hinge screws slightly, affixing the door, and closing it. Retighten the hinges. Replace the Toe kick.

# Service and guarantee

It is important to register your product warranty by logging onto [www.askousa.com/customer-care/registration](http://www.askousa.com/customer-care/registration) and filling out all required fields within 90 days from the date of purchase. After doing so, you will be e-mailed a certificate that will extend the original warranty for one additional year. If you do not have access to the internet, complete the warranty card included with the product and mail it to the address on the warranty card within 90 days of the date of purchase. Cosmetic damage must be reported to your dealer within five days from the date of purchase. After unpacking the washer, thoroughly check the unit for cosmetic damage.

For residential installations only	ASKO Appliances Inc. will pay for:
Length of warranty Two-Year Full From date of purchase.	ASKO replacement parts and/or repair labor to correct defect in materials or workmanship. Service must be provided by an authorized ASKO service agent.
Third Year Full Complete your product warranty registration online at <a href="http://www.askousa.com/customer-care/registration">www.askousa.com/customer-care/registration</a> within 90 days from the date of purchase to extend the original warranty one additional year. If you do not have access to the internet, complete the warranty card included with the product and mail it to the address on the warranty card within 90 days of the date of purchase.	ASKO replacement parts and/or repair labor to correct defect in materials or workmanship. Service must be performed by an authorized ASKO service agent.
Lifetime	ASKO replacement parts (labor cost not included) for the stainless steel tank if it exhibits a manufacturing defect such as cracking or rusting through. Service must be provided by an authorized ASKO service agent.
<b>For non-residential installations One-year Full Warranty</b> From date of purchase.	ASKO replacement parts and/or repair labor to correct defect in materials or workmanship. Service must be provided by an authorized ASKO service agent.

# Service and guarantee

## Warranty

### **ASKO Appliances Inc. will not pay for:**

Service calls to:

1. Correct the installation of the appliance.
  2. Repair damage due to shipment, delivery, installation, misuse or abuse.
  3. Instruct how to use the appliance.
  4. Replace house fuses or correct house wiring.
  5. Correct house plumbing, including drainage problems related to improper installation.
  6. Clean or service air device in drain line.
- Repair and/or replacement parts for failure of product if appliance is used for other than home/residential use.
  - Damage resulting from accident, fire, floods, acts of God, alteration, misuse, abuse, improper installation, or installation not in accordance with local electrical or plumbing codes.
  - Any shipping costs for parts during the limited warranty period.
  - Replacement parts or repair labor costs for units operated outside the continental United States.
  - Pickup and delivery. ASKO washers are designed to be repaired in the home.

### **In no event shall ASKO Appliances Inc. be responsible for any incidental or consequential damages.**

Some states will not allow the exclusion or limitation of incidental or consequential damages, so this exclusion or limitation may not apply to you. This warranty gives you specific legal rights and you may also have other rights which vary from state to state.

### **For warranty service, contact our Customer Care Center at the number listed below.**

Before calling for service or contacting ASKO Appliances Inc. regarding a warranty issue, make a note of the model, type name, and serial number.

## **How to contact the ASKO Appliances Inc.**

### **Write to us at:**

ASKO Appliances Inc. P. O. Box  
851805 Richardson, Texas 75085-  
1805 [www.askousa.com](http://www.askousa.com)

### **Or contact our**

Customer Care Center at 1-800-898-  
1879 [www.askousa.com](http://www.askousa.com)

# Notes

# Quick guide

## 1 Washing

- Empty pockets and close zippers.
- Read the item's laundry label.
- Sorting laundry.

### Note!

Place underwired bras in a laundry net.

## 2 Load the laundry

- Pressing the main power switch.
- If the door is closed, press the Door Opening button (key symbol) and the door will open after a few seconds.
- Load the laundry and close the door.

## 3 Detergent compartment

- Pour detergent into the main wash compartment, and pre-wash compartment as well if required. Pour fabric softener into the compartment on the right with the  symbol.
- If you use liquid detergent, follow the detergent manufacturer's recommendations.
- If you use liquid detergent, use the accompanying divider. Place it in the filter at the back of the detergent compartment. Pour detergent directly into the main wash compartment.

## 4 Select the program

- Select a program by turning the program selector.
- Select options and settings.
- Press the Start/Stop button.

## 5 Program finished

- "End" on the display indicates that the wash program has ended.
- The washer door opens automatically once the program has finished.
- Remove the laundry.
- Turn off the main power switch.

If you have small children or pets at home, close the washer door once you have removed the laundry.