

# Danby®

OWNER'S MANUAL

MANUEL  
D'UTILISATION

Model • Modèle

**DPAC90061**  
**DPAC11007**

**CAUTION:**

Read and follow all safety rules and operating instructions before first use of this product.

**MISE EN GARDE :**

Veillez lire attentivement les consignes de sécurité et les directives d'utilisation avant l'utilisation initiale de ce produit.

# Danby®



## Danby®

PORTABLE 3 SEASON HOME COMFORT

Table of contents ..... 1

## Danby®

APPAREIL DE CONFORT AU FOYER

PORTABLE 3 SAISONS

Table des matières ..... 22



Danby Products Ltd, PO Box 1778, Guelph, Ontario Canada N1H 6Z9  
Danby Products Inc, PO Box 669, Findlay, Ohio USA 45839-0669

01.01.07

## Table Of Contents

	Page
Introduction and Unit Specifications . . . . .	2
Electrical and Important Safety Information . . . . .	3
Energy-Saving Tips. . . . .	5
Window Installation. . . . .	7
External Water Tank Instructions . . . . .	6
Care and Maintenance . . . . .	20
Warranty . . . . .	21

## Unit Parts Identification

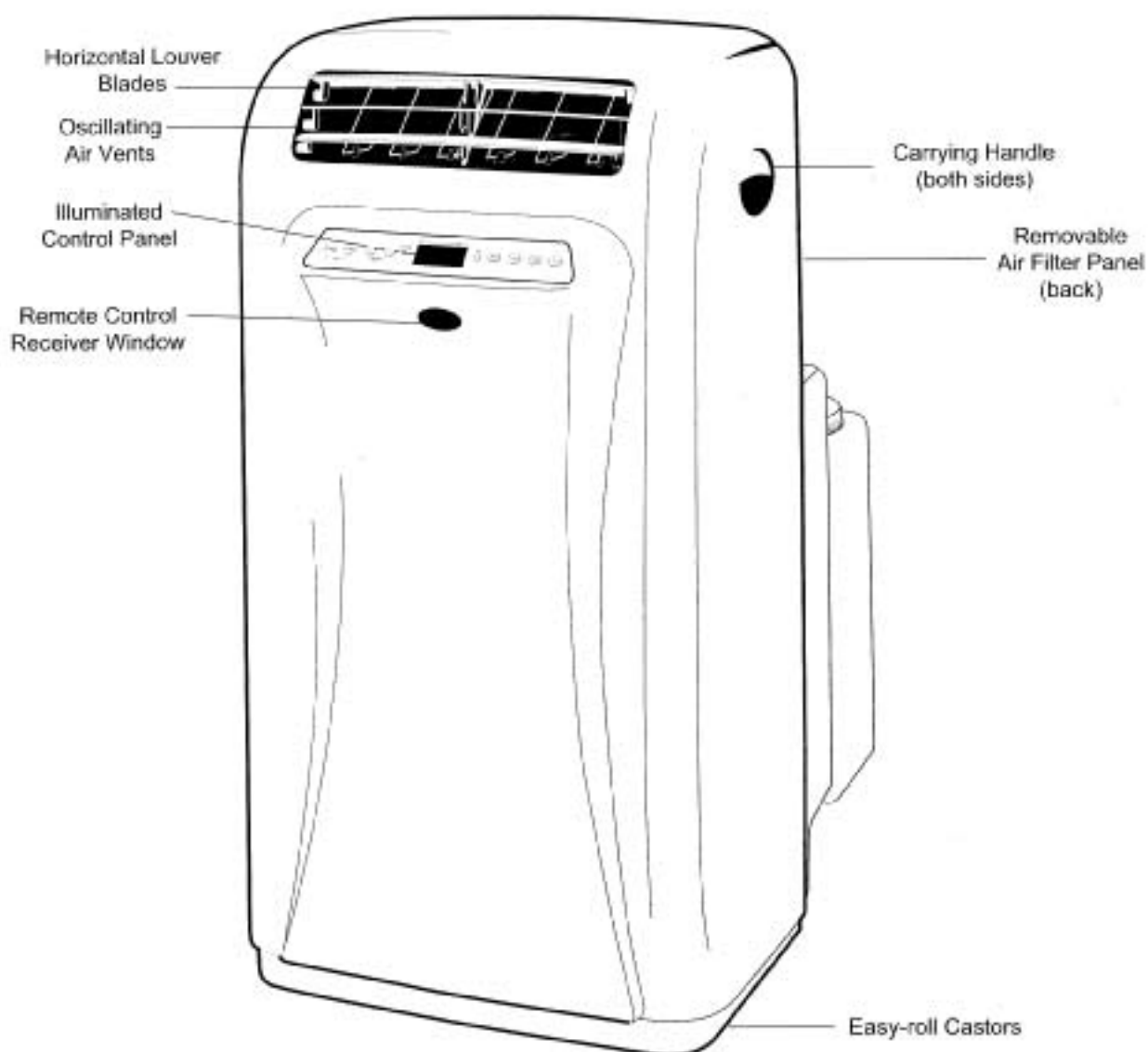

## Introduction

Thank you for choosing an Danby appliance to provide you and your family with all of the "Home Comfort" requirements for your home, cottage or office. This Owner's Manual will provide you with valuable information necessary for the proper care and maintenance of your new appliance. If properly maintained, your Danby appliance will give you many years of trouble free operation. Please take a few moments and read the instructions thoroughly and familiarize yourself with all of the operational aspects of this appliance.

Your Danby Portable Air-Conditioner is a multi-functional room air-exchanging, air-processing appliance, designed to offer you the functions of: Air Conditioning, Dehumidifying and Independent Fan. Each individual mode, is featured with "oscillating" air swing capabilities. This unit can be conveniently moved from room to room within your home and set-up in just minutes. Imagine the convenience of 3 Season Home Comfort at your fingertips, anytime, anywhere. Just sit back and wait to feel what "Mother Nature" has forecast and respond with the push of a button.

For easy reference, may we suggest you attach a copy of your sales slip/receipt to this page, along with the following information which is located on the manufacturers nameplate located on the rear panel of the unit.

Model Number: \_\_\_\_\_

Serial Number: \_\_\_\_\_

Date of Purchase: \_\_\_\_\_

Dealer's Name and Address: \_\_\_\_\_

This information will be required if your unit requires servicing and/or for general inquiries. To contact a Customer Service Representative, call Danby TOLL FREE. **1-800-26-DANBY**

<b>Unit Specifications:</b>	<b>DPAC90061</b>	<b>DPAC11007</b>
Cooling Capacity	9000 Btu/h	11000Btu/h
Dehumidifying Capacity	68 Pints (32.2L / 24 Hrs)	70 Pints (33.1L/24Hrs)
Noise Level	50dB (A)	50 dB (A)
Airflow CFM High / Medium / Low	450 / 380 / 300	450 / 380 / 300
Power Source	115 V / 60 Hz	115 V / 60 Hz
Refrigerant	R22	R22
Internal Reservoir Capacity	1.9 L (4.0 Pints)	1.9 L (4.0 Pints)
External Water Tank Capacity	15 L (31.7 Pints)	15 L (31.7 Pints)
Unit Weight	46.1 kg (101.7 lb)	46.1 kg (101.7 lb)
Unit Dimensions (inches) W x D x H	17-1/2" x 20" x 33-11/16"	17-1/2" X 20"X33-11/16"
Unit Dimensions (cm) W x D x H	44.5 x 51.0 x 85.5	44.5 X 51.0 X 85.5
Fan Speeds	3	3
Control Panel (Illuminated)	Soft Touch Controls	Soft Touch Controls
Remote Control	Yes	Yes
Time of Day Clock	Yes	Yes
Auto - Timer	Yes	Yes
<b>Power Consumption:</b>		
Cooling	1100 Watts (10 Amps)	1200 Watts (11 Amps)
Dehumidifying	1100 Watts (10 Amps)	1200 Watts (11 Amps)
Fan	90 W (0.8 Amps)	90 W (0.8 Amps)

**NOTE:** Continuing research results in steady improvement. Therefore, this information and these specifications are subject to change without notice.

## Electrical Specifications

1. All wiring must comply with local and national electrical codes and be installed by a qualified electrician. If you have any questions regarding the following instructions, contact a qualified electrician.
2. Check available power supply and resolve any wiring problems BEFORE installation and operation of this unit.
3. This appliance draws 10.0 (DPAC90061) / 11.0 (DPAC11007) nameplate amps. under **Cooling Mode** and may be used in any properly wired, general purpose 15 amp household grounded receptacle.
4. For your safety and protection, this unit is grounded through the power cord plug when plugged into a matching wall outlet. If you are not sure whether the wall outlets in your home are properly grounded, please consult a qualified electrician. **DO NOT USE PLUG ADAPTERS OR EXTENSION CORDS WITH THIS UNIT.** If it is necessary to use an extension cord with this unit, use an approved "air conditioner" extension cord only. (available at most local hardware stores)
5. The manufacturers nameplate is located on the rear panel of the unit and contains electrical and other technical data specific to this unit.
6. To avoid the possibility of personal injury, always disconnect the power supply to the unit, before installing and/or servicing.

## Important Safety Instructions

The power cord supplied with this air conditioner contains a current leakage detection device designed to reduce the risk of fire. Please refer to the section "Power Supply Cord" for details. In the event the power supply cord is damaged, it cannot be repaired it must be replaced with a new cord from the Product Manufacturer.

- Under no circumstances should this device be used to turn the air conditioner on or off.
- The 'RESET' button must always be pushed in (engaged) for correct operation.
- The power supply cord must be replaced if it fails to reset when the 'TEST' button is pushed in.
- If the power supply cord is damaged, it cannot be repaired. It must be replaced with a new cord obtained from the Product Manufacturer.

## Power Supply Cord

The power cord supplied with this air conditioner contains a device that senses damage to the power cord. To test if your power supply cord is working properly, you must do the following:

1. Connect the power supply cord to an electrical outlet.
2. The power supply cord is inclusive of two buttons located on the head of the plug. One button is marked 'TEST', the other button is marked 'RESET'. Press the 'TEST' button, you will hear a click as the 'RESET' button pops out.
3. Press the 'RESET' button, you will hear a click as the button engages.
4. The power supply cord is now energized and supplying electricity to the air conditioner. (On some products this is also indicated by a light on the plug head).

**Table 1**

Suggested Individual Branch Circuit	
Nameplate Amps	AWG Wire Size*
10.0 to 11.0	14
AWG- American Wire Gage	
* Based on copper wire at 60°C temperature rating.	

**Table 2**

Receptacle and Fuse Types	
Rated Volts	125
Amps	15
Wall Outlet	
Fuse Size	15
Time Delay Fuse (or circuit breaker)	Plug Type

## CAUTION

Do not leave this unit unattended in a space where people or animals who cannot react to a failed unit are located. A failed unit can cause extreme overheating or death in such an enclosed, unattended space.

## Energy-Saving Tips

You Danby appliance is designed to be highly efficient in energy savings. Follow these recommendations for greater efficiency.

- 1) Select a thermostat setting that suits your comfort needs and leave at that chosen setting.
- 2) The air filter is very efficient in removing airborne particles. Keep the air filter clean at all times.
- 3) Use drapes, curtains or shades to keep direct sunlight from penetrating and heating room, but do not allow drapes or curtains to obstruct the air flow around the unit.

- 4) Start your air conditioner before the outdoor air becomes hot and uncomfortable. This avoids an initial period of discomfort while the unit is cooling off the room. Use of the automatic start/stop programmable **TIMER** feature can be a major asset in this regard if utilized to the fullest extent.
- 5) When outdoor temperatures are cool enough, turn the air conditioner off and use the **FAN MODE** on **HIGH, MED** or **LOW**. This circulates indoor air, providing some cooling comfort and utilizes less electricity.

## Installation

Installation Accessories Fig. 1



### Electric Shock Hazard

To avoid the possibility of personal injury, disconnect power to the unit before installing or servicing.



### CAUTION



To avoid installation/operation difficulties, read these instructions thoroughly.

**Location:** Use this portable air conditioner on a level surface. Water may overflow if your floor is not level and more than 3° inclination angle.

Description	Quantity
Flexible exhaust hose with collars & adapters ..... 2/set stretches from 17-1/2" (44.5 cm) up to 55-1/2" (141 cm)	2
Adjustable window/patio door slider kit ..... 4/set from 28" (71.1 cm) up to 80" (203 cm)	4
Rain Hood (For slider kit) ..... 1 kit see pg #7 for assembly instructions	1

### External Water Tank Accessories Fig. 1a

Support Tray & Castors .....	1 pc
External Tank & (2) Covers .....	1 pc
Drain Hose (Not Shown).....	1 pc
Air Intake Filter Basket (Not Shown).....	1 pc

**SPECIAL NOTE:** The exhaust/window kit must be installed at all times when the unit is operating under **AIR CONDITIONING** mode.



### WARNING



When the patio door kit is installed, it will not be possible to lock the patio door. **THIS COULD POSE A SECURITY RISK!** Installation of a "FOOTBOLT" or "DROP BAR" behind the door is suggested. (Available through most local hardware stores)

There should be at least 11.8" (30 cm) clearance between the unit and any other objects or building structure and should be **installed on a level surface**. The unit does not have to be vented outside during Dehumidifying/Fan mode operation, it is recommended however that the hoses remain installed (on unit) during Dehumidification.

Fig. 1 Installation Accessories

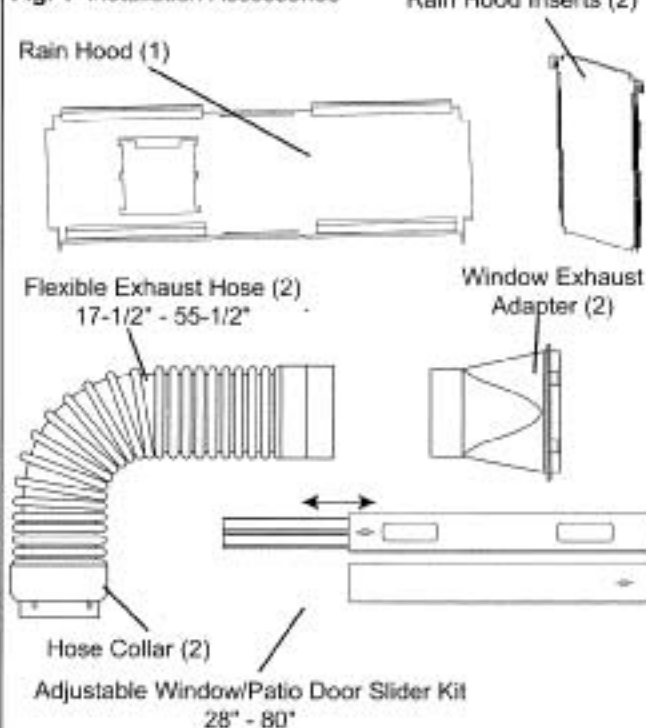
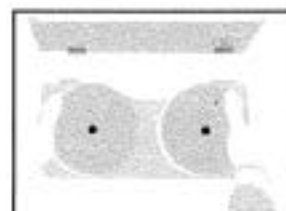

Fig. 1 a External Water Tank Accessories



Support Tray & Castors (1)



External Tank



## External Water Tank Feature:

This unit is equipped with an external water tank which sits on a support tray and is easily attached to the rear side of the unit with the use of the two support hangers (see pg. 12). Align the two support brackets on the external water tank with the support hangers on the rear side of the unit and push down firmly. We recommend the external water tank be connected to the main unit at all times during both air conditioning and dehumidifying modes.

It is possible to operate the unit utilizing the internal water reservoir only. However, running time/operation maybe reduced during high humidity conditions as (excess) condensed water accumulates in the internal reservoir only. Alternatively, when the external water tank is attached, (excess) condensed water is directed first into the internal reservoir and once full, will then be pumped into the external tank, this results in longer (uninterrupted) running times.

### External Water Tank Instructions:

1. Align the holes in the water tank support tray (A) with the screws (B) located at the rear lower section of the unit, push down firmly to lock the tray into position. See Fig. 35

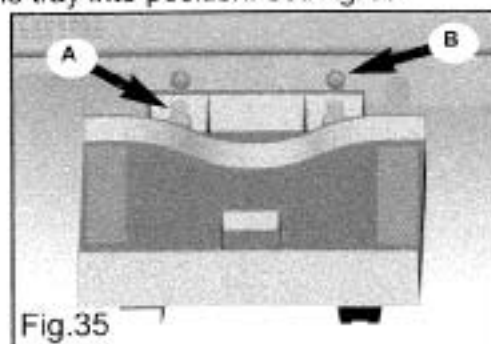

2. Position the external water tank, making sure the inlet on the water tank is aligned with water outlet at the back of the cabinet. See Fig 36.

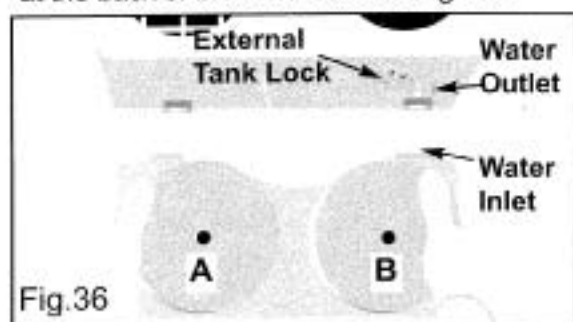

3. To make the connection, simply push the water tank down firmly onto the support hangers on the back of the cabinet and the water tank support tray.

**IMPORTANT:** Once external water tank is installed, ensure that the support brackets located on the water tank are flush with the back of the unit, then secure the tank in place with the locking mechanism (Fig. 37) located above the water outlet. **Please note:** When the tank is installed, the lock and unlock symbols will be hidden - Pull the lock lever to the far right in order to lock the tank into position, and push the lever to the far left to unlock the tank (in order to remove it).

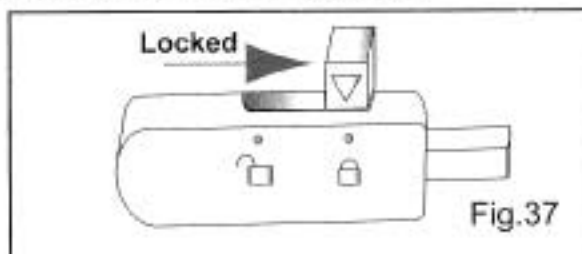

4. Install both covers on the water tank.
5. To release (disconnect) the external water tank, firstly unlock the tank (see above) and grasp the recessed handles located on each side, pull up and remove.

### CAUTION

- Always empty the external water tank before attempting to move or re-locate the unit to another location.
- In order to avoid spillage when emptying the external water tank, remove cover "A" (as identified in fig. 36) and carefully tilt the uncovered portion of the external tank towards the sink.

### Internal Safety Feature

This unit is equipped with a fail-safe switch mechanism which prevents the unit from condensing water in the event the external tank is not being utilized and the internal reservoir becomes full. If this situation occurs, the unit will signal (BEEP) for 20 seconds, and the (RED) WATER FULL indicator light will flash. This condition will remain steady until the external water tank is re-installed (connected) to the unit, at which time the secondary pump will activate and pump the water from the internal reservoir to the external tank allowing normal operation to resume.

**IMPORTANT:** If the red water full indicator on the control panel lights up and remains steady **does not flash**, ensure the external water tank is connected (and empty), then proceed to turn off the power to the unit and temporarily disconnect the power cord. After several seconds reconnect the power cord, switch to air conditioning mode and turn the power to the unit back on, this will pump any excess water out of the internal system into the external tank allowing normal operating conditions to continue.

## Cooling Operation:

During air conditioning mode condensed water accumulates in a pre-cooler drip tray located underneath the evaporator (cooling) coil. When the water level reaches a predetermined level, the water flow is directed into a small (well) holding tank located at the bottom of the unit. When the water level in the well begins to fill, a water pump is automatically activated that pumps the water up to the condenser coil and is subsequently cascaded across the fins of the condenser coil.

This showering action is very efficient in terms of;

- 1) Keeping the condenser coil cool during operation.
- 2) Provides maximum cooling efficiency.

As the water cascades across the heated fins of the condenser coil, it is evaporated. This process minimizes accumulated water from being stored, which results in longer running times and less frequent emptying of the water tanks.

This process is continuous during air conditioning mode only.

**NOTE:** If the external bucket is not installed - During high humidity conditions, if the rate of water being condensed exceeds the rate of water being evaporated, the water level inside the internal reservoir will activate a float switch mechanism (safety shut-off), causing the unit to stop/cease operation automatically. In this event,

- the red "water full" indicator light on the control panel will begin to flash
- and a warning beep will sound.

Installing the external water tank during this condition will activate a secondary pump that will drain the water from the internal reservoir to the external bucket, allowing the water level in the internal reservoir to return to normal and allows the unit to resume operation. When the water level inside the external tank reaches it's maximum level,

- the red "water full" indicator light on the control panel will begin to flash,
- the bucket icon will illuminate in the display area
- and a warning beep will sound.

The unit will stop/cease operation automatically and the external tank will have to be emptied. The fan motor will continue to operate. (this is normal)

## Window / Patio Door Kit Installation

### (Air Conditioning Mode ONLY)

Your window kit has been designed to fit most standard "vertical" / "horizontal" windows and patio doors up to a maximum height of 80". For vertical window and/or patio door applications, lock positions are provided on the front of each slider section. Wing nuts are provided (on the slider section) to secure the section together. Fig. 5a.

### Rain Hood Assembly

1) Fold both sides of the Rain Hood 90° as so the flanges are facing outward. Fig. 1

2) Slide the Rain Hood flanges onto the edges of the slider kit until it is lined up with the intake vent (shown in Fig. 2).

Once the mounting holes on the slider, as well as the Rain Hood are aligned, secure the Rain Hood to the slider with the four mounting screws provided.

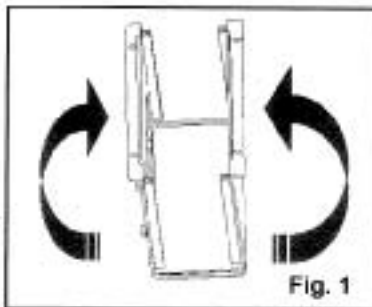

Fig. 1

**Rain Hood is to be installed only over air intake vent**

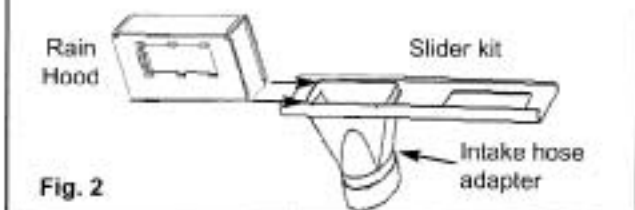

Fig. 2

### IMPORTANT:

- For horizontal window kit applications refer to figure 3a for correct Rain Hood insert positioning.
- For vertical window kit applications (including patio) refer to figure 4a for correct Rain Hood insert positioning.

1) Select a suitable location, making sure you have access to an electrical outlet.

2) Install both flexible hoses to the rear side of the unit. Both hoses are identical and can be installed into either opening. Insert the hose collar with the 2 lock tabs into the 2 slots on the top of each opening and twist to lock into position.

3) Install the adjustable Window/Patio Door Slider Kit as required. Fig's. 3, 4, 5.

4) Install the window exhaust adapters into the openings in the slider section, making sure the window slider sections are secure.

**Important:** Ensure the exhaust adapter labeled "air intake" is installed on the hose that is connected to the air intake opening on the back of the unit.

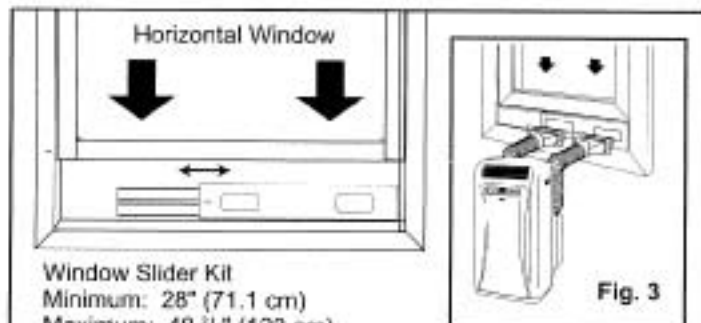

Window Slider Kit  
Minimum: 28" (71.1 cm)  
Maximum: 48 1/2" (123 cm)

Fig. 3

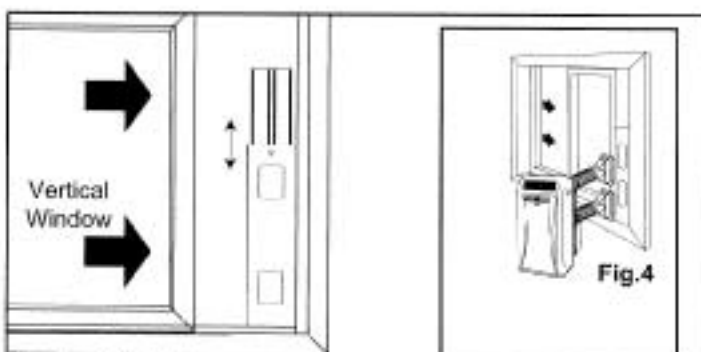
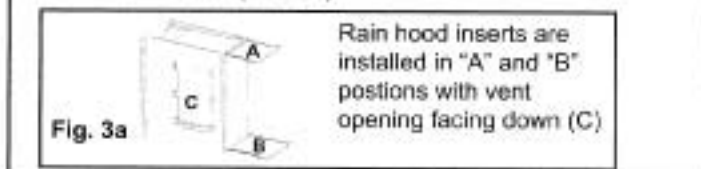

Window Slider Kit  
Minimum: 28" (71.1 cm)  
Maximum: 48 1/2" (123 cm)

Fig. 4

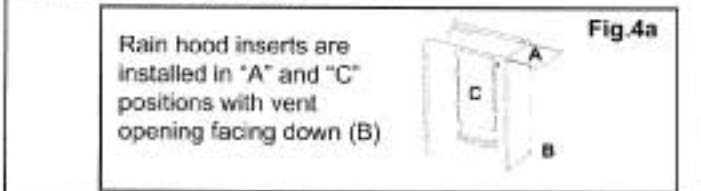

**Please Note:** In a vertical application, the exhaust hose **MUST** be positioned above the intake hose in the window slider. See Fig. 5. This will avoid having the exhaust heat go through the intake and back into the unit.

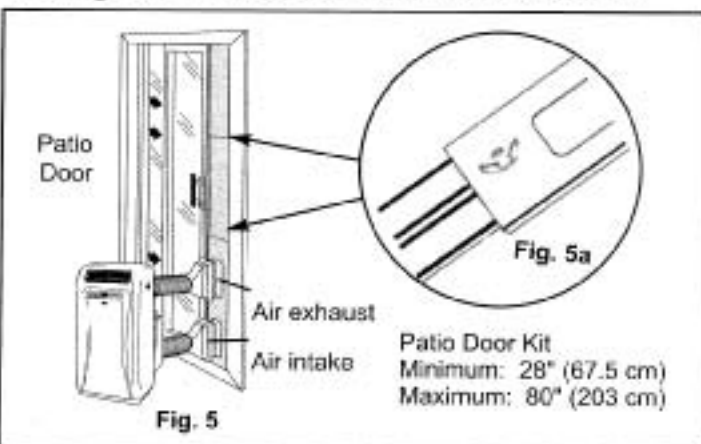

Fig. 5

Patio Door Kit  
Minimum: 28" (67.5 cm)  
Maximum: 80" (203 cm)

Plug the unit into a 115 V / 60 Hz grounded electrical outlet.



## Key Pad Functions



**I/O Power Switch:** Turns unit On / Off.

**MODE :** Allows you to scroll through and select desired operating mode.

**FAN :** Select from three different fan speeds; *Low, Medium and High*, during Cool and Fan mode. **Please note:** During 'Dry' mode there is only one fan speed utilized (*low*) .

**SWING :** Allows the vertical louver grills to oscillate from side to side automatically.

**TEMPERATURE /TIMER Adjust :**

**▲ :** Used to adjust Clock and Timer On/Off settings forward (1 min./1hr. increments).  
Used to adjust Temperature settings forward (1°C / °F increments).

**▼ :** Used to adjust Clock and Timer On/Off settings backward (1 min./1hr. increments).  
Used to adjust Temperature settings backward (1°C / °F increments).

**Note:** This appliance allows you select the temperature scale displayed in either "Celsius" or Fahrenheit" according to your preference.

To change temperature scale displayed on the control panel display, press both the "Temp/Timer" adjust arrows simultaneously to alternate between "Celsius" & "Fahrenheit".

**TIMER ON :** Used to initiate the **AUTO ON** start time.

**TIMER OFF:** Used to initiate the **AUTO OFF** stop time.

**CLOCK :** Allows you to initiate and/or change the "TIME OF DAY" setting. To activate clock mode both the **TIMER ON** and **TIMER OFF** buttons must be pressed simultaneously.

## Indicator Lights & Display Icons



**RUN:** Adjacent blue indicator light illuminates to indicate selected mode is operational.

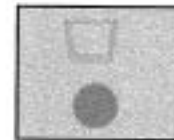

**WATER FULL :** A warning signal (beep) will sound and the adjacent red indicator light will **flash** continuously indicating the *internal reservoir* is full, and the *external tank* will need to be installed. See "Internal Safety Feature" on pg.5 for additional details.

### ICONS

#### MODE



Cool



Dry (Dehumid.)



Fan Only

#### FAN /SPEED



High



Medium



Low



Swing

#### OTHER



**External Bucket:** *Illuminates* (steady) when the external bucket is installed. When the external bucket icon as well as the Water Full *indicator light* (see above) begin to flash, this indicates that the *external bucket* is full and will need to be emptied.

#### TIME / TIMER



**Clock:** Illuminates when the time (hour) is being modified.



**Timer On:** Illuminates when the **auto-on** time (hour) is being defined.



**Timer Off:** Illuminates when the **auto-off** time (hour) is being defined.

## Setting TIME OF DAY (Clock) Instructions:

### NOTE: This is a 24:00 hour clock system

Push and hold the CLOCK (TIMER ON / TIMER OFF) key pads simultaneously **Fig A**. The clock symbol appears in the display and the minute "00" digits start flashing **Fig C**. Press the TEMP/TIMER  $\triangle$   $\nabla$  buttons **Fig B** until the correct time (in minutes) is displayed. Press either of the clock (TIMER ON / TIMER OFF) buttons. The hour "0" digit start flashing. Press the TEMP/TIMER  $\triangle$   $\nabla$  buttons until the correct (hour) time is displayed. When the correct time appears in the display, press the CLOCK (TIMER ON / TIMER OFF) key pads simultaneously. The colons (:) between the hour and minutes start flashing indicating the time of day is now set.

**Important Note:** Any interruption to the electrical power supply will automatically cancel the **TIME OF DAY** clock program. In the event this should happen, you will be required to re-set the clock program.

## Operating Instructions (Air Conditioning):

**NOTE: Both exhaust hoses must be installed and properly vented (outdoors) during air conditioning mode.**

- 1) Press the I/O (on/off) key pad to switch on the unit. **Fig D**.
- 2) Press the MODE key until the COOL symbol appears in the display window **Fig E**. Each depression of the MODE key will advance to a different mode setting (Auto-Cool-Dry-Fan).
- 3) Press the appropriate  $\triangle$   $\nabla$  (TEMP / TIMER/ADJ) keys to select a suitable operating temperature setting **Fig B**. Temperature settings are adjustable between 16°C (61°F) to 31°C (88°F). The set temperature will flash in the display window for approximately 5 seconds then automatically revert back to display actual room ambient temperature conditions. **NOTE:** The set operating temperature must be programmed within the 5 second (temperature flashing) condition. To view the "set" temperature any time, press either of the TEMP/TIMER ADJ buttons. The blue indicator light will come on indicating the air conditioning mode is operational (there may be a slight delay of 10-30 seconds before the cycle begins, this is normal).

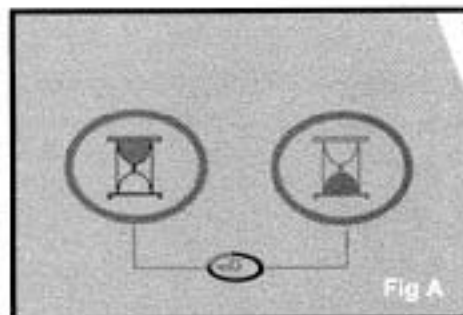

Fig A

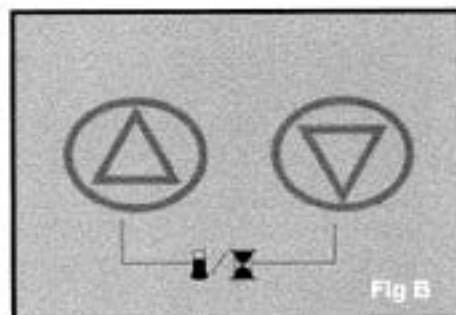

Fig B



Fig C

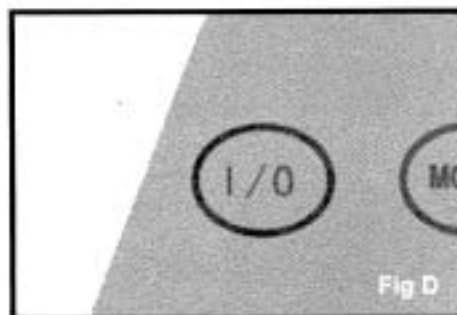

Fig D

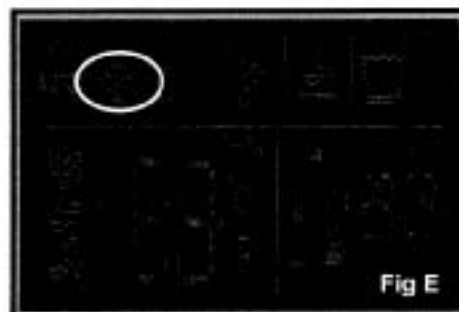
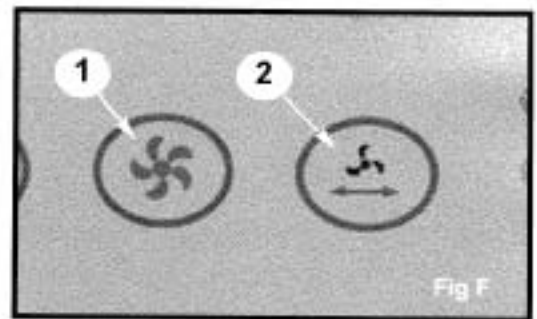

Fig E

## Air Conditioner Operating Instructions (cont'd)

- 4) Press the **FAN** key *Fig F (1)* to select the desired fan speed setting (**Auto-Low-Med-High**). Your selection will appear in the **display** window (each depression of the fan key will advance to a different setting).
- 5) Press the **SWING** key *Fig F (2)* to activate the automatic air swing (oscillating) feature and the swing symbol will appear in the display window. *Fig G*. To deactivate the air swing feature, press the **SWING** key again.
- 6) The horizontal louvers open and close automatically when the unit is switched on and off. To adjust "air flow" direction, (up / down only) adjust the center louver only up or down *Fig 16*.



The blue indicator light will come on indicating the air-conditioning mode is operational (there may be a slight delay of 10-30 seconds before the cycle begins, this is normal).

Cooling stops automatically when the set temperature is achieved. Cooling resumes when the room temperature rises above the set temperature level. The temperature has no effect on the fan operation. Therefore, the fan will operate continuously (after the compressor has cycled off) to maintain optimal temperature control.



**CAUTION**

During air conditioning and dehumidifying modes, if the compressor cycle is interrupted (unplugged, power failure, etc.) and reinstated immediately thereafter, (within 3-5 minutes) a "compressor protection circuit" is automatically self-activated. The compressor cannot operate during a "compressor protection" condition. (this is normal) It may take 3-5 minutes before the "protection circuit" self-deactivates.



**DO NOT ATTEMPT TO START THE UNIT (COMPRESSOR) DURING THIS PERIOD.** Upon reinstating power to the unit all previous settings (i.e. time, mode, fan speed, auto timed programs) are lost and will have to be re-entered.

**ATTENTION**



When the unit beeps and the (red) "water full" indicator light illuminates and flashes continuously, please (re)install the external water tank.

## DRY (Dehumidifier) Operating Instructions

**NOTE:** During dehumidifier mode, the exhaust hoses do not have to be vented outdoors but should remain attached to the unit. The external water tank must be installed during dehumidifier mode.

- 1) Press the **I/O** (on/off) key pad to switch on the unit.
- 2) Press the **MODE** key until the **DRY**  symbol (Dehumidifying) appears in the display window. Each depression of the **MODE** key will advance to a different mode setting (**Auto-Cool-Dry-Fan**).
- 3) Press the appropriate   (**TEMP / TIMER ADJ**) key to select a (relative humidity) operating setting between 35% ~ 90% RH (adjustable in increments of 5%)

*For continuous (non-stop) dehumidifier operation*

*press the   (TEMP / TIMER ADJ) key pad until the symbol "- -" appears in the display window.*

**NOTE:** The compressor will not cycle off during "continuous" mode.

The set relative humidity level will flash in the display window for approximately 5 seconds then automatically revert back to display actual room ambient relative humidity conditions. **NOTE:** The set operating RH level must be programmed within the 5 second (flashing) condition. To view the "set" relative humidity program any time, press either of the TEMP/TIMER ADJ buttons.

**NOTE:** There is no fan speed adjustment during dehumidifying mode. (the fan speed is factory set for "low")

The **blue (RUN)** indicator light illuminates indicating dehumidifying mode is operational (there may be a slight delay of 10-30 seconds before the cycle begins, this is normal).

**IMPORTANT:** The relative humidity setting selected should always be set a few degrees lower than the room ambient relative humidity conditions, to ensure normal dehumidifying operation. **NOTE: it is not recommended to operate your Dehumidifier, below temperatures of 15.5°C (60°F),** this could result in icing-up conditions of the evaporator coils, and minimize efficiency.

- 4) During 'Dry' mode when the external tank is full, the unit will alarm (**beep**) for **20 seconds** and the water full red **indicator light** will illuminate **and** the water full **icon in the control panel** will begin to flash continuously. At this time dehumidification will stop immediately. However, the fan motor will continue to operate (this is normal). Carefully remove the water tank from the cabinet, dispose of the water. Replace the water tank back to its original position and the Dehumidifying process will automatically resume. It may take 3-5 minutes for the compressor to re-start. This is normal.
- 5) This unit also has provisions for a continuous "drain" option (for basement applications having a floor drain). *The required drain hose is included with this unit.* Drain Hose Specifications: Standard garden hose. For continuous direct drain operation. Remove (unscrew) the drain cap at the back of the cabinet located directly above the external tank. Attach suitable length (of drain hose) to the direct drain fitting. (do not over tighten) Position the open end of the drain hose as close as possible to the floor drain. Check the hose connection for leaks.

**NOTE:** Direct drain operation is intended for floor drain applications only. Direct drain operation should not be used in stem pipe and/or sink applications.



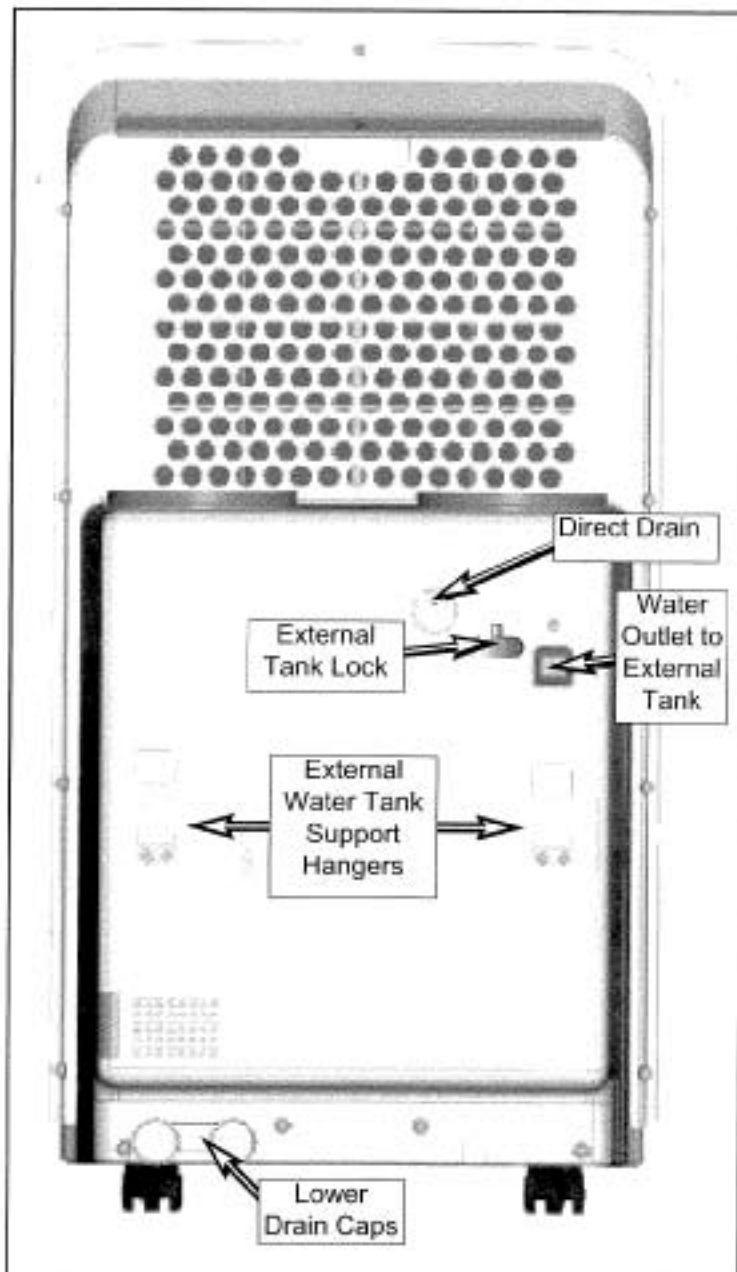

## CAUTION



During air conditioning and dehumidifying modes, if the compressor cycle is interrupted (unplugged, power failure, etc.) and reinstated immediately thereafter, (within 3-5 minutes) a "compressor protection circuit" is automatically self-activated. The compressor cannot operate during "compressor protection" mode. (this is normal) It may take 3-5 minutes before the "protection circuit" self-deactivates.

### **DO NOT ATTEMPT TO START THE UNIT (COMPRESSOR) DURING THIS PERIOD.**

Upon re-starting the unit (turn switch on) all program information (i.e. time, mode, fan speed, auto timed programs) will have to be re-programmed.



## IMPORTANT



If the unit will not be in use for a long period of time or is to be stored. Place a trip tray beneath the bottom drains (See Fig. 38) and remove the caps (one at a time) to manually release the water from the internal reservoir.

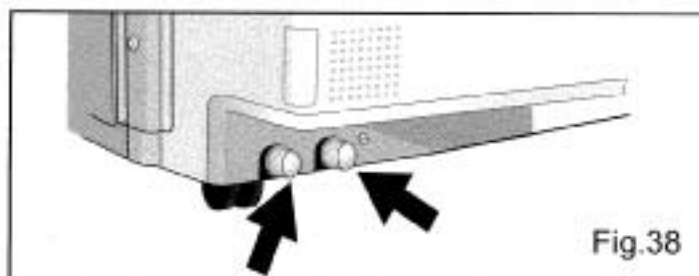

Fig.38

## Fan Operating Instructions

**NOTE: The exhaust hoses are not required during FAN only mode operation.**

**The external water tank is not required during FAN only mode operation.**

- 1) Press the **I/O** (on/off) key pad to switch on the unit. *Fig H*
- 2) Press the **MODE** key until the **FAN** symbol appears in the display window. Each depression of the **MODE** key will advance to a different mode setting (**Cool-Dry-Fan**). *Fig H*
- 3) Press the **FAN** key to select the desired **FAN SPEED** setting. Your selection will appear in the display window *Fig I*. Each depression of the fan key will advance to a different fan speed (**Low-Med-High**).
- 4) Press the **SWING** key to activate the automatic air swing (oscillating) feature (the air swing symbol will appear in the display window) *Fig J*. To deactivate the air swing feature, press the **SWING** key again.
- 5) To adjust "air flow" direction, (up / down only) adjust the center **Horizontal Louver Blade** and the remaining louvers will automatically adjust to the same position. *Fig. 25*

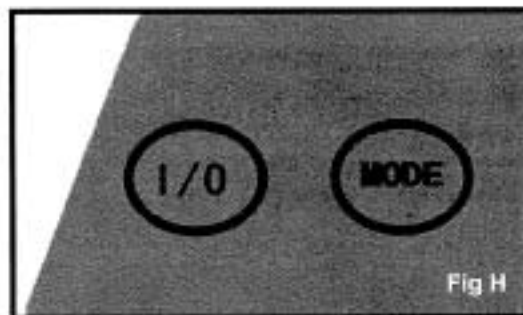

Fig H

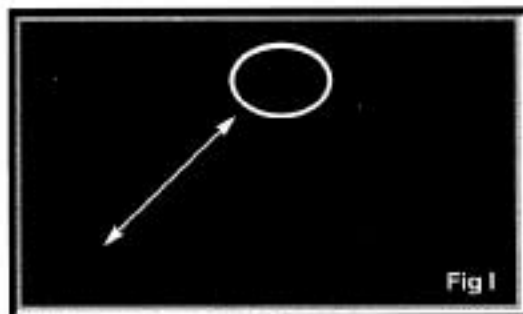

Fig I

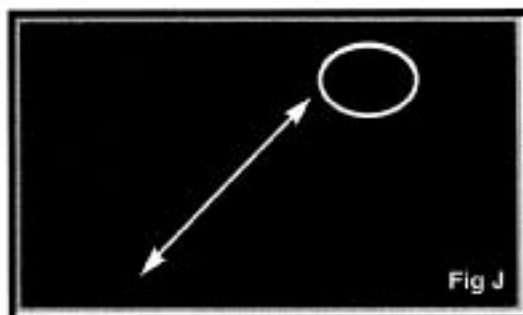

Fig J



Fig. 25

## Auto-Timer Instructions

The AUTO-TIMER feature offers a unique selection of multiple choice, fully automatic on/off (start/stop) programs between 0 - 23 hrs, 59 min. under any one mode of your Portable 3 Season Home Comfort unit. The programs are as follows:

- a) **Auto -Off:** Pre-select a time that will turn off the unit (automatically) at a specified time (between 0 - 23 hrs, 59 min.). This function must be performed daily, as the program is automatically canceled/erased after the program has ended.
- b) **Auto-On:** Pre-select a time that will turn on the unit (automatically) at a specified time (between 0 - 23 hrs, 59 min.). This function must be performed daily, as the program is automatically canceled/erased after the program has ended .
- c) **Auto-On & Auto-Off:** Pre-select a time that will turn the unit ON / OFF (automatically) at specified times (between 0 - 23 hrs, 59 min.). Unlike programs a) and b) above, this program contains a built-in memory that automatically stores into memory the selected times and will repeat daily, (same specified times) until the program is overridden and/or canceled. However, any interruption in electrical power will automatically cancel/erase all **auto timed** programs. In the event this should happen, you will be required to re-program your settings.

## Setting the AUTO-ON TIMER

Before setting the **AUTO-ON** timer, the **TIME OF DAY CLOCK** must be set/operational. You must select all appropriate settings (i.e. **MODE**, **FAN SPEED**, **TEMP**, **HUMIDITY**, **SWING** etc.) required to operate under the **AUTO TIMED** program before initiating the **AUTO-ON** program.

- 1) Select the appropriate **MODE** under which you want the unit to operate (**Auto-Cool-Dry-Fan**).
- 2) Select the appropriate **FAN SPEED** setting, under which you want the unit to operate. (**Auto, Hi, Med, Low**) (excluding **Dehumidifying**, as this mode has "1" fan speed setting only).
- 3) Select **SWING (oscillation)** by pressing the **SWING** key pad (the 'swing' symbol will appear in the display window).

### Setting the AUTO-ON TIMER (cont'd)

- 4) All of the settings are now registered.
- 5) To set the **AUTO-ON** timer, the unit must be turned "off" (non-operational).
- 6) Press the **TIMER-ON** key pad (**Fig K**) to initiate the **AUTO-ON** time sequence. The "TIMER-ON" icon (**Fig L**) will appear in the display window and the minute digits start to flash. Press either  $\Delta$  or  $\nabla$  TEMP/TIME keys (**Fig M**) to select the AUTO-ON "minutes". Press the TIMER-ON key pad again and the "hour" digits start to flash. Press the  $\Delta$  or  $\nabla$  TEMP/TIME ADJ key pad to select the AUTO-ON "hour" start time. Press the TIMER-ON key pad again and the display will stipulate, CLOCK / ON / and the set AUTO-ON time. Press the clock buttons (TIME-ON / TIMER-OFF) simultaneously to revert back to the current time of day clock setting. -The unit will start automatically at the specified **AUTO-ON** set time. To cancel or override the **AUTO-ON** program, simply turn on the unit anytime prior to the **AUTO-ON** time is scheduled to operate. You can vary the **AUTO-ON** time selected anytime (prior to the program starting) by pressing the **TIMER-ON** key pad. The time you selected will appear in the display.

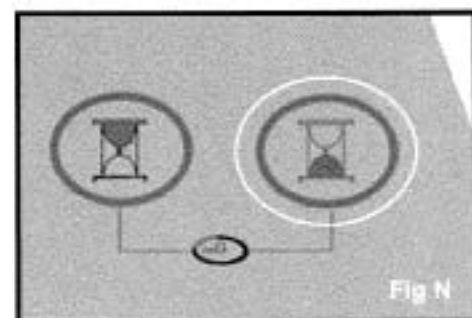
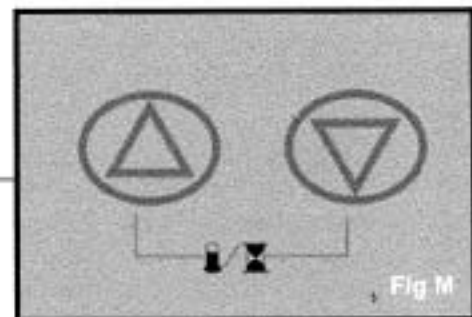
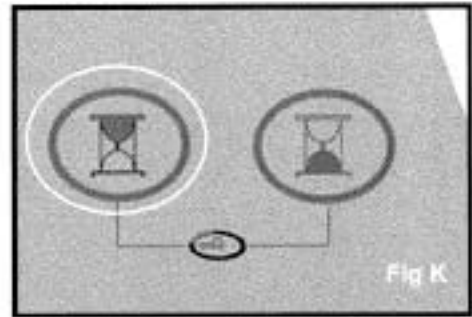

### Setting the AUTO-OFF TIMER

Before setting the **AUTO-OFF** timer, the **time of day clock** must be set/operational.

- 1) To set the **AUTO-OFF** timer, the unit must be (operational) turned on. (I/O switch)
- 2) Press the **TIMER-OFF** key pad (**Fig N**) to initiate the **AUTO-OFF** time sequence. **TIMER-OFF** will appear in the display window (**Fig O**) and the "minute" digits start to flash. Press the  $\Delta$  or  $\nabla$  key pad to select the **AUTO-OFF** "minute" time. Press the **TIMER-OFF** key pad again and the "hour" digits start to flash. Press the  $\Delta$  or  $\nabla$  TEMP/TIME ADJ key pad (**Fig M**) to select the **AUTO-OFF** "hour" stop time. Press the **TIMER-OFF** key pad again to the set **AUTO-OFF** time. Press the clock buttons (TIMER-ON / TIMER-OFF) simultaneously to revert back to the current time of day clock setting. The unit will stop automatically at the specified **AUTO-OFF** time. To cancel or override the **AUTO-OFF** program, simply turn off the unit anytime prior to the **AUTO-OFF** time is scheduled to operate.

You can vary the **AUTO-OFF** time selected anytime (prior to program ending) by pressing the **TIMER-OFF** key pad. The time you selected will appear in the display.



### Setting the AUTO-ON & AUTO-OFF timer during the same program.

Before setting the **AUTO-ON & AUTO-OFF Timer**, the **time of day clock** must be set/operational. You must select all appropriate settings (i.e. **MODE**, **FAN SPEED**, **TEMP**, **HUMIDITY**, **SWING** etc.) required to operate under the **AUTO TIMED** program before initiating the program.

- 1) Select the appropriate **MODE** under which you want the unit to operate (**Auto-Cool-Dry-Fan**).
- 2) Select the appropriate **FAN SPEED** setting, under which you want the unit to operate. (**Auto**, **Hi**, **Med**, **Low**) (excluding **Dehumidifying**, as this mode has "1" fan speed setting only).
- 3) Select **SWING** (oscillation) by pressing the **SWING** key pad and the "air swing" symbol will appear in the display window.
- 4) Press the **TIMER-ON** key pad (*Fig P*) to initiate the **AUTO-ON** time sequence. **TIMER-ON** will appear in the display window (*Fig Q) and the "minute" digits start to flash. Press either **TEMP** / **TIME** keys (*Fig R*) to select the **AUTO-ON** "minutes". Press the **TIMER-ON** key pad again and the "hour" digits start to flash. Press the  $\Delta$  or  $\nabla$  **TEMP/TIME ADJ** key pad to select the **AUTO-ON** "hour" start time. Press the **TIMER-ON** key pad again to set the **AUTO-ON** time.*
- 5) Press the **TIMER-OFF** key pad (*Fig S*) to initiate the **AUTO-OFF** time sequence. **TIMER-OFF** will appear in the display window (*Fig T*) and the "minute" digits start to flash. Press the  $\Delta$  or  $\nabla$  **TEMP/TIME ADJ** key (*Fig R*) pad to select the **AUTO-OFF** "minute" time. Press the **TIMER-OFF** key pad again and the "hour" digits start to flash.

Press the  $\Delta$  or  $\nabla$  **TEMP/TIME ADJ** key pad to select the **AUTO-OFF** "hour" stop time. Press the **TIMER-OFF** key pad again to set the **AUTO-OFF** time and the current time of day will appear in the display window. The unit will now "start" and "stop" automatically at the specified **AUTO-ON / AUTO-OFF** times.

You can verify the selected **AUTO-ON / AUTO-OFF** times by pressing the **TIMER-ON / TIMER-OFF** key pad. The time you selected will appear in the display.

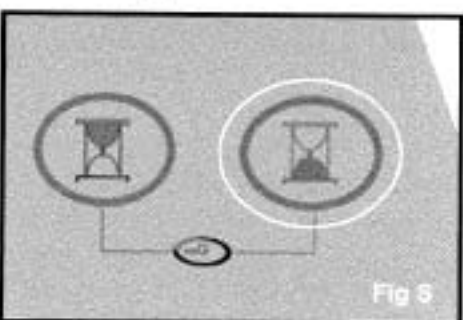
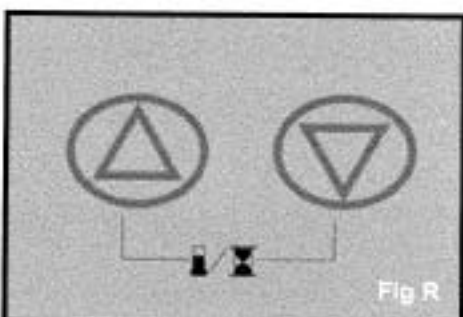
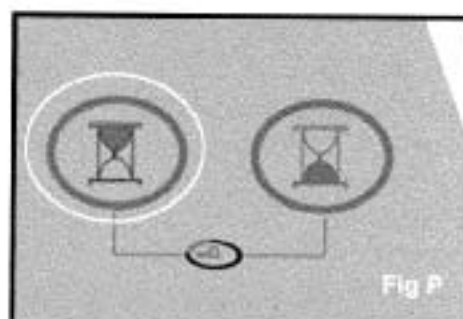

## Remote Control Features

The hand held remote unit allows you to control all operational aspects of your Portable 3 Season Home Comfort Appliance from the convenience of your favorite armchair. Here are some things you should know about operating the unit with the hand held remote.

### Control Buttons

**I/O:** Power switch (On/Off).

**Mode:** Selects the operating mode (Auto/Cool/Dry-Dehumidifier/Fan).

Note "Auto" mode is a pre-set factory mode inclusive of a set operating temperature of 24C (75F). Under AUTO mode the unit will alternate between appropriate modes, COOL, DRY, FAN, to maintain internal environment conditions at the pre-set 24C (75F) temperature conditions.

 **Fan:** Selects fan speed settings (Auto-LOW-MED-HIGH).  
*NOTE:* The "Auto" fan speed setting is equivalent to "Medium" fan speed.

+  Used to adjust (increase) temperature settings. (1° increments) on the Celsius or Fahrenheit scale.

-  Used to adjust (decrease) temperature settings. (1° increments) on the Celsius or Fahrenheit scale.

 **SWING:** Used to activate the vertical louver (oscillation) auto swing from side to side.

 **SLEEP:** Used to activate the SLEEP program.

 **T-ON:** Used to activate the TIMER-ON program.

 **T-OFF:** Used to activate the TIMER-OFF program.

 **HOUR:** Used to program the HOUR time.

 **MIN:** Used to program the MINUTE time.

 **RESET:** Used to reset all remote control programs.

## CAUTION

"DO NOT MIX OLD AND NEW BATTERIES" or "DO NOT MIX ALKALINE, STANDARD (CARBON-ZINC) OR RECHARGEABLE (NICKEL-CADMIUM) BATTERIES".



To operate the hand held remote control will require two "AAA" Alkaline batteries (included).

### Batteries should be replaced when:

- No signal (beep) is heard when attempting to program the main unit.
- The main unit does not respond to a command issued by the remote control.

### Battery replacement:

- Slide the rear cover on the remote in the direction of the arrow. Continue pulling (gently) until the cover separates completely from the unit.
- Insert (2) batteries (AAA) following the same orientation (polarity) depicted inside the battery chamber.(+/-)
- Re-install rear cover.
- If the remote control will not be used for extended periods of time (vacations etc.), batteries should be removed.

The remote operates within a range of 7 meters (23 ft.) from the receiver located inside the main unit. Any obstruction between the receiver and remote may cause signal interference, limiting the ability to program the main unit.

**NOTE:** The (illuminated) back-lit key pads on the main unit control panel will not illuminate when settings are made using the remote control unit. (this is normal)

## Remote Control Operating Instructions

- 1. Sending Signal:** The remote control must be aimed directly at the infra-red eye located below control panel when initiating a command. When the remote control is switched on and a button is pressed, a beep will sound (main unit) confirming a signal was sent/received. All program selections appearing in the remote control display will appear in the display of the main unit when both units are operational. If the main unit does not respond to the command issued, try the procedure again. If the main unit again fails to respond;

### Check the following:

- Are the receiver and the remote unit within the required 7 meter (23 ft.) operating distance?
- Is the receiver window on the main unit partially blocked and/or obscured?
- Are the batteries correctly installed inside the remote (positive+ / negative-)?
- Check the batteries. If low, replace.

- 2. Setting/Adjusting Time of Day Clock**

**(Remote Control):** When the batteries are first installed, the clock display flashes "0:00". Press the M (minute) button to set the correct time in minutes. Each time the M button is pressed the time is increased in 10 minute increments. The time sets automatically (stops flashing) after 5 seconds. Press/hold the H (hour) button to select/change the correct hour time. (time flashes) Each time the H button is pressed the time will increase in 1 hour increments. The time automatically sets (stops flashing) after 5 seconds. When the main unit is switched on using the remote control, the time on the main unit will automatically adjust to the time set on the remote control.

- 3. Mode Setting:** Press the "Mode" button to select operating mode. Each time the button is pressed will advance to a different setting i.e Auto-Cool-Dry-Fan.

### MODE ICONS

❄️ COOL    🌀 FAN    💧 DRY

- 4. Temperature Setting:** Press the remote buttons to select the desired operating temperature. Each time a button is pressed the temperature will increase/decrease 1°C/F. The temperature selected will appear in the remote display. When the main unit is switched on using the remote control, the temperature on the main unit will automatically adjust to the temperature set on the remote control. Temperature ranges from 16°C-31°C (60.8°F - 88°F)

- 5. Fan Speed Setting:** Press the  "Fan" button to select the operating fan speed. Depending on the mode selection, the fan button will advance to a different fan speed (Auto-Low-Medium-High) The fan speed selected will appear in the display window.

### FAN SPEED ICONS

 LOW     MEDIUM     HIGH

MODE	AVAILABLE FAN SPEEDS
Cool	Low-Medium-High
Dry	Low
Fan	Low-Medium-High
AUTO	Low-Medium-High

### LCD Window

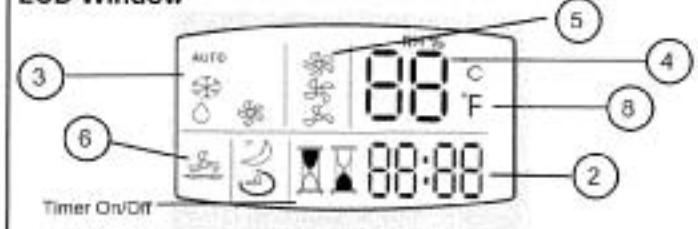

## Remote Control Operating Instructions (cont'd)

6. **Swing:** Press the  "Swing" button to activate the automatic air swing (oscillation) feature. The swing symbol will appear in the display window confirming the "swing" feature is activated. To deactivate the "swing" feature, press the swing button again.
7. **RESET:** Using a narrow object (e.g. pencil), depress the recessed "R" button to cancel all remote control programs. This will erase "all" information contained within the remote control display window (including time of day clock setting).
8.  $\Delta \nabla$  C & F: Press either of the temperature buttons to select (increase / decrease) operating temperatures. Press both buttons simultaneously to switch from "Celsius" to "Fahrenheit".
9. **SLEEP:** NOTE: The sleep mode feature can only be programmed using the hand held remote control.

The sleep mode allows you to program a set cooling temperature that will gradually increase the set operating temperature "+0.5°C / 0.9° F" (during night time sleeping hours) resulting in less compressor running time saving energy consumption and preventing the room from becoming too cold during sleeping hours. See the table below for temperature differentials during an 8 hour period.

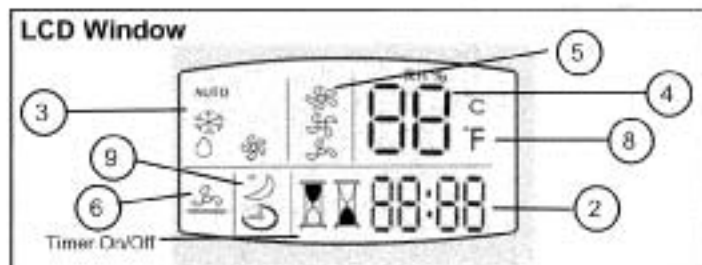

### EXAMPLE:

Time Period (Operation) (Above Set Temperature)	Temperature Increase
1st Hour	+0.5°C
2nd Hour	+0.5°C
3rd Hour	+0.5°C
4th Hour	+0.5°C
5th Hour	+0.5°C
6th Hour	+0.5°C
7th Hour	+0.5°C
8th Hour	Automatically returns to Set Operating Temperature

1) Press the  "Sleep" button on the remote control.

2) The set temperature will appear in the display window of the remote.

3) Press the  $\Delta \nabla$  temperature buttons to select the required "set" operating temperature.

4) The unit is now programmed for sleep mode

**NOTE:** When turning off the main unit with the remote control, there may be a delayed (off) reaction (5-15 seconds) before the unit actually stops. This is normal.



## Care and Maintenance



### CAUTION



Before cleaning or servicing this unit, it is recommended that the unit be disconnected from any electrical supply outlet.

- 1) **Do Not** use gasoline, benzene, thinner or any other chemicals to clean this unit, as these substances may cause damage to the finish and deformation of plastic parts.
- 2) **Never** attempt to clean the unit by pouring water directly over any of the surface areas, as this will cause deterioration of electrical components and wiring insulation.

### Removal and Cleaning of the Air Filters

If the air filters become clogged with dust/dirt, air flow is restricted and reduces cooling efficiency. The air filters should be cleaned every two (2) weeks. More frequent cleaning may be necessary depending upon air quality. **NOTE:** The air filter (*filter 1*) is located at the (upper) rear side of the unit. In order to access the air intake filter (*filter 2*), the air intake hose and collar will have to be removed.

- 1a) To remove the air filter (Fig. 34): Pull the air filter upward in the direction of the arrow.
  - 1b) To remove the air *intake* filter (Fig. 35): Simply tilt the filter handle upwards and pull out the filter basket. (Fig. 36).
- 2) Dust/Dirt clogged in the filter can be removed by vacuum cleaning the soiled areas.
  - 3) The filter can also be washed in lukewarm soapy water while rubbing it lightly with a brush. A mild detergent (dishwashing soap) is recommended.
  - 4) Rinse the filter well using clean water. Allow time to dry before reinstalling into the unit.
  - 5) Replace the air filters.
  - 6) Replacement air filters are available through the Customer Service Parts Department.

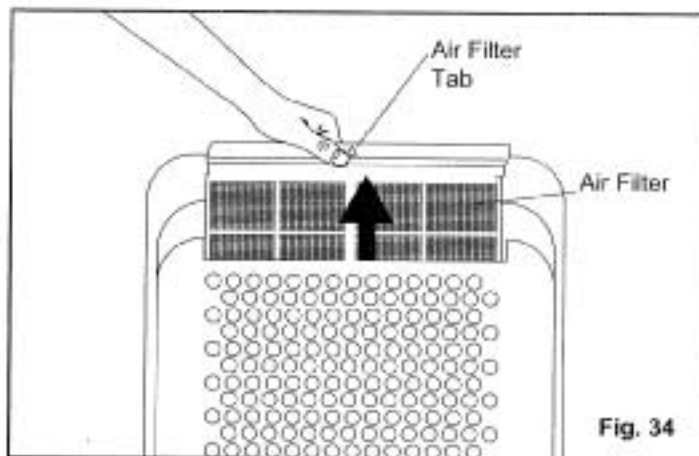

Fig. 34

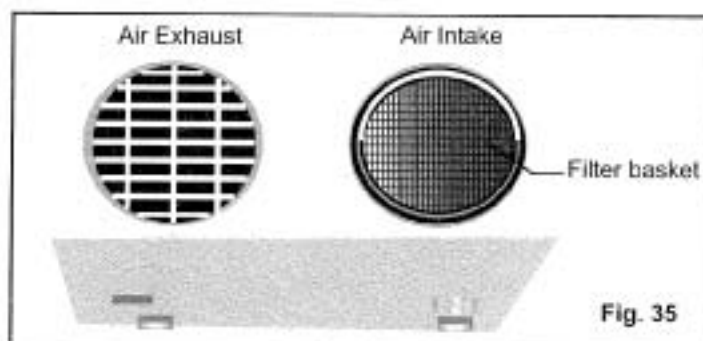

Fig. 35

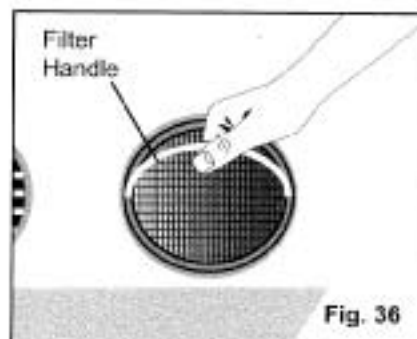

Fig. 36



### CAUTION



Never operate the unit without the air filters in place as this may result in damage to the unit.

# Danby®

## LIMITED AIR CONDITIONER WARRANTY

This quality product is warranted to be free from manufacturer's defects in material and workmanship, provided that the unit is used under the normal operating conditions intended by the manufacturer.

This warranty is available only to the person to whom the unit was originally sold by Danby or by an authorized distributor of Danby, and is non-transferable.

### TERMS OF WARRANTY

Plastic parts, are warranted for thirty (30) days only from purchase date, with no extensions provided.

- First 12 Months** During the first twelve (12) months, any electrical parts of this product found to be defective, including any sealed system units, will be repaired or replaced, at warrantor's option, at no charge to the ORIGINAL purchaser.
- Additional 48 Months** During the next forty-eight (48) months any part of the sealed system found to be defective (consisting of compressor, condenser, evaporator, dryer and all related tubing) will be replaced without charge. The purchaser shall pay for all labor and return freight) during this period for repair or replacement of any sealed system components. Any unit being diagnosed as non-functional due to sealed system failure and warranting an exchange will be subject to an appropriate depreciation or user fee, including any and all freight charges being levied against the consumer.
- To obtain Service** Danby reserves the right to limit the boundaries of "In Home Service" to the proximity of an Authorized Service Depot. Any appliance requiring service outside the limited boundaries of "In Home Service", it will be the consumer's responsibility to transport the appliance (at their own expense) to the original retailer (point of purchase) or a service depot for repair. Contact your dealer from whom your unit was purchased, or contact your nearest authorized Danby service depot, where service must be performed by a qualified service technician. If service is performed on the units by anyone other than an authorized service depot, or the unit is used for commercial application, all obligations of Danby under this warranty shall be at an end.

### EXCLUSIONS

Save as herein provided, Danby Products Limited (Canada) or Danby Products Inc. (U.S.A.), there are no other warranties, conditions, representations or guarantees, express or implied, made or intended by Danby Products Limited or its authorized distributors and all other warranties, conditions, representations or guarantees, including any warranties, conditions, representations or guarantees under any Sale of Goods Act or like legislation or statute is hereby expressly excluded. Save as herein provided, Danby Products Limited (Canada) or Danby Products Inc. (U.S.A.), shall not be responsible for any damages to persons or property, including the unit itself, howsoever caused or any consequential damages arising from the malfunction of the unit and by the purchase of the unit, the purchaser does hereby agree to indemnify and save harmless Danby Products Limited from any claim for damages to persons or property caused by the unit.

### GENERAL PROVISIONS

No warranty or insurance herein contained or set out shall apply when damage or repair is caused by any of the following:

- 1) Power Failure.
- 2) Damage in transit or when moving the appliance.
- 3) Improper power supply such as low voltage, defective house wiring or inadequate fuses.
- 4) Accident, alteration, abuse or misuse of the appliance such as inadequate air circulation in the room or abnormal operating conditions (extremely high or low room temperature).
- 5) Use for commercial or industrial purposes.
- 6) Fire, water damage, theft, war, riot, hostility acts of God such as hurricanes, floods etc.
- 7) Service calls resulting in customer education.

Proof of purchase date will be required for warranty claims; so, please retain bills of sale. In the event warranty service is required, present this document to our AUTHORIZED SERVICE DEPOT.

Warranty Service

In Home on Models 6,000 BTU or Greater

Danby Products Limited  
PO Box 1778, 5078 Whiteley RD, Guelph, Ontario, Canada N1H 6Z9  
Telephone: (519) 837-0520 FAX: (519) 837-0448

Danby Products Inc.  
PO Box 688, 101 Bentley Court, Findlay, Ohio, U.S.A. 45833-0669  
Telephone: (419) 425-8627 FAX: (419) 425-8629

# Danby®

Model • Modèle

**DPAC90061**

**DPAC11007**

For service, contact your nearest  
service depot or call:

**1-800-26-DANBY**

**(1-800-263-2629)**

to recommend a depot in  
your area.

Pour obtenir le service,  
consultez votre centre de service le  
plus rapproché ou composez le :

**1-800-26-DANBY**

**(1-800-263-2629)**

qui vous recommandera un centre r  
régional.

# Danby®

## Portable 3 Season Home Comfort

The model number can be found on the serial plate located on the back panel of the unit.

All repair parts available for purchase or special order when you visit your nearest service depot. To request service and/or the location of the service depot nearest you, call the TOLL FREE NUMBER.

When requesting service or ordering parts, always provide the following information:

- Product Type
- Model Number
- Part Number
- Part Description

## Appareil de confort au foyer portable 3 saisons

Le numéro de modèle se trouve sur la plaque d'information sur le panneau arrière de l'appareil.

Toutes les pièces de rechange ou commandes spéciales sont disponibles à votre centre de service régional autorisé. Pour obtenir le service et/ou la localité de votre centre de service régional, signalez le NUMÉRO D'APPEL SANS FRAIS.

Ayez les renseignements suivants à la portée de la main lors de la commande de pièce ou service :

- Type de produit
- Numéro de modèle
- Numéro de pièce
- Description de la pièce

Danby Products Ltd, PO Box 1778, Guelph, Ontario Canada N1H 6Z9

Danby Products Inc, PO Box 669, Findlay, Ohio USA 45839-0669