

PACKAGED TERMINAL AIR CONDITIONERS

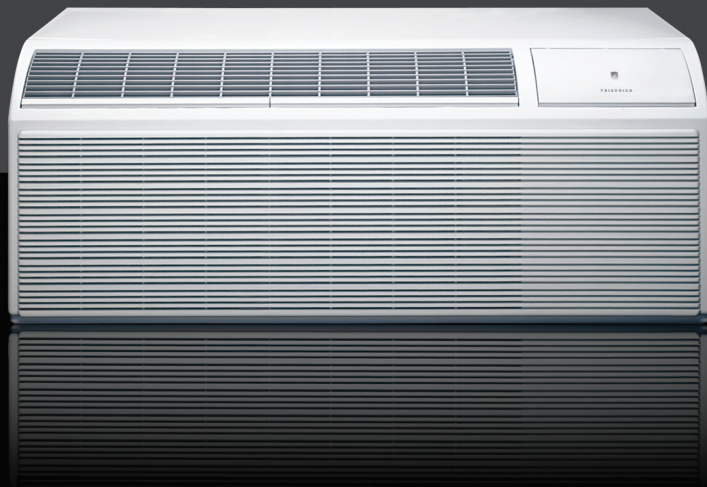

F R I E D R I C H

1 8 8 3



DIGITAL CONTROLS. LOADED with OVER 40 STANDARD FEATURES.

Standard features often only found on the premium models of other brands

Electronic temperature limiting

Owners and operators will appreciate the flexibility to set separate heat and cool range limits.

Constant comfort room monitoring

The digital control panel will automatically run the fan to briefly sample the room temperature every nine minutes to ensure desired conditions are maintained.

Desk control ready

Allows hotel owners to control units from a central location.

Auxiliary fan ready

Allows multiple rooms to share one unit.

Remote thermostat operation

Control Friedrich units using either a wall-mounted thermostat, remote control or built-in controls.

"Instant Heat" heat pump mode

Instant heat quickly heats a room to the desired temperature for increased comfort.

Remote control operation

New remote control lets user operate with more convenience (remote control is an optional accessory).

Even heat monitoring

Checks room temperature and automatically adds heat boost if necessary.

Random compressor restart

Protects electrical systems from overload when power is restored.

High efficiency

Reduces your operating costs.

Room freeze protection

Heat initiated if temperature falls to 40°F in an unoccupied room, raising temperature to 46°F.

Filtered fresh air intake

Ideal for applications where indoor air quality is important.

Fan cycle control

Select fan cycling or continuous fan operation for more comfort options.

Electronic defrost control

Ensures more run time in the efficient heat pump mode.

Whether you order 1 or 100 units, each unit is individually palletized to reduce the risk of shipping damage.



DIGITAL CONTROLS

Large, easy-to-read LED display for precise temperature control and energy savings.

ANTIMICROBIAL AIR FILTERS

Top-mounted for quick access. Easy to clean. Antimicrobial protection against fungal and bacterial growth.

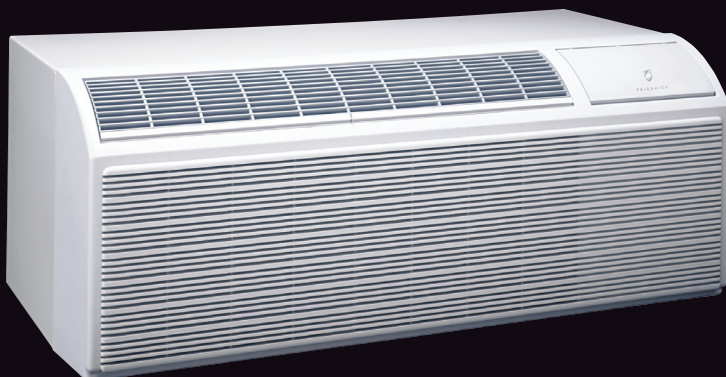

Ultraquiet design

Ultraquiet air system

Moves the air very quietly and efficiently. Low/sleep setting is noticeably quieter than other popular brands.

Quiet start/stop fan delay

We developed a soft start/stop feature that reduces transitional noise that is usually associated with compressor start-up.

Quiet, efficient rotary compressor

Mounted with vibration isolators to keep the compressor running smoothly and quietly.

Fits other PTAC sleeves without a baffle kit.

IMPORTANT NOTE: Sleeves are sold and shipped separately to accommodate new construction and replacement requirements.

Designed for a longer product life

Durable design

Tamper-resistant grille, enclosed clamshell motor and dual thumb-screws are just some of the features that Friedrich engineers added for a longer product life.

Powder coat paint process

Durable, powder coat paint finish.

Aluminum endplates

Corrosion-resistant construction for longer life.

Indoor coil frost sensor

Protects the compressor to lengthen the life of the unit.

Easy serviceability

Single motor design

Fewer parts to maintain.

Service error code storage

Error code memory facilitates improved unit diagnostics.

Top-mounted antimicrobial air filters

Quick and easy access. Easy to clean. Protection from fungal and bacterial growth.

Emergency heat override

Ensures heat mode operation even in the unlikely event of compressor failure.



250 V Receptacles and Fuse Types			
AMPS	15	20	30
HEATER SIZE	0, 2.5 kW	3.4 kW	5.0 kW
RECEPTACLE			

Packaged Terminal Air Conditioner Model Identification Guide

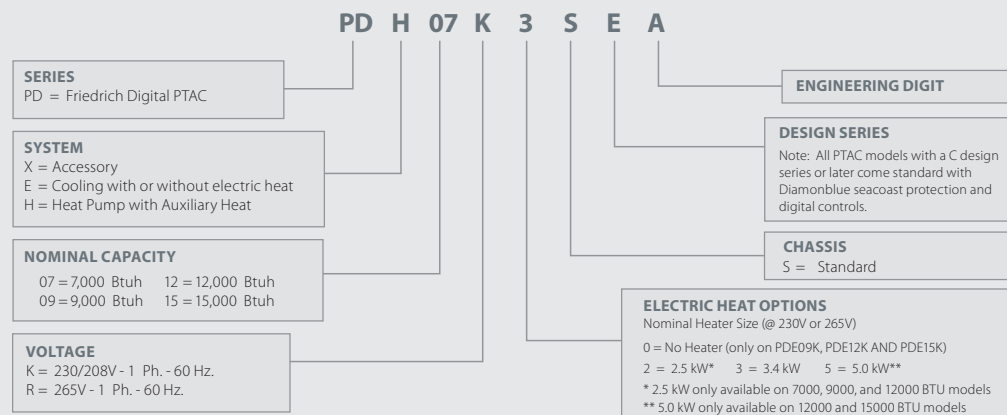

Loaded with over 40 standard features. It's like a free upgrade over standard PTACs.



REMOTE CONTROL

Optional accessory for added guest comfort. Ideal for ADA compliant rooms and properties with guest satisfaction programs.

REMOTE THERMOSTAT READY

Operates with optional Friedrich digital remote thermostat for user convenience.



STANDARD ON ALL MODELS.
This advanced corrosion protection treatment protects the outdoor coil against deterioration and extends the life of the unit especially in harsh coastal environments.

R-410A



All models use environmentally friendly R-410A refrigerant.



5 YEAR WARRANTY
On the sealed refrigeration system. Limitations apply. Refer to warranty documentation for details.

PTAC optional accessories

WALL SLEEVE PDXWS

Galvanized steel is prepared in a state-of-the-art, multistep process for stronger paint adhesion, then powder coated with a polyester finish and cured in an oven for exceptional durability. The wall sleeve is insulated for thermal efficiency. 16" x 42" x 13 3/4"

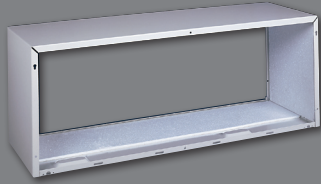

STANDARD GRILLE PXGA

Standard, stamped, anodized aluminum to resist chalking and oxidation.



DEEP WALL SLEEVE EXTENSION PXWE

A four-inch deep, anodized aluminum extension that attaches to the outside of the wall sleeve when the wall is greater than 13 1/4 inches thick (11 3/4" when a subbase is used, and 12 1/4" when a lateral duct is used).

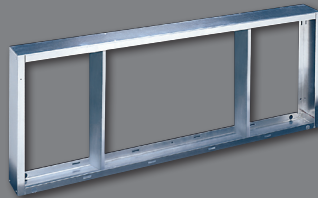

DIGITAL REMOTE THERMOSTATS

RT4 Digital, single stage thermostat. Hard wired with single speed fan.



RT5 Digital, single stage thermostat features high/low fan speed switch. Thermostat is hard wired and can be battery powered or unit powered. Features backlit display and multiple configuration modes. Mounts to wall for control of unit.



REMOTE THERMOSTAT ESCUTCHEON KIT

PDXRT

Kit contains ten escutcheons that can be placed over the factory control buttons when a remote wall mounted thermostat is used. The escutcheon directs the guest to the wall thermostat for operation and retains the LED window to display error codes and diagnostic information.



REMOTE CONTROL

PDXRC

One hand-held remote for control of PTAC unit. 2008 models and later only.



SLEEVE EXTENSION RETROFIT KIT

PXSE

2 1/4" sleeve extension attached to the room side of the sleeve to allow for the installation of a PD-series Friedrich PTAC in a 11 1/2" deep T-series sleeve.

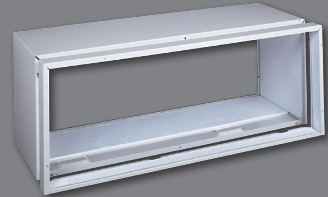

ARCHITECTURAL GRILLES

Architectural grilles that consist of heavy gauge 6063-T5 aluminum alloy

PXAA Clear extruded aluminum.
PXBG Beige acrylic enamel.
PXSC Available in custom colors.

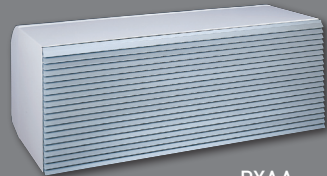

PXAA

DECORATIVE SUBBASE

PXSB

Provides unit support for walls less than six inches thick. Includes leveling legs, side filler panels and mounting brackets for electrical accessories. Accepts circuit breaker, power disconnect switch and conduit kit.



CONDENSATE DRAIN KIT

PXDR10

Attaches to the bottom of the wall sleeve for internal draining of condensate or to the rear wall sleeve flange for external draining. Recommended for all units to remove excess condensate. Packaged in quantities of ten.



CONDUIT KIT WITH JUNCTION BOX

PXCJ

Hard wire conduit kit with junction box for 208/230V and 265V units (subbase not required). Kit includes a means of quick disconnect for easy removal of the chassis.

*Required for 265V installations.



POWER CORD RETROFIT

PXPC 15/20/30

Replaces LCDI power cord on 230V models when unit is used with a subbase. PXPC15 is used with 15 amp (0 kW and 2.5 kW) units. PXPC20 is used with 20 amp (3.4 kW) units. PXPC30 is used with 30 amp (5.0 kW) units.



PDE Series Air Conditioner with Electric Heat - Cooling Performance

MODEL	PDE07K	PDE07R	PDE09K	PDE09R	PDE12K	PDE12R	PDE15K	PDE15R
PERFORMANCE DATA:								
Cooling BTUh	7500/7300	7500	9000/8800	9000	11500/11300	11500	14000/13800	14000
EER	11.6	11.4	11.4	11.0	10.2	10.1	9.3	9.3
Dehumidification (pints/hr)	1.7	1.6	3.4	3.3	2.9	2.8	3.8	3.8
ELECTRICAL DATA:								
Voltage (1 PHASE, 60 Hz)	230/208	265	230/208	265	230/208	265	230/208	265
Current (AMPS)	3.3/3.4	2.9	3.6/3.9	3.3	5.5/5.8	4.6	7.0/7.4	6.4
AMPS L.R.	13.0	15.0	19.8	16.8	27.0	23.0	32.0	27.0
AMPS F.L.	2.9	2.6	3.7	3.2	5.0	4.0	6.3	5.6
AIRFLOW DATA:								
Indoor CFM, HIGH	220	245	220	210	325	315	310	340
Indoor CFM, LOW	200	200	200	200	260	260	280	280
Vent CFM	60	60	60	60	70	70	70	70
PHYSICAL DATA:								
Dimensions	16x42x13.5	16x42x13.5	16x42x13.5	16x42x13.5	16x42x13.5	16x42x13.5	16x42x13.5	16x42x13.5
Net weight (lbs)	105	105	112	112	120	120	125	125
Shipping weight (lbs.)	125	125	132	132	140	140	145	145
R-410A charge (oz.)	42	35	36	35	33	35	48	42

PDH Series Heat Pump - Heating/Cooling Performance

MODEL	PDH07K	PDH07R	PDH09K	PDH09R	PDH12K	PDH12R	PDH15K	PDH15R
PERFORMANCE DATA:								
Cooling BTUh	7300/7100	7200	8500/8300	8500	11500/11300	12000	14000/13800	14000
EER	11.1	11.1	10.8	10.5	9.8	9.7	9.2	9.2
Reverse Heating BTUh	6400	6300	8000	7700	10500	10500	12800	12800
Power (WATTS) HEAT	625	615	781	752	1025	1025	1250	1250
COP	3.0	3.0	3.0	3.0	3.0	3.0	3.0	3.0
Dehumidification (pints/hr)	1.3	1.3	1.9	2.1	2.8	2.9	3.6	3.7
ELECTRICAL DATA:								
Voltage (1 PHASE, 60 Hz)	230/208	265	230/208	265	230/208	265	230/208	265
Current (AMPS)	3.2/3.3	2.8	3.6/3.9	3.3	5.4/5.7	5.2	6.7/7.3	6.3
Reverse heat. AMPS	2.7/2.8	2.6	4.3/4.5	3.0	4.4/4.7	4.4	6.2/6.5	5.6
AMPS L.R.	13.0	15.0	19.8	16.8	27.00	23.0	32.0	27.0
AMPS F.L.	2.9	2.6	3.7	3.2	5.0	4.5	6.3	5.6
AIRFLOW DATA:								
Indoor CFM, HIGH	210	240	220	210	320	310	315	330
Indoor CFM, LOW	200	200	200	200	260	260	280	280
Vent CFM	60	60	60	60	70	70	70	70
PHYSICAL DATA:								
Dimensions	16x42x13.5	16x42x13.5	16x42x13.5	16x42x13.5	16x42x13.5	16x42x13.5	16x42x13.5	16x42x13.5
Net weight (lbs.)	105	105	112	112	120	120	125	125
Shipping weight (lbs.)	125	125	132	132	140	140	145	145
R-410A charge (oz.)	37	37	37	33	41	40	39	42

PDE/PDH Series - Electric Heating Data

	PDE/PDH07K		PDE/PDH07R		PDE09K0	PDE/PDH09K			PDE/PDH09R		
Heater watts	2500/2050	3400/2780	2500	3400	0 Kw	2500/2050	3400/2780	5000/4090	2500	3400	5000
Voltage	230/208		265			230/208			265		
Heating BTUh	8500/7000	11600/9500	8500	11600	0	8500/7000	11600/9500	17000/13900	8500	11600	17000
Heating current(AMPS)	11.4/10.4	15.3/13.9	9.8	13.2	0	11.4/10.4	15.3/13.9	22.3/20.3	9.8	13.2	19.5
Minimum circuit ampacity	14.1	19.0	12.2	16.4	5.2	14.1	19	27.8	12.2	16.4	24.2
Branch circuit fuse (AMPS)	15	20	15	20	15	15	20	30	15	20	30

	PDE12K0	PDE/PDH12K			PDE/PDH12R			PDE15K0	PDE/PDH15K			PDE/PDH15R		
Heater watts	0 Kw	2500/2050	3400/2780	5000/4090	2500	3400	5000	0 Kw	2500/2050	3400/2780	5000/4090	2500	3400	5000
Voltage		230/208			265				230/208			265		
Heating BTUh	0	8500/7000	11600/9500	17000/13900	8500	11600	17000	0	8500/7000	11600/9500	17000/13900	8500	11600	17000
Heating current(AMPS)	0	11.4/10.4	15.3/13.9	22.3/20.3	9.8	13.2	19.5	0	11.4/10.4	15.3/13.9	22.3/20.3	9.8	13.2	19.5
Minimum circuit ampacity	7.9	14.1	19	27.8	12.2	16.4	24.2	8.5	14.1	19	27.8	12.2	16.4	24.2
Branch circuit fuse (AMPS)	15	15	20	30	15	20	30	15	15	20	30	15	20	30

Five-year warranty limited to installations in the United States, Puerto Rico, Mexico and Canada only.
See warranty documentation for full details.



Friedrich Air Conditioning Co. | P.O. Box 1540 | San Antonio, TX 78295-1540 | 800.541.6645 | fax 210.357.4480
www.friedrich.com