

Commercial & Residential Applications

When should you
install a solid side
sleeve?

SOLID SIDE wall sleeve
allows for installation in
thick exterior walls where
the installation of room air
units with side vents would
effect performance and may
even void the warranty.

ROOM AIR CONDITIONER
Blocked side vents restrict air flow

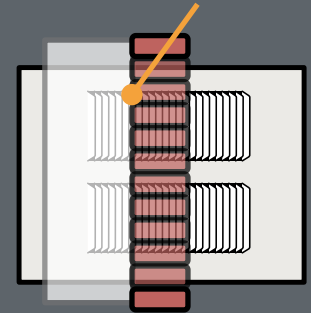

FRIEDRICH THRU-THE-WALL
*Solid-side sleeve (no side vents) can
be installed flush with exterior wall.*

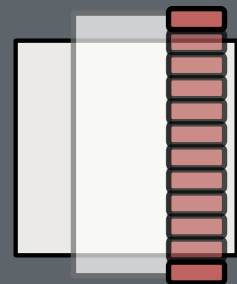

Specifications ENERGY STAR® models

Model	Cooling Capacity BTU/h	Heating Capacity BTU/h	Volts Rated	Cooling Amps	Cooling Watts	Heating Amps	Heating Watts	Energy Efficiency Ratio EER	Moisture Removal Pints/Hr.	Room Side Air Circulation	Sleeve	Weight Lbs. Ship/Net
WALLMASTER												
★ WS08B10A	8000	—	115	6.8	762	—	—	10.5	1.3	245	WSC	97/93
★ WS10B10A	10000	—	115	8.7	954	—	—	10.5	2.4	245	WSC	107/103
★ WS14B10A	13500	—	115	12.0	1415	—	—	9.5	3.3	295	WSC	116/112
★ WS10B30A	10000/10000	—	230/208	4.6/5.0	1005/996	—	—	10.0/10.0	2.1	260	WSC	105/101
WS13B30B	12500/12000	—	230/208	6.3/6.7	1404/1379	—	—	8.9/8.7	3.3	280	WSC	113/109
WS16B30A	15800/15000	—	230/208	7.8/8.5	1756/1705	—	—	9.0/8.8	4.2	290	WSC	123/119
WE10B33C	10000/10000	11000/9100	230/208	4.6/5.0	1005/996	16.0/14.7	3550/2950	10.0/10.0	2.1	260	WSC	107/103
WE13B33C	12500/12000	11000/9100	230/208	6.3/6.7	1404/1379	16.0/14.7	3550/2950	8.9/8.7	3.3	280	WSC	115/111
WE16B33C	15800/15000	11000/9100	230/208	7.8/8.5	1756/1705	16.0/14.7	3550/2950	9.0/8.8	4.2	290	WSC	125/121
★ WY10B33C	10100/9800	8100/7800	230/208	4.6/4.8	1013/976	3.9/4.0	857/821	10.0/10.0	2.5	230	WSC	111/107
WY13B33C	12500/12100	10400/10000	230/208	6.4/6.8	1389/1352	5.4/5.7	1182/1136	9.0/9.0	3.2	280	WSC	120/116
UNI-FIT												
★ US08B10A	8000	—	115	7.5	830	—	—	9.6	2.2	260	USC	77/73
★ US10B10B	9800	—	115	9.6	1040	—	—	9.4	3.2	270	USC	82/78
★ US10B30A	10000/9800	—	230/208	4.7/5.2	1060/1040	—	—	9.4	3.2	285	USC	82/78
★ US12B10B	11500	—	115	11.2	1220	—	—	9.4	3.8	290	USC	84/80
★ US12B30C	11500/11200	—	230/208	5.6/6.0	1250/1190	—	—	9.4	3.8	290	USC	84/80
US14B30A	13000/12600	—	230/208	7.0/7.5	1530/1480	—	—	8.5	4.0	300	USC	88/84
UE08A13B	8000	3850	115	7.5	830	10.7	1230	9.6	2.2	260	USC	77/73
UE10A33B	10000/9800	11200/9200	230/208	4.7/5.2	1060/1040	15.3/14.0	3500/2900	9.4	3.2	285	USC	82/78
UE12A33C	11500/11200	11200/9200	230/208	5.6/6.0	1220/1190	15.3/14.0	3500/2900	9.4	3.8	290	USC	84/80

WallMaster Heat Pump heating information (shown in red) indicates heat pump heating performance. WallMaster Electric Heat heating information (shown in red) indicates electric heat strip performance. For WallMaster Heat Pump electric heating performance refer to corresponding WallMaster Electric Heat model.

WALLMASTER HEAT PUMP

HEATING PERFORMANCE

Change-over from heat pump operation to resistance operation on models indicated is automatic at a preset outside ambient temperature of approximately 35°F.



Calculate the heat loss of the space to be heated. As long as the heat loss does not exceed the resistance heating capacity rating of the unit, the heating performance will be satisfactory.

Note: all models will produce condensate. If condensate disposal is desired, an optional drain kit is available.

DEFROST CONTROL: Initiated at 20°F (outdoor coil temperature) and terminated at 43°F (outdoor coil temperature). During defrost, the compressor stops and the electric heat starts, then operates with the fan to maintain indoor comfort. Below 43°F, the unit remains in electric heat mode. During electric heat mode, the unit will achieve the following ratings: 11000/9100 BTU/h, 16.0/14.7 amps, and 3550/2950 watts.

DEFROST DRAIN: Drain automatically opens at approximately 50°F to prevent condensate from freezing inside drain pan.

Plug Face/ Circuit Rating

WallMaster Model Number	Uni-Fit Model Number	Circuit Rating Breaker or T-D Fuse	Plug Face (NEMA#)	Power Cord Length (ft.)	Wall Outlet Appearance
WS08B10A, WS10B10A, WS14B10A	US08B10A, UE08A13B US10B10B, US12B10B	125V - 15A	5 - 15P	6	
WS10B30A, WS13B30B, WS16B30A	US10B30A, US12B30C, US14B30A	250V - 15A	6 - 15P	4	
WE10B33C, WE13B33C, WE16B33C, WY10B33C, WY13B33C	UE10A33B, UE12A33C	250V - 20A	6 - 20P	4	

Power cords are located on front left of WallMaster models and on front right of Uni-Fit models.



As an ENERGY STAR® partner, Friedrich Air Conditioning Co. has determined that the selected ENERGY STAR® models (★) meet the ENERGY STAR® guidelines for energy efficiency.



Thru-the-wall AIR CONDITIONERS

P R E L I M I N A R Y



COOL ONLY | HEAT PUMPS | ELECTRIC HEAT

2009

Friedrich

Friedrich thru-the-wall air conditioners are ideal for new construction, retrofits and remodels



WallMaster®

8,000 to 15,800 BTU/h COOLING | 8,100 to 11,000 BTU/h HEATING
EERs up to 10.5

cool only / heat pumps / cool w/electric heat

- High efficiency operation saves on energy costs
- Residential/commercial applications
- Mounts flush with the exterior wall for a neat appearance
- A high efficiency replacement for 27" sleeves including Fedders A and B*. Sleeve measures 27" W x 16 3/4" H
- Ideal for thicker wall installations, where side fins don't fit
- Easy-to-reach, top mount controls
- Three-speed fan
- Efficient rotary compressor
- Easy-to-clean filter
- Auto restart

The Most Energy Efficient Solid-side Air Conditioner

Chassis installs into existing 27" sleeves



DIGITAL CONTROLS FEATURE

- Fully functional remote control
- 24 hour programmable timer
- Money Saver® setting saves energy by cycling the fan with the compressor
- Smart Fan auto-adjusts fan speed to maintain desired temperature
- Auto-memory backup saves setting should power be interrupted

REMOTE CONTROL	24-HOUR TIMER	MONEY SAVER FEATURE	SMART FAN	ANTIMICROBIAL FILTER
✓	✓	✓	✓	✓



Sleeve Dimensions	Friedrich WSC Sleeve	Fedders A Sleeve	Fedders B Sleeve*
Height (inches)	16 3/4	16 3/4	16 3/4
Width (inches)	27	27	27
Depth (inches)	16 3/4	16 3/4	19 3/4

Units are shown installed in WSC sleeve (sold and shipped separately)
 *Installation in Fedders B sleeve requires a baffle kit. See BAK accessory under accessories.

THRU-THE-WALL units mount flush with exterior walls for a sleek appearance, as well as unobstructed window views. (Wallmaster WSC sleeve shown with architectural grille. Uni-fit grille has different appearance.)



Uni-fit®

8,000 to 13,000 BTU/h COOLING | 3,850 to 11,200 BTU/h HEATING

EERs up to 9.6

cool only, cool w/electric heat

- Rotary compressors provide quiet, dependable performance
- Six-way air flow control
- Stale air exhaust
- Auto restart
- Washable/reusable filter
- Seacoast protection

HEAT/COOL MODELS feature mechanical controls, two cooling speeds, two heating speeds, plus one fan-only setting.

COOLING MODELS feature electronic controls with remote control, Money Saver® setting that saves energy by cycling the fan with the compressor and three cooling/three fan-only speeds.

DIGITAL CONTROLS FEATURE (cool only models)

- 12 hour programmable timer
- Money Saver® setting saves energy by cycling the fan with the compressor



Universal Fit for Easy Replacement
Chassis installs into existing 26" sleeves



REMOTE CONTROL	12-HOUR TIMER	MONEY SAVER FEATURE
✓	✓	✓

Sleeve Dimensions	Friedrich USC Sleeve	Amana	Carrier (51S Series)	Fedders/Emerson/Friedrich WSC	Emerson/Fedders	GE/Hotpoint	Whirlpool	White-Westinghouse/Frigidaire/Carrier (52F Series)
Height (inches)	15 17/32	15 5/8	16 7/8	16 3/4	15 3/4	15 5/8	16 1/2	15 1/4
Width (inches)	25 7/8	26	25 3/4	27	26 3/4	26	25 7/8	25 1/2
Depth (inches)	16 23/32	16 7/8	18 5/8	16 3/4 or 19 3/4	15	16 7/8	17 1/8 or 23	16, 17 1/2 or 22

5 ENERGYSTAR® models



Units are shown without USC sleeve (USC sleeves sold and shipped separately)

WallMaster | 27" Sleeve Exterior Grilles



WSC Sleeve
Standard Grille - Ships
with sleeve



WSC Sleeve
Optional Architectural Grille- AG

IMPORTANT:

Operating the air conditioner with incorrect rear grille or without Baffle Adapter Kit (on 19 3/4" deep sleeve) will recirculate discharge air and cause compressor overload to trip.

CORRECT Vertical Louvers

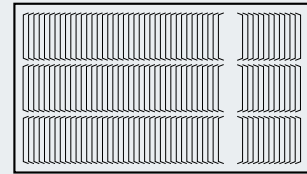

INCORRECT Horizontal Louvers

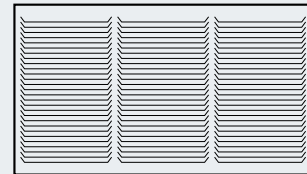

Installation Accessories (27" sleeve models only)

DK / Drain Kit

Installed at the back of the unit and allows for attachment to permanent condensate disposal system, if disposal is necessary or desired.

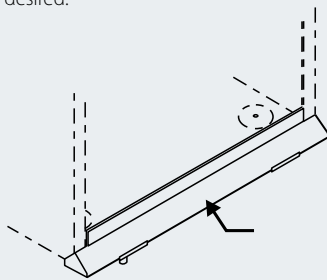

SB / Sub Base

Used as a base for the unit when it is desired to place the cord and receptacle within the installation, or simply as a base for the unit when mounted low in the wall.

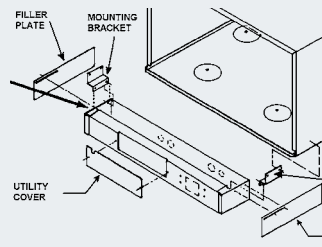

IDK / Internal Drain Kit

New construction applications where a condensate drain system has been built into the wall interior.

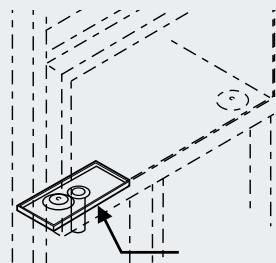

BAK / Baffle Adapter Kit

Necessary when installing in a sleeve deeper than 16 3/4" deep, such as Fedders B sleeve (19 3/4" deep).

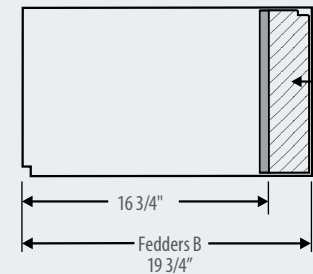

Uni-Fit | 26" Sleeve Exterior Grilles



USC Sleeve
Standard Grille



Sleeve shown with
Replacement Grille

STANDARD GRILLE - Ships with USC sleeve

Expanded aluminum grille designed for use with USC sleeve.

REPLACEMENT GRILLE - Ships with US/UE chassis

High-tech plastic for use on existing sleeves without any grille.

IMPORTANT:

When installing into an existing sleeve, consult Installation Section of your Installation/Operation Manual to determine whether or not the grille needs to be replaced and/or a baffle adapter should be used.

WallMaster | Uni-Fit | Sleeve/Chassis Dimensions

Model	Height	Width	Depth	Depth with Front	Minimum Extension Into Room	Minimum Extension Outside	Thru-the-wall Finished Hole		
							Height	Width	Max. Depth
WALLMASTER									
WSC Sleeve	16 3/4"	27"	16 3/4"	23"	7 1/2"	9/16"	17 1/4"	27 1/4"	15 5/16"
Chassis	15 3/4"	26 1/2"	21"	22"	-	-	-	-	-
UNI-FIT									
USC Sleeve	15 1/2"	25 7/8"	16 3/4"	20 1/2"	-	1/2"	15 3/4"	26 1/8"	16 1/4"
US Chassis	14 3/8"	24"		20 1/8"	3 3/4"	-	-	-	-
UE Chassis	14 3/8"	24 5/8"		19 5/8"	3 1/2"	-	-	-	-

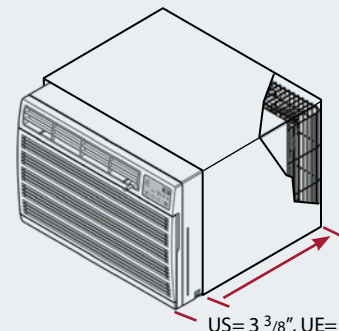

IMPORTANT:

US chassis w/front fully installed into USC sleeve extends into room 3 3/8". UE chassis w/front fully installed into USC sleeve extends into room 2 7/8".

IMPORTANT: Sleeves are sold and shipped separately to accommodate new construction and replacement requirements