

Owner's Manual

Advantium® 120V Speedcook Oven

For Models:

ZSC1201

ZSC1202

Write the model and serial numbers here:

Model # _____

Serial # _____

Find these numbers on a label inside
the oven.

49-40591
MFL38211606

11-08 JR

monogram.com



IMPORTANT SAFETY INSTRUCTIONS

Advantium Oven

PRECAUTIONS TO AVOID POSSIBLE EXPOSURE TO EXCESSIVE MICROWAVE ENERGY

- (a) **Do Not Attempt** to operate this oven with the door open since open-door operation can result in harmful exposure to microwave energy. It is important not to defeat or tamper with the safety interlocks.
- (b) **Do Not Place** any object between the oven front face and the door or allow soil or cleaner residue to accumulate on sealing surfaces.
- (c) **Do Not Operate** the oven if it is damaged. It is particularly important that the oven door close properly and that there is no damage to the:
- (1) door (bent),
 - (2) hinges and latches (broken or loosened),
 - (3) door seals and sealing surfaces.
- (d) **The Oven Should Not** be adjusted or repaired by anyone except properly qualified service personnel.

Contents

Advantium

Advantium Quick Start	15
Cooking controls	18
Oven features	17
Safety	2-13
What is Advantium?	14

Speedcooking

Convection Baking, Broiling and Toasting	26
Cooking tips	20
Favorite recipes	23, 24
Power level	21
Proofing	27
Repeat last	20
Resume feature	20
Speedcook cookware	22
Speedcook menu guide	16
Speedcook-safe cookware	5
Things that are normal	25
Using a preset speedcook menu	19
Warming	27

Microwaving

Cooking by time	29
Cooking tips	29
Defrost by food type	30
Defrost by time	30
Defrosting tips	31
Express	15, 29
Favorite recipes	29
Microwave power level(s)	29
Microwave-safe cookware	6

Precautions to avoid possible exposure to excessive microwave energy	2
Sensor cooking	32, 33
Things that are normal	33
Using preset microwave selections	28

Other Features

Automatic fan	36
Beeper volume	34
Child lockout	36
Clock	15, 34
Delay Start	34
Display ON/OFF	34
Help	35
Reminder	34
Review	34
Scroll speed	34
Timer	36

Care and Cleaning

Cleaning the inside	37
Cleaning the outside	38
Cooking trays and baking sheet	38
Removable turntable	37

Troubleshooting

Problem Solver	39, 40
----------------------	--------

Customer Service

Service phone numbers	43
Warranty	Back Cover

IMPORTANT SAFETY INSTRUCTIONS

Advantium Oven

▲ WARNING! *To reduce the risk of burns, electric shock, fire, injury to persons, or exposure to excessive microwave energy:*

SAFETY PRECAUTIONS

- **Read all instructions before using this appliance. When using electrical appliances, basic safety precautions should be followed, including the following:**
- Read and follow the specific precautions in the *PRECAUTIONS TO AVOID POSSIBLE EXPOSURE TO EXCESSIVE MICROWAVE ENERGY* section on page 2.
- Be sure your appliance is properly installed and grounded by a qualified technician in accordance with the provided installation instructions.
- Install or locate this appliance only in accordance with the provided installation instructions.
- Some products such as whole eggs and sealed containers—for example, closed jars—are able to explode and should not be heated in this oven. Such use of the oven could result in injury.
- Do not mount this appliance over a sink.
- Do not store anything directly on top of the microwave oven surface when the microwave oven is in operation.
- This oven is not approved or tested for marine use.
- This oven is UL listed for standard wall installation.
- Do not operate this appliance if it has been damaged or dropped.
- As with any appliance, close supervision is necessary when used by children.
- Use this appliance only for its intended use as described in this manual.
- Do not use corrosive chemicals or vapors in this appliance.
- This oven is specifically designed to heat, dry or cook food, and is not intended for laboratory or industrial use.
- This appliance must only be serviced by qualified service personnel. Contact nearest authorized service facility for examination, repair or adjustment.
- Do not cover or block any openings on the appliance.
- Do not store this appliance outdoors. Do not use this product near water—for example, in a wet basement, near a swimming pool, near a sink or in similar locations.
- It is important to keep the area clean where the door seals against the microwave. Use only mild, non-abrasive detergents applied with a clean sponge or soft cloth. Rinse well.
- To reduce the risk of fire in the oven cavity:
 - Do not overcook food. Carefully attend appliance when paper, plastic or other combustible materials are placed inside the oven while microwave cooking.
 - Remove wire twist-ties and metal handles from paper or plastic containers before placing them in the oven.
 - Do not use the oven for storage purposes. Do not leave paper products, cooking utensils or food in the oven when not in use.
 - If materials inside the oven ignite, keep the oven door closed, turn the oven off and shut off power at the fuse or circuit breaker panel. If the door is opened, the fire may spread.
 - Do not use the Sensor Features twice in succession on the same food portion. If food is undercooked after the first countdown, use COOK BY TIME for additional cooking time.
- If installing the Advantium 120V Oven below 36", you must use the plastic bottom trim due to burn risk to children. The plastic trim acts as insulation and will help prevent burns to children from hot surfaces.
- If installing the Advantium 120V Oven below 36", do not remove the door's plastic bottom trim due to burn risk to children. The plastic trim acts as insulation and will help prevent burns to children from hot surfaces.

SAVE THESE INSTRUCTIONS

IMPORTANT SAFETY INSTRUCTIONS

Advantium Oven

▲ **WARNING!**

SAFETY PRECAUTIONS

- Do not operate the oven without the turntable in place. The turntable must be unrestricted so it can turn.
- During and after use, do not touch, or let clothing or other flammable materials contact any interior area of the oven; allow sufficient time for cooling first.
- Keep the oven free from grease buildup.
- Cook meat and poultry thoroughly—meat to at least an INTERNAL temperature of 160°F, and poultry to at least an INTERNAL temperature of 180°F. Cooking to these temperatures usually protects against foodborne illness.
- Potentially hot surfaces include the oven door, floor, walls, oven rack and turntable.

ARCING

Arcing can occur during both speedcooking and microwave cooking. If you see arcing, press the CLEAR/OFF pad and correct the problem.

Arcing is the microwave term for sparks in the oven. Arcing is caused by:

- Metal or foil touching the side of the oven.
- Foil not molded to food (upturned edges act like antennas).
- Use foil only as recommended in this manual.
- Metal cookware used during either speedcook or microwave cooking (except for the pans provided with the oven).
- Metal, such as twist-ties, poultry pins, or gold-rimmed dishes, in the oven.
- Recycled paper towels containing small metal pieces being used in the oven.

FOODS

- When microwaving, place all foods and containers on the clear glass tray.
- Do not pop popcorn in your oven unless in a special microwave popcorn accessory or unless you use popcorn labeled for use in microwave ovens.
- Do not boil eggs in this oven. Pressure will build up inside egg yolk and will cause it to burst, possibly resulting in injury.
- Do not operate the oven without food inside. This may cause damage to the oven. It increases the heat around the magnetron and can shorten the life of the oven.
- Foods with unbroken outer “skin” such as potatoes, hot dogs, sausages, tomatoes, apples, chicken livers and other giblets, and egg yolks should be pierced to allow steam to escape during cooking.
- **SUPERHEATED WATER**
Liquids, such as water, coffee or tea, are able to be overheated beyond the boiling point without appearing to be boiling. Visible bubbling or boiling when the container is removed from the microwave oven is not always present. THIS COULD RESULT IN VERY HOT LIQUIDS SUDDENLY BOILING OVER WHEN THE CONTAINER IS DISTURBED OR A SPOON OR OTHER UTENSIL IS INSERTED INTO THE LIQUID.

To reduce the risk of injury to persons:

- Do not overheat the liquid.
- Stir the liquid both before and halfway through heating it.
- Do not use straight-sided containers with narrow necks.
- After heating, allow the container to stand in the microwave oven for a short time before removing the container.
- Use extreme care when inserting a spoon or other utensil into the container.

IMPORTANT SAFETY INSTRUCTIONS

Advantium Oven

▲ WARNING!

Speedcook oven-safe cookware

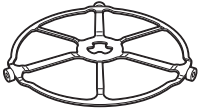

The **turntable** must always be in place when using the oven.

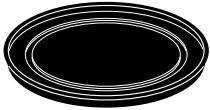

Put food directly on the **nonstick metal tray** to speedcook.

- The oven and door will get very hot when speedcooking.
- Cookware will become hot because of heat transferred from the heated food. Oven mitts will be needed to handle the cookware.
- Do not use coverings, containers or cooking/roasting bags made of foil, plastic, wax or paper when speedcooking.
- Do not cover the turntable, wire oven rack, trays or any part of the oven with metal foil. This will cause arcing in the oven.
- Use the nonstick metal tray in the same way you would use a shallow baking pan or baking tray.
- Place food directly on the trays when cooking unless prompted by the oven to do otherwise.
- Any oven-safe dish can be used in your oven. Recipes in the Advantium Cookbook were tested in Pyrex® glass cookware and Corningware® ceramic casseroles. Cook times and results may vary when using other types of oven-safe dishes. Place them directly on the trays.
- Do not use the oven to dry newspapers.
- Use of the clear glass tray when speedcooking will result in inferior cooking performance.

Oven-safe cookware for Baking, Broiling, Warming, Proofing & Toasting

- The oven and door will get very hot when baking, broiling, warming, proofing or toasting.
- Cookware will become hot. Oven mitts will be needed to handle the cookware.
- Do not use coverings, containers or cooking/roasting bags made of foil, plastic, wax or paper when speedcooking.
- Do not cover the turntable, wire oven rack, trays or any part of the oven with metal foil. This will cause arcing in the oven.
- Use the nonstick metal tray in the same way you would use a shallow baking pan or baking tray.
- Use the aluminum baking sheet on the wire oven rack, and place them on the nonstick metal tray when baking on two levels, broiling or toasting foods.
- Place food directly on the trays when cooking unless prompted by the oven to do otherwise.
- Any oven-safe dish can be used in your oven. Recipes in the Advantium Cookbook were tested in Pyrex® glass cookware and Corningware® ceramic casseroles. Cook times and results may vary when using other types of oven-safe dishes. Place them directly on the trays.
- Do not use the oven to dry newspapers.
- Use of the clear glass tray when baking, broiling, warming, proofing or toasting will result in inferior cooking performance.

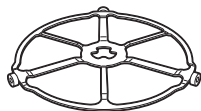

The **turntable** must always be in place when using the oven.

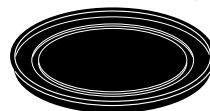

Put food directly on the **nonstick metal tray** to bake on one level.

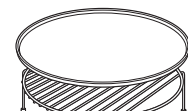

Put food directly on the aluminum baking sheet on the wire oven rack, and place them on the nonstick metal tray, when baking on two levels, broiling or toasting foods.

SAVE THESE INSTRUCTIONS

IMPORTANT SAFETY INSTRUCTIONS

Advantium Oven

▲ WARNING!

Microwave-safe cookware

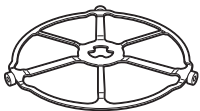

The **turntable** must always be in place when using the oven.

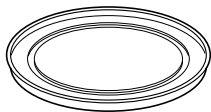

The **clear glass tray** should always be in place when **microwaving**.

Make sure to use suitable cookware during microwave cooking. Most glass casseroles, cooking dishes, measuring cups, custard cups, pottery or china dinnerware which does not have metallic trim or glaze with a metallic sheen can be used. Some cookware is labeled "suitable for microwaving."

- Place food or microwavable container directly on the clear glass tray to cook your food.
- Use of the nonstick metal tray during microwave cooking will result in inferior cooking performance.
- If you are not sure if a dish is microwave-safe, use this test: Place in the oven both the dish you are testing and a glass measuring cup filled with 1 cup of water—set the measuring cup either in or next to the dish. Microwave 30–45 seconds at high. If the dish heats, it should not be used for microwaving.



How to test for a microwave-safe dish.

- If the dish remains cool and only the water in the cup heats, then the dish is microwave-safe.
- Cookware may become hot because of heat transferred from the heated food. Oven mitts may be needed to handle the cookware.
- Do not use recycled paper products. Recycled paper towels, napkins and waxed paper can contain metal flecks which may cause arcing or ignite. Paper products containing nylon or nylon filaments should be avoided, as they may also ignite.
- Use foil only as directed in this manual. When using foil in the oven, keep the foil at least 1" away from the sides of the oven.
- Do not use the oven to dry newspapers.
- If you use a meat thermometer while cooking, make sure it is safe for use in microwave ovens.
- Some styrofoam trays (like those that meat is packaged on) have a thin strip of metal embedded in the bottom. When microwaved, the metal can burn the floor of the oven or ignite a paper towel.
- Paper towels, waxed paper and plastic wrap can be used to cover dishes in order to retain moisture and prevent spattering. Be sure to vent plastic wrap so steam can escape.
- Not all plastic wrap is suitable for use in microwave ovens. Check the package for proper use.
- "Boilable" cooking pouches and tightly closed plastic bags should be slit, pierced or vented as directed by package. If they are not, plastic could burst during or immediately after cooking, possibly resulting in injury. Also, plastic storage containers should be at least partially uncovered because they form a tight seal. When cooking with containers tightly covered with plastic wrap, remove covering carefully and direct steam away from hands and face.
- Plastic cookware—Plastic cookware designed for microwave cooking is very useful, but should be used carefully. Even microwave-safe plastic may not be as tolerant of overcooking conditions as are glass or ceramic materials and may soften or char if subjected to short periods of overcooking. In longer exposures to overcooking, the food and cookware could ignite.

Follow these guidelines:

1. Use microwave-safe plastics only and use them in strict compliance with the cookware manufacturer's recommendations.
2. Do not microwave empty containers.
3. Do not permit children to use plastic cookware without complete supervision.

SAVE THESE INSTRUCTIONS

IMPORTANT SAFETY INSTRUCTIONS

Advantium Oven

▲ WARNING!

SAFETY PRECAUTIONS

- Don't defrost frozen beverages in narrow-necked bottles (especially carbonated beverages). Even if the container is open, pressure can build up. This can cause the container to burst, possibly resulting in injury.
- Foods cooked in liquids (such as pasta) may tend to boil more rapidly than foods containing less moisture. Should this occur, refer to the *Care and Cleaning of the oven* section for instructions on how to clean the inside of the oven.
- Hot foods and steam can cause burns. Be careful when opening any containers of hot food, including popcorn bags, cooking pouches and boxes. To prevent possible injury, direct steam away from hands and face.
- Do not overcook potatoes. They could dehydrate and catch fire, causing damage to your oven.
- Avoid heating baby food in glass jars, even with the lid off. Make sure all infant food is thoroughly cooked. Stir food to distribute the heat evenly. Be careful to prevent scalding when warming formula. The container may feel cooler than the formula really is. Always test the formula before feeding the baby.
- Do not attempt to deep fry in the oven.

Notice— Pacemakers

- Most pacemakers are shielded from interference from electronic products, including microwaves. However, patients with pacemakers may wish to consult their physicians if they have concerns.

SAVE THESE INSTRUCTIONS

PRÉCAUTIONS POUR ÉVITER UNE ÉVENTUELLE EXPOSITION EXCESSIVE AUX MICRO-ONDES

- (a) N'essayez pas** de faire fonctionner le four à micro-ondes lorsque la porte est ouverte, puisque cela pourrait entraîner une exposition nocive aux micro-ondes. Il est important de ne jamais essayer de forcer ou modifier le système de verrouillage de sécurité.
- (b) Ne placez pas** d'objets entre la porte et la surface avant du four. Ne laissez pas de saleté ou de résidus de produits nettoyants s'accumuler sur les surfaces d'étanchéité.
- (c) Ne faites pas fonctionner** le four s'il est endommagé. Il est très important que la porte ferme bien et que les pièces suivantes ne soient pas endommagées :
- (1) La porte (tordue),
 - (2) Les charnières et loquets (cassés ou desserrés),
 - (3) Les joints et surfaces d'étanchéité.
- (d) Seul un technicien qualifié** doit réparer ou régler votre four à micro-ondes.

CONSERVEZ CES DIRECTIVES

MESURES DE SÉCURITÉ IMPORTANTES

Four Advantium

▲ MISE EN GARDE!

MESURES DE SÉCURITÉ

Pour réduire le risque de brûlures, de choc électrique, d'incendie, de blessures à autrui ou d'exposition excessive aux micro-ondes :

- **Veillez lire les mesures de sécurité avant d'utiliser le four. Lors de l'utilisation d'appareils électriques, il faut observer des mesures de sécurité élémentaires, et en particulier :**
- Veillez lire et observer les « Précautions pour éviter une éventuelle exposition excessive aux micro-ondes » à la page 8.
- Assurez-vous que l'appareil soit installé et mis à la terre correctement par un technicien qualifié conformément aux directives d'installation fournies.
- Installez et placez cet appareil seulement selon les directives d'installation fournies.
- Certains aliments comme les oeufs dans leur coquille et les récipients scellés—par exemple, des pots en verre fermés—peuvent éclater s'ils sont chauffés dans le four à micro-ondes et risquent de vous blesser.
- N'installez pas cet appareil au-dessus d'un évier.
- Ne mettez rien directement sur la surface de votre four à micro-ondes pendant qu'il fonctionne.
- Ce four à micro-ondes n'a pas été approuvé ou mis à l'essai pour être utilisé en mer.
- Ce four est homologué UL pour une installation murale standard.
- N'utilisez pas cet appareil s'il a été endommagé ou s'il est tombé.
- Comme avec tout appareil, il est important de surveiller étroitement lorsque le four est utilisé par des enfants.
- N'utilisez cet appareil que pour l'usage auquel il est destiné, tel que décrit dans le présent manuel.
- N'utilisez pas de substances chimiques ou corrosives dans cet appareil.
- Ce four à micro-ondes a été conçu spécifiquement pour chauffer, sécher ou cuire des aliments et non pour être utilisé en laboratoire ou à des fins industrielles.
- Seul un technicien qualifié doit réparer cet appareil. Communiquez avec le bureau de service après-vente le plus près si votre appareil doit être vérifié, réparé ou réglé.
- Ne couvrez pas ou ne bloquez pas les ouvertures de l'appareil.
- Ne rangez pas cet appareil à l'extérieur. N'utilisez pas ce four à proximité de l'eau, par exemple, dans un sous-sol mouillé, près d'une piscine d'un évier ou dans des emplacements semblables.
- Il est important que la surface de contact entre la porte et le four à micro-ondes soit toujours bien propre. Utilisez un détergent doux, non-abrasif sur une éponge propre ou un linge souple. Rincez bien.
- Pour réduire les risques d'incendie à l'intérieur du four :
 - Ne faites pas trop cuire les aliments. Surveillez la cuisson de près quand vous utilisez du papier, du plastique ou d'autres matières inflammables dans votre four pendant la cuisson.
 - Enlevez les attaches métalliques et les poignées en métal des contenants de papier ou de plastique avant de les mettre dans le four.
 - Ne rangez rien dans le four. Ne laissez pas de produits en papier, ustensiles de cuisson ou aliments dans le four lorsqu'il n'est pas utilisé.
 - Si un feu éclate dans votre four, laissez la porte fermée, éteignez le four et débranchez le cordon d'alimentation ou coupez le courant en enlevant le fusible ou en déclenchant le disjoncteur. Si vous ouvrez la porte, les flammes risquent de se propager.
 - N'utilisez pas les fonctions de capteur deux fois de suite sur la même section de nourriture. Si la nourriture n'est pas assez cuite après le premier passage, utilisez COOK BY TIME (TEMPS DE CUISSON) pour ajouter du temps de cuisson.
- Ne faites pas fonctionner le four sans plateau tournant. Le plateau doit pouvoir tourner sans restriction.
- Durant et après l'usage, ne touchez pas ou ne laissez pas de vêtements ou autres matériaux inflammables entrer en contact avec l'intérieur du four. Prévoyez suffisamment de temps pour le refroidissement.
- Si vous installez le four Advantium 120V sous 36 po (91 cm), vous devez utiliser la garniture inférieure en plastique étant donné le risque de brûlure couru par les enfants. La garniture en plastique agit en tant qu'isolation et contribuera à protéger les enfants contre le risque de brûlure au contact des surfaces chaudes.
- Si vous installez le four Advantium 120V sous 36 po (91 cm), n'enlevez pas la garniture inférieure en plastique de la porte étant donné le risque de brûlure couru par les enfants. La garniture en plastique agit en tant qu'isolation et contribuera à protéger les enfants contre le risque de brûlure au contact des surfaces chaudes.

CONSERVEZ CES DIRECTIVES

MESURES DE SÉCURITÉ IMPORTANTES

Four Advantium

▲ MISE EN GARDE!

MESURES DE SÉCURITÉ

- Gardez le four libre de toute accumulation de graisse.
- Faites bien cuire la viande et la volaille—la viande doit avoir une température INTERNE de 160° F (71° C), et la volaille une température INTERNE d'au moins 180° F (83° C). Une préparation à ces niveaux de température protège normalement des maladies alimentaires.
- Les surfaces chaudes peuvent inclure la porte du four, le plancher, les parois, le plateau de cuisson et le plateau tournant.

ARC D'ÉTINCELLES

Un arc peut apparaître durant la cuisson rapide et la cuisson à micro-ondes. Si vous voyez un arc, appuyez sur la touche annulation/arrêt (CLEAR/OFF) et corrigez le problème.

La formation d'un arc est la façon qu'ont les micro-ondes de produire des étincelles dans le four. Ceci est imputable aux causes suivantes :

- Un article de métal ou du papier d'aluminium est en contact avec les parois du four.
- Le papier d'aluminium n'épouse pas bien la forme de l'aliment (les bords relevés agissent comme des antennes).
- Utilisez de papier d'aluminium sauf comme il est décrit dans le présent manuel.
- Les ustensiles de cuisson de métal utilisés durant la cuisson rapide ou la cuisson à micro-ondes (sauf les casseroles fournies avec le four).
- Des articles en métal, comme des attaches, les broches utilisées pour la volaille ou les garnitures dorées des assiettes se trouvent dans le four.
- Des essuie-tout en papier recyclé contenant de petites particules de métal sont employés dans le four.

ALIMENTS

- Pour la cuisson à micro-ondes, placez tous les aliments et contenants sur le plateau de verre transparent.
- Ne préparez pas de maïs éclaté dans votre four à micro-ondes, à moins d'utiliser un grille-maïs spécialement conçu à cette fin ou du maïs éclaté pour la cuisson aux micro-ondes.
- Il n'est pas recommandé de faire bouillir des oeufs dans le four. La pression qui se crée dans le jaune fera éclater l'oeuf et pourrait causer des blessures.
- Le fait de laisser fonctionner le four à micro-ondes sans placer d'aliment à l'intérieur peut endommager le four. Cela augmente la température autour du magnétron et peut affecter la durée de vie de votre four.
- Percez la « peau » qui recouvre certains aliments, comme les pommes de terre, les saucisses fumées, les saucissons, les tomates, les pommes, le foie de poulet et autres abats, les jaunes d'oeuf, pour permettre à la vapeur de s'échapper pendant la cuisson.

■ EAU SURCHAUFFÉE

Les liquides, tels que l'eau, le café ou le thé peuvent être surchauffés au-delà du point d'ébullition sans avoir l'air de bouillir. Une ébullition ou formation de bulles n'est pas toujours visible lorsque le récipient est sorti du four à micro-ondes. CECI PEUT ENTRAÎNER DES DÉBORDEMENTS SOUDAINS DE LIQUIDES BRÛLANTS LORSQUE LE RÉCIPENT EST DÉPLACÉ OU SI UNE CUILLER OU TOUT AUTRE USTENSILE EST INTRODUIT DANS LE LIQUIDE.

Pour réduire le risque de blessures pour autrui :

- Ne surchauffez pas le liquide.
- Mélangez le liquide avant son réchauffement et au milieu de celui-ci.
- N'utilisez pas de récipient à bords verticaux et à col étroit.
- Après avoir réchauffé, laissez un peu le récipient dans le four à micro-ondes avant de sortir le récipient.
- Faites preuve de grande prudence lors de l'introduction d'une cuiller ou de tout autre ustensile dans le récipient.

▲ MISE EN GARDE!

Ustensiles de cuisson sans danger pour le four à cuisson rapide

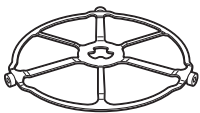

Le **plateau tournant** doit toujours être en place lorsque vous utilisez le four.



Placez les aliments directement sur le **plateau de métal anti-adhésif** pour une cuisson rapide.

Ustensiles de cuisson convenant au four pour cuisiner, griller, réchauffer et rôtir.

- Le four et la porte deviennent très chauds pendant la cuisson rapide.
- Les ustensiles de cuisson deviennent chauds à cause du transfert de chaleur des aliments. Il faut porter des gants thermorésistants pour manipuler les ustensiles de cuisson.
- N'utilisez pas de couvercles, de contenants ou de sacs de cuisson/rôtisserie fabriqués d'aluminium, de papier ciré ou de papier pour la cuisson rapide.
- Ne couvrez pas le plateau tournant, le plateau de cuisson métallique, les plateaux ou toute partie du four de papier métallique. Ceci provoquera la formation d'un arc dans le four.
- Utilisez le plateau de métal anti-adhésif de la même manière qu'un plat peu profond ou qu'un moule.

- Le four et la porte deviennent très chauds pendant que vous cuisinez, grillez, réchauffez ou rôtissez les aliments.
- Les ustensiles de cuisson deviennent chauds. Il faut porter des gants thermorésistants pour manipuler les plats.
- N'utilisez pas de couvercles, de contenants ou de sacs de cuisson/rôtisserie fabriqués d'aluminium, de papier ciré ou de papier pour la cuisson rapide.
- Ne couvrez pas le plateau tournant, le plateau de cuisson métallique, les plateaux ou toute partie du four de papier métallique. Ceci provoquera la formation d'un arc dans le four.
- Utilisez un plateau de métal anti-adhésif de la même manière qu'un plat peu profond ou qu'un moule.
- Utilisez la plaque de cuisson d'aluminium sur le plateau de cuisson métallique et placez-les sur le plateau

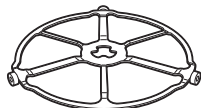

Le **plateau tournant** doit toujours être en place lorsque vous utilisez le four.



Placez les aliments directement sur le **plateau de métal anti-adhésif** pour préparer les aliments à un niveau.

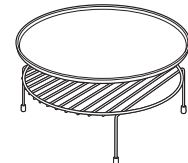

Mettez les aliments directement sur la plaque de cuisson d'aluminium sur le plateau de cuisson métallique et placez-les sur le plateau métallique anti-adhésif en cuisinant à deux niveaux : griller ou rôtir.

- Placez la nourriture directement sur les plateaux pendant la cuisson à moins d'indication contraire du four.
- Vous pouvez utiliser tout plat convenant au four dans votre four à micro-ondes. Les recettes du livre de cuisine Advantium ont été testées dans des plats de verre Pyrex® et des casseroles de céramique Corningware®. Les temps de cuisson et les résultats peuvent varier en utilisant d'autres types de plats pouvant aller au four. Placez-les directement sur les plateaux.
- N'utilisez pas le four pour faire sécher les journaux.
- Utiliser le plateau de verre transparent pour la cuisson rapide produira une performance de cuisson inférieure.

métallique anti-adhésif en cuisinant à deux niveaux : griller ou rôtir.

- Placez la nourriture directement sur les plateaux pendant la cuisson à moins d'indication contraire du four.
- Vous pouvez utiliser tout plat convenant au four dans votre four à micro-ondes. Les recettes du livre de cuisine Advantium ont été testées dans des plats de verre Pyrex® et des casseroles de céramique Corningware®. Les temps de cuisson et les résultats peuvent varier en utilisant d'autres types de plats pouvant aller au four. Placez-les directement sur les plateaux.
- N'utilisez pas le four pour faire sécher les journaux.
- Utiliser le plateau de verre transparent pour cuisiner, griller, réchauffer ou rôtir produira une performance de cuisson inférieure.

▲ MISE EN GARDE!

Ustensile de cuisson convenant au four à micro-ondes

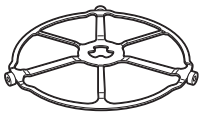

Le **plateau tournant** doit toujours être en place lorsque vous utilisez le four.

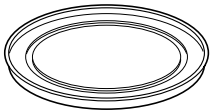

Le **plateau de verre transparent** devrait toujours être en place pour la cuisson à **micro-ondes**.

Assurez-vous d'utiliser des ustensiles de cuisson appropriés pour la cuisson à micro-ondes. La plupart des casseroles de verre, des plats de cuisson, des tasses à mesurer, des ramequins, de vaisselle de la poterie ou de la porcelaine sans bordure ou glaçure de métal à patine métallique peuvent être utilisés. Certains ustensiles de cuisson portent la mention « convient au four à micro-ondes ».

- Placez les aliments ou les contenants pour la cuisson à micro-ondes directement sur le plateau de verre transparent pour les faire cuire.
- Utiliser le plateau de métal anti-adhésif pour la cuisson à micro-ondes produira une performance de cuisson inférieure.
- Si vous n'êtes pas certain qu'un plat puisse aller au micro-ondes, utilisez ce test : placez dans le four le plat à tester et une tasse à mesurer de verre remplie d'une tasse d'eau. Placez cette dernière dans ou près du plat. Faites fonctionner le four de 30 à 45 secondes à température élevée. Si le plat se réchauffe, il ne doit pas être utilisé pour la cuisson à micro-ondes.

S'il reste frais et si seulement l'eau se réchauffe, alors il convient pour le four.

- Les ustensiles de cuisson deviennent chauds en raison du transfert de chaleur des aliments. Il faut porter des gants thermorésistants pour manipuler les plats.
- N'utilisez pas de produits de papier recyclé. Les essuie-tout en papier recyclé, les serviettes et le papier ciré peuvent contenir de petites particules de métal qui pourraient provoquer un arc ou s'enflammer. Vous devez éviter les produits de papier contenant du nylon ou des filaments de nylon car ils peuvent aussi s'enflammer.
- Utilisez le papier aluminium seulement selon les indications de ce guide. Les plateaux téles peuvent être préparés au micro-ondes si les plateaux d'aluminium sont de moins de 3/4 po (1,9 cm) de hauteur et si vous retirez la pellicule couverture et remettez le plateau dans la boîte. Lorsque vous utilisez du papier aluminium dans le four, gardez-le à au moins 1 po (2,54 cm) des parois du four.
- N'utilisez pas le four pour faire sécher les journaux.
- Si vous utilisez un thermomètre à viande pour la cuisson, assurez-vous qu'il convienne aux fours à micro-ondes.
- Certains plateaux de styromousse (comme ceux pour l'emballage de la viande) ont une mince bande de métal incorporée dans la partie inférieure. Au cours de la cuisson au micro-ondes, le métal peut brûler le bas du four ou enflammer un essuie-tout.
- Les essuie-tout, le papier ciré et la pellicule de plastique peuvent servir à couvrir les plats pour conserver l'humidité et éviter les éclaboussures. Assurez-vous d'avoir des ouvertures dans la pellicule pour laisser la vapeur s'échapper.
- Toutes les pellicules de plastique ne conviennent pas aux fours à micro-ondes. Vérifiez l'emballage.
- Les sachets de cuisson et les sacs de plastique bien fermés doivent être fendus, percés ou aérés selon les indications sur l'emballage. Sinon, le plastique pourrait éclater durant ou immédiatement après la cuisson pouvant ainsi mener à des blessures. De même, les contenants de plastique devraient être partiellement découverts parce qu'ils forment une fermeture étanche. Lorsque vous cuisinez avec des contenants bien recouverts d'une pellicule de plastique, retirez avec soin la pellicule et dirigez la vapeur loin des mains et du visage.
- Ustensiles de cuisson de plastique—Les ustensiles de cuisson de plastique conçus pour la cuisson à micro-ondes sont très utiles, mais doivent être utilisés avec soin. Même le plastique convenant pour ce type de cuisson pourrait ne pas supporter la « sur cuisson » comme les matériaux de verre et de céramique et alors le plastique pourrait amollir ou se carboniser s'il est soumis à de courtes périodes de sur cuisson. Pour les expositions plus longues, les aliments et les ustensiles de cuisson pourraient s'enflammer.

Suivez ces directives :

1. Utilisez seulement des plastiques pour les fours à micro-ondes et utilisez-les en vous conformant aux directives du fabricant.
2. Ne mettez pas de contenants vides dans le four à micro-ondes.
3. Ne laissez pas les enfants utiliser des ustensiles de cuisson de plastique sans une étroite surveillance.

▲ MISE EN GARDE!

MESURES DE SÉCURITÉ

- Ne décongelez pas de boissons surgelées dans des bouteilles au col étroit (tout particulièrement les boissons gazeuses). Même si le contenant est ouvert, il pourrait y avoir une accumulation de pression. Le contenant pourrait alors éclater, menant à des blessures possibles.
- Les aliments préparés dans des liquides (comme les pâtes) ont tendance à bouillir plus rapidement que les aliments contenant moins d'humidité. Si ceci se produit, reportez-vous aux directives concernant le nettoyage de l'intérieur du four dans la section « Entretien et nettoyage du four à micro-ondes ».
- Les aliments chauds et la vapeur peuvent provoquer des brûlures. Attention en ouvrant des contenants d'aliments chauds, y compris les sacs de maïs éclaté, les sachets de cuisson et les boîtes. Pour éviter les blessures possibles, dirigez la vapeur loin des mains et du visage.
- Ne faites pas trop cuire les pommes de terre. Elles pourraient se déshydrater et s'enflammer, provoquant des dommages à votre four.
- Évitez de réchauffer la nourriture de bébé dans des contenants en verre, même après avoir retiré le couvercle. Assurez-vous que la nourriture de bébé soit bien cuite. Mélangez-la pour répartir la chaleur uniformément. Attention à l'échaudage en réchauffant la préparation des nourrissons. Le contenant peut être plus frais au toucher que la préparation elle-même. Testez toujours la préparation avant de nourrir le bébé.
- N'essayez pas de grande friture dans le four.

Avis— stimulateurs cardiaques

La plupart des stimulateurs cardiaques sont protégés contre les interférences de produits électroniques, en particulier de fours à micro-ondes. Néanmoins, les personnes ayant un stimulateur cardiaque peuvent consulter leur médecin en cas d'inquiétude.

CONSERVEZ CES DIRECTIVES

What is Advantium?

Advantium Oven

Getting to know Advantium

The new Advantium oven uses breakthrough Speedcook technology to harness the power of light. The Advantium oven cooks the outside of foods much like conventional radiant heat, while also penetrating

the surface so the inside cooks simultaneously. While halogen light is the primary source of power, a “microwave boost” is added with certain foods. Foods cook evenly and fast, retaining their natural moisture.

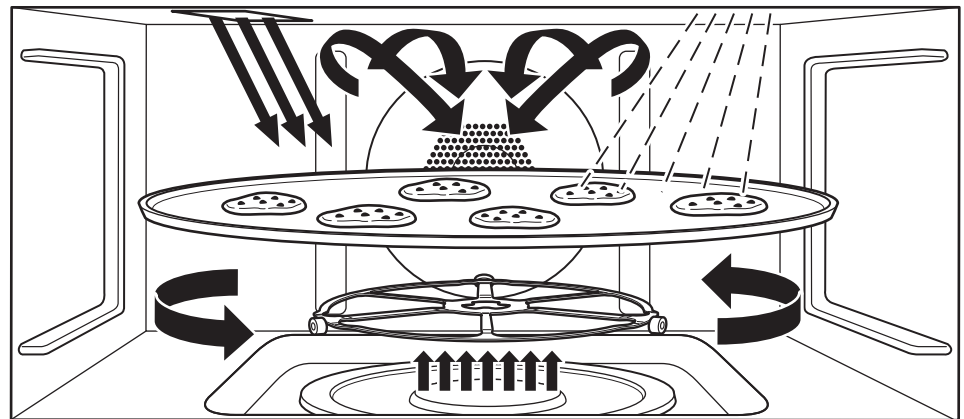

Turntable

- The turntable rotates to ensure even cooking.

Controls

- The oven control contains preset recipes.
- Turn-and-press dial makes menu selection easy.

Halogen Lamp and Ceramic Heaters

- One 500-watt halogen bulb and one 700-watt ceramic heater cook food from above.
- One 375-watt ceramic heater cooks food from below.

Rear Convection Heat Element

- Operates when using bake.

Microwave

- A microwave “boost” is automatically added with certain foods.
- The oven can also be used as a 975-watt microwave oven.

Set the clock

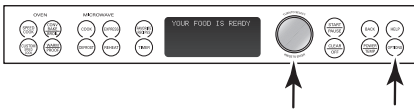

When you first plug in the oven or after a power outage:

1. Turn the selector dial to set the hour. Press the dial to enter.
2. Turn the dial to set the minute. Press the dial to enter.
3. Turn the dial to select AM or PM. Press the dial to enter.

To change the time:

1. Press the OPTIONS pad.
2. Turn the dial to SET CLOCK. Press the dial to enter and follow the display directions to set.

Microwaving with Express



Press EXPRESS repeatedly for 30-second increments of microwave cooking time.

The oven starts immediately.

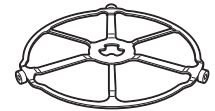

The **turntable** must always be in place when using the oven.

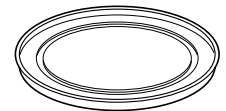

The **clear glass tray** should always be in place when **microwaving**.

Begin speedcooking



1. Press the SPEEDCOOK pad.
2. Turn the dial to FOOD MENU. Press the dial to enter.
3. Turn the dial to select the type of food category you want. Press the dial to enter it.
4. Turn the dial to select the specific food. Press the dial to enter it.
5. Turn the dial to select the amount, size, and/or doneness (if required, the oven will prompt you). Press the dial after each selection.
6. Once the display shows *ADJUST TIME OR START*, either press the dial or start pad to start cooking.

■ Press CLEAR/OFF at any time to stop cooking.

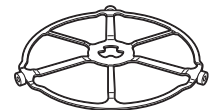

The **turntable** must always be in place when using the oven.



Put food directly on the **nonstick metal tray to speedcook**.

Speedcook Menu Guide

Advantium Oven

Display prompts



After pressing the SPEEDCOOK pad, the oven will prompt you to make several selections, such as the example below.

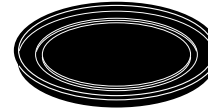

NOTE: When speedcooking, use the nonstick metal tray.

1. Turn the dial until *FOOD MENU* appears. Press the dial to enter.
2. Turn the dial until *POULTRY* appears. Press the dial to enter.
3. Turn the dial until *CHICKEN, BONELESS* appears. Press the dial to enter.
4. Turn the dial to *Select SIZE: MEDIUM (7-9 oz each)*. Press the dial to enter.
5. Turn the dial to *Select amount: 1-2 pieces*. Press the dial to enter.
6. Use *NON-STICK METAL TRAY* is displayed.

Preset speedcook menu selections

■ After a cooking cycle has been completed, use the Resume feature to cook for additional time.

■ To review settings during cooking, press the selector dial.

Food Category	Menu Selection	Food Category	Menu Selection
Appetizers	Bagel Bites Cheese Sticks Egg Rolls (Frozen) Hot Dip (2-4 Cups) Jalapeno Poppers Meat Balls (Frozen) Nachos Nuts Roasted Onion Rings Pizza Rolls Soft Pretzels (Frozen)	Meats	Filet Mignon Hamburger Lamb Chops Pork Chops Roast - Pork Roast - Beef Ribeye Steak Sirloin Steak Strip Steak T-Bone Steak Tenderloin
Breads	Bagels (frozen) Biscuits Bread Sticks Cheese Bread Crescent Rolls Dinner Rolls Garlic Bread Quick Bread (9x5) Sweet Rolls/Danish Taco Shells (boxed) Texas Toast	Pizza	Deli/Fresh Use Precooked Crust Frozen Pizza
Breakfast	Bagels (frozen) Belgian Waffles Breakfast Pizza Casserole (egg 7x11) Coffee Cake French Toast Pancakes (frozen) Hashbrown Patties Rolls (refrigerated) Sausage Biscuit Sausage Strudel (frozen) Sweet Rolls/Danish Turnovers Waffles (frozen)	Potatoes	Baked Potato Hashbrown Patties Frozen Fries Frozen Nugget Sweet Potato/Yam
Desserts	Brownies Cakes (mix 9x13) Cobbler (fresh 7x11) Coffee Cake Cookies Pie (fresh fruit) Rolls (refrigerated) Turnovers	Poultry	Chicken, Bone-In Chicken, Boneless Chicken Fillet (frozen) Chicken Finger (frozen) Chicken, Fried (frozen) Chicken Nugget (frozen) Chicken Patty (frozen) Chicken Tender (frozen) Chicken Wings (frozen) Chicken, Whole Turkey
Entree	Burritos (frozen) Chimichanga Casserole Egg Rolls (frozen) Enchilada (fresh) Lasagna Meatloaf (9x5) Quesadillas (fresh) Stuffed Peppers (6)	Sandwich	Corn Dog (frozen) Crescent Roll Hot Dog Grilled Sandwich Hot Dog in a Bun Pocket Sandwich Taqitos (frozen)
		Seafood	Cod Fillets Fish Sticks (frozen) Frozen Breaded Lobster Tails Orange Roughy Fillet Salmon Sea Bass Shellfish Swordfish Steak Talapia Tuna Steaks Whitefish
		Side Dish	Refried Beans (16 oz) Roasted Asparagus Roasted Bell Pepper Roasted Chilis (6) Roasted Corn Roasted Garlic Roasted Mixed Vegetables Stuffing (mix) Stuffed Mushrooms Stuffed Tomatoes

Oven features

Throughout this manual, features and appearance may vary from your model.

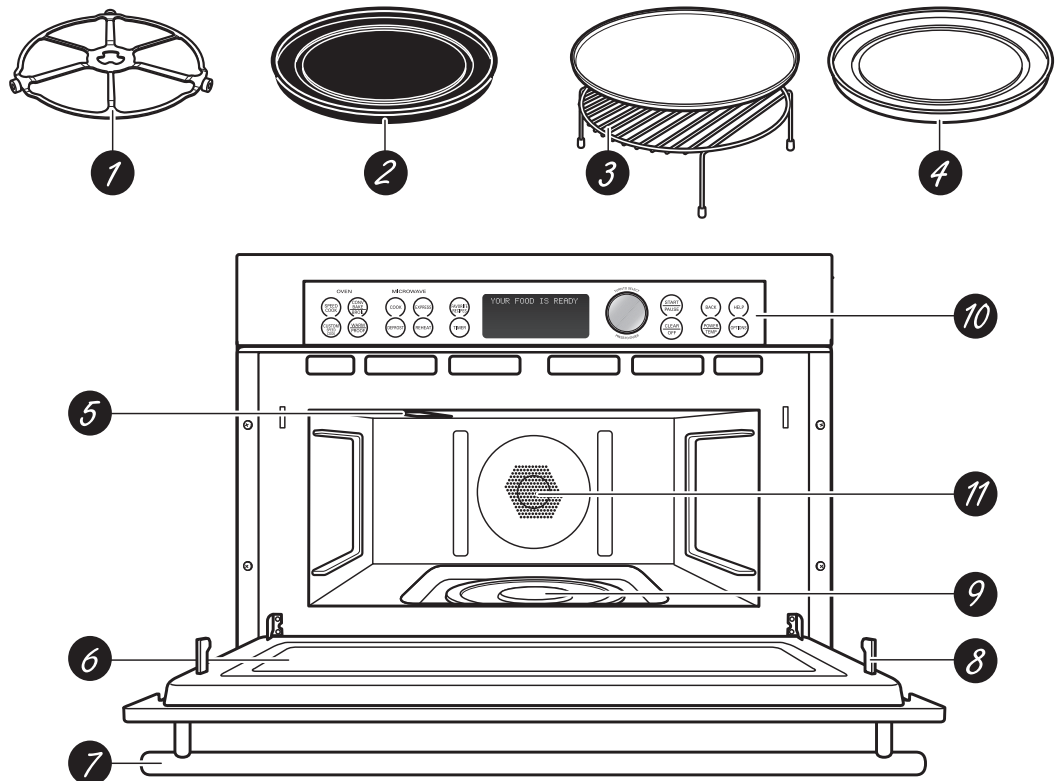

- 1** *Turntable*
The turntable must always be in place, on the oven floor, for all cooking. Be sure the turntable is seated securely over the spindle in the center of the oven.

2 *Nonstick Metal Tray*
Put food directly on the nonstick metal tray and place on the turntable when using the speedcook and bake features.

3 *Wire Oven Rack and Aluminum Baking Sheet*
Put food directly on the aluminum baking sheet on the wire oven rack, and place them on the nonstick metal tray, when baking on two levels, broiling or toasting foods.

4 *Clear Glass Tray*
Place on the turntable when using the microwave features. Place food or microwave-safe cookware directly on the tray.
- 5** *Upper Halogen Lamp/Ceramic Heater*
Operates when using speedcook or broil.

6 *Window*
Allows cooking to be viewed while keeping microwaves confined in the oven.

7 *Door Handle*
Pull to open the door. The door must be securely latched for the oven to operate.

8 *Door Latches*

9 *Lower Ceramic Heater*
Operates when using speedcook.

10 *Control Panel*
The pads used to operate the oven are located on the control panel.

11 *Rear Convection Heat Element*
Operates when using bake.

Cooking controls

With your Advantium oven, you can cook with high-intensity halogen lights, ceramic heaters and convection heating elements, and/or conventional microwave energy.

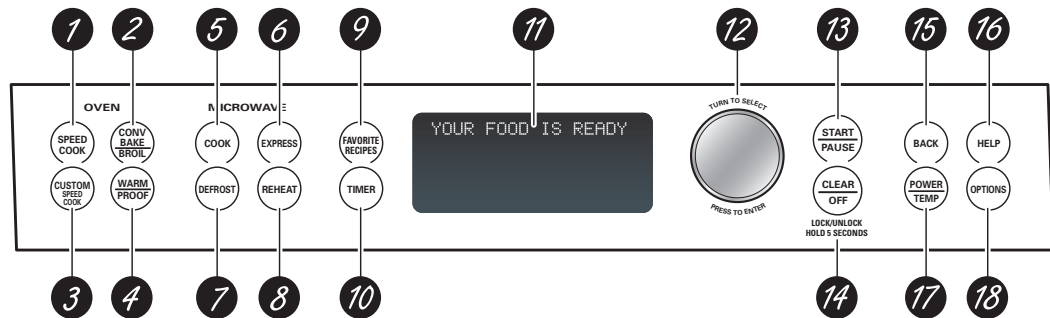

- 1 SPEEDCOOK/Repeat Last**
Press this pad to access the preset speedcook menu. Press and hold for 3 seconds to repeat the last cooking selection.
- 2 CONV BAKE/BROIL**
Press this pad to convection bake, broil or toast.
- 3 CUSTOM SPEEDCOOK**
Press this pad to set your own speedcook program.
- 4 WARM/PROOF**
Select WARM to keep hot, cooked foods at serving temperature.
Select PROOF to set for a warm environment useful for rising yeast-leavened products.
- 5 COOK (Microwave)**
Press this pad to microwave food that is not in the FAVORITE RECIPES section.
- 6 EXPRESS (Microwave)**
Press for 30 seconds of microwave cooking time. Each time the pad is pressed adds an additional 30 seconds to the remaining cooking time. The oven starts immediately.
- 7 DEFROST (Microwave)**
Press this pad to defrost, soften or melt frozen foods.
- 8 REHEAT (Microwave)**
Press this pad to reheat servings of previously cooked foods or a plate of leftovers.
- 9 FAVORITE RECIPES**
Press this pad to add, edit (change) or remove a recipe from the memory.
- 10 TIMER**
Press this pad to set the minute timer.
- 11 Display**
Shows and instructs the use of all features on the oven.
- 12 SELECTOR DIAL**
Turn to select, Press to enter. First turn, then press the dial to make option, food power level or temperature selections. Also use the dial to increase (turn clockwise) or decrease (turn counterclockwise) cooking times.
- 13 START/PAUSE**
Press this pad to start or pause any cooking function.
- 14 CLEAR/OFF**
Press this pad to cancel **ALL** oven programs except the clock and timer.
- 15 BACK**
Press this pad to step back one or more levels in the program process, such as when entering custom recipes.
- 16 HELP**
Press this pad to find out more about your oven's features.
- 17 POWER/TEMP**
During cooking, press this pad and turn/press the selector dial to change the microwave power level, the convection bake temperature or the speedcook temperature by adjusting the upper and lower lamp and heater settings.
- 18 OPTIONS**
Press this pad to set the **Clock** and access the **Beeper Volume, Clock Display ON/OFF, Display Scroll Speed, Delay Start** and **Reminder** features.

Using speedcook features

⚠ CAUTION: When using speedcook programs, remember that the oven, door and dishes will be very hot!

Prior to the first use of your oven, the clock must be set. See the Advantium Quick Start section.

Before you begin, make sure the turntable is in place. Use the nonstick metal tray and your own glass or ceramic cookware, if needed.

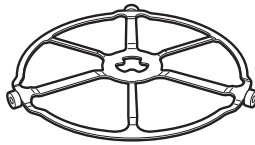

The **turntable** must always be in place when using the oven.

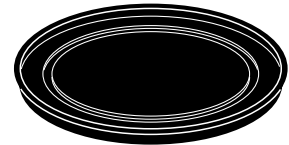

Put food directly on the **nonstick metal tray to speedcook**.

SPEEDCOOK PRESET FOOD SELECTIONS:

■ Appetizers	■ Desserts	■ Pizza	■ Sandwich
■ Breads	■ Entrees	■ Potatoes	■ Seafood
■ Breakfast	■ Meats	■ Poultry	■ Side Dish

To use a preset speedcook menu



Advantium is already preset to cook over 175 popular dishes.

1. Press the speedcook pad.
If no selection is made within 15 seconds, the display will revert back to the time of day.
2. Turn the selector dial to select the type of food category you want. Press the dial to enter.
3. Turn the selector dial to select the specific food (menu selection). Press the dial to enter.
4. Turn the selector dial to select amount, size and/or doneness (if required, the oven will prompt you). Press the dial after each selection.

5. Once the display shows **ADJUST TIME** or **START**, either press start or the selector dial to start cooking.

*Turn the food over when the oven signals **TURN FOOD OVER** (for certain foods).*

*When the oven signals **CHECK** for **DONENESS**, check to see if your food is done to your liking (for certain foods).*

To review settings during cooking, press the selector dial.

*If you enter an undesired selection at any time, simply press the **BACK** pad and reenter the desired selections.*

■ *Early in a speedcook program, you will see **OPTIMIZING COOK TIME** on the display. The oven automatically senses the electrical voltage level in your home and adjusts the cooking time up or down for proper cooking.*

■ *If the door is opened during cooking, the oven will stop and **PAUSE** will appear in the display. Close the door and press the **START/PAUSE** pad to resume cooking.*

■ *At anytime during cooking you can turn the selector dial to change the*

*cooking time. You can change power levels by pressing **POWER/TEMP**.*

■ *To ensure consistent cooking results, the oven may adjust power levels downward if the oven is hot at the beginning of a program.*

■ *At the end of cooking, the automatic fan may continue to run for a short time to cool internal components.*

■ *To cook for additional time after a cooking cycle has been completed, use the resume feature.*

Cooking tips for great tasting results

To ensure consistent and even browning when cooking foods directly on the nonstick metal tray, arrange food as shown below.

Foods can touch but should not overlap.

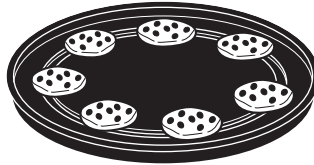

Circular pattern
(Example: biscuits, cookies)



Side by side pattern
(Example: meats and poultry)



Spoke pattern
(Example: crescent rolls, breadsticks)

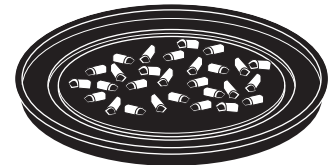

Single layer
(Example: appetizers)

Fresh meat, chicken, fish or seafood that has been frozen should be **thawed before cooking** (the microwave defrost feature can be used). For other frozen prepackaged foods, follow package directions.

Repeat last



Use this time saving feature for cooking repetitive items like cookies or appetizers.

NOTE: The last program used is stored for two hours.

1. Press and hold the SPEEDCOOK pad for 3 seconds.
2. The last preset food will be displayed.
3. Press the START/PAUSE pad or the selector dial to start cooking.

Resume feature

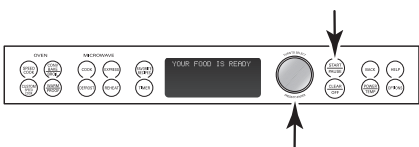

1. If your food needs to cook a bit longer, you can restart the oven by pressing the START/PAUSE pad or selector dial.
2. **RESUME COOKING** will be displayed and the oven will restart immediately at 10% of the original time.

The program stays in memory for 10 minutes. After that you will need to begin the program again. See *To use a preset speedcook menu.*

Speedcook power level



Advantium uses power from a high intensity halogen light, ceramic heaters and microwaves to cook food from the top, bottom and interior simultaneously to seal in moisture and flavor.

When using the preset speedcook recipes on the food menu, the power levels are already selected for you. However, these power levels can be adjusted before or during cooking. See POWER/TEMP in the Cooking Controls section. The custom speedcook feature allows you to speedcook items not on the preset food menu by selecting your own cook time and power level settings.

Each power level gives you heater power and microwave energy for a certain percentage of the time.

UPPER POWER (U) controls both the upper heater and microwave power. A higher **UPPER POWER** setting will utilize more upper heater power, browning food faster on top. A lower **UPPER POWER** setting utilizes more microwave power, causing food to cook more evenly throughout.

Select a higher setting for foods such as pizza and baked goods. Select a lower setting for foods such as casseroles, meat and fish.

LOWER POWER (L) controls the lower heater.

Select a higher setting to brown foods more on the bottom. Select a lower setting for less browning on the bottom.

1. Press the SPEEDCOOK pad and turn the dial to select FOOD MENU or FAVORITE RECIPES, or press CUSTOM SPEEDCOOK to manually set power level and timer. Press the dial to enter.
2. Turn the dial to select a food, time or power level as prompted. Press the dial to enter.
3. To change the power level when prompted by the display, turn the dial clockwise to increase or counterclockwise to decrease the upper power level. Press the dial to enter.
4. Microwave levels are set automatically based on the upper and lower lamp settings.
5. Press the START/PAUSE pad or the selector dial to start cooking.

If you do not want to change one of the settings, just press the dial to move to the next selection.

NOTE: Be careful when adjusting power levels so that you do not over- or undercook food.

Follow these general guidelines when selecting the best U and L settings for your favorite recipes:

U = Select a higher setting for thin foods requiring a golden brown top (example: fish fillets, toast, boneless chicken breasts). Select a lower setting for thicker foods and foods with high sugar or fat content (example: cakes, roasts).

L = Select a higher setting for thick or dense foods that may not cook quickly in the center (example: casseroles). Select a lower setting for thin foods (example: cookies) and foods containing high fat or sugar content (example: pastry, cakes).

Speedcook cookware

- Follow cookware suggestions on the oven display or in the cookbook or cooking guide.
- Cookware will become hot because of heat transferred from the heated food. Oven mitts will be needed to handle the cookware.
- Place food directly on the nonstick metal tray when cooking, unless prompted by the oven to do otherwise.
- Use the nonstick metal tray in the same way you would use a shallow baking pan or baking tray.
- In addition to the cookware provided, you can use non-metal casserole dishes, pie plates and other heat-safe cookware. Place them directly on the turntable.



- Be sure to select a size that will rotate easily.
- Place the nonstick metal tray on the turntable. Place glass or ceramic cookware on the tray.
- Do not use cookware or coverings made of paper, plastic or foil when cooking during a speedcook cycle.

Custom speedcook



Advantium gives you the flexibility to cook your favorite dishes.

If you want to cook a food item that is not among the preset selections, use custom speedcook.

1. Press the CUSTOM SPEEDCOOK pad.

If no entries are made within 15 seconds, the display will revert back to the time of day.

2. Turn the selector dial to select the cooking time. Press the dial to enter.

The display will prompt you to select the power level(s).

3. Turn the dial clockwise to increase or counterclockwise to decrease the upper power level. Press the dial to enter.

4. Turn the dial to change the lower power level. Press the dial to enter.

5. Press the START/PAUSE pad or press the selector dial to start cooking.

For power level and cooking time suggestions, use your cooking guide or cookbook.

*Favorite recipe—
to enter
and save*

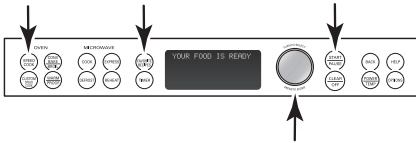

Add and save up to 30 of your own Speedcook or microwave recipes, or preset Speedcook menu recipes as a favorite recipe. Once it's done, you can quickly recall your favorite so that your food cooks just the way you want it every time!

1. Press the FAVORITE RECIPES or the SPEEDCOOK pad.
2. Turn the dial until *FAVORITE RECIPES* appears. Press the dial to enter. (Skip this step if the FAVORITE RECIPES pad was pressed in step 1.)
3. Turn the dial until *ADD RECIPE* appears. Press the dial to enter.
4. Turn the dial to *COPY SPEED RECIPE* or to *ADD NEW RECIPE*. Press the dial to enter.

If *COPY SPEED RECIPE* was selected, turn dial to food type(s) and press the FAVORITE RECIPES pad to enter and save the recipe.

If *ADD NEW RECIPE* was selected, turn the dial to select *SPEEDCOOK* or *MICROWAVE* recipe. Press the dial to enter and continue with these steps.

5. *SELECT COOK TIME* appears. Turn the dial to select the cooking time. Press the dial to enter.

The display will prompt you to select the power level(s).

6. Turn the dial clockwise to increase or counterclockwise to decrease the power level(s). Press the dial to enter.

For power level and cooking time suggestions, use your cooking guide or cook book.

7. *SPELL THE FOOD NAME* appears. Turn the dial to the first letter of your food description and press the dial to enter. Continue this process to spell the rest of the food name. Press the START/PAUSE pad to save the recipe and its name.

*Favorite recipe—
to find
and use*

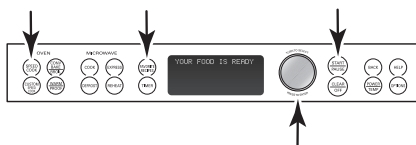

To find and use stored favorite recipes:

1. Press the FAVORITE RECIPES or the SPEEDCOOK pad.
2. Turn the dial until *FAVORITE RECIPES* appears. Press the dial to enter.
3. Turn dial to *USE FAVORITE RECIPE* and press to enter.

4. The recipe names you entered will appear.
5. Turn dial until the recipe you want is displayed and press the dial to enter.
6. Press the START/PAUSE pad or press the selector dial to start cooking.

Favorite recipe— to adjust or change

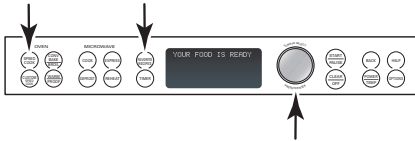

To adjust or change stored custom speedcook recipes:

1. Press the FAVORITE RECIPES or the SPEEDCOOK pad.
2. Turn the dial until FAVORITE RECIPES appears. Press the dial to enter.
3. Turn the dial until *EDIT RECIPE* appears. Press the dial to enter.
4. Turn the dial to the recipe you want to change. Press the dial to enter. Current settings appear.

5. Press the dial to edit.
6. The display will prompt you to select the power level(s) and edit the name. Turn the dial and press to enter the appropriate settings.

For power level and cooking time suggestions, use your cooking guide or cook book.

Favorite recipe— to delete

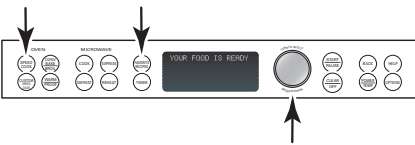

To delete stored custom speedcook recipes:

1. Press the FAVORITE RECIPES or the SPEEDCOOK pad.
2. Turn the dial until FAVORITE RECIPES appears. Press the dial to enter.
3. Turn the dial until *DELETE RECIPE* appears and press the dial to enter.
4. Turn dial to the recipe you want to delete and press the dial to enter.

Things that are normal

Cooking Times

- When speedcooking preprogrammed foods, you may see *OPTIMIZING COOK TIME* in the display several seconds after you press START/PAUSE. The oven automatically senses the electrical voltage level in your home and adjusts the cooking time up or down for proper cooking.

Fan/Vent

- The fan will be on during cooking. At the end of cooking, the automatic fan may continue to run for a short time, and the display will read *Oven is Cooling*. The fan will automatically shut off when the internal parts of the oven have cooled.
- The oven vent will emit warm air while the oven is on.

Lights

- When the oven is on, light may be visible around the door or outer case.
- The halogen lights will dim and cycle on and off during a speedcook cycle, sometimes even at full power levels. This is normal. The oven senses the heat level and adjusts automatically.

Oven Heat

- No preheating time is required during Speedcook cycles. The oven begins cooking immediately.
- The door and inside of the oven will be very hot. Use caution when opening the door and removing food.
- Do not use cookware or coverings made of paper, plastic or foil when cooking during a speedcook cycle.
- When cooking for an extended period of time, the oven may automatically reduce the power levels to maintain the appropriate level of oven heat.

Sounds

- Clicks and a fan blowing are normal sounds during cooking. The relay board is turning components on and off.

Convection Baking, Broiling and Toasting

Convection baking allows you to cook foods the same way as a conventional oven, using a heating element to raise the temperature of the air inside the oven. Any oven temperature from 250°F to 450°F may be set.

Broiling allows you to broil foods in the same way as a conventional oven.

Toasting allows you to toast foods the same way as a conventional oven.

A fan gently circulates heated air throughout the oven, over and around the food. Because the heated air is kept constantly moving, not permitting a layer of cooler air to develop around the food, some foods cook slightly faster than in regular oven cooking.

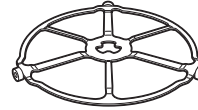

The **turntable** must always be in place when using the oven.

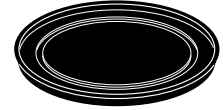

Put food or oven-safe cookware directly on the **nonstick metal tray to bake**.

Before you begin, make sure the turntable is in place. Use the nonstick metal tray at all times when baking.

⚠ CAUTION: When baking, remember that the oven, door and dishes will be very hot!

How to Convection Bake

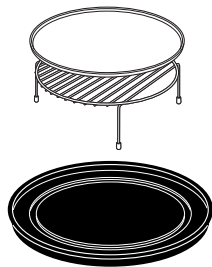

For two-level baking, place food in a metal baking dish or directly on the nonstick metal tray. Place the aluminum baking sheet or your baking dish with food on top of the wire rack. Stand the rack with food on the metal tray.

1. Press the CONV BAKE/BROIL pad.
2. Press the dial to select BAKE.
3. Turn the dial to set the oven temperature and press to enter.

To bypass preheating:

1. When the prompt shows *PREHEAT THE OVEN?* turn the dial to NO. Press the dial or press START/PAUSE to begin cooking.
2. Place the food in the oven, turn the dial to set the cook time and press to enter. The oven starts cooking immediately. When cooking is complete, the oven will signal and turn off.

To preheat:

1. When the prompt shows *PREHEAT THE OVEN?* turn the dial to YES. Press the dial or press START/PAUSE to begin cooking. The oven starts preheating immediately. Do not place the food in the oven. (You will be prompted to enter the cook time, after the oven is preheated.)

2. When the oven is finished preheating, it will signal. If you do not open the door within 1 hour, the oven will turn off automatically. Open the oven door and, using caution, place the food in the oven.
3. Close the oven door. Turn the dial to set the cook time and press to enter and start cooking. When cooking is complete, the oven will signal and turn off.

You may change the oven temperature during preheating by pressing the POWER/TEMP pad and turning the dial to select the new temperature.

If the oven door is opened during cooking, PAUSE will appear in the display. Close the door and press START/PAUSE.

Cook times are shown in minutes and can be a maximum of 179 minutes. Time can be changed during cooking by turning the dial.

How to Broil or Toast



Put food directly on the aluminum baking sheet on the wire oven rack, and place them on the nonstick metal tray, when broiling or toasting foods.

1. Press the CONV BAKE/BROIL pad.
2. Turn the dial to BROIL or TOAST and press to enter.

To bypass preheating:

1. When the prompt shows *PREHEAT THE OVEN?* turn the dial to NO. Press the dial or press START/PAUSE to begin cooking.
2. Place the food in the oven, turn the dial to set the cook time and press to enter. Press the dial to start cooking. When cooking is complete, the oven will signal and turn off.

To preheat:

1. When the prompt shows *PREHEAT THE OVEN?* turn the dial to YES. Press the dial or press START/PAUSE to begin cooking.

The oven starts preheating immediately. Do not place the food in the oven. (You will be prompted to enter the cook time, after the oven is preheated.)

2. When the oven is finished preheating, it will signal. If you do not open the door within 1 hour, the oven will turn off automatically. Open the oven door and, using caution, place the food in the oven.
3. Close the oven door. Turn the dial to set the cook time and press to enter and start cooking. When cooking is complete, the oven will signal and turn off.

If the oven door is opened during cooking, PAUSE will appear in the display. Close the door and press START/PAUSE.

Warming

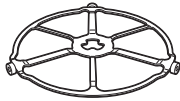

The **turntable** must always be in place when using the oven.



Put food directly on the **nonstick metal tray** to warm.

Tips for Crisp Foods:

- Leave food uncovered.
- Do not use plastic containers or plastic wrap.
- Preheat prior to use according to recommended times.

Tips for Moist Foods:

- Cover food with lid or aluminum foil.
- Do not use plastic containers or plastic wrap.
- Preheat prior to use according to recommended times.

The **WARM** feature will keep hot, cooked foods at serving temperature. Always start with hot food. Use cookware and utensils that can withstand temperatures up to 230°F.

1. Press the WARM/PROOF pad.
2. Turn the dial to select HOLD FOOD WARM. Press the dial to enter.
3. Turn the dial to select the oven temperature. See the chart and tips below. Press the dial to enter.

LOW140°-160°F
 MEDIUM160°-195°F
 HIGH195°-230°F

4. Turn the dial to select the level of moisture you want. See the chart and tips below. Press the dial to enter.

If the oven door is opened during warming, **PAUSE** will appear in the display. Close the door and press **START/PAUSE**.

To Crisp Stale Items:

- Place food or dishes directly on the black metal tray.
- Preheat on LOW setting and select CRISP.
- Check crispness after 45 minutes. Add time as needed.

Temperature and Moisture Selection Chart

Food Type	Control Setting	Moisture Setting
Bread, hard rolls	MEDIUM	CRISP
Bread, soft rolls	MEDIUM	MOIST
Casseroles	MEDIUM	MOIST
Fried foods	HIGH	CRISP
Meats* and fish	MEDIUM	CRISP
Pancakes, waffles	HIGH	CRISP
Pizza	HIGH	CRISP
Potatoes, baked	HIGH	CRISP
Potatoes, mashed	MEDIUM	MOIST
Poultry	HIGH	MOIST
Tortilla Chips	LOW	CRISP
Vegetables	MEDIUM	MOIST

* USDA/FSIS recommends an internal temperature of 145°F as the minimum doneness for beef. Use a portable meat thermometer to check internal temperatures.

Proofing

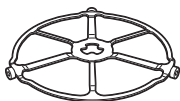

The **turntable** must always be in place when using the oven.



Put bread dough in a bowl/bread pan and place on the **nonstick metal tray** to proof.

The **proofing** feature automatically provides the optimum temperature for the proofing process, and therefore does not have a temperature adjustment.

1. Press the WARM/PROOF pad.
2. Turn the dial to select **PROOF BREAD**. Press the dial to enter. The oven starts proofing immediately and shows the amount of proofing time completed.

- To avoid lowering the oven temperature and lengthening proofing time, do not open the oven door unnecessarily.
- Check bread products early to avoid over-proofing.

NOTES:

- Do not use the proofing mode for warming food or keeping food hot. The proofing oven temperature is not hot enough to hold foods at safe temperatures. Use the **WARM** feature to keep food warm.
- Proofing will not operate if the oven is too hot. Allow the oven to cool before proofing.

Using the microwave features

Make sure the turntable and clear glass tray are in place. Place food or microwavable container directly on the clear glass tray to cook your food.

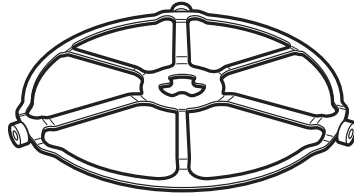

The **turntable** must always be in place when using the oven.

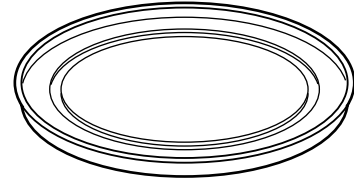

The **clear glass tray** should always be in place when **microwaving**.

Cookware

■ Make sure that cookware is suitable for microwaving.

■ Place food or microwavable container directly on the clear glass tray to cook your food.

MICROWAVE PRESET SELECTIONS:

■ Cook

- By Food Type
- By Time
- By Time 1 & 2
- Delay Start
- Heat/Reheat
- Beverage
- Melt
- Slow Cook
- Soften

■ Defrost

- 1.0 lb Quick
- By Time
- By Food Type
- By Weight
- Delay Start
- Melt
- Soften

■ Reheat

- Beverage
- Casserole
- Chicken
- Pasta
- Pizza
- Plate of Food
- Rice
- Soup
- Steaks/Chops
- Vegetables

How to use preset microwave selections



1. Press the microwave COOK, DEFROST or REHEAT pad.

If no selection is made within 15 seconds, the display will revert back to the time of day.

2. Turn the dial to find the food you want to cook, defrost or reheat. Press the dial to enter.
3. Turn the selector dial to select the type, amount, weight and/or size. (As required, the oven will prompt you.) Press the dial after each selection.
4. Press the dial or the START/PAUSE pad to start cooking.

To review settings during cooking, press the selector dial.

If the door is opened during cooking, the oven will stop and PAUSE will appear in the display. Close the door and press START/PAUSE to resume cooking.

If you enter an undesired selection at any time, simply press the BACK pad and reenter the desired selections.

Cook By Time and Cook By Time 1 & 2



Use **COOK BY TIME** and **COOK BY TIME 1 & 2** to microwave food that is not in the recipe section and at the time(s) you set.

■ The power level is automatically set at high, but you can change it for more flexibility.

1. Press the **COOK** pad.
2. Turn the dial to select **COOK BY TIME** or **COOK BY TIME 1 & 2** and press the dial to enter.
3. Turn the dial to set the cook time and press the dial to enter.

If you selected **COOK BY TIME 1 & 2**, turn the dial to set the second cook time and press the dial to enter.

NOTE: To change the power level if you don't want full power, press the **POWER/TEMP** pad after entering the time(s). Turn the dial to select and press the dial to enter.

4. Press the dial or the **START/PAUSE** pad to start cooking.

You may open the door during **COOK BY TIME** and **COOK BY TIME 1 & 2** to check the food. Close the door and press **START/PAUSE** to resume cooking.

Express

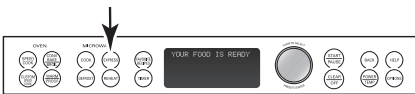

Press **EXPRESS** repeatedly for 30 second increments of microwave cooking time. Oven starts immediately.

Microwave power level(s)



1. First, follow directions for **COOK BY TIME**, **COOK BY TIME 1 & 2**, **DEFROST BY TIME** or **EXPRESS**.
2. Press the **POWER/TEMP** pad.
3. Turn the dial clockwise to increase and counterclockwise to decrease the power level. Press the dial to enter.

4. Press the dial or the **START/PAUSE** pad to start cooking.

■ You can change the power level before or during a cooking program.

Here are some examples of uses for various power levels:

High 10: Fish, bacon, vegetables, boiling liquids.

Med-High 7: Gentle cooking of meat and poultry; baking casseroles and reheating.

Medium 5: Slow cooking and tenderizing for stews and less tender cuts of meat.

Low 2 or 3: Defrosting, simmering, delicate sauces.

Warm 1: Keeping food warm, softening butter.

Favorite recipes

See the Favorite recipe sections in the Speedcook section of this book for instructions on how to save, use, change or delete a favorite recipe.

Cooking tips

- When cooking bacon, layer strips on a plate. Cover each layer with a paper towel.
- When cooking vegetables, use a microwave-safe casserole or bowl. Cover with a microwave-safe lid or vented plastic wrap.

- For frozen vegetables, follow the package instructions for adding water.
- For fresh vegetables, add 2 tablespoons of water for each serving.

Defrost by food type



Auto Defrost automatically sets the defrosting times and power levels to give even defrosting results for meats, poultry and fish weighing up to 6 pounds.

1. Remove food from the package and place it on a microwave-safe dish.
2. Press the DEFROST pad.
3. Turn the dial to *DEFROST BY FOOD TYPE*. Press the dial to enter.
4. Turn the dial to select food type. Press the dial to enter.
5. Turn the dial to the food weight, using the Conversion Guide at right. For example, dial 1.2 for 1.2 pounds (1 pound, 3 oz.) Press the dial to enter.
6. Press the dial or START/PAUSE pad to start defrosting.
7. Turn the food over when the oven signals *TURN FOOD OVER*.

- Remove defrosted meat or shield warm areas with small pieces of foil for even defrosting.
- After defrosting, most meats need to stand 5 minutes to complete defrosting. Large roasts should stand for about 30 minutes.

Conversion Guide

If the weight of food is stated in pounds and ounces, the ounces must be converted to tenths (.1) of a pound.

Weight of Food in Ounces	Enter Food Weight (tenths of a pound)
1-2	.1
3	.2
4-5	.3
6-7	.4
8	.5
9-10	.6
11	.7
12-13	.8
14-15	.9

Defrost by time



Use Time Defrost to defrost for a selected length of time.

1. Press the DEFROST pad.
2. Turn the selector dial to *DEFROST BY TIME*. Press the dial to enter.
3. Turn the dial to select the time you want. Press the dial to enter.
4. Press the dial or START/PAUSE pad to start defrosting.
5. Turn the food over when the oven signals *TURN FOOD OVER*.

Power level is automatically set at 3, but can be changed. To change the power levels, see the Microwave Power Level(s) section. You can defrost small items quickly by raising the power level after entering the time. Power level 7 cuts the total defrosting time in about half; power level 10 cuts the total time to about 1/3. When defrosting at high power levels, food will need more frequent attention than usual.

Defrosting tips

Use *DEFROST BY FOOD TYPE* for meat, poultry and fish. Use *DEFROST BY TIME* for most other frozen foods.

- Foods frozen in paper or plastic can be time defrosted in the package, but foods should be taken out of the package when using *DEFROST BY FOOD TYPE*. Closed packages should be slit, pierced or vented **after** food has partially defrosted. Plastic storage containers should be partially uncovered.
- Family-size, prepackaged frozen dinners can be defrosted and microwaved. If the food is in a foil container, transfer it to a microwave-safe dish.
- Foods that spoil easily should not be allowed to sit out for more than one hour after defrosting. Room temperature promotes the growth of harmful bacteria.
- For more even defrosting of larger foods, such as roasts, use *DEFROST BY TIME*. Be sure large meats are completely defrosted before cooking.
- When defrosted, food should be cool but softened in all areas. If still slightly icy, return to the microwave very briefly, or let it stand a few minutes.

Microwave sensor cooking

The sensor feature detects the increasing humidity released during cooking. The oven automatically adjusts the cooking time to various types and amounts of food.

Do not use the Sensor Features twice in succession on the same food portion—it may result in severely overcooked or burnt food. If food is undercooked after the first countdown, use **COOK BY TIME** for additional cooking time.

The proper containers and covers are essential for best sensor cooking.

- Always use microwave-safe containers and cover them with lids or vented plastic wrap. Never use tight sealing plastic containers—they can prevent steam from escaping and cause food to overcook.
- Be sure the outside of the cooking containers and the inside of the oven are dry before placing food in the oven. Beads of moisture turning into steam can mislead the sensor.
- Beverages are best heated uncovered.

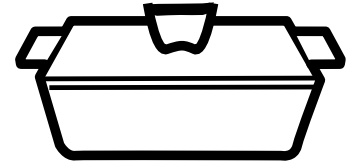

Covered

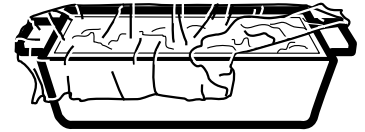

Vented



Dry off dishes so they don't mislead the sensor.

MICROWAVE SENSOR PROGRAMS:

- **Ground Meat**
- **Popcorn – Prepackaged microwave popcorn, 3.0 oz. to 3.5 oz.**
- **Soup**
- **Rice**
- **Vegetables (Canned, Fresh, Frozen)**
- **Chicken Reheat**
- **Pasta Reheat**
- **Plate of Food Reheat**
- **Soup Reheat**
- **Vegetable Reheat**

To use all sensor programs

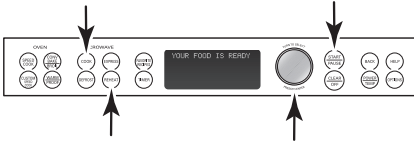

Advantium's microwave mode features sensor cooking. The oven automatically senses when food is done and shuts itself off—eliminating the need to program cook times and power levels.

1. Press the COOK pad and turn the dial to COOK BY FOOD TYPE. Press the dial to enter. Or press the REHEAT pad.
2. Turn the dial to select the food you want. Press the dial to enter.
3. Press the dial or press the START/PAUSE pad to start cooking.

Do not open the oven door until time is counting down in the display. If the door is opened, close it and press START/PAUSE immediately. If the food is not done enough, use COOK BY TIME in the microwave selector to cook for more time.

NOTE: Do not use the Sensor Features twice in succession on the same food portion—it may result in severely overcooked or burnt food.

- If you have been speedcooking and the oven is already hot, it may indicate that it is too hot for sensor cooking. Of course, you can always continue with COOK BY TIME or SPEEDCOOK.

NOTE: If the oven is too hot then it will automatically change to time cooking.

- To shorten or lengthen the cook time, wait until the time countdown shows in the display. Then turn the dial to add or subtract time.
- If you open the door while Sensor Cooking, SENSOR ERROR will appear. Close the door, press START/PAUSE to begin again.

Notes about the Reheat program:

Reheated foods may have wide variations in temperature. Some areas may be extremely hot.

It is best to use COOK BY TIME and not REHEAT for these foods:

- Bread products.
- Food that must be reheated uncovered.
- Foods that need to be stirred or turned.
- Foods calling for a dry look or crisp surface after reheating.

Things that are normal

Interference

- TV/radio interference might be noticed while using the microwave. Similar to the interference caused by other small appliances, it does not indicate a problem with the microwave. Move the radio or TV as far away from the microwave as possible, or check the position of the TV/radio antenna.

Lights

- The oven cavity light will come on during a microwave cooking cycle.

Oven Heat

- Cookware may become hot because of heat transferred from the heated food. Oven mitts may be needed to handle the cookware.
- Steam or vapor may escape from around the door.

“COOK TIME COMPLETED”

To remind you that you have food in the oven, the oven will display *COOK TIME COMPLETED* and beep once a minute until you either open the oven door or press the CLEAR/OFF pad.



Features under the OPTIONS pad



Clock:

The clock must be set before you can use your oven for the first time (see *Quick Start for instructions*).

1. To change the clock time, press the OPTIONS pad and turn the dial to *CLOCK*. Press the dial to enter.
2. Turn the dial to set hours. Press the dial to enter.
3. Turn the dial to set minutes. Press the dial to enter.
4. Turn the dial to select AM or PM. Press the dial to enter.

Clock Display ON/OFF:

Use this feature to turn your clock display on or off. Press the OPTIONS pad, turn the dial to select *CLOCK DISPLAY ON/OFF*. Turn the dial to select *ON* or *OFF*. Press the dial to enter.

Delay Start:

Delay Start allows you to set the oven to delay cooking up to 24 hours. Press the OPTIONS pad, turn the dial to select *DELAY START* and press the dial to enter. Follow the display directions to set the Delay Start time and feature you wish to delay.

Beeper Volume:

Use this feature to adjust the volume of the beeper. You can even turn it off. Press the OPTIONS pad, turn the dial to select *BEEPER VOLUME*, press the dial to enter, and follow the display directions.

Scroll Speed:

Is the message scroll too slow or too fast? Change it! Press the OPTIONS pad, turn the dial to select *DISPLAY SCROLL SPEED*, press the dial to enter, and follow the display directions.

Reminder:

Use this feature to set an alarm beep to sound at a specific time of day. Press the OPTIONS pad, turn the dial to *SET/CLEAR REMINDER* and press the dial to enter. Turn the dial to select the hour and press to enter. Turn the dial to select the minute and press to enter. Turn the dial to select AM or PM and press to enter.

To review the setting, turn the dial to *SET/CLEAR REMINDER* and press the dial to enter. Turn the dial to *REVIEW* and press to enter.

To cancel the setting, turn the dial to *SET/CLEAR REMINDER* and press the dial to enter. Turn the dial to *CLEAR* and press to enter.

Review

Use this feature to review the current cooking selections you have set.



Press the selector dial during speedcooking or microwave cooking.

Help

Use this feature to find out more about your oven and its features.

The display will show a description for the program you have chosen.



1. Press the HELP pad.
2. Turn the dial to select the feature name. Press the dial to enter.

Features found in the HELP function.

Adding Time	Defrost by Weight	Set Beeper Volume
Back	Delay Start	Set Clock
Bake	Express Cook	Set Display On/Off
Beverage Reheat	Favorite Recipes	Set Display Speed
Broil	Help	Set Reminder
Child Lockout	Hold Food Warm	Slow Cook
Clear/Off	Options	Soften/Melt
Cook	Power/Temp	Speed Cook
Cook by Time	Proof Bread	Start/Pause
Cook/Heat by Food	Reheat	Time Cook 1 & 2
Custom Speed Cook	Repeat Last	Timer On/Off
Defrost	Resume	Toast
Defrost by Food Type	Review	Warm/Proof
Defrost by Time	Sensor Cooking	

Child lockout



You may lock the control panel to prevent the oven from being accidentally started or used by children.

Press and hold CLEAR/OFF for 5 seconds to lock and unlock.

When the control panel is locked, *Control is LOCKED* will be displayed briefly anytime a pad or dial is pressed.

Timer



Use this feature anytime you need a general purpose timer. It can even be used while cooking in the oven.

1. Press the TIMER pad.
2. Turn the dial to select the hours. Press the dial to enter.

3. Turn the dial to select the minutes. Press the dial to enter.

To cancel, press TIMER.

Automatic fan

An automatic fan protects the oven from too much heat inside the oven cavity.

It automatically turns on at low speed if it senses too much heat.

The fan will automatically turn off when the internal parts are cool. It may stay on for 30 minutes or more after the oven control is turned off.

Helpful hints

An occasional thorough wiping with a solution of baking soda and water keeps the inside fresh.

Be certain the oven control is turned off before cleaning any part of this oven.



How to clean the inside

Clean the inside of the oven often for proper heating performance.

Some spatters can be removed with a paper towel, others may require a warm soapy cloth. Remove greasy spatters with a sudsy cloth, then rinse with a damp cloth.

Do not use abrasive cleaners or sharp utensils on oven walls.

Never use a commercial oven cleaner on any part of your oven.

Do not clean the inside of the oven with metal scouring pads. Pieces can break off the pad, causing electrical shock.

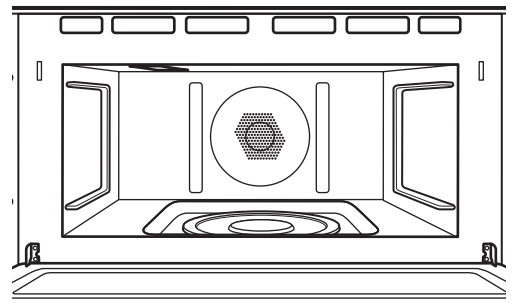

Walls, Floor, Inside Window, Metal and Plastic Parts on the Door

Removable turntable

The area underneath the turntable should be cleaned frequently to avoid odors and smoking during a cooking cycle.

The turntable can be broken if dropped. Wash carefully in warm, sudsy water. Dry completely and replace.

To replace the turntable, place its center over the spindle in the center of the oven and turn it until it seats into place. (Make sure the smooth side of the turntable is facing up and that its center seats securely on the spindle.)

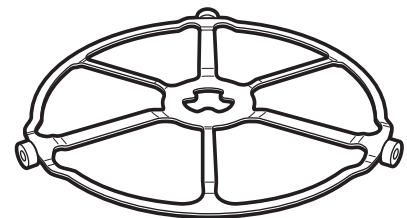

Turntable

Do not use the oven without the turntable in place.

Cooking trays and baking sheet

To prevent breakage, allow the trays to cool completely before cleaning. Wash carefully in warm, sudsy water or in the dishwasher.

Do not use metal scouring pads or abrasives, as they may damage the finish. A soap-filled scouring pad may be used to clean the trays.

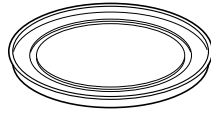

Clear glass tray for microwaving

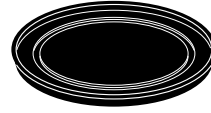

Nonstick metal tray for speedcooking

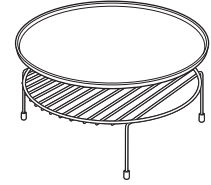

Put food directly on the aluminum baking sheet on the wire oven rack, and place them on the nonstick metal tray, when baking on two levels, broiling or toasting foods.

How to clean the outside

We recommend against using cleaners with ammonia or alcohol, as they can damage the appearance of the oven. If you choose to use a common household cleaner, first apply the cleaner directly to a clean cloth, then wipe the soiled area.

Case

Clean the outside with a sudsy cloth. Rinse and then dry. Wipe the window clean with a damp cloth.

Glass Control Panel and Door (on some models)

Wipe with a clean damp sponge. Dry thoroughly. Do not use cleaning sprays, large amounts of soap and water, abrasives or sharp objects on the panel—they can damage it.

Door Seal

It's important to keep the area clean where the door seals against the oven. Use only mild, non-abrasive detergents applied with a clean sponge or soft cloth. Rinse well.

Stainless steel (on some models)

Do not use a steel-wool pad; it will scratch the surface.

To clean the stainless steel surface, use warm, sudsy water or a stainless steel cleaner or polish. Always wipe the surface in the direction of the grain. Follow the cleaner instructions for cleaning the stainless steel surface.

To inquire about purchasing stainless steel appliance cleaner or polish, or to find the location of a dealer nearest you, please call our toll-free number, 800.626.2002 or visit ge.com.

Questions?
Use this
problem
solver

Problem	Possible Causes	What To Do/Explanation
LIGHTS		
Light during a speedcook cycle dims and cycles on and off, even at full power levels	This is normal. Power level has been automatically reduced because the oven is hot.	<ul style="list-style-type: none"> This is normal. The oven senses the heat level and adjusts automatically.
Light visible around the door and outer case while speedcooking	This is normal.	<ul style="list-style-type: none"> When the oven is on, light may be visible around the door and outer case.
FAN		
Fan continues to run after cooking stops	The oven is cooling.	<ul style="list-style-type: none"> The fan will automatically shut off when the internal parts of the oven have cooled.
Oven vent emits warm air while oven is on	This is normal.	
Fan comes on automatically when using the microwave	This is normal.	
COOKING		
The oven makes unusual sounds while cooking	Clicks and fans blowing are normal. The relay board is turning the components on and off.	<ul style="list-style-type: none"> These sounds are normal.
Smoke comes out of the oven when I open the door	Food is high in fat content. Aerosol spray used on the pans.	<ul style="list-style-type: none"> Smoke is normal when cooking high-fat foods.
Food is not fully cooked or browned at the end of a program	Programmed times may not match the size or amount of food you are cooking.	<ul style="list-style-type: none"> Increase or decrease time for doneness or adjust the upper or lower lamps for browning and cooking doneness.
SENSOR ERROR displayed along with an oven signal	Food amount or type placed in the oven does not match the program that was set.	<ul style="list-style-type: none"> Press the CLEAR/OFF pad. Set the oven program to match the food or liquid to be cooked or heated.
	Steam was not sensed by the oven because plastic wrap was not vented, a lid too tight was on the dish or a liquid was covered.	<ul style="list-style-type: none"> Vent plastic wrap, use a looser lid or uncover liquids when cooking or heating.

Questions?
Use this
problem
solver

Problem	Possible Causes	What To Do/Explanation
DISPLAY		
The display is blank	The clock display has been turned off.	<ul style="list-style-type: none"> • Check the OPTIONS menu for clock display settings. Turn the display on.
"Control is LOCKED" appears in display	The control has been locked.	<ul style="list-style-type: none"> • Press and hold CLEAR/OFF for 5 seconds to unlock the control.
Control display is lighted yet oven will not start	Clock is not set.	<ul style="list-style-type: none"> • Set the clock.
	Door not securely closed.	<ul style="list-style-type: none"> • Open the door and close securely.
	START/PAUSE pad not pressed after entering cooking selection.	<ul style="list-style-type: none"> • Press START/PAUSE.
	Another selection already entered in oven and CLEAR/OFF pad not pressed to cancel it.	<ul style="list-style-type: none"> • Press CLEAR/OFF.
	Size, quantity or cooking time not entered after final selection.	<ul style="list-style-type: none"> • Make sure you have entered cooking time after selecting.
	CLEAR/OFF was pressed accidentally.	<ul style="list-style-type: none"> • Reset cooking program and press START/PAUSE.
OTHER PROBLEMS		
The door and inside of the oven feels hot	The heat lamps produce intense heat in a small space.	<ul style="list-style-type: none"> • This is normal. • Use oven mitts to remove food when ready.
Oven will not start	A fuse in your home may be blown or the circuit breaker tripped.	<ul style="list-style-type: none"> • Replace fuse or reset circuit breaker.
	The door is not closed.	<ul style="list-style-type: none"> • Open and close the door securely.

With the purchase of your new Monogram appliance, receive the assurance that if you ever need information or assistance from GE, we'll be there. All you have to do is call—toll-free!

GE Answer Center®

**In the USA:
800.626.2000**

Whatever your question about any Monogram major appliance, GE Answer Center® information service is available to help. Your call—and your question—will be answered promptly and courteously. Call the GE Answer Center® Monday to Friday, 8 a.m. to 10 p.m. EST, and Saturday, 8 a.m. to 7 p.m. EST.

OR

Visit our Website at: monogram.com

In Canada, call 800.561.3344.

Repair Service

**In the USA:
800.444.1845**

**In Canada:
800.561.3344**

A GE consumer service professional will provide expert repair service, scheduled at a time that's convenient for you. To schedule service, call Monday to Friday, 7 a.m. to 10 p.m. EST, or Saturday and Sunday, 8 a.m. to 6 p.m. EST. Many GE Consumer Service company-operated locations offer you service today or tomorrow, or at your convenience. Our factory-trained technicians know your appliance inside and out—so most repairs can be handled in just one visit.

In Canada: Monday to Friday, 7 a.m. to 8 p.m. and Saturday, 8 a.m. to 5 p.m. EDT.

For Customers With Special Needs...

**In the USA:
800.626.2000**

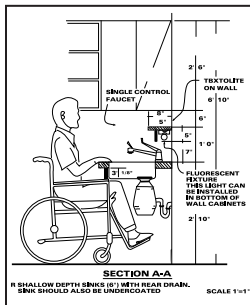

GE offers, free of charge, a brochure to assist in planning a barrier-free kitchen for persons with limited mobility.

Consumers with impaired hearing or speech who have access to a TDD or a conventional teletypewriter may call 800.TDD.GEAC (800.833.4322) to request information or service.

Service Contracts

**In the USA:
800.626.2224**

**In Canada:
800.561.3344**

You can have the secure feeling that GE Consumer Service will still be there after your warranty expires. Purchase a GE contract while your warranty is still in effect and you'll receive a substantial discount. With a multiple-year contract, you're assured of future service at today's prices.

Parts and Accessories

**In the USA:
800.626.2002**

**In Canada:
800.561.3344**

Individuals qualified to service their own appliances can have parts or accessories sent directly to their home. The GE parts system provides access to over 47,000 parts...and all GE Genuine Renewal Parts are fully warranted. VISA, MasterCard and Discover cards are accepted.

User maintenance instructions contained in this manual cover procedures intended to be performed by any user. Other servicing generally should be referred to qualified service personnel. Caution must be exercised, since improper servicing may cause unsafe operation.

YOUR MONOGRAM ADVANTIUM OVEN WARRANTY

Staple sales slip or cancelled check here. Proof of original purchase date is needed to obtain service under warranty.

WHAT IS COVERED

From the Date of the Original Purchase

LIMITED ONE-YEAR WARRANTY

For one year from the date of the original purchase, GE will replace *any part of the microwave oven* which fails due to a defect in materials or workmanship. During this limited one-year warranty, GE will also provide, free of charge, all labor and related service to replace the defective part.

FIVE-YEAR LIMITED WARRANTY

For five years from the date of the original purchase, GE will replace the *magnetron tube*, if the magnetron tube fails due to a defect in materials or workmanship. During this five-year limited warranty, you will be responsible for any labor or in-home service costs.

.....
All warranty service will be provided by our Factory Service Centers or by our authorized Customer Care® servicers during normal working hours.

Should your appliance need service, during warranty period or beyond, in the U.S.A call 800.444.1845.

Please have serial and model numbers available when calling for service.

WHAT IS NOT COVERED

- Service trips to your home to teach you how to use the product.
- Improper installation, delivery or maintenance.
- Product not accessible to provide required service.
- Failure of the product or damage to the product if it is abused, misused (for example, cavity arcing from wire rack or metal/foil), or used for other than the intended purpose or used commercially.
- Replacement of house fuses or resetting of circuit breakers.
- Damage to the product caused by accident, fire, floods or acts of God.
- Incidental or consequential damage caused by possible defects with this appliance.
- Damage caused after delivery.

EXCLUSION OF IMPLIED WARRANTIES—Your sole and exclusive remedy is product repair as provided in this Limited Warranty. Any implied warranties, including the implied warranties of merchantability or fitness for a particular purpose, are limited to one year or the shortest period allowed by law.

This warranty is extended to the original purchaser and any succeeding owner for products purchased for home use within the USA. If the product is located in an area where service by a GE Authorized Servicer is not available, you may be responsible for a trip charge or you may be required to bring the product to an Authorized GE Service Location for service. In Alaska, the warranty excludes the service calls to your home.

Some states do not allow the exclusion or limitation of incidental or consequential damages, so the above limitation or exclusion may not apply to you. This warranty gives you specific legal rights, and you may also have other rights which vary from state to state. To know what your legal rights are in your state, consult your local or state consumer affairs office or your state's Attorney General.

Warrantor: General Electric Company, Louisville, KY 40225



GE Consumer & Industrial Appliances
General Electric Company
Louisville, KY 40225
ge.com