

quick start guide

RFG237AA
RFG238AA

Product features



Surround Multi Flow

A center-positioned fan and ducts with multiple flow effluences provide uniform cooling for each shelf and fresh food compartment corners.



Ice and Water Dispenser

The dispenser provides ice and cold water at any time.



Twin Cooling System

The refrigerator and the freezer have two evaporators. Given this independent system, the freezer and the refrigerator are cooled individually and more efficiently. Food odor from the refrigerator does not affect food in the freezer due to separate air flow circulation.



Secure Auto Close Door System

- Secure Auto Close Door System
- Cool tight doors
- Energy saving
- Prevents condensation on fridge doors



Electronic control from outside of Pantry Cover

The Cool Select Pantry is a full width drawer with an adjustable temperature control to help keep food fresh longer.



Easy Handle System

- Ez-open Freezer Door
- Ergonomic Door Design



Super Extended Drawer

The upper drawer in the freezer comes out automatically when you open the freezer door and can be pulled out all the way to the Tilting Pocket.

The Installation Space

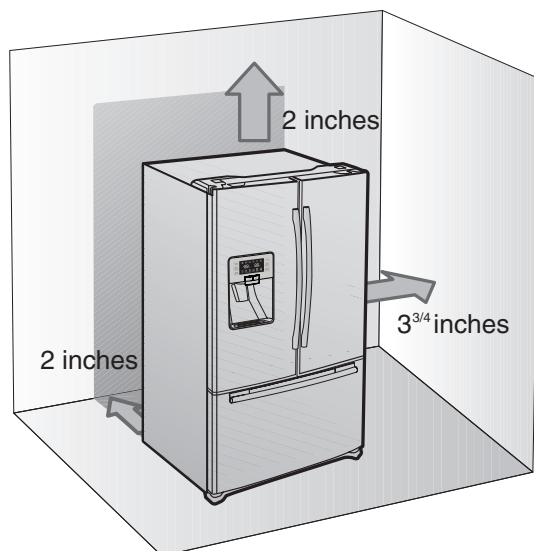

Selecting the best location for the Refrigerator

- A location with easy access to the water supply.
- A location without direct exposure to sunlight.
- A location with level (or nearly level) flooring.
- A location with enough space for the Refrigerator doors to open easily.
- Allow sufficient space for air circulation of the internal cooling system.

If the Refrigerator does not have enough space, the internal cooling system may not work properly.

If your refrigerator has an ice maker, allow extra space at the back for the water line connections. When you install the refrigerator next to a fixed wall, minimum clearance is 3 3/4" (95mm) between the refrigerator and wall to allow the door to swing open.

First thing! Make sure that you can easily move your Refrigerator to its final location by measuring doorways (both width and height), thresholds, ceilings, stairways, etc.

The following chart details the exact height and depth of Samsung French Door Refrigerator.

Model	Depth "A"	Width "B"	Height "C"	Overall Height "D"	Depth "E"
RFG238AA	33" (71.2cm)	35.75" (90.8cm)	68.66" (176.9cm)	69.72" (177.4cm)	35.63" (77.4cm)

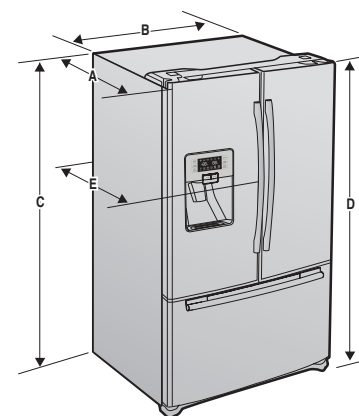

- Allow clearance to the right, left, back and top when installing. This will help reduce power consumption and keep your energy bills lower.
- Do not install the Refrigerator where the temperature will go below 50°F (10°C).
- Do not locate the refrigerator where it may become wet.



FLOORING

For proper installation, this refrigerator must be placed on a level surface of hard material that is the same height as the rest of the flooring. This surface should be strong enough to support a fully loaded refrigerator, or approximately 313lbs (142kg). To protect the finish of the flooring, cut a large section of the cardboard carton and place under the refrigerator where you are working. When moving a refrigerator, it is needed to pull and push in the back-and-forth direction.

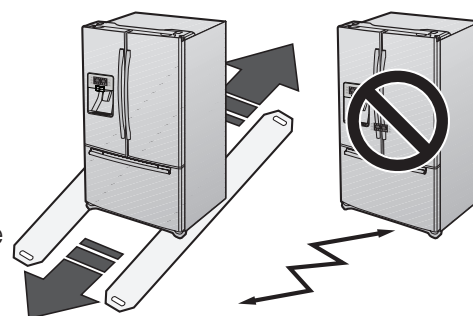

Operating your French Door Refrigerator

(RFG237 MODEL)

USING THE CONTROL PANEL

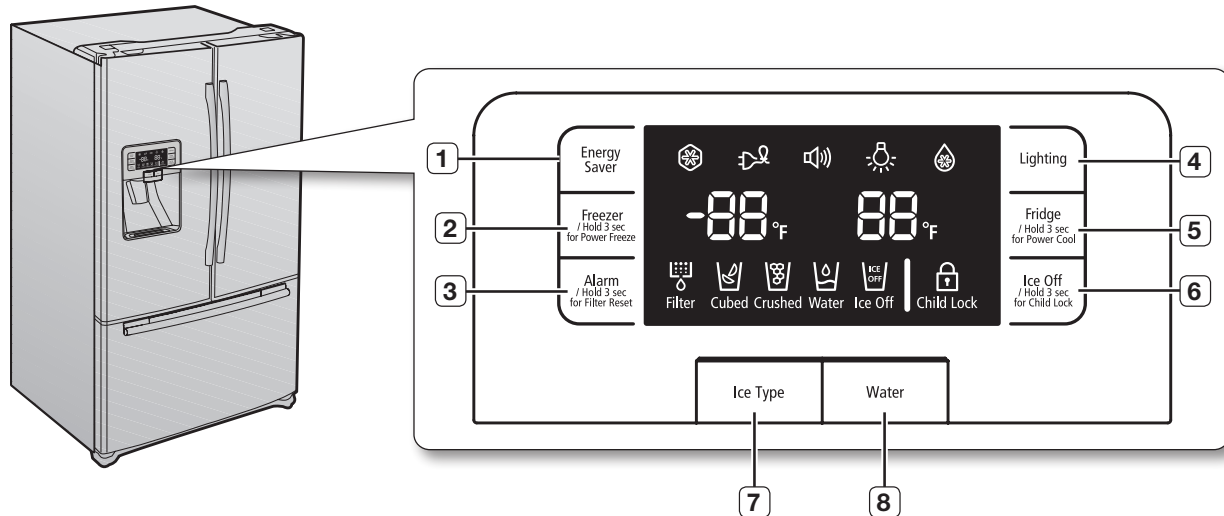

(1) Energy Saver	Press the Energy Saver button for better energy efficiency. If water drops appear on the doors, turn the Energy Saver function off.
(2) Freezer/hold 3 sec for Power Freezer	Press the Freezer / hold 3 sec for Power Freezer button to set the Freezer to your desired temperature. You can set the temperature between -8°F and 8°F. Press and hold the Freezer/hold 3 sec for Power freezer button for 3 seconds to speed up the cooling in the freezer. It can be helpful if you need to quickly freeze easily spoiled items or if the temperature in the freezer has warmed up dramatically (For example, if the door was left open).
(3) Alarm / hold 3 sec for Filter Reset	Press the Alarm / hold 3 sec for Power Freezer button to turn off the door open alarm. (Initially, alarm mode is On) After removing the old water filter and installing a new one, reset the indicator by pressing and holding this button for 3 seconds. (The indicator is lit initially and will light again in about 6 months to let you know it is time to change yo ur water filter.)
(4) Lighting	Press the Lighting button to turn on the Dispenser LED lamp.
(5) Fridge / hold 3 sec for Power Cool	Press the Fridge / hold 3 sec for Power Cool button to set the fridge to your desired temperature. You can set the temperature between 34°F and 46°F. Press and hold the Fridge / hold 3 sec for Power Cool button for 3 seconds to speed up the cooling in the refrigerator. It can be helpful if you need to quickly cool easily-spoiled items or if the temperature in the fridge has been warmed up dramatically (For example, if the door was left open).
(6) Ice off / Hold 3 sec for Child Lock	Press the Ice OFF / hold 3 sec for Child Lock button to turn the fridge or freezer ice making function off. If you press and hold this button for 3 seconds, the display and dispenser will be locked.
(7) Ice Type	Press the Ice Type button to select your desired ice type. Cubed and crushed ice modes will be alternatively changed whenever you press the button. This mode can not be used with the Water mode simultaneously.
(8) Water	Press the Water button to dispense water. This mode can not be used with the Ice Type mode simultaneously. Water mode will be off if you press the Ice Type button.

 Some functions are activated after a few-second delay when the buttons are pressed, while others operate immediately. This is normal operation.

Operating your French Door Refrigerator

(RFG237 MODEL)

USING THE DIGITAL DISPLAY

Freezer Temp (1) indicates the current freezer temperature.

Fridge Temp (2) indicates the current refrigerator temperature.

If you do not press any button, freezer & fridge temperature indicator will turn off in a few seconds. If any button is pressed, the display will light up again.

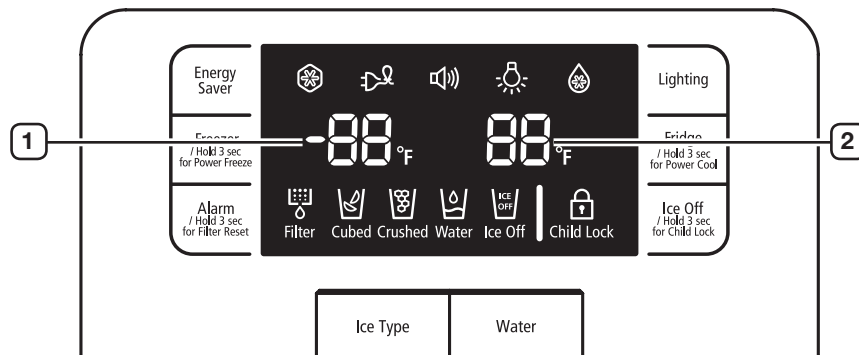

Power Freeze

This icon will light up when you press the **Freezer / Hold 3 sec for Power Freeze** button for 3 seconds. **Power Freeze** is great when you need a lot of ice. When you have enough ice, just press the same button again for 3 seconds to cancel the **Power Freeze** mode. After 2 and a half hours, **Power Freeze** mode will turn off automatically to decrease energy consumption.

Cubed Ice , Crushed Ice , Water

Enjoy cubed or crushed ice by selecting your preference from the digital control panel. If you don't need ice, turn the function off to save on water and energy consumption. Each Ice type icon will light up on by your selection.

Power Cool

This icon will light up when you press the **Fridge / Hold 3 sec for Power Cool** button for 3 seconds. For a quick fridge cool down, use **Power Cool** mode. If you want to cancel the **Power Cool** mode, just press the same button again for 3 seconds. After 2 and a half hours, **Power cool** mode will turn off automatically to decrease energy consumption.

Filter

When the filter indicator light is on, it is time to change the filter. Typically this happens about every 6 months. The filter indicator will be Blue when you initially insert the water filter.

The filter indicator will be Light Pink when you have used your water filter for 270 gallons.

The filter indicator will be Red when you have used your water filter for 300 gallons.

After removing the old water filter and installing a new one (see page 40 of the owner's manual for instructions) when the filter indicator is red, reset the indicator by pressing and holding the "Alarm/Hold 3 sec for Filter Reset" button for 3 seconds. (The filter indicator will be blue or yellow green when the indicator is reset.)

Cooling Off mode ("OF & OF" code on the display)

Cooling Off Mode stops cooling in the freezer and refrigerator compartments, but does not shut off electrical power to the refrigerator. To use this feature, press Energy Saver Button and Freezer/ hold 3 sec for Power Freeze Button simultaneously for 3 seconds until an alarm sound is heard. To cancel this mode, press the same buttons again for 3 seconds and the refrigerator will return to cooling mode.

 This function is for store display refrigerators. It is not for customer use.

Energy saver

This icon will light up when you press the **Energy Saver** button. The Energy Saver function is automatically set to “ON” when power is supplied to the Refrigerator. If condensation occurs on the doors, turn the Energy Saver mode off.

Lighting

This icon will light up when you press the **Lighting** button. In this case, the dispenser light (under the display) will be on constantly. If you would like the dispenser light to come on only when using the dispenser, turn the Lighting mode off.

Alarm

This icon will light up when you press the **Alarm** button. The door alarm will sound if any door is open for more than 3 minutes. The beeping stops when you close the door. Initially the Alarm is set to on.

Ice off

This icon will light up when you press the “Ice Off” button. In this case, the ice will not be produced.

Lock

This icon will light up when you press the **Lock** button. In this case, you won't be able to use the control panel. If you press and hold the Ice Off/Hold button for 3 sec to unlock Child Lock, you will be able to use the control panel again.

CONTROLLING THE TEMPERATURE

Basic temperature of Freezer and Refrigerator Compartments

The basic temperature and/or recommended temperatures of the Freezer and Refrigerator Compartments are -2°F and 38°F respectively. If the temperature of Freezer and Refrigerator Compartments are too high or low, adjust the temperature manually.

Controlling the Freezer temperature

The Freezer temperature can be set between 8°F and -8°F to suit your particular needs. Press the Freezer button repeatedly until the desired temperature is shown in the temperature display. The temperature will move 2°F degrees with each press (-2°F → -4°F → -6°F → -8°F → 8°F → 6°F → 4°F → 2°F → 0°F → -2°F). Keep in mind that foods like ice cream may melt at 4°F. The temperature display will move sequentially from -8°F to 8°F. Five seconds after the new temperature is set, the display will show the actual current freezer temperature until the new temperature is reached.

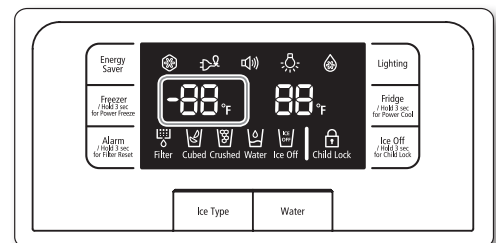

Using the Power Freeze

If you need a lot of ice or if you want to cool down the freezer faster, you can use the **Power Freeze** function. Press and hold the **Freezer/ Hold 3 sec for Power Freeze** button for 3 seconds. Then, the power freeze indicator will light and activate the power freeze mode independent of the freezer set temperature. If you select **Power freeze**, the inside temperature of the freezer will decrease for about two and a half hours. When you have enough ice, just press and hold the button for 3 seconds again to cancel the **Power Freeze** mode. Then, the indicator will go out and the freezer will return to the set temperature again.

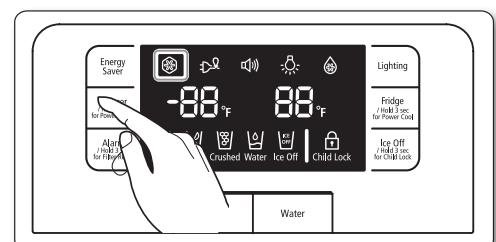

Operating your French Door Refrigerator

(RFG238 MODEL)

USING THE CONTROL PANEL

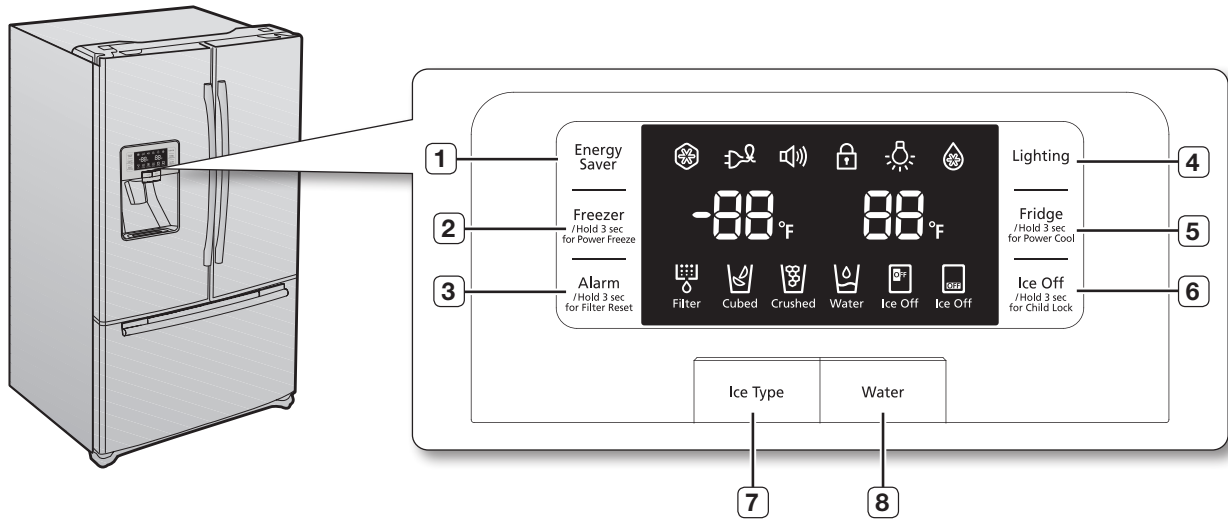

- (1) Energy Saver** Press the **Energy Saver** button for better energy efficiency. If water drops appear on the doors, turn the **Energy Saver** function off.
- (2) Freezer/hold 3 sec for Power Freeze** Press the **Freezer / hold 3 sec for Power Freeze** button to set the Freezer to your desired temperature. You can set the temperature between -8°F and 8°F. Press and hold the **Freezer/hold 3 sec for Power freezer** button for 3 seconds to speed up the time needed to freeze products in the Freezer. It can be helpful if you need to quickly freeze easily spoiled items or if the temperature in the Freezer has warmed dramatically (For example, if the door was left open).
- (3) Alarm / hold 3 sec for Filter Reset** Press the **Alarm / hold 3 sec for Power Freeze** button to turn off the door open alarm. (At first, alarm mode is On) After removing the old water filter and installing a new one, reset the indicator by pressing and holding this button for 3 seconds. (The indicator is lit at first and will light again in about 6 months to let you know it is time to change your water filter.)
- (4) Lighting** Press the **Lighting** button to turn on the Dispenser LED lamp.
- (5) Fridge / hold 3 sec for Power Cool** Press the **Fridge / hold 3 sec for Power Cool** button to set the fridge to your desired temperature. You can set the temperature between 34°F and 46°F. Press and hold the **Fridge / hold 3 sec for Power Cool** button for 3 seconds to speed up the time needed to cool products in the Refrigerator. It can be helpful if you need to quickly cool easily spoiled items or if the temperature in the fridge has warmed dramatically (For example, if the door was left open).
- (6) Ice off / Hold 3 sec for Child Lock** Press the **Ice OFF / hold 3 sec for Child Lock** button to turn the fridge or freezer ice making function off. If you press and hold this button for 3 seconds, the display and dispenser will be locked.
- (7) Ice Type** Press the **Ice Type** button to select your desired ice type. Cubed and crushed ice modes will be alternatively changed whenever you press the button. This mode can not be used with the Water mode simultaneously.
- (8) Water** Press the **Water** button to dispense water. This mode can not be used with the Ice Type mode simultaneously. Water mode will be off if you press the Ice Type button.

 Some functions are activated after a few-second delay when the buttons are pressed, while others operate immediately. This is normal operation.

Operating your French Door Refrigerator

(RFG238 MODEL)

USING THE DIGITAL DISPLAY

Freezer Temp (1) indicates the current freezer temperature.

Fridge Temp (2) indicates the current refrigerator temperature.

If you do not press any button, freezer & fridge temperature indicator will turned off in a few seconds. If any button is pressed, the display will light up again.

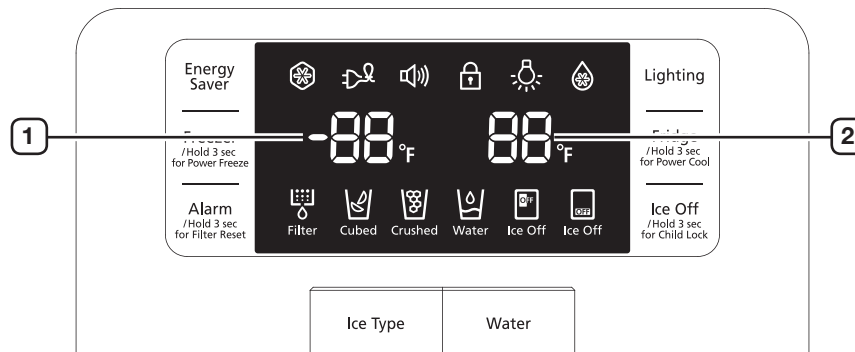

Power Freeze

This icon will light up when you press the **Freezer / Hold 3 sec for Power Freeze** button for 3 seconds. **Power Freeze** is great when you need a lot of ice. When you have enough ice, just press the same button again for 3 seconds to cancel the **Power Freeze** mode. After 2 and a half hours, **Power Freeze** mode will turn off automatically to decrease energy consumption.

Cubed Ice , Crushed Ice , Water

Enjoy cubed or crushed ice by selecting your preference from the digital control panel. If you don't need ice, turn the function off to save on water and energy consumption. Each Ice type icon will light up depending on what is currently chosen.

Power Cool

This icon will light up when you press the **Fridge / Hold 3 sec for Power Cool** button for 3 seconds. For a quick fridge cool down, use **Power Cool** mode. If you want to cancel the **Power Cool** mode, just press the same button again for 3 seconds. After 2 and a half hours, **Power cool** mode will turn off automatically to decrease energy consumption.

Filter

When the filter indicator light is on, it is time to change the filter. Typically this happens about every 6 months. The filter indicator will be Blue when you initially insert the water filter.

The filter indicator will be Light Pink when you have used your water filter for 270 gallons.

The filter indicator will be Red when you have used your water filter for 300 gallons.

After removing the old water filter and installing a new one (see page 40 of the owner's manual for instructions) when the filter indicator is red, reset the indicator by pressing and holding the "Alarm/ Hold 3 sec for Filter Reset" button for 3 seconds. (The filter indicator will be blue or yellow green when the indicator is reset.)

Cooling Off mode ("OF & OF" code on the display)

Cooling Off Mode stops cooling in the freezer and refrigerator compartments, but does not shut off electrical power to the refrigerator. To use this feature, press Energy Saver Button and Freezer/ hold 3 sec for Power Freeze Button simultaneously for 3 seconds until an alarm sound is heard. To cancel this mode, press the same buttons again for 3 seconds and the refrigerator will return to cooling mode.

 This function is for store display refrigerators. It is not for customer use.

Energy saver

This icon will light up when you press the **Energy Saver** button. The Energy Saver function is automatically set to “ON” when power is supplied to the Refrigerator. If condensation occurs on the doors, turn the Energy Saver mode off.

Lighting

This icon will light up when you press the **Lighting** button. In this case, the dispenser light (under the display) will be on constantly. If you would like the dispenser light to come on only when using the dispenser, turn the Lighting mode off.

Alarm

This icon will light up when you press the **Alarm** button. The door alarm will sound if any door is open for more than 3 minutes. The beeping stops when you close the door. Initially the Alarm is set to on.

Fridge Ice off

This icon will light up when you press the **Fridge Ice Off** button. In this case, the fridge ice will not be produced.

Freezer Ice off

This icon will light up when you press the **Freezer Ice Off** button. In this case, the freezer ice will not be produced.

- As this refrigerator has a dual Ice Maker, there is a possibility of using more energy. We recommend if you have enough ice, set **Ice Off** to save energy.
- You may occasionally hear noises from ice dropping or water flowing to the icemaker. These noises are part of normal operation.

Lock

This icon will light up when you press the **Lock** button. In this case, you won't be able to use the control panel. If you press and hold the Ice Off/Hold button for 3 sec to unlock Child Lock, you will be able to use the control panel again.

CONTROLLING THE TEMPERATURE

Basic temperature of Freezer and Refrigerator Compartments

The basic temperature and/or recommended temperatures of the Freezer and Refrigerator Compartments are -2°F and 38°F respectively.

If the temperature of Freezer and Refrigerator Compartments are too high or low, adjust the temperature manually.

Controlling the Freezer temperature

The Freezer temperature can be set between 8°F and -8°F to suit your particular needs. Press the Freezer button repeatedly until the desired temperature is shown in the temperature display. The temperature will move 2°F degrees with each press (-2°F → -4°F → -6°F → -8°F → 8°F → 6°F → 4°F → 2°F → 0°F → -2°F). Keep in mind that foods like ice cream may melt at 4°F. The temperature display will move sequentially from -8°F to 8°F. Five seconds after the new temperature is set, the display will show the actual current freezer temperature until the new temperature is reached.

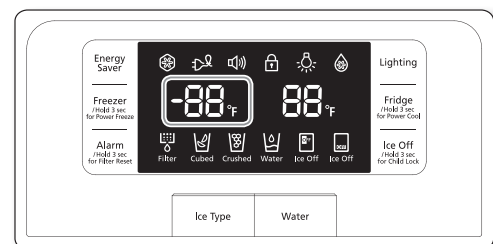

Using the Power Freeze

If you need a lot of ice or if you want to cool down the freezer faster, you can use the **Power Freeze** function. Press and hold the **Freezer/ Hold 3 sec for Power Freeze** button for 3 seconds. Then, the power freeze indicator will light and activate the power freeze mode independent of the freezer set temperature. If you select **Power freeze**, the inside temperature of the freezer will decrease for about two and a half hours. When you have enough ice, just press and hold the button for 3 seconds again to cancel the **Power Freeze** mode. Then, the indicator will go out and the freezer will return to the set temperature again.

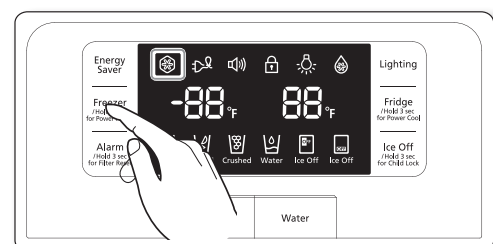

Names and basic functions

NAME OF EACH COMPONENT

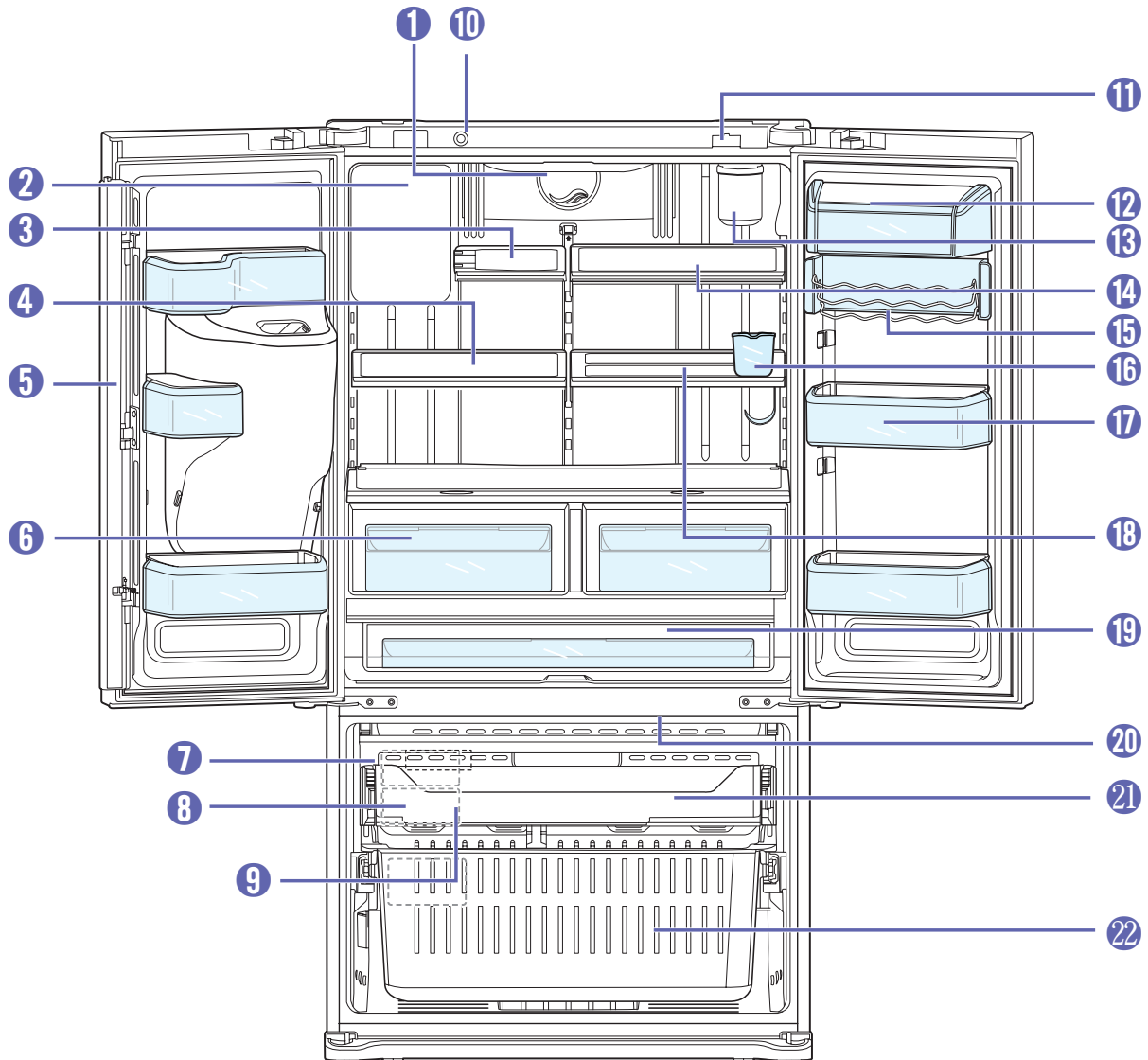

1. Light	9. Tilting Pocket	17. Door Bins
2. Ice Maker	10. Interlocking switch	18. Quick-Space Glass Shelf
3. Foldable-Shelf	11. Door Closer	19. Cool Select Pantry™
4. Slide-Shelf	12. Dairy Compartment	20. Light
5. Vertical Hinged Section	13. Water Filter	21. Auto Pull Out Drawer
6. Vegetable & Fruit Drawers	14. Tempered glass shelves	22. Freezer Drawer Bin
7. Freezer Ice-Maker	15. Can Rack	
8. Ice Bucket	16. Egg Container	

Troubleshooting

PROBLEM	SOLUTION
The Refrigerator does not work at all or it does not chill sufficiently.	<ul style="list-style-type: none"> • Check that the power plug is properly connected. • Is the temperature control on the display panel set to the correct temperature? Try setting it to a lower temperature. • Is the Refrigerator in direct sunlight or located near a heat source? • Is the back of the Refrigerator too close to the wall and therefore keeping air from circulation?
The food in the Refrigerator is frozen.	<ul style="list-style-type: none"> • Is the temperature control on the display set to the correct temperature? Try setting it to a warmer temperature. • Is the temperature in the room too low? • Did you store the food with high water content in the coldest part of the Refrigerator? Try moving those items into the body of the Refrigerator instead of keeping them in the Cool Select Pantry™.
You hear unusual noise or sounds.	<ul style="list-style-type: none"> • Check that the Refrigerator is level and stable. • Is the back of the Refrigerator too close to the wall and therefore keeping air from circulating? • Was anything dropped behind or under the Refrigerator? • A “ticking” sound is heard from inside the Refrigerator. It is normal and occurs because various accessories are contracting or expanding according to the temperature of the Refrigerator interior.
The front corners and vertical hinged section of the appliance are hot and condensation is occurring.	<ul style="list-style-type: none"> • Some heat is normal as anti-condensators are installed in the vertical hinged section of the Refrigerator to prevent condensation. • Is the Refrigerator door ajar? Condensation can occur when you leave the door open for a long time.
Ice Maker is not producing ice.	<ul style="list-style-type: none"> • Did you wait for 12 hours after installation of the water supply line before making ice? • Is the water line connected and the shut-off valve opened? • Did you manually stop the ice making function? • Is the Freezer temperature too warm? Try setting the Freezer temperature lower.
You can hear water bubbling in the Refrigerator.	<ul style="list-style-type: none"> • This is normal. The bubbling comes from the Refrigerator coolant liquid circulating through the Refrigerator.
There is a bad smell in the Refrigerator.	<ul style="list-style-type: none"> • Check for spoiled food. • Foods with strong odors(for example, fish) should be tightly covered. • Clean out your Freezer periodically and throw away any spoiled or suspicious food.
Frost forms on the walls of the Freezer.	<ul style="list-style-type: none"> • Is the air vent blocked? Remove any obstructions so air can circulate freely. • Allow sufficient space between the foods stored for efficient air circulation. • Is the Freezer drawer closed properly?
Water dispenser is not functioning.	<ul style="list-style-type: none"> • Is the water line connected and the shut-off valve opened? • Has the water supply line tubing been crushed or kinked? Make sure the tubing is free and clear of any obstruction. • Is the water tank frozen because the Refrigerator temperature is too low? Try selecting a warmer setting on the main display panel.
Auto close system does not work with the freezer door.	<ul style="list-style-type: none"> • Is there an imbalance between the right and left parts of the door? • Close and open the door smoothly 1~2 times. Then, the auto close system will be worked well again. • Try opening the door smoothly to avoid the unbalance between the right part and the left part of the door.