

FRIGIDAIRE

affinity



Front Load Washers

FAFW3517K W/B

3.5 Cu. Ft. Electric



Powerful Performance

- 7 Cycles Including -
 - Quick Cycle (Fast 25-minute wash cycle)
 - Whitest Whites
- 17 Options Including -
 - Stain Clean
- 5 Temperature Selections Including -
 - Automatic Temperature Control
- Internal Water Heater (1000W)
- Automatic Water Level Adjustments
- 5 Spin Speeds
- 3 Soil Levels

Performance-Driven Style

- Express-Select™ Controls
- TimeWise™ Technology
- Stainless Steel Tub

More Easy-To-Use Features

- Estimated Time Remaining
- 4 Status Indicators Including -
 - Add-A-Garment
- Delay Start - Up to 14 Hours
- SilentDesign™

SpaceWise™ Design

- Optional 15" Largest Capacity¹ Drawer Pedestals
 - Classic White - PN# APWD15W
 - Classic Black - PN# APWD15E

Signature Features

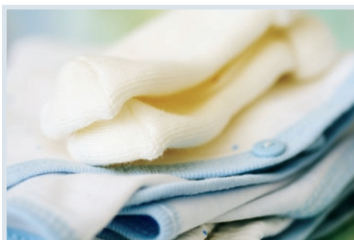

WashSense™ Technology

Our WashSense™ technology ensures clothes get clean with care.



Save Your Settings

Automatically saves your last wash setting so you can save time when doing laundry.

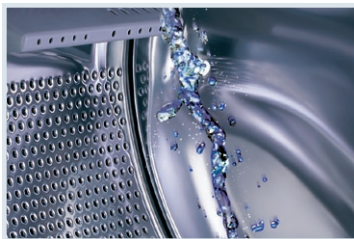

Advanced Rinse Technology

Final rinse uses fresh water to ensure whiter whites and reduce allergens.



Balance Control System

Vibration control technology keeps even oversized loads balanced for smooth, quiet operation. Ideal for use on second floors.

ENERGY STAR®
NSF® International
Certification



Capacities

Total Capacity 3.5 Cu Ft. (IEC)

Overall Exterior Dimensions

Height 36"
Width 27"
Depth² 28"

Available in:

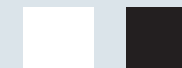

Classic
White
(W)

Classic
Black
(B)

¹Based on manufacturer specifications.

²29-3/4" when aligned with front of dryer unit.

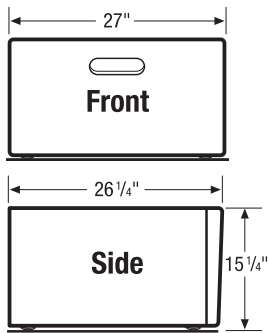
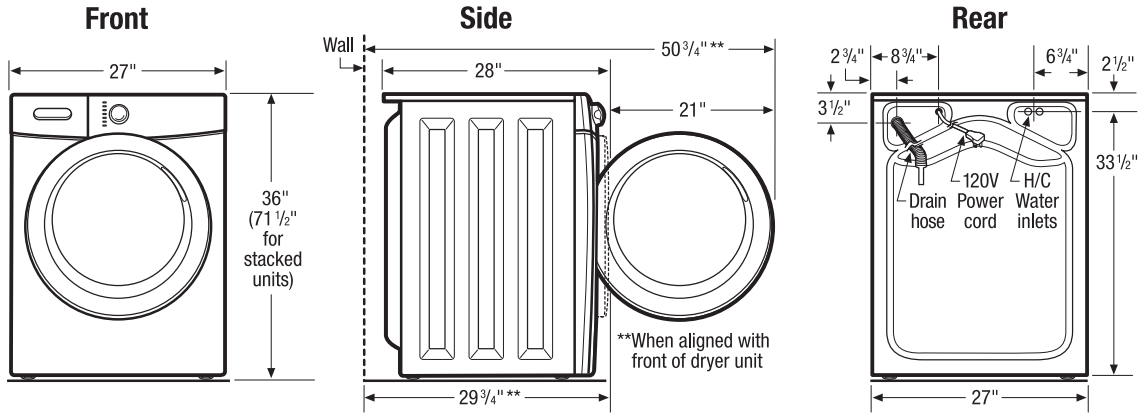

15" Drawer Pedestal Installation

Elevates washer height to 51 1/4". For detailed pedestal installation, refer to instructions included with pedestal or on web. **Note:** Pedestal Installation requires modified utility hookup locations. For details, refer to Product Installation Guide on web.

Built-In Installations

For built-in installations, NO minimum clearance required around sides or backs of units. For closet installation, allow additional 1" clearance between fronts of units and door. Location of plumbing, exhaust and utility hookups MUST be considered in built-in installations. For additional installation details, refer to Product Installation Guides on web.

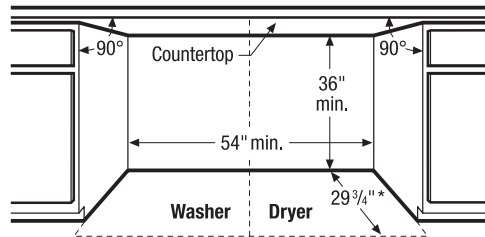

Side-by-Side Units in Under-Counter Installation

Can be installed with standard countertop and/or cabinetry.

* To achieve minimal installation depth dimensions, dryer MUST be vented straight back. For installation with quick-turn 90° elbow, refer to Product Installation Guide on web for approximate clearances incurred with multi-directional exhausting options in freestanding, pedestal-mounted, or stacked installation.

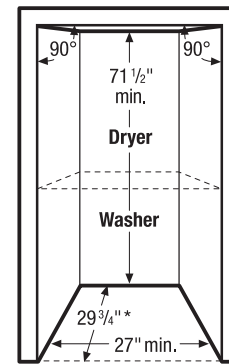

Stacked Units in Recessed or Closet Installation

For detailed stacked installation, refer to instructions included with Stacking Kit or on web. **Note:** Stacked installation requires modified utility hookup locations for dryer. For details, refer to Product Installation Guide on web.

Front Load Washer Specifications

- Product Shipping Weight (approx.) - 220 Lbs.
- An electrical supply with grounded three-prong receptacle is required. The power supply circuit must be installed in accordance with current edition of National Electrical Code (ANSI/NFPA 70) and local codes & ordinances. (Do not use same circuit as dryer.)
- Voltage Rating - 120V/60 Hz/15 Amps
- Amps @ 120 Volts = 8 Amps
- Equipped with 120V 3-wire power supply cord, approx. 60" long.
- Always consult local and national electric & plumbing codes.
- To maximize detergent effectiveness, ambient temperature should never be below 60° F.
- Can be installed alone, with or without optional 15" Drawer Pedestal, or stacked below matching Frigidaire® Affinity Dryer, which requires installation of optional Dryer Stacking Kit. (For installation details, refer to instructions included with optional pedestal or stacking kit or on web.)
- Can be built in with matching Frigidaire® Affinity Dryer in under-counter, recessed or closet installation. (Refer to Built-In Installations on this page for cutout dimensions. For additional installation details, refer to Product Installation Guide on web.)
- Closet installation requires vented door with 2 unobstructed louvered openings, minimum 60 sq. in. each, located 3" from top and bottom of door. Full-length 120 sq. in. opening also acceptable. Allow additional 1" clearance between fronts of units and closed door.
- Do NOT install in area exposed to dripping water or outdoor weather conditions, or where gasoline or other flammables, including automobiles, are kept or stored.

- Floor MUST be solid with 1" maximum slope. To minimize vibration or movement, reinforcement of floor may be necessary. Do NOT install on carpeted surface.
- Leveling legs supplied to level washer properly and reduce excessive noise and vibration.
- H/C water faucets MUST be installed within 43" of washer's water inlet and MUST be 3/4" to connect to 48-1/2" inlet hoses.
- Water pressure MUST be between 30 and 120 psi with NOT more than 10 psi pressure difference between hot and cold.
- Drain required with standpipe diameter of 1-1/4" min. and height of 24" min./96" max. above floor, capable of eliminating 17 gallons per minute. Attached 52" drain hose can reach 74"-high standpipe. For higher standpipe, optional Drain Hose Extension Kit available.

Note: For planning purposes only. Refer to Product Installation Guide on the web at frigidaire.com for detailed instructions.

Optional Accessories

- Dryer Stacking Kit - (PN# 134700600).
- 15" Classic White Drawer Pedestal - (PN# APWD15W).
- 15" Classic Black Drawer Pedestal - (PN# APWD15E).
- Mobile Home Installation Kit - (PN# 137067200).
- Drain Hose Extension Kit - (PN# 137098000).