

Owner's Manual

Advantium®
240V Speedcook Oven

For Models:
ZSC2200
ZSC2201
ZSC2202

49-40578-1
MFL39991102

01-08 JR

monogram.com



Introduction

Your new Monogram Advantium 240V Oven makes an eloquent statement of style, convenience and kitchen planning flexibility. Whether you chose it for its purity of design, assiduous attention to detail—or for both of these reasons—you'll find that your Monogram ovens's superior blend of form and function will delight you for years to come.

Your Monogram oven was designed to provide the flexibility to blend in with your kitchen cabinetry. Its sleek design can be beautifully integrated into the kitchen.

The information on the following pages will help you operate and maintain your oven properly.

If you have any questions, visit our Website at: monogram.com

Contents

Advantium

Cooking controls12
 Oven features11
 Safety4-9
 Getting to know the Advantium10

Speedcooking

Cooking tips14
 Custom speedcook17
 Favorite recipes18, 19
 Power level15
 Repeat last17
 Resume feature17
 Speedcook cookware14
 Speedcook-safe cookware7
 Things that are normal13
 Using the pre-set
 speedcook menu16

Other Cooking Functions

Broiling and toasting21
 Convection baking20
 Warming and proofing22

Microwaving

Cook by time24
 Cooking tips23
 Defrost by food type26
 Defrost by time25
 Defrosting tips25
 Express25
 Favorite Recipes25
 Microwave power level(s)24
 Microwave-safe cookware8
 Precautions to avoid possible
 exposure to excessive
 microwave energy4
 Sensor cooking27, 28
 Things that are normal23
 Using pre-set
 microwave selections24

Other Features

Automatic fans30
 Auto recipe convert29
 Beeper volume29
 Control lockout30
 Clock29
 Cook time completed28
 Delay Start29
 Display ON/OFF29
 Help30
 Reminder29
 Review29
 Scroll speed29
 Timer30

Care and Cleaning

Cleaning the halogen lamps
 and mica sheet32
 Cleaning the inside31
 Cleaning the outside and
 storage drawer (on some models)33
 Cooking trays and wire rack32
 Removable turntable31

Troubleshooting

Problem Solver35, 36

Consumer Support

Consumer Support39
 WarrantyBack Cover

Before using your oven

Read this manual carefully. It is intended to help you operate and maintain your new oven properly.

Keep it handy for answers to your questions.

If you don't understand something or need more help, there is a list of toll-free consumer service numbers included in the back section of this manual.

OR

Visit our Website at: **monogram.com**

Write down the model & serial numbers

You'll find them on a label under the oven.

Fill out and return the Consumer Product Registration Card that is packed with this product.

Before sending in the card, please write the numbers here:

Model Number

Serial Number

Use these numbers in any correspondence or service calls concerning your cooktop.

If you received a damaged oven

Immediately contact the dealer (or builder) that sold you the oven.

Save time & money

Read this manual. Inside you will find many helpful hints on how to use and maintain your oven properly. Just a little preventive care on your part can save you a great deal of time and money over the life of your oven.

You'll find many answers to common problems in the Before You Call for Service section. If you review our chart of Troubleshooting Tips first, you may not need to call for service at all.

If you need service

To obtain service, see the Consumer Services page in the back of this manual.

We're proud of our service and want you to be pleased. If for some reason you are not happy with the service you receive, here are some steps to follow for further help.

FIRST, contact the people who serviced your appliance. Explain why you are not pleased. In most cases, this will solve the problem.

NEXT, if you are still not pleased, write all the details—including your phone number—to:

Manager, Customer Relations
GE Appliances
Appliance Park
Louisville, KY 40225

IMPORTANT SAFETY INSTRUCTIONS

Advantium Oven

PRECAUTIONS TO AVOID POSSIBLE EXPOSURE TO EXCESSIVE MICROWAVE ENERGY

- (a) Do Not Attempt** to operate this oven with the door open since open-door operation can result in harmful exposure to microwave energy. It is important not to defeat or tamper with the safety interlocks.
- (b) Do Not Place** any object between the oven front face and the door or allow soil or cleaner residue to accumulate on sealing surfaces.
- (c) Do Not Operate** the oven if it is damaged. It is particularly important that the oven door close properly and that there is no damage to the:
 - (1) door (bent),
 - (2) hinges and latches (broken or loosened),
 - (3) door seals and sealing surfaces.
- (d) The Oven Should Not** be adjusted or repaired by anyone except properly qualified service personnel.

▲ NOTICE

PACEMAKERS

Most pacemakers are shielded from interference from electronic products, including microwaves. However, patients with pacemakers may wish to consult their physicians if they have concerns.

IMPORTANT SAFETY INSTRUCTIONS

Advantium Oven

▲ WARNING! *To reduce the risk of burns, electric shock, fire, injury to persons, or exposure to excessive microwave energy:*

SAFETY PRECAUTIONS

- **Read all instructions before using this appliance. When using electrical appliances, basic safety precautions should be followed, including the following:**
- Read and follow the specific precautions in the *PRECAUTIONS TO AVOID POSSIBLE EXPOSURE TO EXCESSIVE MICROWAVE ENERGY* section on page 2.
- Be sure your appliance is properly installed and grounded by a qualified technician in accordance with the provided installation instructions.
- Install or locate this appliance only in accordance with the provided installation instructions.
- Some products such as whole eggs and sealed containers—for example, closed jars—are able to explode and should not be heated in this oven. Such use of the oven could result in injury.
- Do not mount this appliance over a sink.
- This oven is not approved or tested for marine use.
- This oven is UL listed for standard wall installation above 36 inches.
- Do not operate this appliance if it has been damaged or dropped.
- As with any appliance, close supervision is necessary when used by children.
- Use this appliance only for its intended use as described in this manual.
- Do not use corrosive chemicals or vapors in this appliance.
- This oven is specifically designed to heat, dry or cook food, and is not intended for laboratory or industrial use.
- This appliance must only be serviced by qualified service personnel. Contact nearest authorized service facility for examination, repair or adjustment.
- Do not cover or block any openings on the appliance.
- Do not store this appliance outdoors. Do not use this product near water—for example, in a wet basement, near a swimming pool, near a sink or in similar locations.
- See door surface cleaning instructions in the *Care and Cleaning of the Oven* section of this manual.
- To reduce the risk of fire in the oven cavity:
 - Do not overcook food. Carefully attend appliance when paper, plastic or other combustible materials are placed inside the oven while cooking.
 - Remove wire twist-ties and metal handles from paper or plastic containers before placing them in the oven.
 - Do not use the oven for storage purposes. Do not leave paper products, cooking utensils or food in the oven when not in use.
 - Do not use the Sensor Features twice in succession on the same food portion. If food is undercooked after the first countdown, use COOK BY TIME for additional cooking time.
 - Do not use the oven to dry newspapers.
- If materials inside the oven ignite, keep the oven door closed, turn the oven off and shut off power at the fuse or circuit breaker panel. If the door is opened, the fire may spread.
- The wire oven rack should not be used for speedcook or microwave cooking to prevent arcing.

IMPORTANT SAFETY INSTRUCTIONS

Advantium Oven

▲ **WARNING!**

SAFETY PRECAUTIONS

- Do not operate the oven without the turntable in place. The turntable must be unrestricted so it can turn.
- During and after use, do not touch, or let clothing or other flammable materials contact any interior area of the oven; allow sufficient time for cooling first.
- Potentially hot surfaces include the oven door, floor, walls, oven rack and turntable.
- Keep the oven free from grease buildup.
- Cook meat and poultry thoroughly—meat to at least an INTERNAL temperature of 160°F, and poultry to at least an INTERNAL temperature of 180°F. Cooking to these temperatures usually protects against foodborne illness.

ARCING

Arcing can occur during both speedcooking and microwave cooking. If you see arcing, press the CLEAR/OFF pad and correct the problem.

Arcing is the microwave term for sparks in the oven. Arcing is caused by:

- Metal or foil touching the side of the oven.
- Foil not molded to food (upturned edges act like antennas).
- Use foil only as recommended in this manual.
- Metal cookware or the wire oven rack used during either speedcook or microwave cooking (except for the pans provided with the oven).
- Metal, such as twist-ties, poultry pins, or gold-rimmed dishes, in the oven.
- Recycled paper towels containing small metal pieces being used in the oven.

FOODS

- When microwaving, place all foods and containers on the clear glass tray.
- Do not pop popcorn in your oven unless in a special microwave popcorn accessory or unless you use popcorn labeled for use in microwave ovens.
- Do not boil eggs in this oven. Pressure will build up inside egg yolk and will cause it to burst, possibly resulting in injury.
- Do not operate oven without food inside. This may cause damage to the oven. It increases the heat around the magnetron and can shorten the life of the oven.
- Foods with unbroken outer “skin” such as potatoes, hot dogs, sausages, tomatoes, apples, chicken livers and other giblets, and egg yolks should be pierced to allow steam to escape during cooking.

■ **SUPERHEATED WATER**

Liquids, such as water, coffee or tea, are able to be overheated beyond the boiling point without appearing to be boiling. Visible bubbling or boiling when the container is removed from the microwave oven is not always present. THIS COULD RESULT IN VERY HOT LIQUIDS SUDDENLY BOILING OVER WHEN THE CONTAINER IS DISTURBED OR A SPOON OR OTHER UTENSIL IS INSERTED INTO THE LIQUID.

To reduce the risk of injury to persons:

- Do not overheat the liquid.
- Stir the liquid both before and halfway through heating it.
- Do not use straight-sided containers with narrow necks.
- After heating, allow the container to stand in the microwave oven for a short time before removing the container.
- Use extreme care when inserting a spoon or other utensil into the container.

IMPORTANT SAFETY INSTRUCTIONS

Advantium Oven

▲ WARNING!

Oven-safe cookware for Speedcooking



The **turntable** must always be in place when using the oven.



Put food directly on the **metal grill tray** to speedcook.

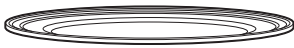

Put food directly on the **metal tray** to convection bake, warm or toast.

- The oven and door will get very hot when speedcooking.
- Cookware will become hot. Oven mitts will be needed to handle the cookware.
- Do not use coverings, containers or cooking/roasting bags made of foil, plastic, wax or paper when speedcooking.
- Do not cover the turntable, metal trays or any part of the oven with metal foil. This will cause arcing in the oven.
- Use the metal tray in the same way you would use a shallow baking pan or baking tray.
- Do not use the wire oven rack for speedcook.
- Place food directly on the metal trays when cooking unless prompted by the oven to do otherwise.
- Any non-metal oven-safe dish can be used in your oven. Recipes in the Advantium Cookbook were tested in Pyrex® glass cookware and Corningware® ceramic casseroles. Cook times and results may vary when using other types of oven-safe dishes. Place them directly on the trays.
- Use of the clear glass tray when speedcooking will result in inferior cooking performance and possible cracking of the glass tray.
- Use only the metal trays specified for use with this oven. Other metal trays are not designed for use with this oven and will result in inferior cooking performance.

Oven-safe cookware for Convection Baking, Broiling, Warming, Proofing & Toasting

- The oven and door will get very hot when convection baking, broiling, warming or toasting.
- Cookware will become hot. Oven mitts will be needed to handle the cookware.
- Do not cover dishes or use plastic containers, plastic cooking/roasting bags, plastic wrap, wax paper or paper when broiling or toasting.
- Do not cover the turntable, wire oven rack, trays or any part of the oven with metal foil. This will cause arcing in the oven if microwave or speedcook modes are used.
- Use the metal tray in the same way you would use a shallow baking pan or baking tray.
- Use the wire oven rack when convection baking or warming on two levels.
- Place food directly on the metal trays when cooking unless the recipe requires a dish.
- Any oven-safe dish can be used in your oven. Recipes in the Advantium Cookbook were tested in Pyrex® glass cookware and Corningware® ceramic casseroles. Cook times and results may vary when using other types of oven-safe dishes. Place them directly on the trays.
- Use of the clear glass tray when convection baking, broiling, warming or toasting will result in inferior cooking performance.



The **turntable** must always be in place when using the oven.

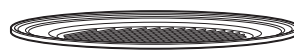

Put food directly on the **metal grill tray** as required to broil.



Put food or oven-safe cookware directly on the **metal tray** to convection bake, warm or toast.



Put food directly on the metal tray, or in the appropriate dish and place on **wire oven rack** when baking or warming on two levels.

IMPORTANT SAFETY INSTRUCTIONS

Advantium Oven

▲ WARNING!

Microwave -safe cookware



The **turntable** must always be in place when using the oven.



The **clear glass tray** should always be in place when **microwaving**.

Make sure to use suitable cookware during microwave cooking. Most glass casseroles, cooking dishes, measuring cups, custard cups, pottery or china dinnerware which does not have metallic trim or glaze with a metallic sheen can be used. Some cookware is labeled "suitable for microwaving."

- Do not use the wire oven rack for microwave.
- Place food or microwavable container directly on the clear glass tray to cook your food.
- Use of a metal tray during microwave cooking will result in inferior cooking performance.
- If you are not sure if a dish is microwave-safe, use this test: Place both the dish you are testing and a glass measuring cup filled with 1 cup of water in the oven. Set the measuring cup either in or next to the dish. Microwave 30-45 seconds at high. If the dish heats, it should not be used for microwaving. If the dish remains cool and only the water in the cup heats, then the dish is microwave-safe.
- Cookware may become hot because of heat transferred from the heated food. Oven mitts may be needed to handle the cookware.
- Use foil only as directed in this manual. When using foil in the oven, keep the foil at least 1" away from the sides of the oven.
- If you use a meat thermometer while cooking, make sure it is safe for use in microwave ovens.
- Some foam trays (like those that meat is packaged on) have a thin strip of metal embedded in the bottom. When microwaved, the metal can burn the floor of the oven or ignite a paper towel.



How to test for a microwave-safe dish.

- Do not use recycled paper products. Recycled paper towels, napkins and waxed paper can contain metal flecks which may cause arcing or ignite. Paper products containing nylon or nylon filaments should be avoided, as they may also ignite.
- Paper towels, waxed paper and plastic wrap can be used to cover dishes in order to retain moisture and prevent spattering. Be sure to vent plastic wrap so steam can escape.
- Not all plastic wrap is suitable for use in microwave ovens. Check the package for proper use.
- "Boilable" cooking pouches and tightly closed plastic bags should be slit, pierced or vented as directed by package instructions. If they are not, plastic could burst during or immediately after cooking, possibly resulting in injury. Also, plastic storage containers should be at least partially uncovered because they form a tight seal. When cooking with containers tightly covered with plastic wrap, remove covering carefully and direct steam away from hands and face.
- Plastic cookware—Plastic cookware designed for microwave cooking is very useful, but should be used carefully. Even microwave-safe plastic may not be as tolerant of overcooking conditions as are glass or ceramic materials. Plastic may soften or char if subjected to short periods of overcooking. In longer exposures to overcooking, the food and cookware could ignite.

Follow these guidelines:

1. Use microwave-safe plastics only, and use them in strict compliance with the cookware manufacturer's recommendations.
2. Do not microwave empty containers.
3. Do not permit children to use plastic cookware without adult supervision.

IMPORTANT SAFETY INSTRUCTIONS

Advantium Oven

▲ WARNING!

SAFETY PRECAUTIONS

- Don't defrost frozen beverages in narrow-necked bottles (especially carbonated beverages). Even if the container is open, pressure can build up. This can cause the container to burst, possibly resulting in injury.
- Foods cooked in liquids (such as pasta) may tend to boil more rapidly than foods containing less moisture. Should this occur, refer to the *Care and Cleaning of the oven* section for instructions on how to clean the inside of the oven.
- Hot foods and steam can cause burns. Be careful when opening any containers of hot food, including popcorn bags, cooking pouches and boxes. To prevent possible injury, direct steam away from hands and face.
- Do not overcook potatoes. They could dehydrate and catch fire, causing damage to your oven.
- Avoid heating baby food in glass jars, even with the lid off. Make sure all infant food is thoroughly cooked. Stir food to distribute the heat evenly. Be careful to prevent scalding when warming formula. The container may feel cooler than the formula really is. Always test the formula before feeding the baby.
- Do not attempt to deep fry in the oven.
- Do not use the oven to dry newspapers.

SAVE THESE INSTRUCTIONS

Getting to know the Advantium

The Advantium oven uses breakthrough Speedcook technology to harness the power of light. The Advantium oven cooks the outside of foods much like conventional radiant heat, while also penetrating the surface so the inside cooks simultaneously.

While halogen light is the primary source of power, a convection system and ceramic heater assist in the cooking, with a "microwave boost" added in some cooking algorithms. Food cooks evenly and fast, retaining its natural moisture.

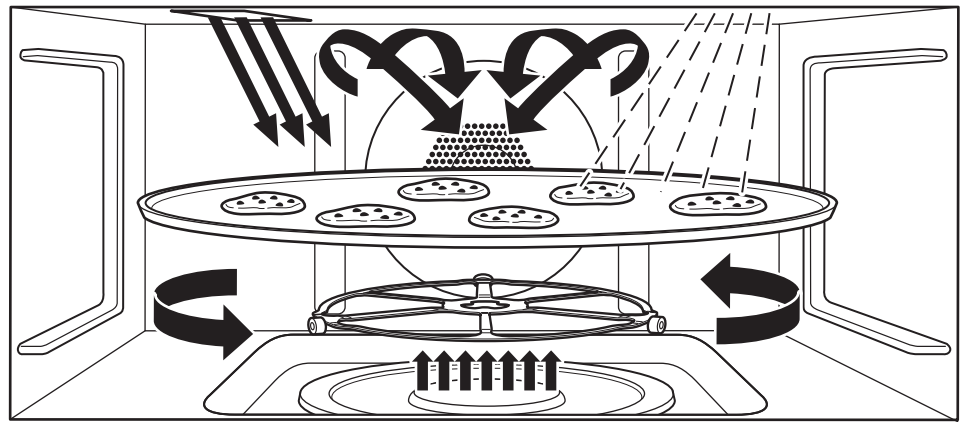

The Advantium oven is capable of speedcooking, convection baking, broiling, toasting, warming, proofing and microwaving. The Speedcook feature is the biggest benefit of the Advantium oven.

No preheating is required to speedcook. Place the food in the oven and start cooking immediately. You see timesaving because there is no preheat and because speedcook cooks faster.

Oven Features

Advantium Oven

Oven features

Throughout this manual, features and appearance may vary from your model.

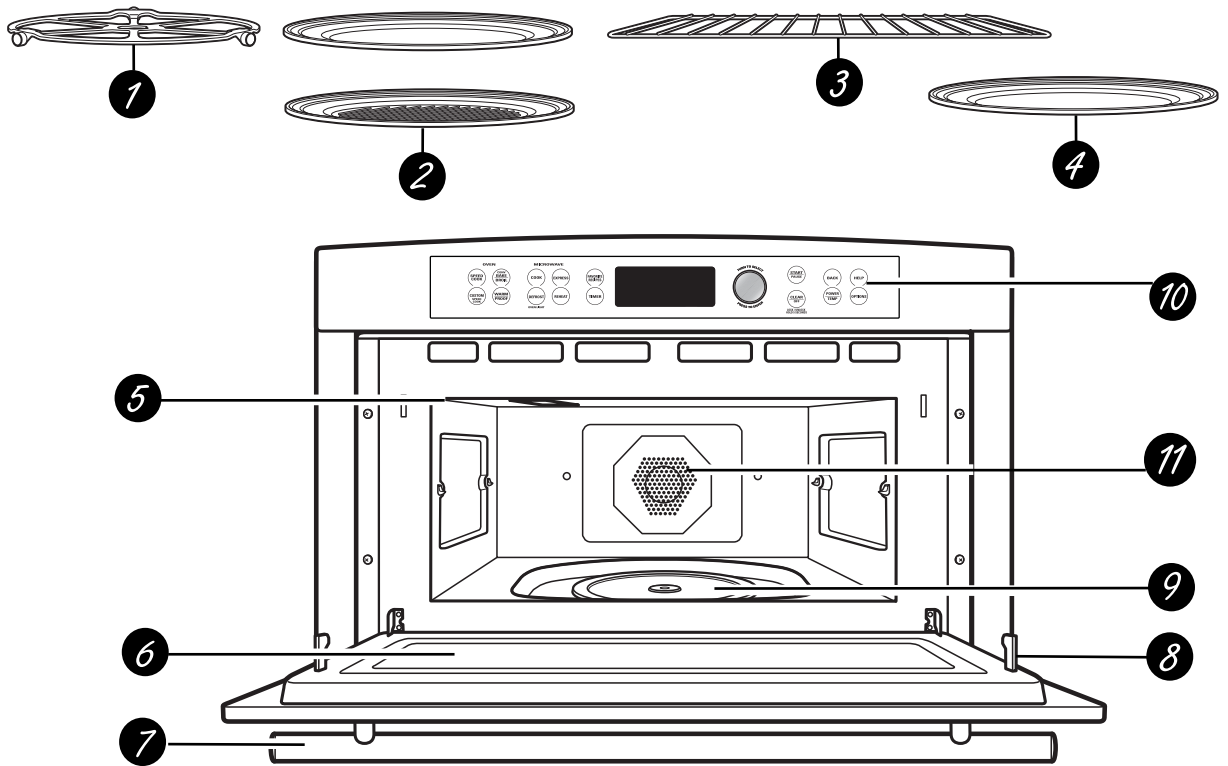

- 1** *Turntable*
The turntable must always be in place, on the oven floor, for all cooking. Be sure the turntable is seated securely over the spindle in the center of the oven with the marked side facing up.
- 2** *Metal Tray or Metal Grill Tray*
Put food directly on the metal tray or metal grill tray and place on the turntable when using the speedcook, broil, toast, warm and convection bake features.
- 3** *Wire Oven Rack*
Put food directly on the metal tray or in an oven-safe dish on the wire oven rack only when convection baking on two levels.
- 4** *Clear Glass Tray*
Place on turntable when using microwave features. Place food or microwave-safe cookware directly on tray.
- 5** *Upper Halogen Lamps*
Two 1200W halogen lamps cook food from above in speedcook, broil and toast.
- 6** *Window*
Allows cooking to be viewed while keeping microwaves confined in the oven.
- 7** *Door Handle*
Pull to open the door.
- 8** *Door Latches*
The door must be securely latched for the oven to operate.
- 9** *Lower Ceramic Heater*
One 500W ceramic heater cooks food from the bottom in speedcook, broil and toast.
- 10** *Control Panel*
The pads used to operate the oven are located on the control panel.
- 11** *Rear Convection System*
One 1500W heating element cooks food with a convection fan circulating the hot air throughout the cavity in speedcook, broil, convection bake, toast and warm.

Cooking controls

With your Advantium oven, you can cook with high-intensity halogen lights, ceramic heaters, convection heating element, and/or conventional microwave energy.

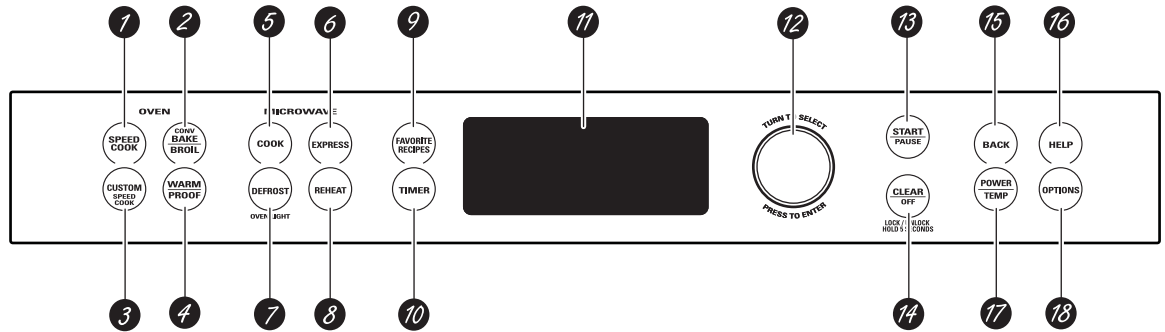

- 1** **SPEEDCOOK/Repeat Last**
Press this pad to access the pre-set speedcook menu. Press and hold for 3 seconds to repeat the last cooking selection.
- 2** **CONVECTION BAKE/BROIL**
Press this pad to convection bake, broil or toast.
- 3** **CUSTOM SPEEDCOOK**
Press this pad to set your own speedcook program.
- 4** **WARM/PROOF**
Select WARM to keep hot, cooked foods at serving temperature. Select PROOF to create a warm environment useful for raising yeast-leavened products.
- 5** **COOK (Microwave)**
Press this pad to microwave food.
- 6** **EXPRESS (Microwave)**
Press for 30 seconds of microwave cooking time. Each time the pad is pressed an additional 30 seconds is added to the remaining cooking time. The oven starts immediately.
- 7** **DEFROST (Microwave)/OVEN LIGHT**
Press this pad to defrost frozen foods, soften or melt. While cooking, press this pad to light the cavity for 4 seconds.
- 8** **REHEAT (Microwave)**
Press this pad to reheat previously cooked foods, a plate of leftovers or beverages.
- 9** **FAVORITE RECIPES**
Press this pad to add, edit (change) or remove a recipe from the memory.
- 10** **TIMER**
Press this pad to set the minute timer.
- 11** **Display**
Shows and instructs the use of all features on the oven.
- 12** **SELECTOR DIAL—Turn to select, press to enter** First turn, then press the dial to make option, food, power level or temperature selections. Also use the dial to increase (turn clockwise) or decrease (turn counterclockwise) cooking times.
- 13** **START/PAUSE**
Press this pad to start or pause any cooking function.
- 14** **CLEAR/OFF**
Press this pad to cancel **ALL** oven programs except the control lock, clock and timer.
- 15** **BACK**
Press this pad to step back one or more levels in the program process.
- 16** **HELP**
Press this pad to find out more about your oven's features.
- 17** **POWER/TEMP**
During cooking, press this pad and turn/press the selector dial to change the microwave power level, the convection bake temperature or the speedcook power levels.
- 18** **OPTIONS**
Press this pad to set the *Clock* and access the *Beeper Volume*, *Auto Recipe Convert*, *Clock Display ON/OFF*, *Display Scroll Speed*, *Delay Start* and *Reminder* features.

Using speedcook features

CAUTION: When using speedcook programs, remember that the oven, door and dishes will be very hot!

Prior to the first use of your oven, the clock must be set. See the Clock section.

Before you begin, make sure the turntable is in place with the side marked "TOP" facing up. Use the metal tray or metal grill tray and your own glass or ceramic cookware, if needed.



The **turntable** must always be in place when using the oven.

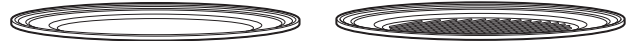

Put food directly on the **metal tray or metal grill tray to speedcook**.

- If the door is opened during cooking, the oven will stop and PAUSE will appear in the display. Close the door and press the START/PAUSE pad to resume cooking.
- At any time during cooking you can turn the selector dial to change the cooking time. You can change power levels by pressing POWER/TEMP.
- Speedcooking meats in the oven may produce smoke.
- To cook for additional time after a cooking cycle has been completed, use the Resume feature as instructed on the display.

Things that are normal

Cooking Times

- When speedcooking preprogrammed foods, you may see *OPTIMIZING COOK TIME* in the display several seconds after you press START/PAUSE. The oven automatically senses the electrical voltage level in your home and adjusts the cooking time up or down for proper cooking.

Cooling Fans

- The fans will be on during cooking. At the end of cooking, the fans may continue to run for a short time to cool internal components. The fans will automatically shut off when the internal parts of the oven have cooled.
- The oven vent will emit warm air while the oven is on.

Lights

- When the oven is on, light may be visible around the door or outer case.
- The halogen lights will dim and cycle on and off during a speedcook cycle, sometimes even at full power levels. This is normal. The oven senses the heat level and adjusts automatically.

Oven Heat

- No preheating time is required during Speedcook cycles. The oven begins cooking immediately.
- The door and inside of the oven will be very hot. Use caution when opening the door and removing food. Be cautious of steam or vapor that may escape from around the door.
- Do not use cookware or coverings made of paper, plastic, or foil when speedcooking.
- When cooking for an extended period of time, the oven may automatically reduce the power levels to maintain the appropriate level of oven heat.

Sounds

- Clicks and a fan blowing are normal sounds during cooking. The electronic control is turning components on and off.

Interference

- TV/radio interference might be noticed while using the microwave, similar to the interference caused by other small appliances. It does not indicate a problem with the microwave. Move the radio or TV as far away from the microwave as possible, or check the position of the TV/radio antenna.

Cooking tips for best results

To ensure consistent and even browning when cooking foods directly on the metal tray, arrange food as shown below.

Foods can touch but should not overlap.

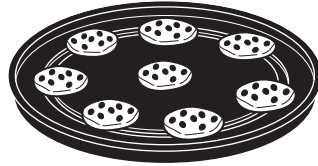

Circular pattern
(Example: biscuits, cookies)



Side by side pattern
(Example: meats and poultry)



Spoke pattern
(Example: crescent rolls, breadsticks)

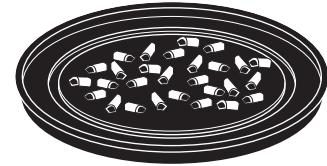

Single layer
(Example: appetizers)

Fresh meat, chicken, fish or seafood that has been frozen should be thawed before cooking. (The microwave defrost feature can be used.) For other frozen prepackaged foods, follow package directions.

Speedcook cookware

- Follow cookware suggestions on the oven display or in the Cookbook or Cooking Guide.
- Cookware will become hot. Oven mitts will be needed to handle the cookware.
- Place food directly on the metal tray or metal grill tray when cooking, unless prompted by the oven to do otherwise.
- Use the metal tray in the same way you would use a shallow baking pan or baking tray.
- In addition to the cookware provided, you can use non-metal casserole dishes, pie plates and other heat-safe cookware. Place them directly on the turntable.



- Be sure to select a size that will rotate easily.
- Place the metal tray or metal grill tray on the turntable. Place glass or ceramic cookware on the tray.
- Do not use cookware or coverings made of paper, plastic, or foil when cooking during a speedcook cycle.

Speedcook power level

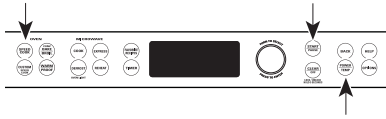

The Advantium uses power from high intensity halogen lamps, a ceramic heater, a convection system and microwaves to cook food from the top, bottom and interior simultaneously to seal in moisture and flavor.

When using the pre-set menu foods, the power levels are already selected for you. However, power levels can be adjusted when using pre-set menu foods and CUSTOM SPEEDCOOK.

Each power level gives you halogen lamp or ceramic heater power and microwave energy for a certain percentage of the time or provides heating from the convection system.

For example:

- U-07 Upper halogen lamp on 70% of the time.
- L-07 Lower ceramic heater on 70% of the time.
- C-06 Convection element heats oven to 350°F.
- M-05 Microwave on 50% of the time.

NOTE: Be careful when adjusting power levels so that you do not over- or undercook food.

1. Press the SPEEDCOOK pad and select your food (follow instructions from *Using the pre-set speedcook menu*).
2. When display shows ADJUST TIME or START, press the POWER LEVEL pad.

If you do not want to change one of the settings, just press the dial to move to the next selection.

3. Turn the dial clockwise to increase or counterclockwise to decrease the upper power level. Press the dial to enter.
4. Turn the dial to change the lower power level. Press the dial to enter.
5. Turn the dial to change the microwave power level. Press the dial to enter.
6. Turn the dial to change the convection power level. Press the dial to enter.
7. Press the START/PAUSE pad or the selector dial to start cooking.

Follow these general guidelines when selecting the best U=, L=, M= and C= settings for your favorite recipes:

U = Select a higher setting for thin foods requiring a golden brown top (example: fish fillets, toast, boneless chicken breasts). Select a lower setting for thicker foods and foods with high sugar or fat content (example: muffins, roasts, casseroles) or that require a longer cook time.

L = Select a higher setting for thick or dense foods that may not cook quickly in the center (example: steaks, casseroles). Select a lower setting for thin foods (example: cookies).

M = Select a higher setting to shorten cooking time for dense or heavy foods (example: casseroles, whole chicken). Select a lower setting for delicate foods (example: breads) or foods requiring longer cook times for tender results (example: stew, pot roast).

C = Select a lower setting for more delicate foods that cook at lower temperatures. Select a higher setting (6 or above) for more robust foods or foods that cook at temperatures above 350°F.

Using the pre-set speedcook menu



The Advantium is already pre-set to cook over 175 popular recipes.

1. Press the SPEEDCOOK pad.
If no selection is made within 15 seconds, the display will revert back to the time of day.
2. Turn the selector dial to select the type of food category you want. Press the dial to enter.
3. Turn the selector dial to select the specific food (menu selection). Press the dial to enter.
4. Turn the selector dial to select amount, size and/or doneness (if required, the oven will prompt you). Press the dial after each selection.

5. Once the display shows: ADJUST TIME or START press the START/PAUSE pad or the selector dial to start cooking.

Turn the food over when the oven signals TURN FOOD OVER (for certain foods).

When the oven signals CHECK for DONENESS, check to see if your food is done to your liking (for certain foods).

To review settings during cooking, press the selector dial.

If you enter an undesired selection at any time, simply press the BACK pad and re-enter the desired selections.

Speedcooking meats in the oven may produce smoke.

Pre-set speedcook menu selections

Food Category	Menu Selection	Food Category	Menu Selection	Food Category	Menu Selection
Appetizers	Bagel Bites Cheese Sticks Egg Rolls (Frozen) Hot Dip (2-4 Cups) Jalapeño Poppers Meat Balls (Frozen) Nachos Nuts, Roasted Onion Rings Pizza Rolls Quesadillas (fresh) Soft Pretzels (frozen) Taqitos (frozen)	Desserts	Brownies Cobbler (fresh 7x11) Coffee Cake Cookies Crisp (fresh 8x8) Pie (fresh fruit) Pie Crust Rolls (refrigerated) Turnovers	Poultry	Chicken, Bone-In Chicken, Boneless Chicken Fillet (frozen) Chicken Finger (frozen) Chicken, Fried (frozen) Chicken Nugget (frozen) Chicken Patty (frozen) Chicken Tender (frozen) Chicken Wings (frozen) Chicken, Whole Turkey
Breads	Bagels (frozen) Biscuits Bread Sticks (refrigerated) Cheese Bread Crescent Rolls Dinner Rolls Garlic Bread Muffin Mixes Quick Bread (mix) Sweet Rolls/Danish Taco Shells (boxed) Texas Toast	Entree	Burritos (frozen) Chimichanga (frozen) Egg Casserole (11x7) Egg Rolls (frozen) Enchilada (fresh) Lasagna Meatloaf (9x5) Quesadillas (fresh) Stuffed Peppers Taqitos (frozen)	Sandwich	Corn Dog (frozen) Crescent Roll Hot Dog Grilled Sandwich Hot Dog in a Bun Pocket Sandwich
Breakfast	Bagels (frozen) Belgian Waffles Breakfast Burritos Breakfast Pizza Coffee Cake French Toast Hashbrown Patties Pancakes (frozen) Rolls (refrigerated) Sausage Biscuit Sausage Strudel (frozen) Sweet Rolls/Danish Turnovers Waffles (frozen)	Meats	Filet Mignon Hamburger Lamb Chops Pork Chops Ribeye Steak Sirloin Steak Strip Steak T-Bone Steak Tenderloin	Seafood	Cod Fillets Fish Sticks (frozen) Frozen Breaded Lobster Tails Orange Roughy Fillet Salmon Sea Bass Shellfish Swordfish Steak (1") Tilapia Tuna Steaks Whitefish/Cod
		Pizza	Deli/Fresh Frozen Pizza Use Precooked Crust	Side Dish	Casserole Refried Beans (16 oz) Roasted Asparagus Roasted Bell Pepper Roasted Chilies Roasted Corn Roasted Garlic Roasted Mixed Vegetables Scalloped Potatoes Stuffing (mix) Stuffed Mushrooms Stuffed Tomatoes
		Potatoes	Baked Potato Hashbrown Patties Frozen Fries Frozen Nugget Sweet Potato/Yam		

Repeat last



Use this time saving feature for cooking repetitive items like cookies or appetizers.

NOTE: The last program used is stored for two hours.

1. Press and hold the SPEEDCOOK pad for 3 seconds.
2. The last pre-set food will be displayed.
3. Press the START/PAUSE pad or the selector dial to start cooking.

Resume feature



1. If your food needs to cook a bit longer, you can restart the oven by pressing the START/PAUSE pad or selector dial.
2. *RESUME COOKING* will be displayed and the oven will restart immediately at 10% of the original time.

The program stays in memory for 10 minutes. After that you will need to begin the program again. See *Using the pre-set speedcook menu*.

Custom speedcook



The Advantium gives you the flexibility to cook your favorite dishes.

If you want to cook a food item that is not among the pre-set selections, use custom speedcook.

1. Press the CUSTOM SPEEDCOOK pad.

If no entries are made within 15 seconds, the display will revert back to the time of day.

2. Turn the selector dial to select the cooking time. Press the dial to enter.

The display will prompt you to select the power level(s).

3. Turn the dial to select the upper power level. Turn the dial clockwise to increase or counterclockwise to decrease the upper power level. Press the dial to enter.

4. Turn the dial to select the lower power level. Press the dial to enter.
5. Turn the dial to select the microwave power level. Press the dial to enter.
6. Turn the dial to set the convection power level. Press the dial to enter.
7. Press the START/PAUSE pad or press the selector dial to start cooking.

For power level and cooking time suggestions, use your cooking guide, cookbook and the pre-set speedcook menu selections.

*Favorite recipe—
to enter
and save*



Add and save up to 30 of your own Speedcook or microwave recipes, or pre-set Speedcook menu recipes as a favorite recipe. Once it's done, you can quickly recall your favorite so that your food cooks just the way you want it every time!

1. Press the FAVORITE RECIPES or the SPEEDCOOK pad.
2. Turn the dial until *FAVORITE RECIPES* appears. Press the dial to enter. (Skip this step if the FAVORITE RECIPES pad was pressed in step 1.)
3. Turn the dial until *ADD RECIPE* appears. Press the dial to enter.
4. Turn the dial to *COPY SPEED RECIPE* or to *ADD NEW RECIPE*. Press the dial to enter.

If *COPY SPEED RECIPE* was selected, turn dial to food type(s) and press the FAVORITE RECIPES pad to enter and save the recipe.

If *ADD NEW RECIPE* was selected, turn the dial to select *SPEEDCOOK* or *MICROWAVE* recipe. Press the dial to enter and continue with these steps.

5. *SELECT COOK TIME* appears. Turn the dial to select the cooking time. Press the dial to enter.

The display will prompt you to select the power level(s).

6. Turn the dial clockwise to increase or counterclockwise to decrease the power level(s). Press the dial to enter.

For power level and cooking time suggestions, use your cooking guide or cook book.

7. *SPELL THE FOOD NAME* appears. Turn the dial to the first letter of your food description and press the dial to enter. Continue this process to spell the rest of the food name. Press the START/PAUSE pad to save the recipe and its name.

*Favorite recipe—
to find
and use*



To find and use stored favorite recipes:

1. Press the FAVORITE RECIPES or the SPEEDCOOK pad.
2. Turn the dial until *FAVORITE RECIPES* appears. Press the dial to enter. (Skip this step if the FAVORITE RECIPES pad was pressed in Step 1.)
3. Turn dial to *USE FAVORITE RECIPE* and press to enter.
4. The recipe names you entered will appear.
5. Turn dial until the recipe you want is displayed and press the dial to enter.
6. Press the START/PAUSE pad or press the selector dial to start cooking.

Favorite recipe— to adjust or change

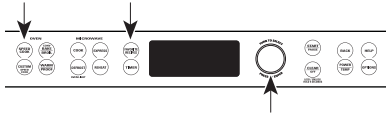

To adjust or change stored custom speedcook recipes:

1. Press the FAVORITE RECIPES or the SPEEDCOOK pad.
2. Turn the dial until FAVORITE RECIPES appears. Press the dial to enter. (Skip this step if the FAVORITE RECIPES pad was pressed in Step 1.)
3. Turn the dial until *EDIT RECIPE* appears. Press the dial to enter.
4. Turn the dial to the recipe you want to change. Press the dial to enter. Current settings appear.
5. Press the dial to edit.
6. The display will prompt you to select the power level(s) and edit the name. Turn the dial and press to enter the appropriate settings.

For power level and cooking time suggestions, use your cooking guide or cookbook.

Favorite recipe— to delete



To delete stored custom speedcook recipes:

1. Press the FAVORITE RECIPES or the SPEEDCOOK pad.
2. Turn the dial until FAVORITE RECIPES appears. Press the dial to enter. (Skip this step if the FAVORITE RECIPES pad was pressed in Step 1.)
3. Turn the dial until *DELETE RECIPE* appears and press the dial to enter.
4. Turn dial to the recipe you want to delete and press the dial to enter.

Convection Baking

Convection baking allows you to cook foods the same way as a conventional oven, using a heating element to raise the temperature of the air inside the oven. Any oven temperature from 250°F to 450°F may be set.

A fan gently circulates heated air throughout the oven, over and around the food. Because the heated air is kept constantly moving, not permitting a layer of cooler air to develop around the food, some foods cook slightly faster than in regular oven cooking.

Before you begin, make sure the turntable is in place. Use the metal tray at all times when single or two-level baking.



The **turntable** must always be in place when using the oven.



Put food or oven-safe cookware directly on the **metal tray**.



Put food directly on the metal tray or in the appropriate dish and place on **wire oven rack** when baking or warming on two levels.

CAUTION! When baking, remember that the oven, door and dishes will be very hot!

How to Convection Bake



1. Press CONVECTION BAKE/BROIL pad.
2. Press the dial to select CONV BAKE.
3. Turn the dial to set the oven temperature and press to enter.
2. When the oven is finished preheating, it will signal. If you do not open the door within 1 hour, the oven will turn off automatically. Open the oven door and, using caution, place the food in the oven.

To bypass preheating:

1. When the prompt shows *PREHEAT THE OVEN?* turn the dial to NO. Press the dial to enter.
2. Place food in oven, turn the dial to set the cook time and press to enter.
3. Press the dial or press START/PAUSE to start cooking. When cooking is complete, the oven will signal and turn off.
3. Close the oven door. Turn the dial to set the cook time and press to enter.
4. Press the dial or press START/PAUSE to start cooking. When cooking is complete, the oven will signal and turn off.

To preheat:

1. When the prompt shows *PREHEAT THE OVEN?* turn the dial to YES. Press the dial or press START/PAUSE to begin preheating.
The oven starts preheating immediately. Do not place food in oven. (You will be prompted to enter a cook time, after oven is preheated.)

You may change the oven temperature during preheating by pressing the **POWER/TEMP** pad and turning the dial to select the new temperature. Press the dial to enter.

If the oven door is opened during cooking, **PAUSE** will appear in the display. Close the door and press **START/PAUSE**.

Cook times are shown in minutes and can be set to a maximum of 179 minutes. Time can be changed during cooking by turning the dial.

Cooking Tips for Convection Baking

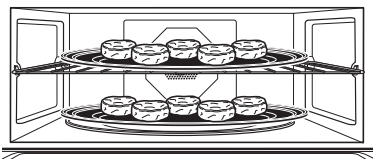

- When cooking items that go directly onto the metal tray, do not place the tray into the oven during preheat. Place the food directly onto the tray, and place the metal tray with food onto the turntable after the oven is finished preheating.
- When cooking items in a dish to be placed on the metal tray, place the metal tray in the oven during preheat for optimum cooking performance.
- For two-level baking, install the wire rack on the 4 rack supports and a metal tray on the turntable. Baking dishes can be placed directly onto the wire rack and the turntable.
- If baking trays are required for cooking foods like cookies or biscuits, use the metal trays supplied with the oven to place on the wire rack and on the turntable for best performance.

Broiling and Toasting

Broil and toast use the upper lamps, lower heater and convection system to broil or toast food similar to a conventional oven.

Before you begin, make sure the turntable is in place. Use the metal tray when toasting and the metal tray or metal grill tray when broiling.



The **turntable** must always be in place when using the oven.

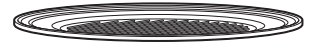

Put food directly on the **metal tray** or the **metal grill tray**.

CAUTION! When broiling or toasting, remember that the oven, door and dishes will be very hot!

How to Broil or Toast

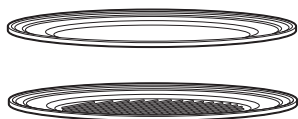

Put food directly on the **metal tray** or the **metal grill tray** to broil or toast food.

1. Press the CONV BAKE/BROIL pad.
2. Turn the dial to BROIL or TOAST and press to enter.

To bypass preheating:

1. When the prompt shows *PREHEAT THE OVEN?* turn the dial to NO. Press the dial to enter.
2. Place the food in the oven, turn the dial to set the cook time and press to enter.

Press the dial or START/PAUSE to start cooking. When cooking is complete, the oven will signal and turn off.

To preheat:

1. When the prompt shows *PREHEAT THE OVEN?* turn the dial to YES. Press the dial or press START/PAUSE to begin preheating.

The oven starts preheating immediately. Do not place the food in the oven. (You will be prompted to enter the cook time, after the oven is preheated.)

2. When the oven is finished preheating, it will signal. If you do not open the door within 1 hour, the oven will turn off automatically. Open the oven door and, using caution, place the food in the oven.
3. Close the oven door. Turn the dial to set the cook time and press the dial or START/PAUSE pad to begin cooking. When cooking is complete, the oven will signal and turn off.

If the oven door is opened during cooking, *PAUSE* will appear in the display. Close the door and press *START/PAUSE*.

Cooking Tips for Broiling

- Broiling times may be shorter in the Advantium oven because of the use of halogen lamps. Make sure to monitor food closely to get the desired results.
- For best results when broiling, place food directly on the metal grill tray.
- Broiling meats in the oven may produce smoke.
- If preheating the oven to broil meat, preheat with the metal grill tray in

the oven and place food on the hot metal tray for best searing of meat.

- Most foods should be turned halfway through broiling time. Dense foods such as meaty, bone-in chicken pieces should be turned about 3/4 of the way through broiling time.
- Remove thinner pieces as needed to prevent overcooking and drying.

Cooking Tips for Toasting

- For best results when toasting, use the metal tray.
- Most foods should be turned over 2/3 of the way through toasting time when not preheating.
- When using the preheat option, turn food halfway through the cooking time.

- To crisp exterior but maintain moistness inside foods, preheat the oven.
- To crisp exterior and crisp the inside too, do not preheat the oven.
- Toast thicker pieces a longer time, thinner pieces a shorter time.

Warming

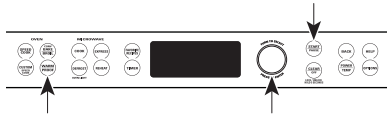

The **turntable** must always be in place when using the oven.



Put food or oven-safe cookware directly on the **metal tray** to warm.

The WARM feature will keep hot, cooked foods at serving temperature. Always start with hot food. Use cookware and utensils that can withstand temperatures up to 230°F.

1. Press the WARM/PROOF pad.
2. Turn the dial to select HOLD FOOD WARM. Press the dial to enter.
3. Turn the dial to select the oven temperature. See the chart and tips below. Press the dial to enter.

LOW	140–160°F
MEDIUM	160–195°F
HIGH	195–230°F

4. Turn the dial to select the level of moisture you want. See the chart and tips below. Press the dial to enter.

If the oven door is opened during warming, PAUSE will appear in the display. Close the door and press START/PAUSE.

To Crisp Stale Items:

- Place food or dishes directly on the metal tray.
- Select the LOW and CRISP settings. Preheat the oven for 10 minutes
- Check crispness after 45 minutes. Add time as needed.

Tips for Crisp Foods:

- Leave food uncovered.
- Do not use plastic containers or plastic wrap.
- Preheating is not necessary except for crisping stale items. (See To Crisp Stale Items.)

Tips for Moist Foods:

- Cover food with lid or aluminum foil.
- Do not use plastic containers or plastic wrap.
- Preheating is not necessary.

Temperature and Moisture Selection Chart

Food Type	Control Setting	Moisture Setting
Bread, hard rolls	MEDIUM	CRISP
Bread, soft rolls	MEDIUM	MOIST
Casseroles	MEDIUM	MOIST
Fried foods	HIGH	CRISP
Meats* and fish	MEDIUM	CRISP
Pancakes, waffles	HIGH	CRISP
Pizza	HIGH	CRISP
Potatoes, baked	HIGH	CRISP
Potatoes, mashed	MEDIUM	MOIST
Poultry	HIGH	MOIST
Tortilla Chips	LOW	CRISP
Vegetables	MEDIUM	MOIST

* USDA/FSIS recommends an internal temperature of 145°F as the minimum doneness for beef. Use a portable meat thermometer to check internal temperatures.

Proofing



The **turntable** must always be in place when using the oven.



Put bread dough in a bowl/bread pan and place on the **metal tray** to proof.

The proofing feature automatically provides the optimum temperature for the proofing process, and therefore does not have a temperature adjustment.

1. Press the WARM/PROOF pad.
2. Turn the dial to select PROOF BREAD. Press the dial to enter. The oven starts proofing immediately and shows the amount of proofing time completed.

- To avoid lowering the oven temperature and lengthening proofing time, do not open the oven door unnecessarily.

- Check bread products early to avoid over-proofing.

NOTES:

- Do not use the proofing mode for warming food or keeping food hot. The proofing oven temperature is not hot enough to hold foods at safe temperatures. Use the WARM feature to keep food warm.
- Proofing will not operate if the oven is too hot. Allow the oven to cool before proofing.

Using the microwave features

Make sure the turntable is in place with the side marked "TOP" facing up. Use the clear glass tray.

Place food or microwavable container directly on the clear glass tray to cook your food.



The **turntable** must always be in place when using the oven.



The **clear glass tray** should always be in place when **microwaving**.

Cookware

- Make sure that cookware is suitable for microwaving.
- Place food or microwavable container directly on the clear glass tray to cook your food.

MICROWAVE PRE-SET SELECTIONS		
<p>■ Cook</p> <ul style="list-style-type: none"> -By Food Type -By Time -By Time 1 & 2 -Delay Start -Heat/Reheat Beverage -Melt -Slow Cook -Soften 	<p>■ Defrost</p> <ul style="list-style-type: none"> -1.0 lb Quick -By Time -By Food Type -By Weight -Delay Start -Melt -Soften 	<p>■ Reheat</p> <ul style="list-style-type: none"> -Beverage -Casserole -Chicken -Pasta -Pizza -Plate of Food -Rice -Soup -Steaks/Chops -Vegetables

Things that are normal

Interference

- TV/radio interference might be noticed while using the microwave, similar to the interference caused by other small appliances. It does not indicate a problem with the microwave. Move the radio or TV as far away from the microwave as possible, or check the position of the TV/radio antenna.

Oven Heat

- Cookware may become hot because of heat transferred from the heated food. Oven mitts may be needed to handle the cookware.
- Steam or vapor may escape from around the door.

Lights

- The oven cavity light will not come on during any cooking cycle. To view food in the oven, press the DEFROST pad while cooking to light the cavity for 4 seconds.

Cooking tips

- When cooking bacon, layer strips on a plate. Cover each layer with a paper towel.
- When cooking vegetables, use a microwave-safe casserole or bowl. Cover with a microwave-safe lid or vented plastic wrap.
- For frozen vegetables, follow the package instructions for adding water.
- For fresh vegetables, add 2 tablespoons of water for each serving.

Microwave power level(s)

The microwave power level is automatically set on all microwave features but you can change it on some features for more flexibility.



1. First, follow directions for COOK BY TIME, COOK BY TIME 1 & 2, EXPRESS or DEFROST BY TIME.
 2. Press the POWER/TEMP pad.
 3. Turn the dial clockwise to increase and counterclockwise to decrease power level. Press the dial to enter.
 4. Press the dial or the START/ PAUSE pad to start cooking.
- You can change the power level before or during a cooking program.

Here are some examples of uses for various power levels:

High 10: Fish, bacon, vegetables, boiling liquids.

Med-High 7: Gentle cooking of meat and poultry; baking casseroles and reheating.

Medium 5: Slow cooking and tenderizing for stews and less tender cuts of meat.

Low 2 or 3: Defrosting; simmering; delicate sauces.

Warm 1: Keeping food warm; softening butter.

How to use pre-set microwave selections



1. Press the microwave COOK, DEFROST or REHEAT pad.

If no selection is made within 15 seconds, the display will revert back to the time of day.

2. Turn the dial to find the food you want to cook, defrost or reheat. Press the dial to enter.
3. Turn the selector dial to select the type, amount, weight and/or size as prompted by the oven. Press the dial after each selection.

4. Press the dial or the START/PAUSE pad to start cooking.

To review settings during cooking, press the selector dial.

If the door is opened during cooking, the oven will stop and PAUSE will appear in the display. Close the door and press START/ PAUSE to resume cooking.

If you enter an undesired selection at any time, simply press the BACK pad and re-enter the desired selections.

Cook By Time and Cook By Time 1 & 2



Use COOK BY TIME and COOK BY TIME 1 & 2 to microwave food that is not in the recipe section and at the time(s) you set.

1. Press the COOK pad.
2. Turn the dial to select COOK BY TIME or COOK BY TIME 1 & 2 and press the dial to enter.
3. Turn the dial to set the cook time and press the dial to enter.

If you selected COOK BY TIME 1 & 2, turn the dial to set the second cook time and press the dial to enter.

The power level is automatically set at high, but you can change it for more flexibility.

To change the power level if you don't want full power, press the POWER/TEMP pad before entering the time(s). Turn the dial to select and press the dial to enter.

4. Press the dial or the START/ PAUSE pad to start cooking.

You may open the door during COOK BY TIME and COOK BY TIME 1 & 2 to check the food. Close the door and press START/PAUSE to resume cooking.

Express



Press EXPRESS repeatedly for 30 second increments of microwave cooking time. Oven starts immediately.

- The power level is automatically set at high, but you can change it for more flexibility. (See *Microwave power levels* for instructions.)

Favorite recipes

See the Favorite recipe sections in the Speedcook section of this book for instructions on how to save, use, change or delete a favorite recipe.

Defrosting tips

Use *DEFROST BY FOOD TYPE* for meat, poultry and fish. Use *DEFROST BY TIME* for most other frozen foods.

- Foods frozen in paper or plastic can be defrosted in the package when using *DEFROST BY TIME*. Foods should be taken out of the package when using *DEFROST BY FOOD TYPE*. Closed packages should be slit, pierced or vented **after** food has partially defrosted. Plastic storage containers should be partially uncovered.
- Family-size, prepackaged frozen dinners can be defrosted and microwaved. If the food is in a foil container, transfer it to a microwave-safe dish.
- Foods that spoil easily should not be allowed to sit out for more than one hour after defrosting. Room temperature promotes the growth of harmful bacteria.
- For more even defrosting of larger foods, such as roasts, use *DEFROST BY TIME*. Be sure large meats are completely defrosted before cooking.
- When defrosted, food should be cool but softened in all areas. If still slightly icy, return to the microwave very briefly, or let it stand a few minutes.
- When defrosting 3 or more pounds of ground or cubed meat, remove defrosted portions at the turn signals.

Defrost by time



Use *DEFROST BY TIME* to defrost for a selected length of time.

1. Press the DEFROST pad.
2. Turn the selector dial to *DEFROST BY TIME*. Press the dial to enter.
3. Turn the dial to select the time you want. Press the dial to enter.
4. Press the dial or START/PAUSE pad to start defrosting.
5. Turn the food over when the oven signals *TURN FOOD OVER*.

- Power level is automatically set at 3, but can be changed. To change the power levels, see *Microwave power levels* for instructions.

You can defrost small items quickly by raising the power level after entering the time. Power level 7 cuts the total defrosting time in about half; power level 10 cuts the total time to about 1/3. When defrosting at high power levels, food will need more frequent attention than usual.

Defrost by food type

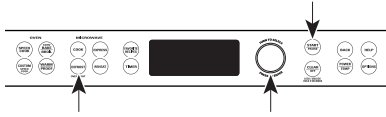

DEFROST BY FOOD TYPE automatically sets the defrosting times and power levels to give even defrosting results for meats, poultry and fish weighing up to 6 pounds.

1. Remove food from the package and place it on a microwave-safe dish.
2. Press the DEFROST pad.
3. Turn the dial to *DEFROST BY FOOD TYPE*. Press the dial to enter.
4. Turn the dial to select food type. Press the dial to enter.
5. Turn the dial to the food weight, using the Conversion Guide at right. For example, dial 1.2 for 1.2 pounds (1 pound, 3 oz.) Press the dial to enter.
6. Press the dial or START/PAUSE pad to start defrosting.
7. Turn the food over when the oven signals *TURN FOOD OVER*.

- Remove defrosted meat or shield warm areas with small pieces of foil for even defrosting.
- After defrosting, most meats need to stand 5 minutes to complete defrosting. Large roasts should stand for about 30 minutes.

Conversion Guide

If the weight of food is stated in pounds and ounces, the ounces must be converted to tenths (.1) of a pound.

Weight of Food in Ounces	Enter Food Weight (tenths of a pound)
1-2	.1
3	.2
4-5	.3
6-7	.4
8	.5
9-10	.6
11	.7
12-13	.8
14-15	.9

Microwave
sensor
cooking tips

The sensor feature detects the increasing humidity released during cooking. The oven automatically adjusts the cooking time to various types and amounts of food.

Do not use the sensor features twice in succession on the same food portion—it may result in severely overcooked or burnt food. If food is undercooked after the first countdown, use **COOK BY TIME** for additional cooking time.

The proper containers and covers are essential for best sensor cooking.

- Always use microwave-safe containers and cover them with lids or vented plastic wrap. Never use tight sealing plastic containers—they can prevent steam from escaping and cause food to overcook.
- Be sure the outside of the cooking containers and the inside of the oven are dry before placing food in the oven. Beads of moisture turning into steam can mislead the sensor.
- Beverages are best heated uncovered.

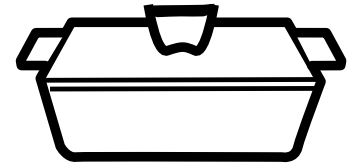

Covered

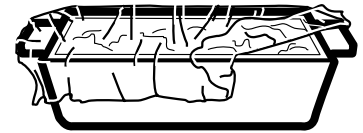

Vented

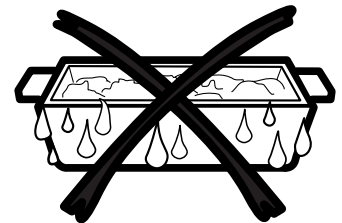

Dry off dishes so they don't mislead the sensor.

MICROWAVE SENSOR PROGRAMS

- | | |
|---|--------------------------------------|
| ■ Ground Meat | ■ Vegetables (Canned, Fresh, Frozen) |
| ■ Popcorn
(Prepackaged microwave popcorn,
3.0 oz. to 3.5 oz.) | ■ Chicken Reheat |
| ■ Soup | ■ Pasta Reheat |
| ■ Rice | ■ Plate of Food Reheat |
| | ■ Soup Reheat |
| | ■ Vegetable Reheat |

To use all sensor programs

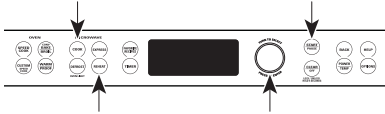

The Advantium's microwave mode features sensor cooking. The oven automatically senses when food is done and shuts itself off—eliminating the need to program cook times and power levels.

1. Press the COOK pad and turn the dial to COOK BY FOOD TYPE. Press the dial to enter. Or press the REHEAT pad.
2. Turn the dial to select the food you want. Press the dial to enter.
3. Press the dial or press the START/PAUSE pad to start cooking.

Do not open the oven door until time is counting down in the display. If the door is opened, close it and press START/PAUSE immediately.

NOTE: Do not use a sensor feature twice in succession on the same food portion—it may result in severely overcooked or burnt food. If the food is not done enough at the end of the sensor cook time, use *COOK BY TIME* in the microwave selector to cook for more time.

- If you have been cooking and the oven is hot, it may indicate that it is too hot for sensor cooking. In that case, the oven will automatically change to time cooking and may prompt for weights or amounts of food.

- To shorten or lengthen the cook time, wait until the time countdown shows in the display. Then turn the dial to add or subtract time.

- If you open the door while *SENSOR Cooking*, *SENSOR ERROR* will appear. Close the door immediately and press START/PAUSE to begin again.

Notes about the Reheat program:

Reheated foods may have wide variations in temperature. Some areas may be extremely hot.

It is best to use *COOK BY TIME* and not *REHEAT* for these foods:

- Bread products
- Food that must be reheated uncovered
- Foods that need to be stirred or turned
- Foods calling for a dry look or crisp surface after reheating.

"COOK TIME COMPLETED"

To remind you that you have food in the oven, the oven will display *COOK TIME COMPLETED* and beep once a minute until you either open the oven door or press the CLEAR/OFF pad.



Review



Use this feature to review the current cooking selections you have set.

Press the selector dial during speedcooking or microwave cooking.

Features under the OPTIONS pad



Clock:

The clock must be set before you can use your oven for the first time. When setting the clock time for the first time go directly to Step 2.

1. To change the clock time, press the OPTIONS pad and turn the dial to CLOCK. Press the dial to enter.
2. Turn the dial to set hours. Press the dial to enter.
3. Turn the dial to set minutes. Press the dial to enter.
4. Turn the dial to select AM or PM. Press the dial to enter.

Auto Recipe Convert:

Auto recipe conversion reduces the convection baking temperature automatically by 25°F when turned ON. You still input the recipe temperature and the oven control does the rest. To change the setting, press the OPTIONS pad and turn the dial to AUTO RECIPE CONVERT. Press the dial to enter. Turn the dial to change the setting to ON or OFF. Press the dial to enter.

Clock Display ON/OFF:

Use this feature to turn your clock display on or off. Press the OPTIONS pad, turn the dial to select CLOCK DISPLAY ON/OFF. Turn the dial to select ON or OFF. Press the dial to enter.

Delay Start:

Delay Start allows you to set the oven to delay cooking up to 24 hours. Press the OPTIONS pad, turn the dial to select DELAY START and press the dial to enter. Follow the display directions to set the Delay Start time and feature you wish to delay.

Beeper Volume:

Use this feature to adjust the volume of the beeper. You can even turn it off. Press the OPTIONS pad, turn the dial to select BEEPER VOLUME, press the dial to enter, and follow the display directions.

Scroll Speed:

Is the message scroll too slow or too fast? Change it! Press the OPTIONS pad, turn the dial to select DISPLAY SCROLL SPEED, press the dial to enter and follow the display directions.

Reminder:

Use this feature to set an alarm beep to sound at a specific time of day. Press the OPTIONS pad, turn the dial to SET/CLEAR REMINDER and press the dial to enter. Turn the dial to select the hour and press to enter. Turn the dial to select the minute and press to enter. Turn the dial to select AM or PM and press to enter.

To review the setting, turn the dial to SET/CLEAR REMINDER and press the dial to enter. Turn the dial to REVIEW and press to enter.

To cancel the setting, turn the dial to SET/CLEAR REMINDER and press the dial to enter. Turn the dial to CLEAR and press to enter.

Help



Use this feature to find out more about your oven and its features.

The display will show a description for the program you have chosen.

1. Press the HELP pad.
2. Turn the dial to select the feature name. Press the dial to enter.

Features found in the HELP function.

Adding Time	Defrost by Time	Sensor Cooking
Auto Recipe Convert	Defrost by Weight	Set Beeper Volume
Back	Delay Start	Set Clock
Beverage Reheat	Express Cook	Set Display On/Off
Broil	Favorite Recipes	Set Display Speed
Child Lockout	Help	Set/Clear Reminder
Clear/Off	Hold Food Warm	Slow Cook
Convection	Options	Soften/Melt
Cook	Power/Temp	Speed Cook
Cook by Food Type	Proof Bread	Start/Pause
Cook by Time	Reheat	Time Cook 1 & 2
Custom Speed Cook	Repeat Last	Timer On/Off
Defrost	Resume	Toast
Defrost by Food Type	Review	Warm/Proof

Control lock-out



You may lock the control panel to prevent the oven from being accidentally started or used by children.

When the control panel is locked, *Control is LOCKED* will be displayed briefly anytime a pad or dial is pressed.

Press and hold CLEAR/OFF for 5 seconds to lock and unlock.

Timer



Use this feature anytime you need a general purpose timer. It can even be used while cooking in the oven.

3. Turn the dial to select the minutes. Press the dial to enter.

1. Press the TIMER pad.
2. Turn the dial to select the hours. Press the dial to enter.

To cancel, press TIMER.

Cooling fans

Two cooling fans automatically turn on as required to keep the internal oven components and control from overheating.

The fans will automatically turn off when the internal parts are cool. One or both may stay on for 30 minutes or more after the oven control is turned off.

How to clean the inside of the oven and the accessory storage drawer (with some models)

Be certain the oven control is turned off and the oven is warm or cool to the touch before cleaning any part of this oven.

Clean the inside of the oven often for proper heating performance.

Some spatters can be removed with a paper towel, others may require a warm soapy cloth. Remove greasy spatters with a sudsy cloth, then rinse with a damp cloth.

If the dirt and spatter do not come off easily with a warm sudsy cloth, place a medium sized bowl full of water in the unit on the metal tray and CUSTOM SPEEDCOOK for 10 minutes at U=10, L=10, M=7, C=10. This should loosen the dirt in the oven so that it can be removed with a warm sudsy cloth.

If you notice yellowing on the metal inside the oven that cannot be removed with a warm sudsy cloth, use a stainless steel cleaner that removes heat discoloration and/or tarnishing. You can then clean the inside of the oven as you normally do.

Do not use abrasive cleaners or sharp utensils on oven walls or the accessory storage drawer.

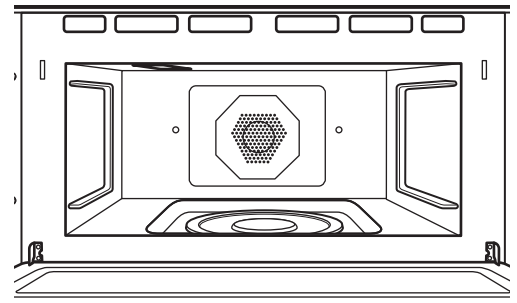

Never use a commercial oven cleaner on any part of your oven or the accessory storage drawer.

Do not clean the inside of the oven or the accessory storage drawer with metal scouring pads. Pieces can break off the pad inside the oven, causing electrical shock as well as damaging the inside surface finish of the oven or the accessory storage drawer.

Removable turntable

The area underneath the turntable should be cleaned frequently to avoid odors and smoking during a cooking cycle.

The turntable can be broken if dropped. Wash carefully in warm, sudsy water. Dry completely and replace.

To replace the turntable, place its center over the spindle in the center of the oven and turn it until it seats into place. (Make sure the smooth side of the turntable marked "TOP" is facing up and that its center seats on the spindle.)

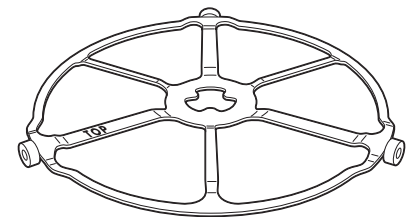

Turntable

Do not use the oven without the turntable in place.

Care and Cleaning

*Advantium Oven and
Accessory Storage Drawer
(with some models)*

Cooking trays and wire oven rack

To prevent breakage, allow the trays to cool completely before cleaning. Wash carefully in hot, sudsy water or in the dishwasher.

Do not use abrasives to clean the glass tray or wire oven rack, as they may damage the finish.

A soap-filled scouring pad may be used to clean the metal trays.



Clear glass tray



Wire oven rack



Metal tray



Metal grill tray

Halogen lamp cover and mica sheet

Do not remove the halogen lamp glass cover or the mica sheet.

The upper halogen lamp cover **must** be kept free of grease and food splatterings in order to operate effectively.

Clean the lamp glass cover and mica sheet often to avoid excess smoking and decreased cooking power.

To clean the upper lamp cover: Allow the oven and glass cover to cool completely. Wipe clean with a warm soapy cloth or plastic scrubbie.

For heavy burned on soil, a cleaning scraper may be used to clean the halogen lamp cover. Wearing an oven mitt, hold the cleaning scraper at a 30° angle. Scrape the glass clean and wipe up excess soil.

To clean the mica sheet: Allow the oven to cool completely. Wipe clean with a warm soapy cloth.

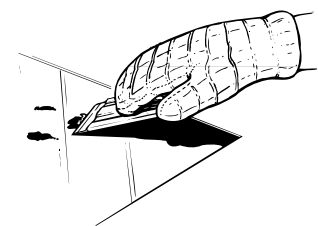
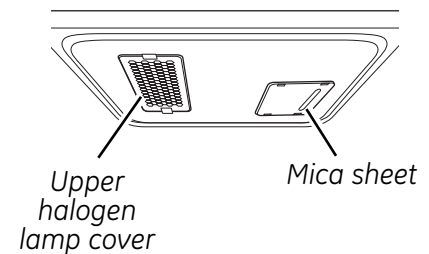

For heavy or burned on soil

*How to clean
the outside of
the oven and
the accessory
storage
drawer (with
some models)*

We recommend against using cleaners with ammonia or alcohol, as they can damage the appearance of the oven or the accessory storage drawer. If you choose to use a common household cleaner, first apply the cleaner directly to a clean cloth, then wipe the soiled area.

Glass Control Panel, Door and Drawer (on some models)

Wipe with a clean damp sponge. Dry thoroughly. Do not use cleaning sprays, large amounts of soap and water, abrasives or sharp objects on the panel—they can damage it.

Door Seal

It's important to keep the area clean where the door seals against the oven. Use only mild, non-abrasive detergents applied with a clean sponge or soft cloth. Rinse well.

***Stainless Steel
(on some models)***

To clean the stainless steel surface, use warm sudsy water or a stainless steel cleaner or polish. Always wipe the surface in the direction of the grain. Follow the cleaner instructions for cleaning the stainless steel surface.

To inquire about purchasing stainless steel appliance cleaner or polish, or to find the location of a dealer nearest you, please call our toll-free number, 800.626.2002 or visit ge.com.

*Accessory
storage
drawer (with
some models)*

The accessory storage drawer is designed to hold the cooking trays and wire oven rack provided with the oven. The accessory storage drawer is not intended for storing cloth, wood, paper or other combustible products.

Contents in the drawer can become hot to the touch while the oven is in use and while the oven is cooling. Use caution when removing items at these times.

Questions?
Use this
problem
solver

Problem	Possible Causes	What To Do/Explanation
LIGHTS		
Light during a speedcook cycle dims and cycles on and off, even at full power levels	This is normal. Power level has been automatically reduced because the oven is hot.	<ul style="list-style-type: none"> This is normal. The oven senses the heat level and adjusts automatically.
Light visible around the door and outer case while speedcooking	This is normal.	<ul style="list-style-type: none"> When the oven is on, light may be visible around the door and outer case.
COOLING FANS		
Fan continues to run after cooking stops	The oven is cooling.	<ul style="list-style-type: none"> The fans will automatically shut off when the internal parts of the oven have cooled.
Oven vent emits warm air while oven is on	This is normal.	
Fan comes on automatically when using the microwave	This is normal.	
COOKING		
The oven makes unusual sounds while cooking	Clicks are normal. The control is turning the components on and off.	<ul style="list-style-type: none"> These sounds are normal.
	Fan noise is normal. Fans are required to keep the oven components and controls cool.	<ul style="list-style-type: none"> These sounds are normal.
Smoke comes out of the oven when I open the door	Food is high in fat content. Aerosol spray used on the pans.	<ul style="list-style-type: none"> Smoke is normal when cooking high-fat foods.
Food is not fully cooked or browned at the end of a program	Programmed times may not match the size or amount of food you are cooking.	<ul style="list-style-type: none"> Increase or decrease time for doneness or adjust the upper or lower lamps for browning and cooking doneness.
SENSOR ERROR displayed along with an oven signal	Food amount or type placed in the oven does not match the program that was set.	<ul style="list-style-type: none"> Press the CLEAR/OFF pad. Set the oven program to match the food or liquid to be cooked or heated.
	Steam was not sensed by the oven because plastic wrap was not vented, a lid too tight was on the dish or a liquid was covered.	<ul style="list-style-type: none"> Vent plastic wrap, use a looser lid or uncover liquids when cooking or heating.

Questions?
Use this
problem
solver

Problem	Possible Causes	What To Do/Explanation
DISPLAY		
The display is blank	The clock display has been turned off.	<ul style="list-style-type: none"> • Check the OPTIONS menu for clock display settings. Turn the display on.
"Control is LOCKED" appears in display	The control has been locked.	<ul style="list-style-type: none"> • Press and hold CLEAR/OFF for 5 seconds to unlock the control.
Control display is lit but oven will not start	Clock is not set.	<ul style="list-style-type: none"> • Set the clock.
	Door not securely closed.	<ul style="list-style-type: none"> • Open the door and close securely.
	START/PAUSE pad not pressed after entering cooking selection.	<ul style="list-style-type: none"> • Press START/PAUSE.
	Another selection already entered in oven and CLEAR/OFF pad not pressed to cancel it.	<ul style="list-style-type: none"> • Press CLEAR/OFF.
	Size, quantity, or cooking time not entered after final selection.	<ul style="list-style-type: none"> • Make sure you have entered cooking time after selecting.
	CLEAR/OFF was pressed accidentally.	<ul style="list-style-type: none"> • Reset cooking program and press START/PAUSE.
OTHER PROBLEMS		
The door and inside of the oven feels hot	The heat lamps produce intense heat in a small space.	<ul style="list-style-type: none"> • This is normal. • Use oven mitts to remove food when ready.
Oven will not start	A fuse in your home may be blown or the circuit breaker tripped.	<ul style="list-style-type: none"> • Replace fuse or reset circuit breaker.

Consumer Product Ownership Registration

Important Mail Today

GE Appliances



Place
1st Class
Letter
Stamp
Here

General Electric Company
Warranty Registration Department
P.O. Box 32150
Louisville, KY 40232-2150

Consumer Product Ownership Registration

Dear Customer:

Thank you for purchasing our product and thank you for placing your confidence in us. We are proud to have you as a customer!

Follow these three steps to protect your new appliance investment:



1

Complete and mail your Consumer Product Ownership Registration today. Have the peace of mind of knowing we can contact you in the unlikely event of a safety modification.

2

After completing this registration, write your model and serial numbers in this manual. You will need this information should you require service. The service number in the USA: 800.444.1845. In Canada: 1.888.880.3030.

3

Read your Owner's Manual carefully. It will help you operate your new appliance properly.

Important: To ensure that your product is registered, mail the separate product registration card. If the separate product registration card is missing, fold and mail the form below. No envelope is needed.

FOLD HERE

Consumer Product Ownership Registration



Product
Advantium Oven

Model

Serial

Mr. Ms. Mrs. Miss

First Name _____ Last Name _____

Street Address _____

Apt. # _____

City _____ State _____ Zip Code _____

Date Placed In Use
Month _____ Day _____ Year _____ Phone Number _____-_____-_____



ge.com



TAPE CLOSED

With the purchase of your new Monogram appliance, receive the assurance that if you ever need information or assistance from GE, we'll be there. All you have to do is call—toll-free!

GE Answer Center®

**In the USA:
800.626.2000**

Whatever your question about any Monogram major appliance, GE Answer Center® information service is available to help. Your call—and your question—will be answered promptly and courteously. And you can call any time. GE Answer Center® service is open 24 hours a day, Monday through Saturday.

OR

Visit our Website at: monogram.com

In Canada, call 800.561.3344.

**In-Home
Repair Service**

**In the USA:
800.444.1845**

**In Canada:
800.561.3344**

A GE consumer service professional will provide expert repair service, scheduled at a time that's convenient for you. Many GE Consumer Service company-operated locations offer you service today or tomorrow, or at your convenience (7:00 a.m. to 10:00 p.m. weekdays, 8:00 a.m. to 6:00 p.m. Saturday and Sunday). Our factory-trained technicians know your appliance inside and out—so most repairs can be handled in just one visit.

In Canada: Monday to Friday, 7:00 a.m. to 8:00 p.m. and Saturday, 8:00 a.m. to 5:00 p.m. EDST.

**For Customers With
Special Needs...**

**In the USA:
800.626.2000**

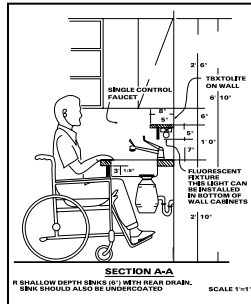

GE offers, free of charge, a brochure to assist in planning a barrier-free kitchen for persons with limited mobility.

Consumers with impaired hearing or speech who have access to a TDD or a conventional teletypewriter may call 800.TDD.GEAC (800.833.4322) to request information or service.

Service Contracts

**In the USA:
800.626.2224**

**In Canada:
800.561.3344**

You can have the secure feeling that GE Consumer Service will still be there after your warranty expires. Purchase a GE contract while your warranty is still in effect and you'll receive a substantial discount. With a multiple-year contract, you're assured of future service at today's prices.

**Parts and
Accessories**

**In the USA:
800.626.2002**

**In Canada:
800.561.3344**

Individuals qualified to service their own appliances can have parts or accessories sent directly to their home. The GE parts system provides access to over 47,000 parts...and all GE Genuine Renewal Parts are fully warranted. VISA, MasterCard and Discover cards are accepted.

User maintenance instructions contained in this manual cover procedures intended to be performed by any user. Other servicing generally should be referred to qualified service personnel. Caution must be exercised, since improper servicing may cause unsafe operation.

YOUR MONOGRAM ADVANTIUM OVEN WARRANTY
Staple sales slip or cancelled check here. Proof of original purchase date is needed to obtain service under warranty.

WHAT IS COVERED

From the Date of the Original Purchase

LIMITED ONE-YEAR WARRANTY

For one year from date of original purchase, we will provide, free of charge, parts and service labor in your home to repair or replace **any part of the oven** that fails because of a manufacturing defect.

LIMITED FIVE-YEAR WARRANTY

For the second through the fifth year from the date of original purchase, we will replace the magnetron tube, if the magnetron fails due to a defect in materials or workmanship. During this additional four-year limited warranty, you will be responsible for any labor or related service costs.

.....
This warranty is extended to the original purchaser and any succeeding owner for products purchased for ordinary home use in the 48 mainland states, Hawaii, Washington, D.C. or Canada. If the product is located in an area where service by a GE Authorized Servicer is not available, you may be responsible for a trip charge or you may be required to bring the product to an Authorized GE Service location for service. In Alaska the warranty is the same except that it is LIMITED because you must pay to ship the product to the service shop or for the service technician's travel costs to your home.

All warranty service will be provided by our Factory Service Centers or by our authorized Customer Care® servicers during normal working hours.

Should your appliance need service, during warranty period or beyond, in the USA call 800.444.1845. In Canada: 800.561.3344. Please have your serial number and model number available when calling for service.

WHAT IS NOT COVERED

- Service trips to your home to teach you how to use the product.
- Improper installation, delivery or maintenance.
If you have an installation problem, contact your dealer or installer. You are responsible for providing adequate electrical, gas, exhausting and other connecting facilities as described in the Installation Instructions provided with the product.
- Replacement of house fuses or resetting of circuit breakers.
- Damage to the product due to misuse or abuse.
- Failure of the product if it is used for other than its intended purpose or used commercially.
- Damage to product caused by accident, fire, floods or acts of God.
- Incidental or consequential damage caused by possible defects with this appliance.
- Damage caused after delivery.
- Product not accessible to provide required service.

EXCLUSION OF IMPLIED WARRANTIES—Your sole and exclusive remedy is product repair as provided in this Limited Warranty. Any implied warranties, including the implied warranties of merchantability or fitness for a particular purpose, are limited to one year or the shortest period allowed by law.

Some states do not allow the exclusion or limitation of incidental or consequential damages, so the above limitation or exclusion may not apply to you. This warranty gives you specific legal rights, and you may also have other rights which vary from state to state. To know what your legal rights are in your state, consult your local or state consumer affairs office or your state's Attorney General.

Warrantor: General Electric Company, Louisville, KY 40225



GE Consumer & Industrial
Appliances
General Electric Company
Louisville, KY 40225
monogram.com