

Owner's Manual

Automatic
Icemaker

ZDIC150
ZDIS150



Consumer Information

Icemaker

Contents

Care and Cleaning	11-13	Problem Solver	14
Consumer Services	15	Product Registration	2
Controls and Features	8, 9	Repair Service	3
Important Phone Numbers	15	Safety Instructions	4-7
Model and Serial Numbers	2	Warranty	Back Cover
Operating Instructions	10		

Before using your icemaker

Read this manual carefully. It is intended to help you operate and maintain your new icemaker properly.

Keep it handy for answers to your questions.

If you don't understand something or need more help, there is a list of toll-free consumer service numbers included in the back section of this manual.

OR

Visit our Website at: **monogram.com**

Write down the model & serial numbers

You'll find them on a label on the right wall of the ice storage bin.

These numbers are also on the Consumer Product Ownership Registration Card packed separately with your icemaker.

Before sending in this card, please write these numbers here:

Model Number

Serial Number

Use these numbers in any correspondence or service calls concerning your icemaker.

*If you
received a
damaged
icemaker*

Immediately contact the dealer (or builder) that sold you the icemaker.

*If you
need
service*

To obtain service, see the Consumer Services page in the back of this manual.

We're proud of our service and want you to be pleased. If for some reason you are not happy with the service you receive, follow these steps.

For customers in the USA:

FIRST, contact the people who serviced your appliance. Explain why you are not pleased. In most cases, this will solve the problem.

NEXT, if you are still not pleased, write all the details—including your phone number—to:

Manager, Customer Relations
GE Appliances
Appliance Park
Louisville, KY 40225

For customers in Canada:

FIRST, contact the people who serviced your appliance. Explain why you are not pleased. In most cases, this will solve the problem.

NEXT, if you are still not pleased, write all the details—including your phone number—to:

Manager, Customer Relations
Mabe Canada Inc.
1 Factory Lane, Suite 310
Moncton, N.B. E1C 9M3

IMPORTANT SAFETY INSTRUCTIONS

READ AND SAVE THESE INSTRUCTIONS

Before it is used, the icemaker must be properly installed and located as described in this manual.

⚠ WARNING: To reduce the risk of fire, electrical shock or injury when using your icemaker, follow basic precautions including the following:

- Never allow children to operate, play with or crawl inside the icemaker.
 - Never clean icemaker parts with flammable fluids. The fumes can create a fire hazard or explosion.
 - Do not store or use gasoline or other flammable vapors and liquids in the vicinity of this or any other appliance. The fumes can create a fire hazard or explosion.
 - Be sure your icemaker is properly installed and grounded by a qualified technician in accordance with the Installation Instructions.
 - Do not attempt to repair or replace any part of your icemaker unless it is specifically recommended in this manual. All other servicing should be referred to a qualified technician.
- Unplug the icemaker or disconnect power before cleaning, servicing or changing the light bulb. Failure to do so can result in death or electrical shock.
 - It is your responsibility to be sure your icemaker:
 - has been installed where it is protected from the elements.
 - is located so that the front is not blocked to restrict incoming or discharge air flow.
 - is connected only to the proper kind of outlet, with the correct electric supply and grounding. A 115 volt, 60 Hz., 15 amp fused electrical supply is required.

NOTE: Time delay fuse or circuit breaker is recommended.

- is not used by anyone unable to operate it properly.
- is used only to do what icemakers are designed to do.
- is properly maintained.

IMPORTANTES INSTRUCTIONS DE SÉCURITÉ

LIRE ET CONSERVER CES INSTRUCTIONS

Avant son utilisation, la machine à glaçons doit être bien installée et située selon la description dans ce manuel.

⚠ AVERTISSEMENT : Pour réduire les risques d'incendie, de choc électrique ou de blessure lors de l'utilisation de la machine à glaçons, suivre les précautions fondamentales, y compris les suivantes :

- Ne jamais laisser les enfants utiliser, employer comme jouet ou pénétrer dans la machine à glaçons.
- Ne jamais nettoyer les pièces de la machine à glaçons avec des fluides inflammables. Les émanations peuvent créer un risque d'incendie ou d'explosion.
- Ne pas entreposer ni utiliser de l'essence ou d'autres vapeurs et liquides inflammables dans le voisinage de cet appareil ménager ou de tout autre appareil. Les émanations peuvent créer un risque d'incendie ou d'explosion.
- S'assurer que la machine à glaçons est bien installée et reliée à la terre par un technicien qualifié, et conformément aux instructions d'installation.
- Ne pas essayer de réparer ou de remplacer une pièce de votre machine à glaçons à moins de recommandations spécifiques dans ce manuel. Tout autre besoin de service doit être soumis à un technicien qualifié.
- Débrancher la machine à glaçons ou déconnecter le courant électrique avant de la nettoyer, de l'entretenir ou de changer l'ampoule d'éclairage. L'omission d'observer ces précautions peut causer un décès ou un choc électrique.
- Vous avez la responsabilité de vous assurer que la machine à glaçons :
 - a été installée où elle est protégée contre les intempéries.
 - est située de sorte que le devant n'est pas obstruée pour restreindre l'arrivée ou la sortie du courant d'air.
 - est connectée seulement au type approprié de prise de courant avec une alimentation électrique correcte et une liaison à la terre. Une alimentation électrique de 115 V, 60 Hz, et fusible de 15 A est requise.

REMARQUE : Les fusibles temporisés ou disjoncteurs de circuit sont recommandés.

- n'est pas utilisée par quiconque ne peut faire fonctionner l'appareil d'une manière appropriée.
- est utilisée seulement pour accomplir ce que les machines à glaçons sont destinées à fournir.
- est soumise à un entretien approprié.

⚠ WARNING! Failure to follow these instructions can result in death, fire, or electrical shock.

⚠ AVERTISSEMENT ! Le non-respect de ces instructions peut causer la mort, un incendie ou un choc électrique.

HOW TO CONNECT ELECTRICITY

Do not, under any circumstances, cut or remove the third (ground) prong from the power cord. For personal safety, this appliance must be properly grounded.

The power cord of this appliance is equipped with a 3-prong (grounding) plug which mates with a standard 3-prong (grounding) wall outlet to minimize the possibility of electric shock hazard from this appliance.

Have the wall outlet and circuit checked by a qualified electrician to make sure the outlet is properly grounded.

Where a standard 2-prong wall outlet is encountered, it is your personal responsibility and obligation to have it replaced with a properly grounded 3-prong wall outlet.

The icemaker should always be plugged into its own individual electrical outlet which has a voltage rating that matches the rating plate. This provides the best performance and also prevents overloading house wiring circuits which could cause a fire hazard from overheated wires.

Never unplug your icemaker by pulling on the power cord. Always grip plug firmly and pull straight out from the outlet.

Repair or replace immediately all power cords that have become frayed or otherwise damaged. Do not use a cord that shows cracks or abrasion damage along its length or at either end.

When moving the icemaker, be careful not to roll over or damage the power cord.

RACCORDEMENT ÉLECTRIQUE

Ne coupez ni retirez en aucun cas la troisième broche (mise à la terre) de la fiche du cordon d'alimentation. Pour votre sécurité, cet appareil doit être correctement mis à la terre.

Le cordon d'alimentation de cet appareil est muni d'une fiche à 3 broches (mise à la terre) qui se branche dans une prise mural ordinaire à 3 alvéoles (mise à la terre) pour réduire au minimum les risques du chocs électriques.

Faites examiner la prise de courant et le circuit par un électricien qualifié pour vous assurer que la prise est correctement mise à la terre.

Si la prise murale est du type standard à 2 alvéoles, il vous incombe de la faire remplacer par une prise à 3 alvéoles correctement mise à la terre.

La machine à glaçons doit toujours être branché dans sa propre prise de courant, dont la tension nominale est identique à celle indiquée sur la plaque signalétique.

Cette précaution est recommandée pour garantir un rendement optimum et éviter une surcharge des circuits électriques de la résidence, ce qui pourrait créer un risque d'incendie par surschauffe des fils.

Ne débranchez jamais la machine à glaçons en tirant le cordon d'alimentation. Saisissez fermement la fiche du cordon et tirez droit pour la retirer de la prise.

Réparez ou remplacez immédiatement tout cordon effiloché ou endommagé. N'utilisez pas un cordon fendillé ou présentant des signes d'usure.

Lorsque vous déplacez votre machine à glaçons du mur, faites attention de ne pas la faire rouler sur le cordon d'alimentation afin de ne pas l'endommager.

EXTENSION CORDS

Do not use an extension cord with this appliance.

RALLONGES

N'utilisez pas de rallonge avec cet appareil.

⚠ DANGER: RISK OF CHILD ENTRAPMENT

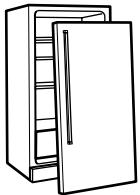

Child entrapment and suffocation are not problems of the past. Junked or abandoned refrigeration products are still dangerous... even if they will sit for "just a few days." If you are getting rid of your old appliance, please follow these instructions to help prevent accidents.

Before You Throw Away Your Old Refrigeration Product:

- Take off the doors.
- Leave the shelves in place so that children may not easily climb inside.

⚠ DANGER! RISQUES POUR LES ENFANTS

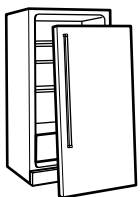

Les enfants pris au piège ou morts d'asphyxie sont toujours d'actualité. Les appareils de réfrigération abandonnés sont toujours aussi dangereux, même si on n'attend que "quelque jours" pour s'en débarrasser. Si vous ne gardez pas votre ancien appareil, veuillez suivre les directives ci-dessous afin de prévenir les accidents.

Avant de vous débarrasser de votre vieux appareil de réfrigération :

- Démontez les portes.
- Laissez les clayettes en place afin d'empêcher les enfants de grimper à l'intérieur.

REFRIGERANTS

All refrigeration products contain refrigerants, which under federal law must be removed prior to product disposal. If you are getting rid of an old refrigeration product, check with the company handling the disposal about what to do.

RÉFRIGÉRANTS

Tous les appareils de réfrigération contiennent des réfrigérants qui, conformément aux lois fédérales, doivent être enlevés avant toute élimination de l'appareil. Si vous vous débarrassez de vieux appareils de réfrigération, vérifiez, auprès de la société qui s'occupe de leur élimination, ce que vous devez faire.

Remove packaging

IMPORTANT: Do not remove any permanent instruction labels inside your icemaker or the Tech Sheet that is fastened behind the lower access panel.

- Remove tape and any labels from your icemaker before using (except the model and serial number label).

To remove any remaining tape or glue, rub the area briskly with your thumb. Tape or glue residue can also be easily removed by rubbing a small amount of liquid dish soap over the adhesive with your fingers. Wipe with warm water and dry.

- Do not use sharp instruments, rubbing alcohol, flammable fluids or abrasive cleaners to remove tape or glue. These products can damage the surface of your icemaker. For more information, see *Important Safety Instructions*.

Clean before using

After you remove all of the packaging materials, clean the inside of your icemaker before using it.

See the cleaning instructions in *Care and Cleaning*.

Set controls

1. To start the normal ice making cycle, select ON.
2. To stop icemaker operation, press and hold OFF.

NOTE: The CLEAN setting is used whenever solutions are circulated through the icemaker for cleaning. See *Care and Cleaning*.

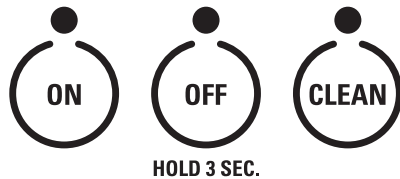

Features of your icemaker

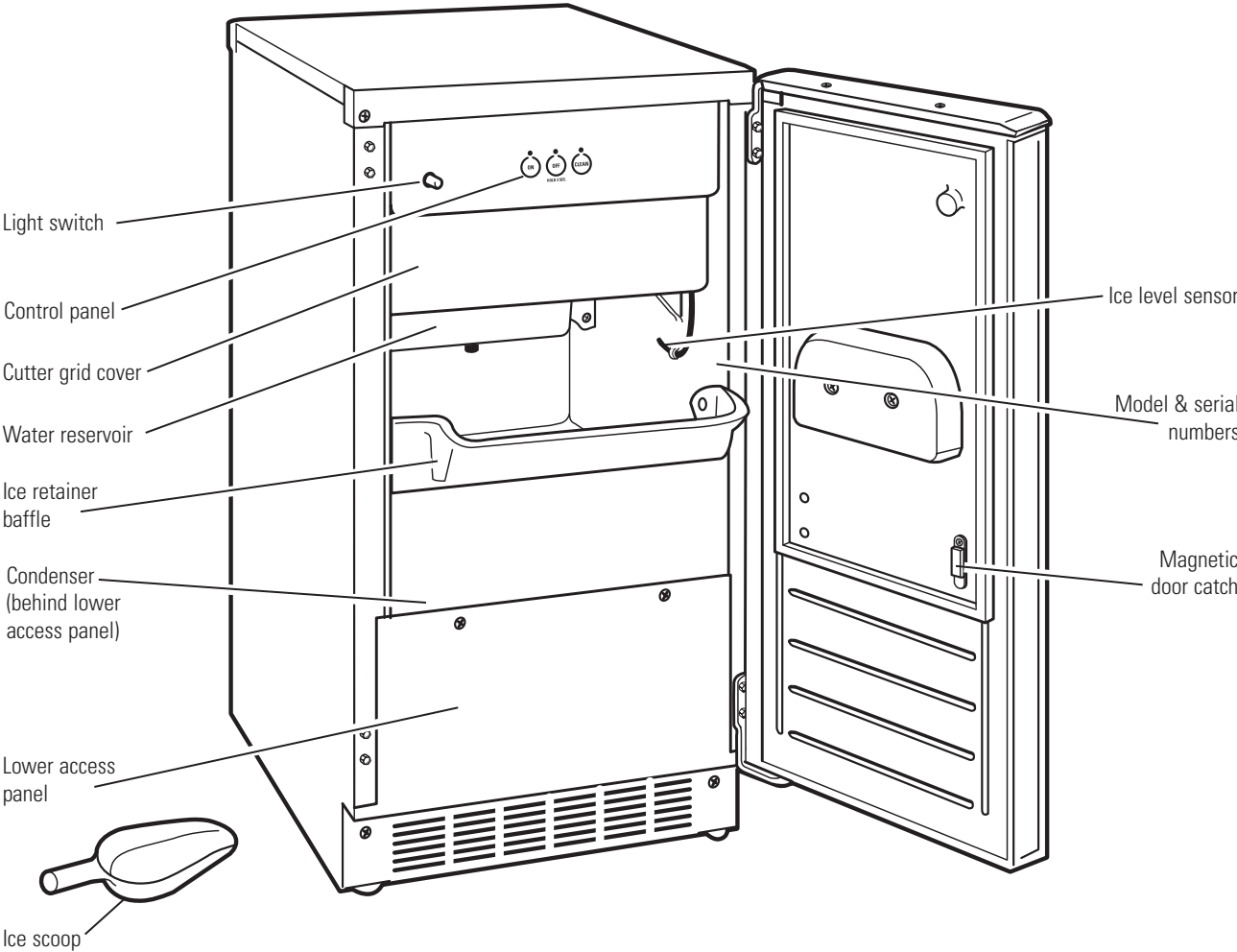

How your icemaker works

When you first start your icemaker, the water reservoir will fill and the system will rinse itself before starting to make ice. The rinsing process takes about five minutes.

Under normal operating conditions, the icemaker will cycle on and off as needed. The ice level sensor located in the ice storage bin will monitor the ice levels.

IMPORTANT

- If the water supply to the icemaker is turned off, be sure to set the icemaker control to OFF. Drain the water reservoir and leave the icemaker door open to allow it to dry completely.
- The icemaker is designed to make clear ice from the majority of water sources on a daily basis. If your results are unsatisfactory, your water may need to be filtered or treated.

Making Ice

1. Water is constantly circulated over a freezing plate. As the water freezes into ice, the minerals in the water are rejected. This produces a clear sheet of ice with a low mineral content.

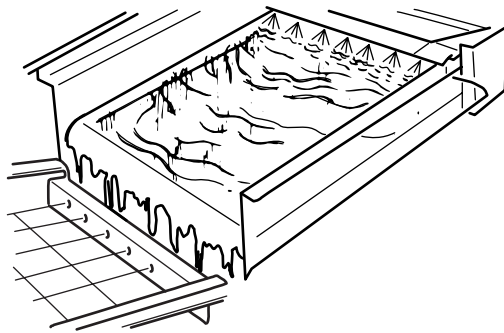

2. When the desired thickness is reached, the ice sheet is released and slides onto a cutter grid. The grid divides the sheet into individual cubes.

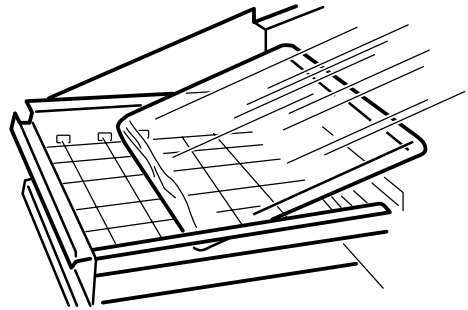

3. The water containing the rejected minerals is drained after each freezing cycle.
4. Fresh water enters the machine for the next ice making cycle.
5. Cubes fall into the storage bin. When the bin is full, the icemaker shuts off automatically and restarts when more ice is needed. The ice bin is not refrigerated and some melting will occur. The amount of melting varies with room temperature.

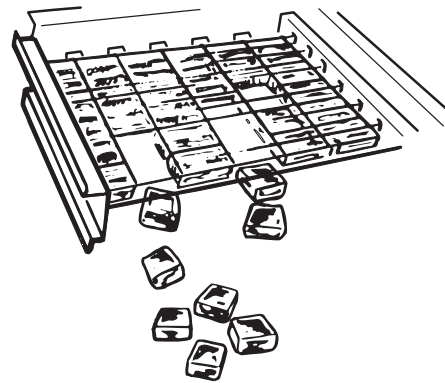

NOTE: As the room and water temperatures vary, so will the amount of ice produced and stored. This means that higher operating temperatures result in reduced ice production.

Caring for your icemaker

The clean light signal will illuminate yellow when the electronic control senses that the need for cleaning is approaching. At this time you need to purchase Nickel Safe Ice Machine Cleaner by Nu Calgon, available at most appliance repair shops or through GE Parts and Accessories. Order part number WX08X42870. In the U.S.A., call 1-800-626-2002 or visit Monogram.com. In Canada call 1-800-561-3344. The clean light will eventually turn red which means the icemaker must be cleaned, otherwise ice production will decrease significantly or stop altogether.

IMPORTANT: For best results, use the entire contents of the bottle to clean the unit. See *Care and Cleaning—Icemaker system* section.

The air cooled condenser (see page 9 for location) needs to be cleaned regularly for efficient ice production and energy conservation.

See *Care and Cleaning - Condenser* section.

Exterior surfaces

Door handles and trim—Clean with a cloth dampened with soapy water. Dry with a soft cloth.

Keep the outside clean. Wipe with a clean cloth lightly dampened with mild liquid dish detergent. Dry with a clean, soft cloth. Do not wipe the icemaker with a soiled dish cloth or wet towel. These may leave a residue that can damage the finish. Do not use scouring pads, powdered cleaners, bleach or cleaners containing bleach because these products can scratch and damage the finish.

Stainless steel—Regularly clean and polish the stainless steel door panels and handles (on some models) with a commercially available stainless steel cleaner such as *Stainless Steel Magic™* to preserve and protect the fine finish. *Stainless Steel Magic* is available through GE Parts and Accessories, 800.626.2002, or monogram.com. Order part number WX10X15.

Do not use appliance wax or polish on the stainless steel.

Icemaker system

1. Press and hold the OFF button for 3 seconds.
2. Wait 5 to 10 minutes for the ice to fall into the storage bin. Remove all ice from the storage bin.
3. Unscrew the drain cap from the bottom of the water reservoir located inside the storage bin as shown. Allow the water to drain completely.

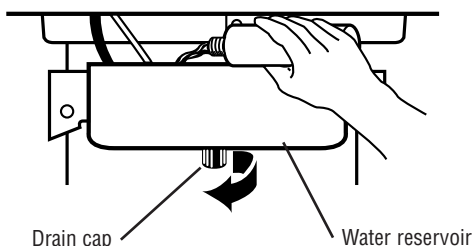

4. Replace the drain cap.
5. For best results, use the entire 16 oz. bottle of Nickel Safe Ice Machine Cleaner. Follow all safety precautions on the bottle. Pour one bottle of solution into the water reservoir. Fill the bottle twice with tap water and pour it into the water reservoir.

Nickel Safe Ice Machine Cleaner by Nu Calgon is available at appliance repair shops, or through GE Parts and Accessories. Order part number WX08X42870. In the U.S.A., call 800.626.2002 or visit monogram.com. In Canada, call 1.800.561.3344.

6. Press and hold the CLEAN button for 3

seconds. The CLEAN light will begin to blink, indicating that the cleaning cycle is in process. The cleaning time is approximately 70 minutes.

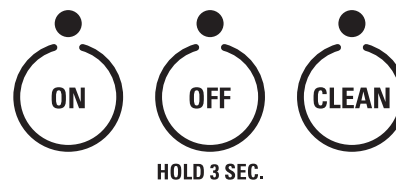

7. When the indicator light becomes solid and remains lit, the cleaning cycle is complete. During the cleaning cycle, the system will both clean and rinse itself.
8. After the cleaning cycle is complete, remove the drain cap from the water reservoir to see if any cleaning solution, green in color, is left in the water reservoir. If cleaning solution drains from the water reservoir, you should run the clean cycle again adding only tap water to the reservoir. Be sure to replace the drain cap before running the cycle again. If the cap is not securely tightened, water can leak, causing thin ice or no ice.

NOTE: Severe scale buildup may require repeated cleaning with a fresh quantity of cleaning solution.

9. Press the ON button for 3 seconds to resume ice production.

Condenser

For best performance, brush or vacuum lint and dirt from the condenser at least once a year.

A dirty or clogged condenser:

- Use more energy..
- Prevents proper airflow.
- Reduces ice making capacity.
- Causes higher than recommended operating temperatures which may lead to component failure.

1. Unplug the icemaker or disconnect power.
2. Remove the 2 screws in the lower access panel and the 2 screws from the base grille area of the front panel support. Pull forward to remove the lower access panel.
3. Pull the bottom forward and then pull down to remove the lower access panel.

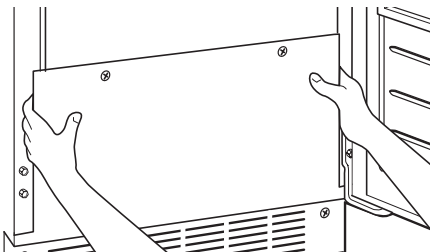

4. Remove dirt and lint from the condenser fins and the unit compartment with a brush attachment attached to a vacuum cleaner.

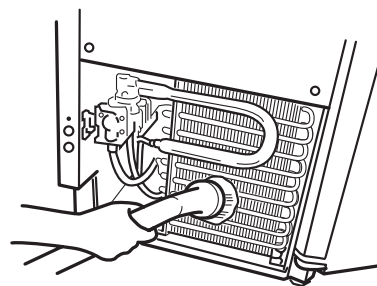

5. Replace the lower access panel using the 4 screws.
6. Plug in the icemaker or reconnect power.

Light bulb replacement

The icemaker has a light bulb in the top of the storage bin. To replace it, open the bin door and follow these instructions:

1. Unplug the icemaker or disconnect power.
2. Remove the 2 screws that hold the cutter grid cover in place. Reach behind the control panel and pull the light bulb down.
3. Replace with a 12-volt wedge base-type bulb (automotive #917). Locate the light bulb receptacle at the top behind the control panel. Align the flat edge of the light bulb with the receptacle and snap the bulb into place.
4. Replace the cutter grid cover with the 2 screws.

5. Plug in the icemaker or reconnect power.

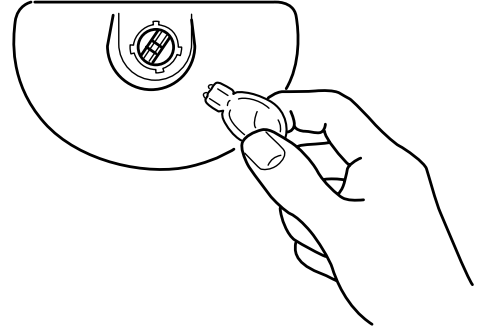

Vacation and moving

To shut down the icemaker:

1. Unplug the icemaker or disconnect power.
2. Remove all ice from the storage bin.
3. Shut off the water supply.
4. Before using again, clean the icemaker and storage bin.
5. Plug in the icemaker or reconnect power.

Reverse Osmosis system

IMPORTANT: The performance of the icemaker may be affected when connected to a Reverse Osmosis system. An RO system may also reduce water pressure and affect the fill cycle, which is dependent on time and flow. The reduced water pressure may cause the reservoir not to fill and flush properly during the ice making cycle.

The pressure of the water supply coming out of a reverse osmosis system going to the water inlet valve of the icemaker needs to be between 30 and 120 psi.

If a reverse osmosis water filtration system is connected to your cold water supply, the water pressure to the reverse osmosis system needs to be a minimum of 40 psi. The reverse osmosis system must provide 1 gal. of water per hour to the icemaker for proper icemaker operation.

Do not use copper tubing when the icemaker is connected to a Reverse Osmosis water system.

The Problem Solver

Icemaker

Questions?

Use this
problem
solver!

PROBLEM	POSSIBLE CAUSE
CLEAN INDICATOR LIGHT ON CONTROL PANEL IS YELLOW	<ul style="list-style-type: none"> It will soon be time to clean the icemaker. You will need WX08X42870 Nickel Safe Ice Machine Cleaner to clean the icemaker. See <i>Care and Cleaning—Care for your Icemaker</i>.
CLEAN INDICATOR LIGHT ON CONTROL PANEL IS RED	<ul style="list-style-type: none"> It is time to clean the icemaker. See <i>Care and Cleaning—Icemaker System</i> section.
ICEMAKER DOES NOT OPERATE	<ul style="list-style-type: none"> Power cord is not plugged into a live outlet. The control is set at OFF. The fuse is blown/circuit breaker is tripped. Replace fuse or reset the breaker. ZPK1 Auxiliary Kit fault. Drain line kinked or blocked.
ICE CUBES HAVE ODOR/TASTE	<ul style="list-style-type: none"> High mineral content in the water supply. Water may need to be filtered or treated. Food items stored in ice bin. Do not store any foods in the ice bin. Packaging materials were not removed. Make sure that all packaging materials were removed at the time of installation. Ice storage bin needs cleaning. Scale has built up in the icemaker. If there is white scale buildup in the icemaker's water or freezing system, you should clean the icemaker. See <i>Care and Cleaning—Icemaker System</i>.
ICEMAKER IS ON, BUT DOESN'T PRODUCE ICE	<ul style="list-style-type: none"> The control is set at OFF. Water supply is turned off or not connected. Condenser is dirty. Dirt or lint may be blocking the airflow through the condenser. See <i>Care and Cleaning—Condenser</i>. Scale has built up in the icemaker. If there is white scale buildup in the icemaker's water or freezing system, you should clean the icemaker. See <i>Care and Cleaning—Icemaker System</i>. Check for a kink in the drain hose from the ZPK1 Drain Pump Kit to the house drain. Water supply has been interrupted. Have a plumber check for a clogged water valve. Room temperature is colder than normal. Room temperature must be above 55°F (13°C). Otherwise, bin thermostat may sense cold room temperature and shut off even though the bin is not full of ice. Also, unit may not restart once it does shut off.
ICEMAKER IS ON, BUT PRODUCES LITTLE OR NO ICE	<ul style="list-style-type: none"> Condenser is dirty. Dirt or lint may be blocking the airflow through the condenser. See <i>Care and Cleaning—Condenser</i>. Scale has built up in the icemaker. If there is white scale buildup in the icemaker's water or freezing system, you should clean the icemaker. See <i>Care and Cleaning—Icemaker System</i>. Water is leaking from the water reservoir because the drain cap is not secure. Make sure the drain cap is securely tightened. Refer to illustration in <i>Care and Cleaning—Icemaker System</i> section. Room temperature is too hot. Room temperatures of more than 90°F (32°C) will reduce ice production.
ICEMAKER PUMPS CONTINUOUSLY, BUT PRODUCES NO ICE	<ul style="list-style-type: none"> The ice sheet is trapped on the cutter grid. Shut off the icemaker for at least one hour to allow the ice sheet to melt. Turn the icemaker back on. The icemaker will reset itself and start a new cycle after flushing water through the system. NOTE: Follow the directions in the <i>Care and Cleaning—Icemaker System</i> section to clean with the Nickel Safe Ice Machine Cleaner.
ICE IS THIN, SOFT OR CLUMPED	<ul style="list-style-type: none"> High mineral content in the water supply. Water may need to be filtered or treated. Scale has built up in the icemaker. Clean your icemaker. See <i>Care and Cleaning—Icemaker System</i> section. The ice bin is not refrigerated, so ice not regularly used will melt and form clumps. Break the clumps with the ice scoop provided.
ICEMAKER SOUNDS	<ul style="list-style-type: none"> After an ice-making cycle, you may hear ice cubes dropping into the storage bin. Water is circulated by a pump through the icemaker during the entire ice making cycle. Water is added once per ice-making cycle. The compressor may cause a clicking or chirping sound when attempting to restart. The flow of refrigerant through the refrigerating system may make a gurgling sound like boiling water. A "whooshing" sound may indicate the water supply is not connected properly, the water supply is turned off or the drain cap is loose.

With the purchase of your new Monogram appliance, receive the assurance that if you ever need information or assistance from GE, we'll be there. All you have to do is call!

GE Answer Center®

**In the USA:
800.626.2000**

Whatever your question about any Monogram major appliance, GE Answer Center® information service is available to help. Your call—and your question—will be answered promptly and courteously. And you can call any time. GE Answer Center® service is open 24 hours a day, Monday through Saturday.

OR

Visit our Website at: monogram.com

In Canada, call 1.800.561.3344.

In-Home Repair Service

**In the USA:
800.444.1845**

If your Monogram appliance should ever require service, you can depend on Monogram Preferred Service. Simply call 800.444.1845, where our Monogram Preferred Service Specialists are available 7 a.m. - 10 p.m. ET Monday through Friday and 8 a.m. - 6 p.m. ET Saturday and Sunday to coordinate your service appointment. In Canada: Monday to Friday, 7:00 a.m. to 8:00 p.m. and Saturday, 8:00 a.m. to 5:00 p.m. EDST.

**In Canada:
1.800.561.3344**

For Customers With Special Needs...

**In the USA:
800.626.2000**

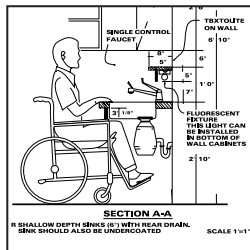

GE offers Braille controls for a variety of GE appliances, and a brochure to assist in planning a barrier-free kitchen for persons with limited mobility.

Consumers with impaired hearing or speech who have access to a TDD or a conventional teletypewriter may call 800.TDD.GEAC (800.833.4322) to request information or service.

Service Contracts

**In the USA:
800.626.2224**

You can have the secure feeling that GE Consumer Service will still be there after your warranty expires. Purchase a GE contract while your warranty is still in effect and you'll receive a substantial discount. With a multiple-year contract, you're assured of future service at today's prices.

**In Canada:
1.800.561.3344**

Parts and Accessories

**In the USA:
800.626.2002**

Individuals qualified to service their own appliances can have parts or accessories sent directly to their home. The GE parts system provides access to over 47,000 parts...and all GE Genuine Renewal Parts are fully warranted. VISA, MasterCard and Discover cards are accepted. Visit www.geappliances.com

**In Canada:
1.800.561.3344**

User maintenance instructions contained in this manual cover procedures intended to be performed by any user. Other servicing generally should be referred to qualified service personnel. Caution must be exercised, since improper servicing may cause unsafe operation.

YOUR MONOGRAM ICEMAKER WARRANTY

Staple sales slip or cancelled check here. Proof of original purchase date is needed to obtain service under warranty.

WHAT IS COVERED

From the Date of the Original Purchase

LIMITED ONE-YEAR WARRANTY

For one year from date of original purchase, we will provide, free of charge, parts and service labor in your home to repair or replace *any part of the icemaker* that fails because of a manufacturing defect.

LIMITED FIVE-YEAR WARRANTY

For five years from date of original purchase, we will provide, free of charge, parts and service labor in your home to repair or replace *any part of the sealed icemaking system* (the compressor, condenser, evaporator and all connecting tubing) that fails because of a manufacturing defect.

This warranty is extended to the original purchaser and any succeeding owner for products purchased for ordinary home use in the 48 mainland states, Hawaii, Washington, D.C. or Canada. If the product is located in an area where service by a GE Authorized Servicer is not available, you may be responsible for a trip charge or you may be required to bring the product to an Authorized GE Service location for service. In Alaska the warranty is the same except that it is LIMITED because you must pay to ship the product to the service shop or for the service technician's travel costs to your home.

All warranty service will be provided by our Factory Service Centers or by our authorized Customer Care® servicers during normal working hours.

Should your appliance need service, during warranty period or beyond, in the USA call 800.444.1845. In Canada: 800.561.3344. Please have your serial number and model number available when calling for service.

WHAT IS NOT COVERED

- Service trips to your home to teach you how to use the product.
- Replacement of house fuses or resetting of circuit breakers.
- Damage to the product caused by accident, fire, floods or acts of God.
- Failure of the product if it is used for other than its intended purpose or used commercially.
- Damage caused after delivery.
- Improper installation, delivery or maintenance. If you have an installation problem, contact your dealer or installer. You are responsible for providing adequate electrical, plumbing and other connecting facilities.
- Replacement of the light bulbs, if included.
- Incidental or consequential damage caused by possible defects with this appliance.
- Product not accessible to provide required service.

EXCLUSION OF IMPLIED WARRANTIES—Your sole and exclusive remedy is product repair as provided in this Limited Warranty. Any implied warranties, including the implied warranties of merchantability or fitness for a particular purpose, are limited to one year or the shortest period allowed by law.

Some states/provinces do not allow the exclusion or limitation of incidental or consequential damages, so the above limitation or exclusion may not apply to you. This warranty gives you specific legal rights, and you may also have other rights which vary from state to state/province to province. To know what your legal rights are in your state/province, consult your local or state/provincial consumer affairs office or your state's Attorney General.

**Warrantor in USA: General Electric Company,
Louisville, KY 40225**

Warrantor in Canada: Mabe Canada Inc.

2313686C

224D1893P002

49-60508-3

04-08 JR

Printed in the United States



GE Consumer & Industrial
Appliances
General Electric Company
Louisville, KY 40225
ge.com