

PVB94SN

GE Profile™ 30" Telescopic Downdraft System

Dimensions and Installation Information (in inches)

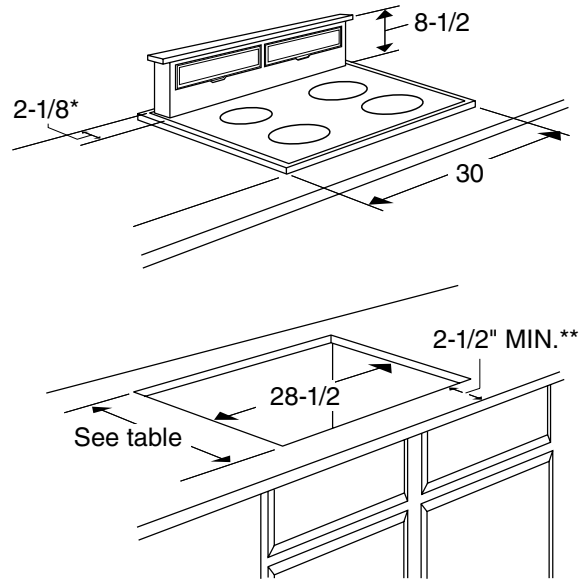

Venting Options (in inches)

Through the Floor

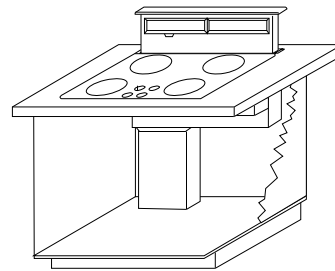

In Cabinet Discharge (Down)

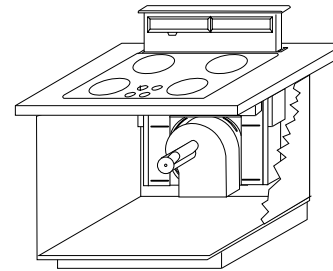

In Cabinet Discharge (Right)

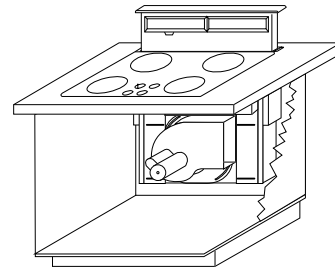

In Cabinet Discharge (Left)

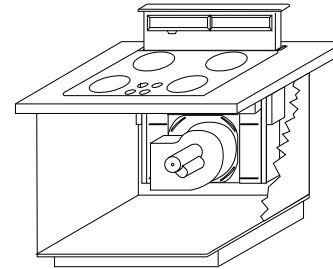

Note: Telescopic downdraft vents are not recommended to be installed with cooktops that are flush mounted.

Approved for use with the following GE Profile Performance™, GE Profile™, and GE cooktops—36" and 30" electric models, 36" and 30" gas sealed burner models and 36" and 30" induction models.

Not Approved for use with standard burner gas cooktops.

Note: The cooktop must be at least 26" deep with a flat surface area of 23-1/2" or more, front to back. In addition, other clearances to the front edge of the countertop must be considered.

Note: Dimensions shown are for reference only. Before cutting out countertop, refer to instructions packed with **downdraft and cooktop.**

Note: Installation on cabinets/countertops against the wall will not be possible in most applications. Against the wall installations are limited to dimension requirements. Refer to installation instructions packed with product for further details.

JXBC67 Outdoor Cover. Optional accessory may be ordered for installation of motor and blower assembly on outside wall.

JXRB67 Indoor Remote Accessory. Optional accessory may be ordered for installation of motor and blower assembly in an indoor remote location.

For answers to your Monogram®, GE Profile™ or GE® appliance questions, visit our website at ge.com or call GE Answer Center® service, 800.626.2000.













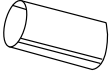



imagination at work

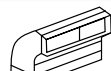

PVB94SN

GE Profile™ 30" Telescopic Downdraft System

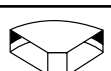
Venting Duct Information

Duct Pieces	Equivalent Length*	Duct Pieces	Equivalent Length*
 6" Round Straight	1 ft. (per foot length)	 3-1/4" x 10" to 6" Round Transition	5 ft.
 3-1/4" x 10" Straight	1 ft. (per foot length)	 6" Round to 3-1/4" x 10" Transitions 90° Elbow	20 ft.
 6" 90° Elbow	15 ft.	 3-1/4" x 10" to 6" Round Transition 90° Elbow	12 ft.
 6" 45° Elbow	9 ft.	 6" Round Wall Cap with Damper	21 ft.
 3-1/4" x 10" 90° Elbow	16 ft.	 3-1/4" x 10" Wall Cap with Damper	27 ft.
 3-1/4" x 10" 45° Elbow	5 ft.	 6" Round Roof Cap	20 ft.
 3-1/4" x 10" 45° Elbow	24 ft.	 6" Round Roof Vent	24 ft.
 6" Round to 3-1/4" x 10" Transitions	7 ft.	SHOULD NOT EXCEED 100 EQUIVALENT FT. *Equivalent length of duct pieces are based on actual test conducted by GE Evaluation Engineering and reflect requirements for good venting performance with a downdraft rated at 500 CFM	

For answers to your Monogram®, GE Profile™ or GE® appliance questions, visit our website at ge.com or call GE Answer Center® service, 800.626.2000.



Plan the Ductwork

1. This downdraft blower system is designed for use with 3-1/4" x 10" ductwork (can be transitioned to 6" round). Two different discharge directions are available with side-to-side adjustment for the accurate alignment of ductwork.
2. For best performance: choose the ducting option which allows the shortest length of ductwork and a minimum number of elbows and transitions. Check location of floor joists, wall joists, wall studs, electrical wiring or plumbing for possible interference.

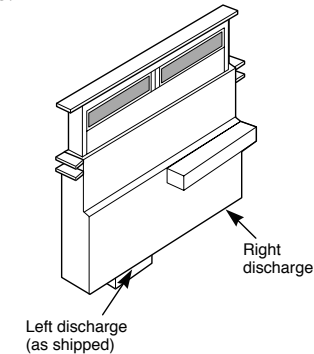

Steps to Determine Flexible Ducting's Equivalent Length

1. Measure the actual amount of offset (Maximum 3" recommended). The effect upon airflow is dependent upon the amount of offset.
 2. Calculate the equivalent ducting allowances using:

$$(\text{__ in. offset}) \times (14 \text{ Ft. per inch}) = \text{__ Ft. equivalent length.}$$
1. Ensure that the total equivalent length of ducting does not exceed the maximum recommendation of 150 feet.



PVB94SN

GE Profile™ 30" Telescopic Downdraft System

Features and Benefits

- Telescopic Downdraft Hood - Hood raises over cooktop surface and retracts when not in use
- 500 CFM - Powerful 500 CFM performance removes smoke and vapors from the cooking area
- Variable Speed Fan Control - The powerful variable speed exhaust system effectively pulls smoke and vapors out of the kitchen
- Removable grease filter - Durable filters can be removed for easy cleaning and maintenance
- Model PVB94SNSS – White on white

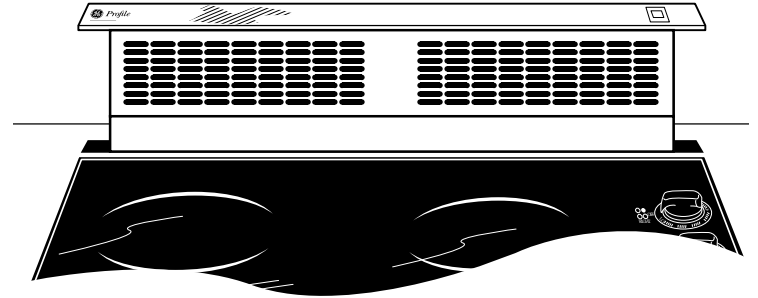

For answers to your Monogram®, GE Profile™ or GE® appliance questions, visit our website at ge.com or call GE Answer Center® service, 800.626.2000.

