

GE Monogram[®]

Installation

Instructions

36" Electric
Radiant Cooktop
Model
ZEU36R

Before you begin—Read these instructions completely and carefully.

IMPORTANT—Save these instructions for local inspector's use.

IMPORTANT—**OBSERVE ALL GOVERNING CODES AND ORDINANCES.**

Note to Installer—Be sure to leave these instructions with the Consumer.

Note to Consumer—Keep these instructions for future reference.

Note—This appliance must be properly grounded.

ATTENTION INSTALLER: ALL COOKTOPS MUST BE HARD WIRED (DIRECT WIRED) INTO AN APPROVED JUNCTION BOX. A "PLUG AND RECEPTACLE" IS NOT PERMITTED ON THESE PRODUCTS.



WARNING

This appliance must be properly grounded. See "Electrical Connections," page 7.

If you have questions concerning the installation of this product, call the GE Answer Center® Consumer Information Service at 800.626.2000, 24 hours a day, 7 days a week or visit our website at: Monogram.com.

If you received a damaged cooktop, you should contact your dealer.

Proper installation is the responsibility of the installer. Product failure due to improper installation is not covered under the GE Appliance Warranty. See the Owner's Manual for warranty information.

For Monogram local service in your area,

1.800.444.1845.

For Monogram Service in Canada,

1.888.880.3030.

For Monogram Parts and Accessories,
call 1.800.626.2002.

FOR YOUR SAFETY:

- For Personal Safety, remove house fuse or open circuit breaker before beginning installation. Failure to do so could result in serious injury or death.
 - Be sure your cooktop is installed properly by a qualified installer or service technician.
 - To eliminate the risk of burns or fire by reaching over heated surface elements, cabinet storage located above the surface units should be avoided. If cabinet storage space is to be provided, the risk can be reduced by installing a range hood that projects horizontally a minimum of 5" beyond the bottom of the cabinets. Cabinet installation above the cooktop may be no deeper than 13".
 - Make sure the cabinets and wall coverings around the cooktop can withstand the temperatures (up to 200°F) generated by the cooktop.
 - The cooktop should be easy to reach and lighted with natural light during the day.
 - Always disconnect the electrical service to the cooktop before repairing or servicing the cooktop. This can be done by disconnecting the fuse or circuit breaker. Failure to do this could result in a dangerous or fatal shock. Know where your main disconnect switch is located. If you do not know, have your electrician show you.
- Check local building codes for the proper method of cooktop installation. Local codes vary. Installation, electrical connections and grounding must comply with applicable codes.

Electrical Requirements

This appliance must be supplied with the proper voltage and frequency, and connected to an individual, properly grounded branch circuit, protected by a circuit breaker or a time delay fuse as noted on the rating plate.

We recommend you have the electrical wiring and hookup of your cooktop connected by a qualified electrician. After installation, have the electrician show you where your main range disconnect is located.

Wiring must conform to the National Electrical Code. You can get a copy of the National Electrical Code, ANSI/NFPA No. 70-Latest Edition, by writing:

National Fire Protection Association
Batterymarch Park
Quincy, MA 02269

The cooktop conduit wiring is approved for copper wire connection only, and if you have aluminum house wiring, you must use special UL approved connectors for joining copper to aluminum.

You must use a two-wire, three conductor 208/240VAC, 60 Hertz electrical system. A white (neutral) wire is not needed for this unit. The cooktop must be installed in a circuit that does not exceed 125 VAC nominal to ground. Refer to the rating plate on your cooktop for the KW rating for your cooktop.

Contents

Design Information

Models Available 3

Advance Planning 3

Tools & Materials Required 4

Preparing the Opening

Minimum Clearances 4

Overall Cooktop Dimensions 4

Vertical Clearance 5

Cutout Dimensions 5

Wall Coverings, Countertop & Cabinets 5

Installation

Installing Junction Box 5

Protecting the Surface of the Cooktop 5

Attach Foam Strips 6

Locate Mounting Parts 6

Attach Brackets to Cooktop 6

Insert the Cooktop into Cutout 6

Attach the Hold Down Bracket 6

Electrical Connections 7

Checking Installation & Cooktop Operations 8

Models Available

ZEU36R
Electronic Radiant Cooktop

Advance Planning



The electrical power to the cooktop supply line must be shut off while connections are being made. Failure to do so could result in serious injury or death.

Remove Installation Instructions from literature pack and read them carefully before you begin. Be sure to place all literature, Owner’s Manual, Installation Instructions, etc. in a safe place for future reference.

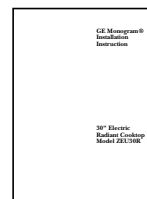

When preparing cooktop opening, make sure the inside of the cabinet and the cooktop do not interfere with each other. (See section on preparing the opening.)

Make sure you have all the tools and materials you need before starting the installation of the cooktop.

Remove packaging materials and literature package from the cooktop before beginning installation.

Your home must provide the adequate electrical service needed to safely and properly use your cooktop. (Refer to section on electrical requirements.)

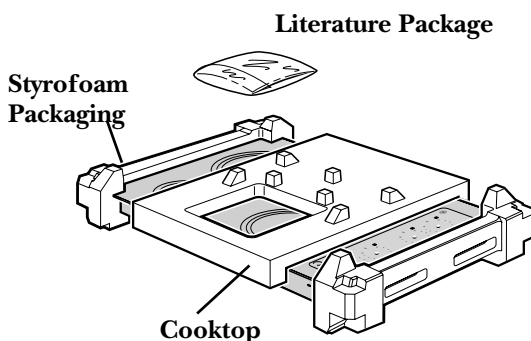

When installing your cooktop in your home, make sure all local codes and ordinances are followed exactly as stated.

Make sure the wall coverings, countertop and cabinets around the cooktop can withstand heat (up to 200°F) generated by the cooktop.

Preparing the Opening

Electronic Radiant Cooktop

Tools & Materials Required

Materials Needed

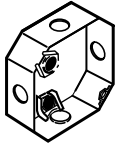

Junction Box



Wire Nuts

Tools You Will Need



1/8" Drill Bit & Electric or Hand Drill



Phillips Head Screwdriver



Pencil

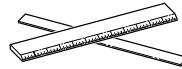

Ruler or Straightedge

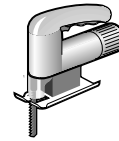

Saber Saw

Minimum Clearances

The following MINIMUM clearance dimensions must be maintained.

13" MAX. Depth of unprotected overhead cabinets

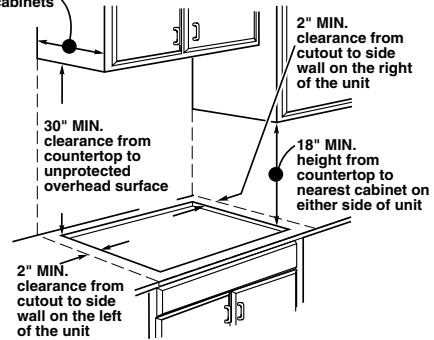

Overall Cooktop Dimensions

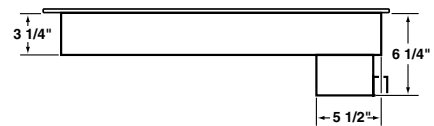
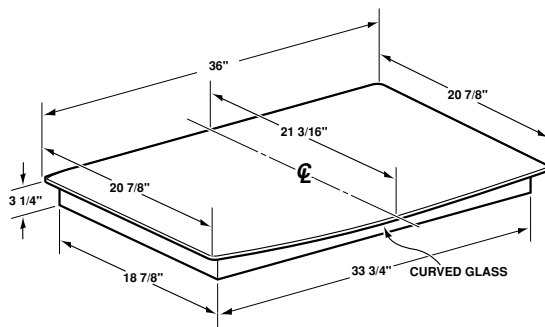

Vertical Clearance

Five inches (5") minimum vertical clearance between the cooktop bottom and any combustible surfaces.

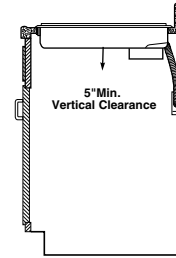

Cutout Dimensions of the Countertop

To insure accuracy, it is best to make a template when cutting the opening in the counter. Make sure there is clearance inside the cabinet before cutting the countertop.

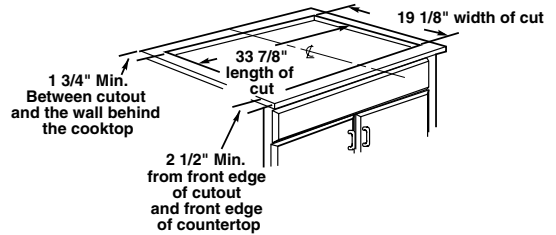

Wall Coverings, Countertop & Cabinets

Make sure the wall coverings, countertop and cabinets around the cooktop can withstand heat (up to 200°F) generated by the cooktop.

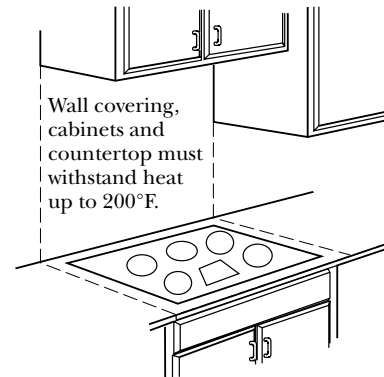

Installing the Junction Box

Install an approved junction box where it can be easily reached through the front of the cabinet where the cooktop will be located. **The cooktop conduit is 3 feet long.**



IMPORTANT: The junction box must be located where it will allow considerable slack in the conduit for serviceability.

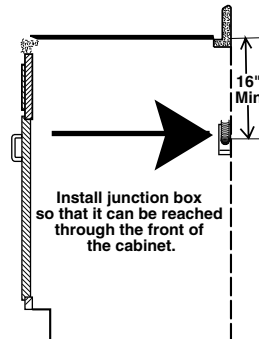

Protect Surface of Cooktop

Place a towel or tablecloth onto the countertop. Lay the cooktop upside down onto the protected surface.

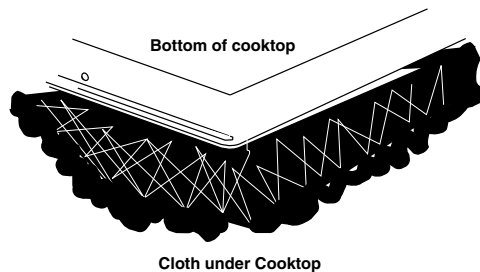

Installation

Electronic Radiant Cooktop

Attach Foam Strips

Apply the foam strips around the outer edge of the glass. **Do not overlap the foam strips.**

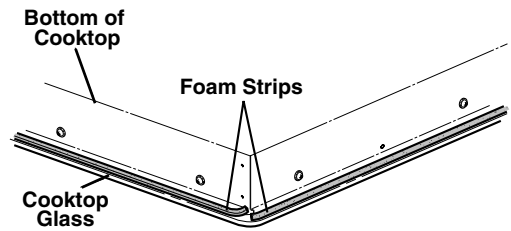

Locate Mounting Parts

Remove the hold down brackets and screws from the literature package.

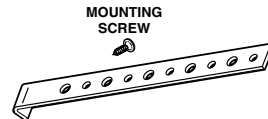

Attach Brackets to Cooktop

Screw the Hold Down Bracket to the side of the cooktop unit. Repeat for opposite side of cooktop.

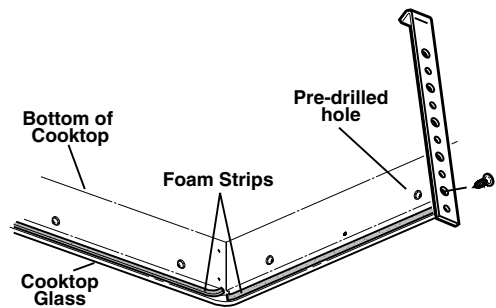

Insert Cooktop Into Cutout

Insert the cooktop centered into the cutout opening. Make sure the front edge of the countertop is parallel to the cooktop. Make final check that all required clearances are met.

! **IMPORTANT:** If the cooktop is being installed into a blind counter (one with no cabinet opening below), wire connections must be made before putting the cooktop into the cutout opening.

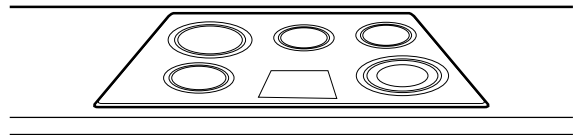
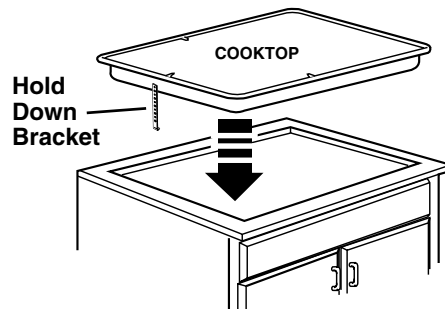

Attach Hold Down Brackets to Cabinet

Open the cabinet door and screw the Hold Down Brackets to the cabinet sides with the screws provided.

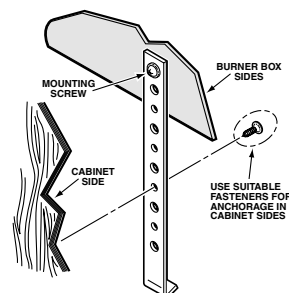

Step 1 When making the wire connections, use the entire length of conduit provided. **The conduit must not be shortened.**

Step 2 With the cooktop in place, open the front of the cabinet door.

Step 3 Insert the wires from the conduit through the opening of the junction box.

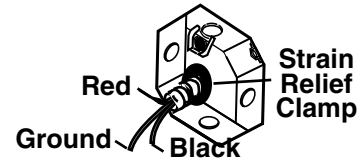

Step 4 Connect the red and black leads from the cooktop conduit to the corresponding leads in the junction box.

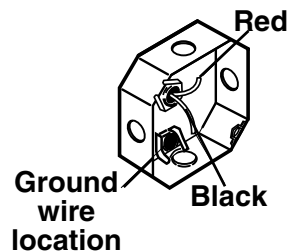

Step 5 Once the connections are made, secure wires together using wire nuts.

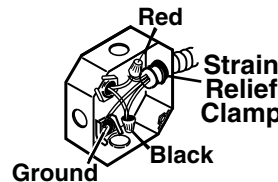

GROUNDING INSTRUCTIONS

The bare ground wire in the conduit is connected to the cooktop frame. Effective January 1, 1996, the National Electrical Code will not permit grounding through neutral. If used in new construction after January 1, 1996 or in a mobile home, recreational vehicle or if local codes do not permit grounding through the neutral white lead, attach the appliance grounding lead (green or copper) to the residence grounding conductor (green or bare copper) in accordance with local codes. When connecting to a 3 conductor branch circuit, if local codes permit, connect the bare ground connector lead of the cooktop to the branch circuit neutral (gray or white in color).

IMPORTANT: If the cooktop is being installed into a blind counter (one with no cabinet opening below), wire connections must be made before putting the cooktop into the cutout opening.

NOTE: ALUMINUM WIRING

A. WARNING:

IMPROPER CONNECTION OF ALUMINUM HOUSE WIRING TO THE COPPER LEADS CAN RESULT IN A SERIOUS PROBLEM.

B. Splice copper wires to aluminum wiring using special connectors designed and UL approved for joining copper to aluminum and follow the manufacturer's recommended connector procedure closely.

NOTE: Wire used, location and enclosure of splices, etc., must conform to good wiring practice and local codes.

Pre-Test Checklist

- Remove all protective film if present, and any stickers.
 - Check to be sure that all wiring is secure and not pinched or in contact with moving parts.
 - Check level of appliance.
 - Check that the cooktop is properly grounded.
-

Operation Checklist

- Remove all items from the top of the cooktop surface.
- Turn on the power to the cooktop. (Refer to your Owner's Manual.) Verify that all surface units operate properly.
- Check that the circuit breaker is not tripped nor the house fuse blown.
- Check that conduit is securely connected to the junction box.
- See Owner's Manual for troubleshooting list.
- **NOTE TO ELECTRICIAN:**
The power leads supplied with this appliance are UL recognized for connections to larger gauge household wiring. The insulation of these leads is rated at temperatures much higher than the temperature rating of household wiring. The current carrying capacity of a conductor is governed by the wire gauge and also the temperature rating of the insulation around the wire.

NOTE: While performing installations described in this book, safety glasses or goggles should be worn.

To obtain specific information concerning any Monogram product or service, call GE Answer Center[®] consumer information service at 800.626.2000—any time, day or night or visit our website at: Monogram.com.

For Monogram local service in your area, call 1.800.444.1845.

NOTE: Product improvement is a continuing endeavor at General Electric. Therefore, materials, appearance and specifications are subject to change without notice.



Monogram[®]

General Electric Company
Louisville, KY 40225

31-10544
229C4053P528
(09/02 JR)