

# Vent Hood® WALL MOUNT RANGE HOOD SPECIFICATIONS

ZTH Equipped with halogen lighting. These models not available with heat lamps. Only available in stainless steel. Shown with optional duct cover (sold separately). Optional duct covers available in standard and custom sizes (sold separately). Pot rail included.

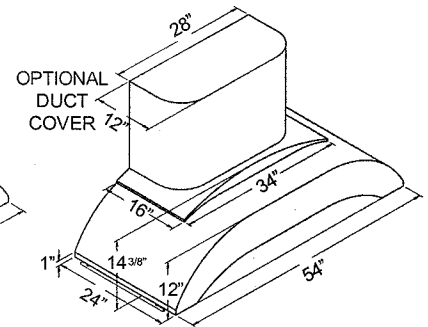
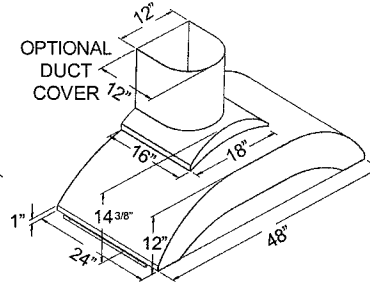
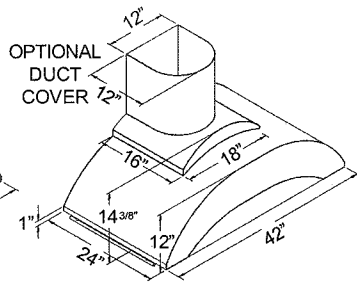
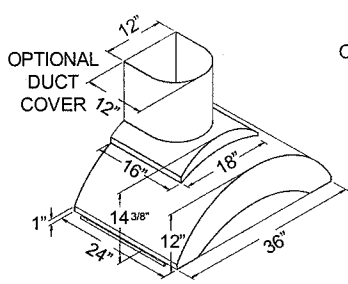

ZTH

## Blower Outlet Diagrams 36" - 48" Widths

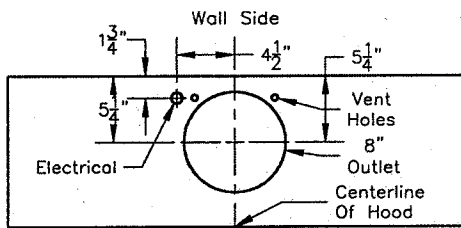

600 CFM B200 Dual Blower  
(Top View)

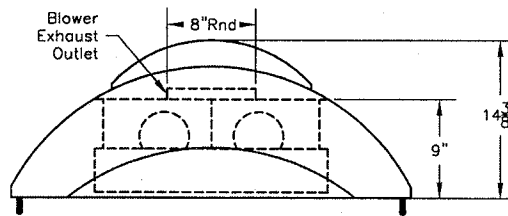

(Front View)

## Blower Outlet Diagram 54" Width

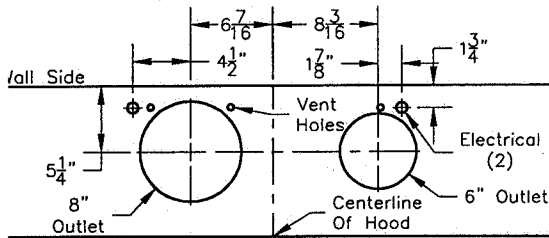

900 CFM B200 Dual Blower  
& B100 Single Blower  
(Top View)

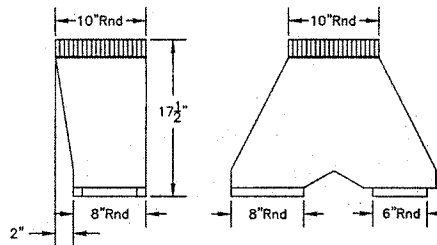

VP562 Transition (Optional) For B300  
(B200 Dual Blower & B100 Single Blower)

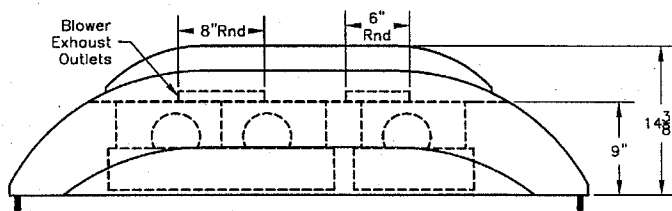

(Front View)

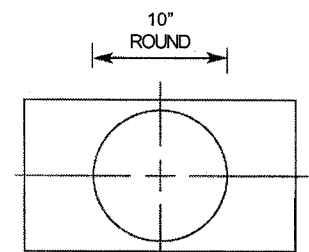
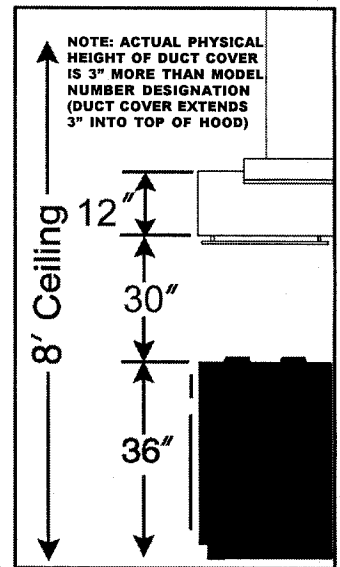

VP562 transition  
centers outlet  
over top of hood

## Electrical/Mechanical Specifications For Blower Units

Model	Type	Volts	Amps	HZ	RPM	CFM SP@.0"	Equivalent CFM	CFM SP@.0.1"	CFM SP@.0.2"	CFM SP@.0.3"	Minimum Round Duct Size	Square Inches
B100 Single	Shaded Pole	115	1.7●	60	1550	300	450	286	270	240	6" (or equivalent)	28
B200 Dual	(2) Shaded Pole	115	3.4●	60	1550	600	900	572	540	480	8" (or equivalent)	50

●Note: Add .5 amp for each halogen bulb. Equivalent CFM refers to the fact that the Magic Lung blower uses centrifugal filtration units, whereas others use conventional filters. Apply this guideline when comparing blower units made by other manufacturers. Halogen lights- 4 lights, one in each corner.