

FRIGIDAIRE

All about the

Use & Care

of your Wall Oven



TABLE OF CONTENTS

Welcome & Congratulations	2	Setting Oven Controls.....	24
Important Safety Instructions.....	3	Self-Cleaning.....	37
Microwave Oven Important Information	6	Care & Cleaning (Microwave Cleaning Chart)	39
Features at a Glance.....	9	Care & Cleaning (Oven Cleaning Chart).....	40
Microwave Parts Names & Control Panel	10	Care & Cleaning	41
Before Operating the Microwave Oven	11	Before You Call	42
Setting the Microwave Oven.....	11	Major Appliance Warranty	44
Before Setting Oven Controls	21		

WELCOME & CONGRATULATIONS

Product Registration Register Your Product

The **PRODUCT REGISTRATION CARD** should be filled in completely, signed and returned to Electrolux Home Products.

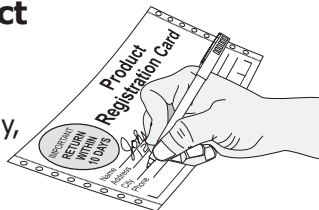

Congratulations on your purchase of a new appliance! At **Electrolux Home Products**, we are very proud of our product and are completely committed to providing you with the best service possible. Your satisfaction is our number one priority.

We know you'll enjoy your new appliance and **Thank You** for choosing our product. We hope you consider us for future purchases.

PLEASE CAREFULLY READ AND SAVE THESE INSTRUCTIONS

This Use & Care Manual contains general operating instructions for your appliance and feature information for several models. Your product **may not** have all the described features. The graphics shown are representative. The graphics on your appliance may not look exactly like those shown. These instructions are not meant to cover every possible condition and situation that may occur. Common sense and caution must be practiced when installing, operating and maintaining any appliance.

Serial Plate Location



Please record your model and serial numbers below for future reference.

Model Number: _____

Serial Number: _____

Purchase Date: _____

NOTE

Please attach sales receipt here for future reference.

IMPORTANT SAFETY INSTRUCTIONS

Read all instructions before using this appliance. Save these instructions for future reference.

DEFINITIONS

 This is the safety alert symbol. It is used to alert you to potential personal injury hazards. Obey all safety messages that follow this symbol to avoid possible injury or death.

WARNING

This symbol will help alert you to situations that may cause serious bodily harm, death or property damage.

CAUTION

This symbol will help alert you to situations that may cause bodily injury or property damage.

IMPORTANT

IMPORTANT indicates installation, operation or maintenance information which is important but not hazard-related.

PRECAUTIONS TO AVOID POSSIBLE EXPOSURE TO EXCESSIVE MICROWAVE ENERGY

For your safety the information in this manual must be followed to minimize the risk of fire or explosion or to prevent property damage, personal injury or loss of life.

- **Do Not Attempt** to operate this microwave oven with the door open since open-door operation can result in harmful exposure to microwave energy. It is important not to defeat or tamper with the safety interlocks.
- **Do Not Place** any object between the microwave oven front face and the door or allow soil or cleaner residue to accumulate on sealing surfaces.
- **Do Not Operate** the microwave oven if it is damaged. It is particularly important that the microwave oven door close properly and that there is no damage to the: **1.** door (bent), **2.** hinges and latches (broken or loosened), **3.** door seals and sealing surfaces.
- **The Microwave Oven Should Not** be adjusted or repaired by anyone except properly qualified service personnel.

- **Remove all tape and packaging wrap before using the appliance. Destroy the carton and plastic bags after unpacking the appliance.** Never allow children to play with packaging material. Do not remove the wiring label and other literature attached to the appliance. Do not remove model/serial number plate.
- **Proper Installation. Be sure your appliance is properly installed and grounded by a qualified technician in accordance with the National Electrical Code No. 70 - latest edition in the United States, or CSA C22.1, Part 1 in Canada, and local code requirements.** Install only per installation instructions provided in the literature package for this appliance.

Ask your dealer to recommend a qualified technician and an authorized repair service. Know how to disconnect the electrical power to the appliance at the circuit breaker or fuse box in case of an emergency.

- **User Servicing. Do not repair or replace any part of the appliance unless specifically recommended in the manuals.** All other servicing should be done only by a qualified technician to reduce the risk of personal injury and damage to the appliance.

WARNING



- All appliance can tip.
- Injury to persons could result.
- Install anti-tip bracket packed with your appliance.
- See Installation Instructions.



To reduce the risk of tipping, the appliance must be secured by properly installed anti-tip bracket provided with the unit. Refer to the Installation Instructions for proper anti-tip bracket installation.

- **Never modify or alter the construction of an appliance such as removal of panels, wire covers or any other permanent part of the appliance.**
- **Remove the oven door from any unused appliance if it is to be stored or discarded.**
- **Storage in or on Appliance—Flammable materials should not be stored in an oven.** This includes paper, plastic and cloth items, such as cookbooks, plasticware and towels, as well as flammable liquids. Do not store explosives, such as aerosol cans, in or near the appliance.

IMPORTANT SAFETY INSTRUCTIONS

WARNING

Stepping, leaning, sitting or pulling down on the door of this appliance can result in serious injuries and may also cause damage to the appliance. Do not allow children to climb or play around the appliance.

Do not use the oven for storage.

Never use your appliance for warming or heating the room.

CAUTION

Electronic controllers can be damaged by cold temperatures. When you use your appliance for the first time, or if it has not been used for a long period of time, make sure that it has been exposed to a temperature above 0°C/32°F for at least 3 hours before connecting it to the power supply.

Do not store items of interest to children in the cabinets above the appliance. Children climbing on the cooktop to reach items could be seriously injured.

- **Do not leave children alone. Children should not be left alone or unattended in the area where an appliance is in use.** They should never be allowed to sit or stand on any part of the appliance.
- **DO NOT TOUCH INTERIOR OVEN ELEMENTS OR INTERIOR SURFACES OF THE OVEN UNTIL THEY HAVE COOLED.** The oven heating elements may be hot even though the elements are dark in color. Areas near the elements may become hot enough to cause burns. During and after use, do not touch, or let clothing or other flammable materials touch these areas until they have had sufficient time to cool. Among these areas are the oven vent openings, the surfaces near these openings, oven door and window.
- **Wear Proper Apparel. Loose-fitting or hanging garments should never be worn while using the appliance.** Do not let clothing or other flammable materials contact hot surfaces.
- **Do Not Use Water or Flour on Grease Fires. Smother the fire with a pan lid, or use baking soda, a dry chemical or foam-type extinguisher.**
- **When heating fat or grease, watch it closely.** Fat or grease may catch fire if allowed to become too hot.
- **Use Only Dry Pot holders. Moist or damp pot holders on hot surfaces may result in burns from steam.** Do not let the pot holders touch hot surface units. Do not use a towel or other bulky cloth instead of a pot holder.

- **Do Not Heat Unopened Food Containers. Buildup of pressure may cause the container to burst and result in injury.**

IMPORTANT

Do not attempt to operate the appliance during a power failure. If the power fails, always turn off the unit. If the unit is not turned off and the power resumes, the appliance will not operate and an error message will be displayed.

IMPORTANT INSTRUCTIONS FOR USING YOUR MICROWAVE

- Read all instructions before using the appliance.
- Read and follow the specific **"PRECAUTIONS TO AVOID POSSIBLE EXPOSURE TO EXCESSIVE MICROWAVE ENERGY"** on page 3.

WARNING

To reduce the risk of fire, burns, electric shock, injury to persons, or exposure to excessive microwave energy when using your appliance, follow basic **precautions, including the following sections.**

- Some products such as whole eggs and sealed containers—for example, closed glass jars—are able to explode and should not be heated in this microwave oven.
- Use this appliance only for its intended use as described in this manual. Do not use corrosive chemicals or vapors in this appliance. This type of microwave oven is specifically designed to heat, cook or dry food. It is not designed for industrial or laboratory use.
- As with any appliance, close supervision is necessary when used by children.
- Do not operate this appliance if it has a damaged cord or plug, if it is not working properly or if it has been damaged or dropped.
- This appliance should be serviced only by qualified service personnel. Contact nearest Electrolux Authorized Servicer for examination, repair or adjustment.
- Do not cover or block any openings on the appliance.
- Do not store or use this appliance outdoors. Do not use this product near water—for example, near a kitchen sink, in a wet basement or near a swimming pool, or similar locations.
- See door surface cleaning instructions.
- To reduce the risk of fire in the microwave oven cavity:
 - Do not overcook food. Carefully attend appliance when paper, plastic or other combustible materials are placed inside the microwave oven to facilitate cooking.
 - Remove wire twist-ties from paper or plastic bags before placing bag in microwave oven.

IMPORTANT SAFETY INSTRUCTIONS

- **If materials inside the microwave oven should ignite, keep microwave oven door closed, turn microwave oven off and disconnect the power cord or shut off power at the fuse or circuit breaker panel.**
- Do not use the cavity for storage purposes. Do not leave paper products, cooking utensils or food in the cavity when not in use.
- Liquids, such as water, coffee or tea are able to be overheated beyond the boiling point without appearing to be boiling. Visible bubbling or boiling when the container is removed from the microwave oven is not always present. **THIS COULD RESULT IN VERY HOT LIQUIDS SUDDENLY BOILING OVER WHEN A SPOON OR OTHER UTENSIL IS INSERTED INTO THE LIQUID.**
To reduce the risk of injury to persons:
 - Do not overheat the liquid.
 - Stir the liquid both before and halfway through heating it.
 - Do not use straight-sided containers with narrow necks. Use a wide-mouthed container.
 - After heating, allow the container to stand in the microwave oven at least for 20 seconds before removing the container.
 - Use extreme care when inserting a spoon or other utensil into the container.
- If the microwave oven light fails, consult an Electrolux Authorized Servicer.

IMPORTANT SAFETY INSTRUCTIONS FOR USING YOUR OVEN

- **Use Care When Opening an Oven Door**—Stand to the side of the appliance when opening the door of a hot oven. Let hot air or steam escape before you remove or replace food in the oven.
- **Keep Oven Vent Ducts Unobstructed.** The wall oven is vented at the center trim under the control panel. Touching the surfaces in this area when the oven is operating may cause severe burns. Also, do not place plastic or heat-sensitive items near the oven vent. These items could melt or ignite.
- **Placement of Oven Racks.** Always place oven racks in desired location while oven is cool. Remove all utensils from the rack before removing rack. If rack must be moved while oven is hot, use extreme caution. Use pot holders and grasp the rack with both hands to reposition. Do not let pot holders contact the hot oven element or interior of the oven.
- **Do not use a broiler pan without its insert.** Broiler pan and grid allow dripping fat to drain and be kept away from the high heat of the broiler.
- **Do not cover the broiler grid or oven bottom with aluminum foil.** Exposed fat and grease could ignite.

- **Do not touch a hot oven light bulb with a damp cloth.** Doing so could cause the bulb to break. Disconnect the appliance or shut off the power to the appliance before removing and replacing the bulb.
- **Protective liners**—Do not use aluminum foil to line the oven bottom. Only use aluminum foil as recommended in this manual. Improper installation of these liners may result in risk of electric shock, or fire.

IMPORTANT SAFETY INSTRUCTIONS FOR CLEANING YOUR OVEN

- **Clean the appliance regularly to keep all parts free of grease that could catch fire.** Exhaust fan ventilation hoods and grease filters should be kept clean. Do not allow grease to accumulate. Greasy deposits in the fan could catch fire. Refer to the hood manufacturer's instructions for cleaning.
- **Cleaners/Aerosols**—Always follow the manufacturer's recommended directions for use. Be aware that excess residue from cleaners and aerosols may ignite causing damage and/or injury.
- **Clean in the self-cleaning cycle only the parts of the appliance listed in this Owner's Guide.** Before using the self-cleaning cycle of the appliance, remove all utensils stored in the appliance.
- **Do not clean the oven door gasket.** The door gasket is essential for a good seal. Care should be taken not to rub, damage or move the gasket.
- **Do not use oven cleaners.** No oven cleaner or oven liner protective coating of any kind should be used in or around any part of the appliance.

CAUTION

Limit use of microwave oven to 2-3 minutes during self-cleaning of the wall oven to lower risk of overheating the fuse.

CAUTION

The health of some birds is extremely sensitive to the fumes given off during the self-clean cycle of any wall oven. Move birds to another well ventilated room.

IMPORTANT SAFETY NOTICE

The California Safe Drinking Water and Toxic Enforcement Act requires the Governor of California to publish a list of substances known to the state to cause cancer, birth defects or other reproductive harm, and requires businesses to warn customers of potential exposure to such substances.

SAVE THESE INSTRUCTIONS

MICROWAVE OVEN IMPORTANT INFORMATION

Federal Communications Commission Radio Frequency Interference Statement (U.S.A. Only)

This equipment generates and uses ISM frequency energy and if not installed and used properly, that is in strict accordance with the manufacturer's instructions, may cause interference to radio and television reception. It has been type tested and found to comply with limits for ISM Equipment pursuant to part 18 of FCC Rules, which are designed to provide reasonable protection against such interference in a residential installation. However, there is no guarantee that interference will not occur in a particular installation. If this equipment does cause interference to radio or television reception, which can be determined by turning the equipment off and on, the user is encouraged to try to correct the interference by one or more of the following:

- Reorient the receiving antenna of the radio or television.
- Relocate the microwave oven with respect to the receiver.
- Move the microwave oven away from the receiver.
- Plug the microwave oven into a different outlet so that the microwave oven and the receiver are on different branch circuits.

The manufacturer is not responsible for any radio or television interference caused by unauthorized modification to this microwave oven. It is the responsibility of the user to correct such interference.

ABOUT YOUR MICROWAVE OVEN

This Use and Care Manual is valuable: read it carefully and always save it for reference.

A good microwave cookbook is a valuable asset. Check it for microwave cooking principles, techniques, hints and recipes.

NEVER use the microwave oven without the turntable and support nor turn the turntable over so that a large dish could be placed in the microwave oven. The turntable will turn both clockwise and counterclockwise.

ALWAYS have food in the microwave oven when it is on to absorb the microwave energy.

When using the microwave oven at power levels below 100%, you may hear the magnetron cycling on and off. It is normal for the exterior of the microwave oven to be

warm to the touch when cooking or reheating. Condensation is a normal part of microwave cooking. Room humidity and the moisture in food will influence the amount of moisture that condenses in the microwave oven. Generally, covered foods will not cause as much condensation as uncovered ones. Ventilation openings must not be blocked.

The microwave oven is for food preparation only. It should not be used to dry clothes or newspapers. All microwave ovens are rated by using the IEC Test Procedure as 1200 watts, except for CPM0209 and CGMO205 which are 1100 watts. In using recipes or package directions, check food a minute or two before the minimum time and add time accordingly.

ABOUT MICROWAVE COOKING

- Arrange food carefully. Place thickest areas towards outside of dish.
- Watch cooking time. Cook for the shortest amount of time indicated and add more as needed. Food severely overcooked can smoke or ignite.
- Cover foods while cooking. Check recipe or cookbook for suggestions: paper towels, wax paper, microwave plastic wrap or a lid. Covers prevent splattering and help foods to cook evenly.
- Shield with small flat pieces of aluminum foil any thin areas of meat or poultry to prevent overcooking before dense, thick areas are cooked thoroughly.
- Stir foods from outside to center of dish once or twice during cooking, if possible.
- Turn foods over once during microwaving to speed cooking of such foods as chicken and hamburgers. Large items like roasts must be turned over at least once.
- Rearrange foods such as meatballs halfway through cooking both from top to bottom and from the center of the dish to the outside.
- Add standing time. Remove food from microwave oven and stir, if possible. Cover for standing time which allows the food to finish cooking without overcooking.
- Check for doneness. Look for signs indicating that cooking temperatures have been reached.
- **Doneness signs include:**
 - Food steams throughout, not just at edge.
 - Center bottom of dish is very hot to the touch.
 - Poultry thigh joints move easily.
 - Meat and poultry show no pinkness.
 - Fish is opaque and flakes easily with a fork.

MICROWAVE OVEN IMPORTANT INFORMATION

ABOUT FOODS

Food	Do	Don't
Eggs, sausages, nuts, seeds, fruits & vegetables	<ul style="list-style-type: none"> • Puncture egg yolks before cooking to prevent "explosion". • Pierce skins of potatoes, apples, squash, hot dogs and sausages so that steam escapes. 	<ul style="list-style-type: none"> • Cook eggs in shells. • Reheat whole eggs. • Dry nuts or seeds in shells.
Popcorn	<ul style="list-style-type: none"> • Use specially bagged popcorn for microwave cooking. • Listen while popping corn for the popping to slow to 1 or 2 seconds or use special popcorn pad. 	<ul style="list-style-type: none"> • Pop popcorn in regular brown bags or glass bowls. • Exceed maximum time on popcorn package.
Baby food	<ul style="list-style-type: none"> • Transfer baby food to small dish and heat carefully, stirring often. Check temperature before serving. • Put nipples on bottles after heating and shake thoroughly. "Wrist" test before feeding. 	<ul style="list-style-type: none"> • Heat disposable bottles. • Heat bottles with nipples on. • Heat baby food in original jars.
General	<ul style="list-style-type: none"> • Cut baked goods with filling after heating to release steam and avoid burns. • Stir liquids briskly before and after heating to avoid "eruption". • Use deep bowl, when cooking liquids or cereals, to prevent boilovers. 	<ul style="list-style-type: none"> • Heat or cook in closed glass jars or air tight containers. • Can in the microwave as harmful bacteria may not be destroyed. • Deep fat fry. • Dry wood, gourds, herbs or wet papers.

ABOUT UTENSILS AND COVERINGS

It is not necessary to buy all new cookware. Many pieces already in your kitchen can be used successfully in your new microwave oven. Make sure the utensil does not touch the interior walls during cooking.

Use these utensils for safe microwave cooking and reheating:

- Glass ceramic (Pyroceram®), such as Corningware®.
- Heat-resistant glass (Pyrex®)
- Microwave-safe plastics
- Paper plates
- Microwave-safe pottery, stoneware and porcelain
- Browning dish (Do not exceed recommended preheating time. Follow manufacturer's directions.)

These items can be used for short time reheating of foods that have little fat or sugar in them:

- Wood, straw, wicker

DO NOT USE

- Metal pans and bakeware
- Dishes with metallic trim
- Non-heat-resistant glass
- Non-microwave-safe plastics (margarine tubs)
- Recycled paper products
- Brown paper bags
- Food storage bags
- Metal twist-ties

Should you wish to check if a dish is safe for microwaving, place the empty dish in the microwave oven and microwave on HIGH for 30 seconds. A dish which becomes very hot should not be used.

The following coverings are ideal:

- Paper towels are good for covering foods for reheating and absorbing fat while cooking bacon.
- Wax paper can be used for cooking and reheating.
- Plastic wrap that is specially marked for microwave use can be used for cooking and reheating. DO NOT allow plastic wrap to touch food. Vent so steam can escape.
- Lids that are microwave-safe are a good choice because heat is kept near the food to hasten cooking.
- Oven cooking bags are good for large meats or foods that need tenderizing. DO NOT use metal twist ties. Remember to slit bag so steam can escape.

How to use aluminum foil in your microwave oven:

- Small flat pieces of aluminum foil placed smoothly on the food can be used to shield areas that are either defrosting or cooking too quickly.
- Foil should not come closer than one inch to any surface of the microwave oven.

Should you have questions about utensils or coverings, check a good microwave cookbook or follow recipe suggestions.

ACCESSORIES There are many microwave accessories available for purchase. Evaluate carefully before you purchase so that they meet your needs. A microwave-safe thermometer will assist you in determining correct doneness and assure you that foods have been cooked to safe temperatures. Electrolux is not responsible for any damage to the microwave oven when accessories are used.

MICROWAVE OVEN IMPORTANT INFORMATION

ABOUT CHILDREN AND THE MICROWAVE

Children below the age of 7 should use the microwave oven with a supervising person very near to them. Between the ages of 7 and 12, the supervising person should be in the same room.

At no time should anyone be allowed to lean or swing on the microwave oven door.

Children should be taught all safety precautions: use potholders, remove coverings carefully, pay special attention to packages that crisp food because they may be extra hot. Don't assume that because a child has mastered one cooking skill he/she can cook everything.

Children need to learn that the microwave oven is not a toy. See page 15 for Child Lock feature.

ABOUT SAFETY

- Check foods to see that they are cooked to the United States Department of Agriculture's recommended temperatures.

160½F - For fresh pork, ground meat, boneless white poultry, fish, seafood, egg dishes and frozen prepared food.

165½F - For leftover, ready-to-reheat refrigerated, and deli and carry-out fresh food.

170½F - White meat of poultry.

175½F - Dark meat of poultry.

To test for doneness, insert a meat thermometer in a thick or dense area away from fat or bone. NEVER leave the thermometer in the food during cooking, unless it is approved for microwave oven use.

- ALWAYS use potholders to prevent burns when handling utensils that are in contact with hot food. Enough heat from the food can transfer through utensils to cause skin burns.
- Avoid steam burns by directing steam away from the face and hands. Slowly lift the farthest edge of a dish's covering and carefully open popcorn and oven cooking bags away from the face.
- Stay near the microwave oven while it's in use and check cooking progress frequently so that there is no chance of overcooking food.
- NEVER use the cavity for storing cookbooks or other items.
- Select, store and handle food carefully to preserve its high quality and minimize the spread of foodborne bacteria.
- Keep waveguide cover clean. Food residue can cause arcing and/or fires.
- Use care when removing items from the microwave oven so that the utensil, your clothes or accessories do not touch the safety door latches.

FEATURES AT A GLANCE

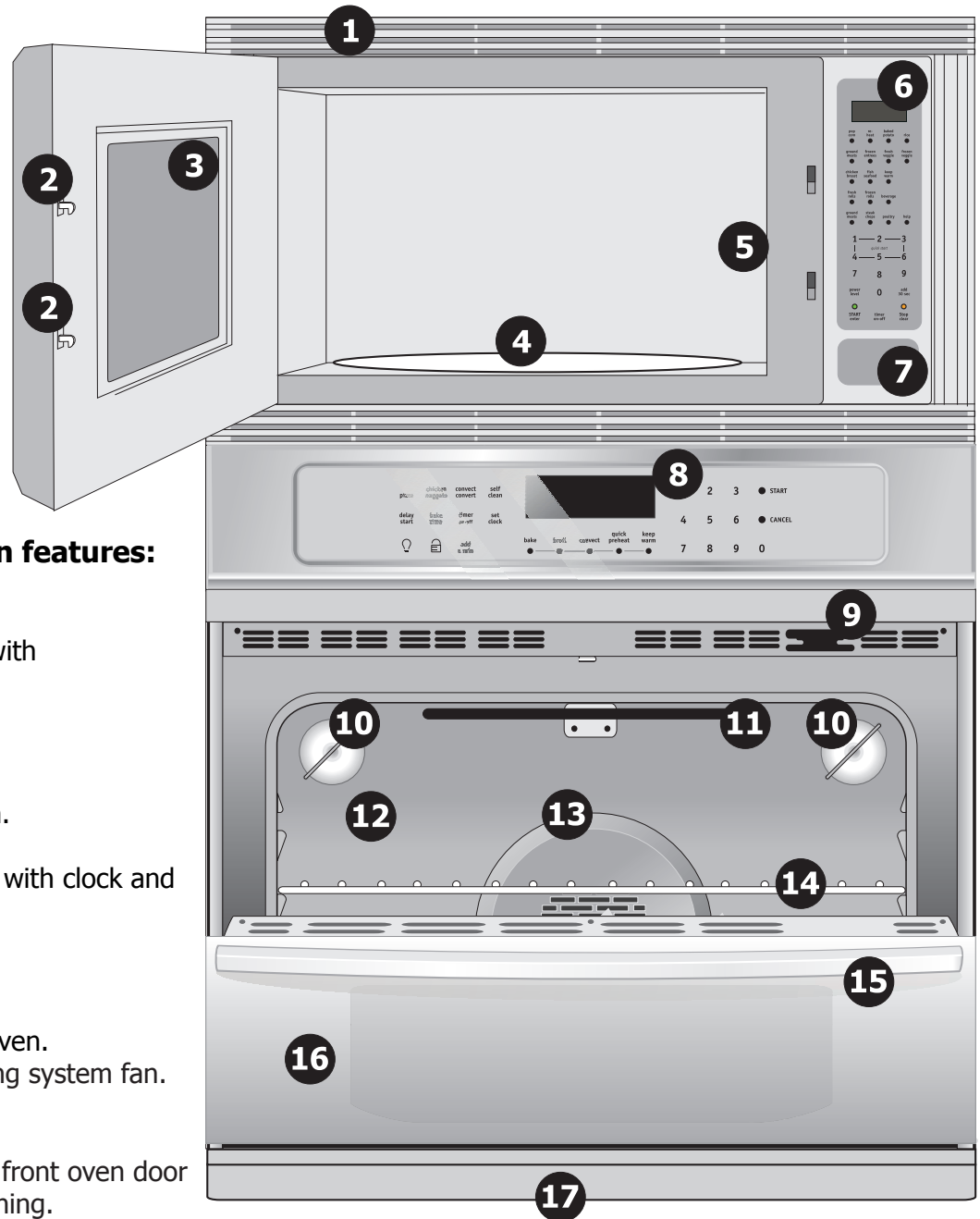

Your electric wall oven features:

1. Upper oven grill.
2. Safety door latches.
3. Microwave oven door with see-through window.
4. Microwave turntable.
5. Microwave oven light.
6. Microwave control.
7. Open door push button.

8. Electronic oven control with clock and kitchen timer.
9. Oven vent.
10. Oven light.
11. Broil element.
12. Self-clean convection oven.
13. Convection bake cooking system fan.
14. Adjustable oven rack.
15. Door handle.
16. Glass or stainless steel front oven door with large window opening.
17. Bottom trim

NOTE

The features shown for your appliance may vary according to model type & color.

MICROWAVE PART NAMES & CONTROL PANEL

sensor cook	auto cook	auto reheat	auto defrost	snack menu	melt/soften
1 Frozen Entrees	1 Pizza	1 Fresh Rolls/ Muffins	1 Ground meat	1 Hand-held snacks 3-4 oz	1 Butter
2 Ground Meat	2 Hot Dogs	2 Frozen Rolls/ Muffins	2 Steaks/Chops/Fish	2 Hand-held snacks 5-6 oz	2 Chocolate
3 Rice	3 Beverage	3 Pasta	3 Chicken Pieces	3 Frozen Kid's Meal	3 Ice Cream
4 Chicken Breast			4 Roast		4 Cream Cheese
5 Fish/seafood			5 Casserole		
			6 Soup		

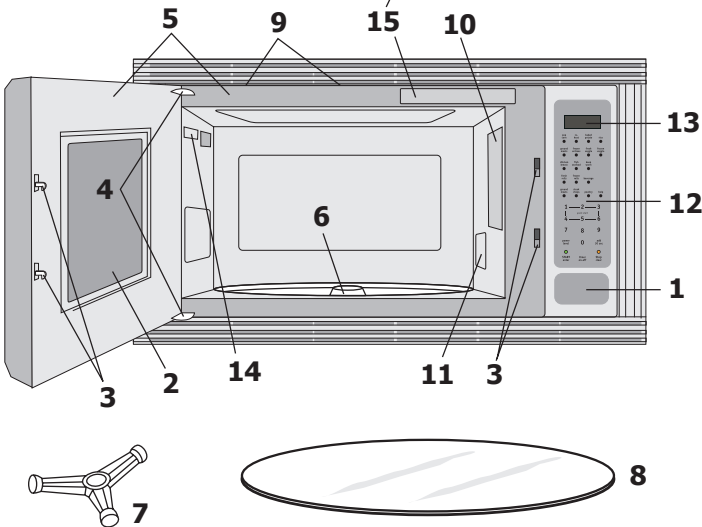

- 1 One touch door open button
Push to open door
- 2 Microwave Oven door with see-through window.
- 3 Safety door latches
The Microwave Oven will not operate unless the door is securely closed.
- 4 Door hinges
- 5 Door seals and sealing surfaces
- 6 Turntable motor shaft
- 7 Removable turntable support
Carefully place the turntable support in the center of the Microwave Oven floor.
- 8 Removable turntable
Place the turntable on the turntable support securely. The turntable will rotate clockwise or counterclockwise. Only remove for cleaning.
- 9 Ventilation openings (rear)
- 10 Microwave Oven light
It will light when Microwave Oven is operating or door is open.
- 11 Waveguide cover: **DO NOT REMOVE.**
- 12 Auto-Touch control panel
- 13 Time display: 99 minutes, 99 seconds
- 14 Serial plate
- 15 Menu Label

The 7-digit Interactive Display spells out operating steps and shows cooking hints. When HELP is lighted in the display, press the user pref pad to read a specific hint which may assist you.

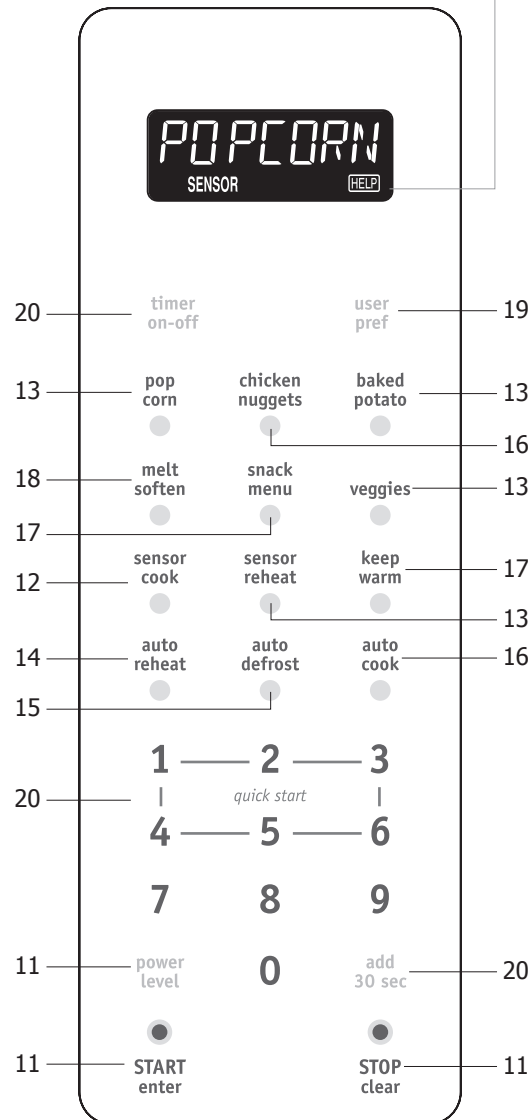

Number next to the control panel illustration indicates page on which there is a feature description and usage information.

NOTE

When a pad is pressed, an audible signal will be heard which confirms the pad has been pressed.

NOTE

The features shown for your appliance may vary according to model type & color.

BEFORE OPERATING THE MICROWAVE OVEN

- Before operating your new microwave oven, make sure you read and understand this Use and Care manual completely.
- Before the microwave oven can be used, follow these procedures:
 1. Plug in the microwave oven. Close the door. The microwave oven display will show *ENJOY YOUR OVEN PRESS CLEAR*.
 2. Press the **STOP/clear** pad. : will appear.
 3. Set clock. See USER PREFERENCE on page 19.
- If the electrical power supply to your microwave oven should be interrupted, the display will intermittently show after the power is reinstated. If this occurs during cooking, the program will be erased. The time of day will also be erased. Simply press **STOP/clear** pad and reset the clock for the correct time of day.

NOTE

Your microwave oven can be programmed with the door open except for **START/enter, SENSOR COOKING, SENSOR REHEAT, INSTANT SENSOR, AUTO DEFROST** and **ADD 30 SEC.**

STOP/CLEAR

Press the **STOP/clear** pad to:

1. Erase if you make a mistake during programming.
2. Cancel timer.
3. Stop the microwave oven temporarily during cooking.
4. Return the time of day to the display.
5. Cancel a program during cooking, press twice.

SETTING THE MICROWAVE OVEN

MANUAL OPERATION

TIME COOKING

Your microwave oven can be programmed for 99 minutes 99 seconds (99.99). Always enter the seconds after the minutes, even if they are both zeros.

- Suppose you want to cook for 5 minutes at 100%.

STEP	PRESS
1. Enter cooking time 5,0,0 .	
2. Press START/enter pad.	

TO SET POWER LEVEL

There are eleven preset power levels. Using lower power levels increases the cooking time, which is recommended for foods such as cheese, milk and long slow cooking of meats. Consult cookbook or recipes for specific recommendations.

PRESS POWER LEVEL PAD NUMBER OF TIMES FOR DESIRED POWER	APPROXIMATE PERCENTAGE OF POWER	COMMON WORDS FOR POWER LEVELS
POWER LEVEL x 1	100%	High
POWER LEVEL x 2	90%	
POWER LEVEL x 3	80%	
POWER LEVEL x 4	70%	Medium High
POWER LEVEL x 5	60%	
POWER LEVEL x 6	50%	Medium
POWER LEVEL x 7	40%	
POWER LEVEL x 8	30%	Med Low/Defrost
POWER LEVEL x 9	20%	
POWER LEVEL x 10	10%	Low
POWER LEVEL x 11	0%	

- Suppose you want to defrost for 5 minutes at 30%.

STEP	PRESS
1. Enter defrosting time. 5,0,0 .	
2. Press power level pad eight times or hold down until the desired power level appears.	
3. Press START/enter pad.	
4. When the defrost time is complete, a long tone will sound and END will appear in the display.	

MANUAL DEFROST

If the food that you wish to defrost is not listed on the DEFROST CHART or is above or below the limits in the Amount column on the DEFROST CHART, you need to defrost manually. You can defrost any frozen food, either raw or previously cooked, by using **power level** for 30%. Follow the exact 3-step procedure found under TO SET POWER LEVEL. Estimate defrosting time and press **power level** pad eight times for 30%.

For either raw or previously cooked frozen food, the rule of thumb is approximately 4 minutes per pound. For example, defrost 4 minutes for 1 pound of frozen spaghetti sauce. Always stop the microwave oven periodically to remove or separate the portions that are defrosted. If food is not defrosted at the end of the estimated defrosting time, program the microwave oven in 1 minute increments on **power level** 30% until totally defrosted.

When using plastic containers from the freezer, defrost only long enough to remove from the plastic in order to place in a microwave-safe dish.

SETTING THE MICROWAVE OVEN

SENSOR COOKING

Electrolux's Sensor is a semi-conductor device that detects the vapor (moisture and humidity) emitted from the food as it heats. The sensor adjusts the cooking times and power level for various foods and quantities.

Using Sensor Cooking:

1. After microwave oven is plugged in, wait 2 minutes before using SENSOR COOKING settings.
2. Be sure the exterior of the cooking container and the interior of the microwave oven are dry. Wipe off any moisture with a dry cloth or paper towel.
3. The microwave oven works with foods at normal storage temperature. For example, rice would be at room temperature.
4. Any Sensor Cooking selection can be programmed with MORE OR LESS TIME ADJUSTMENT. See page 18.
5. More or less food than the quantity listed in the chart should be cooked following the guidelines in any microwave cookbook.
6. During the first part of Sensor Cooking, food name will appear on the display. Do not open the microwave oven door or press **STOP/clear** during this part of the cooking cycle. The measurement of vapor will be interrupted. If this occurs, an error message will appear. To continue cooking, press the **STOP/clear** pad and cook manually.

When the sensor detects the vapor emitted from the food, remainder of cooking time will appear. Door may be opened when remaining cooking time appears on the display. At this time, you may stir or season food, as desired.

7. If the sensor does not detect vapor properly when popping popcorn, the oven will turn off, and the correct time of day will be displayed. If the sensor does not detect vapor properly when cooking other foods, ERROR will be displayed. Follow the instructions.

8. Check food for temperature after cooking. If additional time is needed, continue to cook manually.
9. INSTANT SENSOR and SENSOR REHEAT can only be entered within 3 minutes after cooking, opening and closing the door or pressing the STOP/clear pad.
10. Each food has a cooking hint. Press user pref pad when the HELP indicator is lighted in the display.

Covering Foods:

Some foods work best when covered. Use the cover recommended in the food charts.



1. Casserole lid.
2. Plastic wrap: Use plastic wrap recommended for microwave cooking. Cover dish loosely; allow approximately 1/2 inch to remain uncovered to allow steam to escape. Plastic wrap should not touch food.
3. Wax paper: Cover dish completely; fold excess wrap under dish to secure. If dish is wider than paper, overlap two pieces at least one inch to cover.

Be careful when removing any covering to allow steam to escape away from you.

EXAMPLE:

You can cook many foods by pressing the sensor cook pad and the food number. You don't need to calculate cooking time or power level.

- Suppose you want to cook ground meat.

STEP	PRESS
1. Press sensor cook pad, number 2 for ground meat.	 
2. Press START/enter pad.	

When sensor detects the vapor emitted from the food, remainder of reheating time will appear.

SENSOR COOKING CHART

FOOD	AMOUNT	PROCEDURE
1. Frozen Entrees	6 - 17 oz	Use this pad for frozen convenience foods. It will give satisfactory results for most brands. You may wish to try several and choose your favorite. Remove package from outer wrapping and follow package directions for covering. After cooking, let stand, covered, for 1-3 minutes.
2. Ground Meat	0.25 - 2.0 lb	Use this setting to cook ground beef or turkey as patties or in a casserole to be added to other ingredients. Place patties on a microwave-safe rack and cover with wax paper. Place ground meat in a casserole and cover with wax paper or plastic wrap. When microwave oven stops, turn patties over or stir meat in casserole to break up large pieces. Re-cover and press START/enter . After cooking, let stand, covered, for 2 to 3 minutes.

SETTING THE MICROWAVE OVEN

SENSOR COOKING CHART

FOOD	AMOUNT	PROCEDURE															
1. Rice	0.5 - 2.0 cups	Place rice into a deep casserole and add double quantity of water. Cover with lid or plastic wrap. After cooking, stir, cover and let stand 3 to 5 minutes or until all liquid has been absorbed. <table border="1" style="margin-left: auto; margin-right: auto;"> <thead> <tr> <th>Rice</th> <th>Water</th> <th>Size of casserole</th> </tr> </thead> <tbody> <tr> <td>.5 cup</td> <td>1 cup</td> <td>1.5 quart</td> </tr> <tr> <td>1 cup</td> <td>2 cups</td> <td>2 quart</td> </tr> <tr> <td>1.5 cups</td> <td>3 cups</td> <td>2.5 or 3 quart</td> </tr> <tr> <td>2 cups</td> <td>4 cups</td> <td>3 quart or larger</td> </tr> </tbody> </table>	Rice	Water	Size of casserole	.5 cup	1 cup	1.5 quart	1 cup	2 cups	2 quart	1.5 cups	3 cups	2.5 or 3 quart	2 cups	4 cups	3 quart or larger
Rice	Water	Size of casserole															
.5 cup	1 cup	1.5 quart															
1 cup	2 cups	2 quart															
1.5 cups	3 cups	2.5 or 3 quart															
2 cups	4 cups	3 quart or larger															
2. Chicken Breasts	0.5 - 2.0 lb	Cover with vented plastic wrap. When microwave oven stops, turn over. Shield with small, flat pieces of aluminum foil any areas that are cooking too rapidly. Re-cover and press START/enter . After cooking, let stand, covered for 3-5 minutes. Chicken should be 160°F.															
3. Fish Seafood	0.25 - 2.0 lb	Arrange in ring around shallow glass dish (roll fillet with edges underneath). Cover with vented plastic wrap. After cooking, let stand, covered for 3 minutes.															

INSTANT SENSOR

Instant sensor buttons allow you to cook or reheat by pressing just one pad.

- Suppose you want to cook a baked potato.

STEP	PRESS
Press baked potato pad. The microwave oven starts automatically.	

INSTANT SENSOR CHART

FOOD	AMOUNT	PROCEDURE
Baked Potato	1 - 8 med.	Pierce with fork in several places. Place on paper towel on turntable. After cooking, remove from oven and let stand wrapped in foil for 5 to 10 minutes.
Popcorn	1 package 1.5 - 3.5 oz bag	Use only popcorn packaged for microwave oven use. Try several brands to decide which you like. Do not try to pop unpopped kernels.
Veggies	0.25 - 2.0 lb 0.25 - 2.0 lb 0.25 - 1.25 lb	Press veggies pad once for soft veggies. Press veggies pad twice for hard veggies. Press veggies pad three times for frozen veggies.

SENSOR REHEAT

You can reheat many foods and don't need to calculate cooking time or power level.

STEP	PRESS
Press sensor reheat and after 2 seconds, it will automatically start.	
When the sensor detects the vapor emitted from the food, the remainder of cooking/reheating time will appear.	

SENSOR REHEAT CHART





FOOD	AMOUNT	PROCEDURE
Sensor Reheat	4-36 oz.	Place in dish or casserole slightly larger than amount to be reheated. Flatten, if possible. Cover with lid, plastic wrap or wax paper. Use covers such as plastic wrap or lids with larger quantities of more dense foods such as stews. After reheating, stir well, if possible. Re-cover and allow to stand 2 to 3 minutes. Foods should be very hot. If not, continue to heat with variable power and time.

SETTING THE MICROWAVE OVEN

AUTO REHEAT

AUTO REHEAT automatically computes the correct warming and heating time and microwave power level for foods shown in the chart below.

- Suppose you want to heat 2 fresh rolls or muffins.

STEP	PRESS
1. Press auto reheat .	
2. Press 1 for fresh rolls or muffins. Then press 2 for 2 fresh rolls or muffins.	 
3. Press START/enter .	

NOTE

1. AUTO REHEAT can be programmed with MORE or LESS TIME ADJUSTMENT. See page 20.
2. The final result will vary according to the food condition (e.g. initial temperature, shape, quality). Check food for temperature after heating. If additional time is needed, continue to heat manually.

AUTO REHEAT CHART







FOOD	AMOUNT	PROCEDURE
1. Fresh Rolls/ Muffins	1 - 10 pieces	Use this pad to warm rolls, muffins, biscuits, bagels etc. Large items should be considered as 2 or 3 regular size. Arrange on plate; cover with paper towel. For refrigerated rolls or muffins, it may be necessary to double the entered amount to ensure the proper serving temperature. For example, enter quantity of 2 for 1 refrigerated muffin.
2. Frozen Rolls/ Muffins	1 - 10 pieces	Use this pad to warm frozen rolls, muffins, biscuits, bagels, etc. Large items should be considered as 2 or 3 regular size. Arrange on plate, cover with paper towel.
3. Pasta	1.0 - 6.0 cups	Use this pad to reheat refrigerated canned or homemade pasta with sauce. For room temperature pastas, use LESS option. Pasta without sauce double the quantity per setting. For example, measure 2 cups of cooked noodles and program for 1 cup. Cover with lid or plastic wrap. Press auto reheat pad 3 times. Enter the desired number of cups and press START/enter . After cooking, let stand, covered, 2 to 3 minutes.

SETTING THE MICROWAVE OVEN

AUTO DEFROST

AUTO DEFROST automatically defrosts all the foods found in the AUTO DEFROST chart below.

- Suppose you want to defrost a 2.0 pound steak.

STEP	PRESS
1. Press auto defrost and 2 for Steak/Chops/Fish.	 , 
2. Enter weight.	 
3. Press START/enter . The oven will stop so the food can be checked.	
4. After the 1st stage, open the door. Turn steak over and shield any warm portions. Close the door. Press START pad.	
5. After the 2nd stage, open the door. Shield any warm portions. Close the door. Press START pad.	
6. After defrost cycle ends, let stand, covered.	

NOTES

1. If you attempt to enter more or less than the allowed weight as indicated in chart, ERROR will appear in the display.
2. AUTO DEFROST can be programmed with MORE OR LESS TIME ADJUSTMENT. See page 20.
3. To defrost other foods or foods above or below the weights allowed on AUTO DEFROST CHART use time and 30% power. See MANUAL DEFROST on page 11.
4. You may choose to enter the weight in tenths of pounds. This procedure may be easier with larger weights, such as 3 pounds, because it requires fewer touches. To program, press desired food number and enter weight. Ex: press **Steaks/Chops/Fish** then **3** and **0** for a weight of three pounds or press **Steaks/Chops/Fish** then **2** and **2** for a weight of 2.2 lb.
5. Press **user pref** pad when the HELP indicator is lighted in the display for a helpful hint.
6. Check foods when oven signals. After final stage, small sections may still be icy. Let stand to continue thawing. Do not defrost until all ice crystals thawed.
7. Shielding prevents cooking from occurring before the center of the food is defrosted. Use small smooth strips of aluminum foil to cover edges and thinner sections of the food.

AUTO DEFROST CHART





FOOD	AMOUNT	PROCEDURE
1. Ground Meat	0.5 - 3.0 lb	Remove any thawed pieces after each stage. Let stand, covered, for 5 to 10 minutes.
2. Steaks/Chops/Fish	0.5 - 4.0 lb	After each stage, rearrange and if there are warm or thawed portions, shield with small flat pieces of aluminum foil. Remove any meat or fish that is nearly defrosted. Let stand, covered, for 10 to 20 minutes.
3. Chicken Pieces	0.5 - 3.0 lb	After each stage, if there are warm or thawed portions, rearrange or remove. Let stand, covered, for 10 to 20 minutes.
4. Roast	2.0 - 4.0 lb	Start defrosting with fat side down. After each stage, turn roast over and shield the warm portions with aluminum foil. Let stand, covered, for 30-60 minutes.
5. Casserole	2 - 6 cups	After audible signal, stir if possible. At end, stir well and let stand, covered, for 5 to 10 minutes.
6. Soup	1 - 6 cups	After audible signal, stir if possible. At end, stir well and let stand, covered, for 5 to 10 minutes.

SETTING THE MICROWAVE OVEN

AUTO COOK

Auto Cook computes the correct cooking time and microwave power level for foods shown in the chart below.

- Suppose you want to cook 1 slice of pizza.

STEP	PRESS
1. Press auto cook and 1 for pizza.	 
2. Enter quantity.	
3. Press START/enter .	

TIPS: Food can be covered with wax paper or vented plastic wrap. Temperatures of foods covered with plastic wrap tend to be slightly higher than those covered with wax paper.

NOTES



1. More or less food than the quantity listed in the chart should be cooked following the guidelines in any microwave cookbook. Press the power level pad once or twice before pressing **START/enter**.
2. AUTO COOK can be programmed with MORE or LESS TIME ADJUSTMENT. See page 20.
3. The final cooking result will vary according to the food condition (e.g. initial temperature, shape, quality). Check food for temperature after heating. If additional time is needed, continue to heat manually.
4. Each food has a cooking hint. Press **user pref** pad when the HELP indicator is lighted in the display.

AUTO COOK CHART

FOOD	AMOUNT	PROCEDURE
1. Pizza	1 - 6 slices	Use this setting to reheat refrigerated leftover pizza. One slice is approximately 1/8 th of an 12-inch pizza or 1/16 th of a 16-inch pizza. if possible, place on paper towel on a microwave-safe rack. Press auto cook and the number 1 . Enter number of slices. Press START/enter .
2. Hot Dogs	1 - 6	Place hot dog in bun. Wrap each with paper towel or napkin. Press auto cook and the number 2 . Enter the quantity of hot dogs and press START/enter .
3. Beverage	0.5 - 2.0 cups	This setting is good for restoring cooled beverage to a better drinking temperature. Stir liquid briskly before and after heating to avoid "eruption". Press auto cook and the number 3 . Enter the quantity of cups and press START/enter .

CHICKEN NUGGETS

- Suppose you want to heat 0.3 pounds of chicken nuggets with snacks.

STEP	PRESS
1. Press chicken nugget pad.	
2. Enter amount by pressing the number 3 .	
3. Press START/enter .	

NOTE

When 1.0 pound chicken nuggets is heated, press number **1** and **0** at Step 2.

CHICKEN NUGGETS CHART

FOOD	AMOUNT	PROCEDURE
Chicken Nuggets	0.3 - 1.0 lb	Place frozen chicken nuggets on a flat plate allowing space between each, cover food with paper towel. Press chicken nugget pad. Enter weight and touch START/enter . After cooking, open door, rearrange, close door and press START/enter . Let stand, covered, for 1 to 3 minutes.



SETTING THE MICROWAVE OVEN

KEEP WARM

KEEP WARM allows you to keep food warm up to 30 minutes.

DIRECT USE

- Suppose you want to keep a cup of soup warm for 15 minutes.



STEP	PRESS
1. Press keep warm .	
2. Enter time 1,5,0,0 .	
3. Press START/enter .	

The microwave oven will start. The display will show 15.00 and count down. KEEP WARM will be displayed during the count down. You can program KEEP WARM with manual cooking to keep food warm continuously after cooking.

SNACK MENU

SNACK MENU automatically computes the correct heating time and microwave power level for foods shown in the chart below.

- Suppose you want to cook a 3 oz hand-held snack.





STEP	PRESS
Press snack menu .	
Press 1 for 3 - 4 oz hand-held snack.	
Press START/enter .	

SNACK MENU CHART

FOOD	AMOUNT	PROCEDURE
1. Hand-held Snacks	3 - 4 oz	Press snack menu pad and number 1 for hand-held snacks. Press START/enter .
2. Hand-held Snacks	5 - 6 oz	Press snack menu pad and number 2 for hand-held snacks. Press START/enter .
3. Frozen Kid's Meal	6 - 8 oz	Press snack menu pad and number 3 for frozen kid's meal. Press START/enter .

WITH MANUAL COOKING

- Suppose you want to cook a cup of soup for 2 minutes at 70% and keep the soup warm for 15 minutes.

STEP	PRESS
1. Enter cooking time 2,0,0 .	
2. Press power level pad 4 times for 70% power.	
3. Press keep warm pad.	
4. Enter time 1,5,0,0 .	
Press START/enter pad.	

The operation will start. When the cooking time is complete, a long tone will sound and KEEP WARM will start. The display will count down for 15 minutes and KEEP WARM will be displayed.

NOTE

KEEP WARM cannot be programmed with CONVENIENT FEATURES.

NOTE





SNACK MENU can be programmed with MORE or LESS TIME ADJUSTMENT. See page 20.

SETTING THE MICROWAVE OVEN

MELT/SOFTEN

MELT/SOFTEN automatically computes the correct heating time and microwave power level for melting and softening foods shown in the chart below.

- Suppose you want to soften 2 tablespoons of butter.

STEP	PRESS
1. Press melt/soften and 1 for butter.	 
2. Press 1 for 2 tablespoons.	
3. Press START/enter .	

NOTES

1. MELT/SOFTEN can be programmed with MORE OR LESS TIME ADJUSTMENT. See page 20.
2. To melt or soften other foods above or below the quantity allowed on the MELT/SOFTEN Chart, use manual operation.

MELT/SOFTEN CHART

FOOD	AMOUNT	PROCEDURE
MELT		
1. Butter	2 tbsp 1/2 cup	Use a Pyrex measuring cup. Cover with plastic wrap. After pressing melt , press number 1 once for 2 tbsp. After pressing melt , press number 1 twice for 1/2 cup.
2. Chocolate	1 cup chips 1 square	After pressing melt , press number 2 once for 1 cup chips. After pressing melt , press number 2 twice for 1 square.
SOFTEN		
3. Ice Cream	1 pint 1/2 gallon	DO NOT COVER. After pressing soften , press number 3 once for 1 pint. After pressing soften , press number 3 twice for 1/2 gallon.
4. Cream Cheese	3 oz 8 oz	After pressing soften , press number 4 once for 3 oz. After pressing soften , press number 4 twice for 8 oz.

SETTING THE MICROWAVE OVEN

USER PREFERENCE

USER PREF provides 5 features that make using your microwave oven easy because specific instructions are provided in the interactive display.

1. Child Lock

The Child Lock prevents unwanted oven operation such as by small children. The oven can be set so that the control panel is deactivated or locked. To set, press **user pref**, the number **1** and then press the **START/enter** pad. Should a pad be touched, LOCKED will appear in the display. To cancel, press **user pref** and **START/enter** pad.





2. Audible Signal Elimination

If you wish to have the microwave oven operate with no audible signals, press **user pref**, the number **2** and then press the **STOP/clear** pad. To cancel, press **user pref** and **START/enter** pad.

3. Auto Start

If you wish to program your microwave oven to begin cooking automatically at a designated time of day, follow this procedure:

- Suppose you want to start cooking a stew for 40 minutes on 50% at 4:30. Before setting, check to make sure the clock is showing the correct time of day.

STEP	PRESS
1. Press user pref and the number 3 .	 3
2. Enter number 4,3,0 for start time.	4 3 0
3. Press START/enter .	
4. Enter cook time. 4,0,0,0 .	4 0 0 0
5. Press power level pad six times for 50% power.	 x 6
6. Press START/enter or power level .	

NOTES

1. AUTO START can be used for manual cooking if clock is set.
2. If the microwave oven door is opened after programming AUTO START, it is necessary to press the **START/enter** pad for AUTO START time to appear in the readout so that the microwave oven will automatically begin programmed cooking at the chosen AUTO START time.
3. Be sure to choose foods that can be left in the microwave oven safely until the AUTO START time. Acorn or butternut squash are often a good choice.



4. Language / Weight Selection

The microwave oven comes set for English and U.S. Customary Unit-pounds. To change, press **user pref** and the number **4**. Press the number **4** until your choice is selected from the table below. Then, press **START/enter**.

Press user pref and the number 4	Language	Units
once	English	LB
twice	English	KG
3 times	Spanish	LB
4 times	Spanish	KG
5 times	French	LB
6 times	French	KG

5. To Set the Clock

- Suppose you want to enter the correct time of day, 12:30 (AM or PM).

STEP	PRESS
1. Press user pref and the number 5 .	 5
2. Enter time 1, 2, 3, 0 .	1 2 3 0
3. Press START/enter .	

This is a 12 hour clock. If you attempt to enter an incorrect clock time, ERROR will appear in the display. Press **STOP/clear** and re-enter the time.

SETTING THE MICROWAVE OVEN

HELP (In display)

Whenever HELP is lighted in the Interactive Display, press **user pref** to read cooking and operating hints.

MULTIPLE SEQUENCE COOKING

Your microwave oven can be programmed for up to 4 automatic cooking sequences, switching from one power level setting to another automatically.

Sometimes cooking directions tell you to start on one power level and then change to a different power level. Your microwave oven can do this automatically.

- Suppose you want to cook roast beef for 5 minutes at 100% and then continue to cook for 30 minutes at 50%.

STEP	PRESS
1. First enter cooking time. Then press power level pad once for 100% power.	 5 0 0 power level
2. Enter second cooking time. Press power level pad 6 times for 50% power.	 3 0 0 0 power level x 6
3. Press START/enter .	 START enter

NOTES

1. If you wish to know power level, simply press the **power level** pad. As long as your finger is pressing the **power level** pad, the power level will be displayed.
2. If 100% is selected as the final sequence, it is not necessary to press the **power level** pad.

ADD 30 SEC

ADD 30 SEC allows you to cook for 30 seconds at 100% by simply pressing the **add 30 sec** pad. You can also extend cooking time in multiples of 30 seconds by repeatedly pressing the **add 30 sec** pad during manual cooking.

NOTES

1. To use **add 30 sec**, press pad within 3 minutes after cooking, closing the door, pressing the **STOP/clear** pad or during cooking.
2. ADD 30 SEC cannot be used with SENSOR COOKING or AUTO COOKING.

QUICK START

QUICK START is a short-cut method to set time for 1-6 minutes at power level 10.

- Suppose you want to heat a cup of soup for two minutes.

STEP	PRESS
Press number 2 pad.	 2

The oven will start immediately and will signal then turn off automatically when finished.

NOTE

To use **quick start**, press pads within 3 minutes after cooking, closing the door, pressing the **STOP/clear** pad or during cooking.

DEMONSTRATION MODE

To demonstrate, press **user pref**, the number **5**, the number **0** and then press **START/enter** and hold for three seconds. DEMO ON will appear in the display. Cooking operations and specific special features can now be demonstrated with no power in the oven. For example, press **add 30 sec** pad and the display will show :30 and count down quickly to END.

To cancel, press **user pref**, the number **5**, the number **0** and then **STOP/clear** pads. If easier, unplug the oven from the electrical outlet and replug and set clock.

MORE OR LESS TIME ADJUSTMENT

Should you discover that you like any of the SENSOR COOKING or AUTO COOKING settings slightly **more** done, press the **power level** pad once after pressing your choice of pads. The display will show MORE.

For slightly **less** done, press the **power level** pad twice after pressing your choice of pads. The display will show LESS.

TIMER ON/OFF

- Suppose you want to time a 3 minute long distance phone call.

STEP	PRESS
Press timer on/off pad.	 timer on-off
Press 3,0,0 to enter time.	 3 0 0
Press timer on/off pad. The timer will count down. To cancel the timer, press the STOP/clear pad once.	 timer on-off

BEFORE SETTING OVEN CONTROLS

OVEN VENT LOCATION

The oven is vented **as shown**. When the oven is on, warm air is released through the vent. This venting is necessary for proper air circulation in the oven and good baking results.

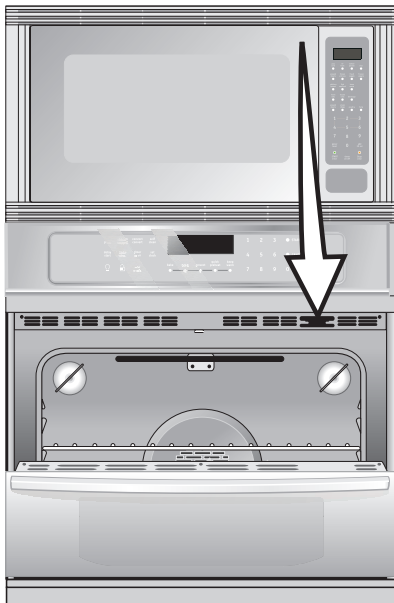

ARRANGING OVEN RACKS

ALWAYS ARRANGE OVEN RACKS WHEN THE OVEN IS COOL (PRIOR TO OPERATING THE OVEN). Always use oven mitts when using the oven.

To remove an oven rack, pull the rack forward until it stops. Lift up front of rack and slide out.

To replace an oven rack, fit the rack onto the guides on the oven walls. Tilt the front of the rack upward and slide the rack back into place.

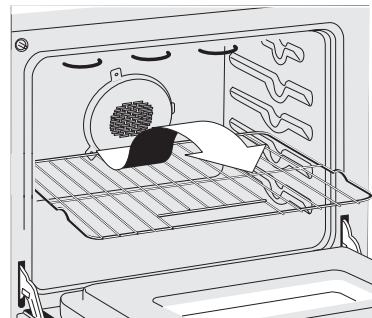

RECOMMENDED RACK POSITION

Food	Rack Position	
Broiling meats, chicken or fish	3 or 4	
Cookies, cakes, pies, biscuits & muffins	Using a single rack	2 or 3
	Using two racks	2 and 4
	Using multiple racks	1, 3(offset), 4
Frozen pies, angel food cake, yeast, bread, 1 or 2 casseroles, small cuts of meat or poultry	1 or 2	
Turkey, roast or ham	1 or Offset Rack	

CAUTION

Some models are equipped with a blower which runs in baking and self-cleaning mode to keep all internal components at a cool temperature. The blower may keep running even if the oven has been turned off, until the components have cooled down.

AIR CIRCULATION IN THE OVEN

If using 1 rack, place in center of oven. If using multiple racks, stagger cookware as shown.

For best air circulation and baking results allow 2" to 4" around the cookware for proper air circulation and be sure pans and cookware do not touch each other, the oven door, sides or back of the oven cavity. The hot air must circulate around the pans and cookware in the oven for even heat to reach around the food.

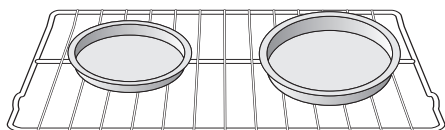

Single Oven Rack

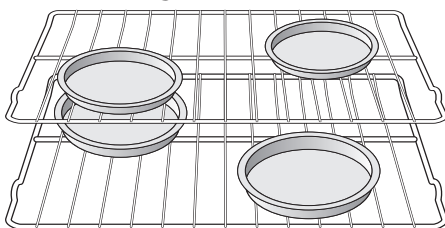

Multiple Oven Racks

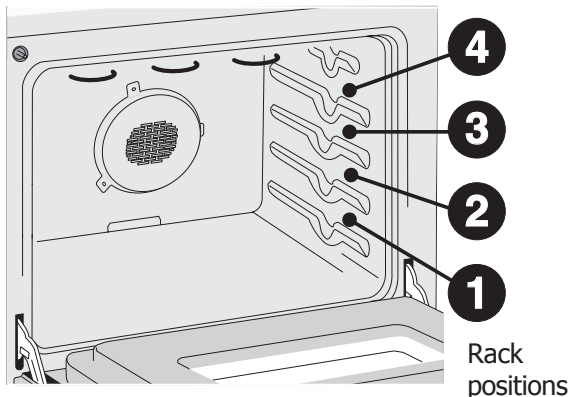

Rack positions

NOTE

The features shown for your appliance may vary according to model type & color.

Always use caution when removing food from the oven.

BEFORE SETTING OVEN CONTROLS

TYPES OF OVEN RACKS

Your appliance may be equipped with three types of the oven rack, as shown;

- **Flat Handle Oven Rack** (Figure 1).
- **Flat Oven Half Rack** (Figure 2 & 3) (some models).
- **Offset Oven Rack** (Figure 4).

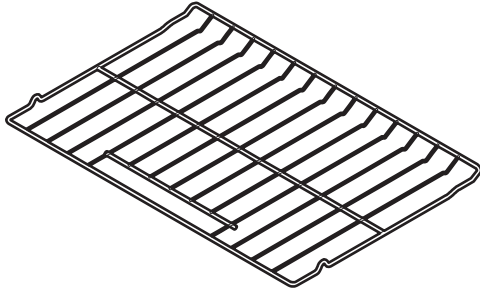

Flat Handle Oven Rack
Figure 1

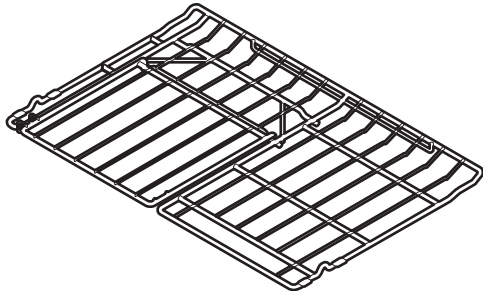

Flat Half Oven Rack - Closed Position
Figure 2

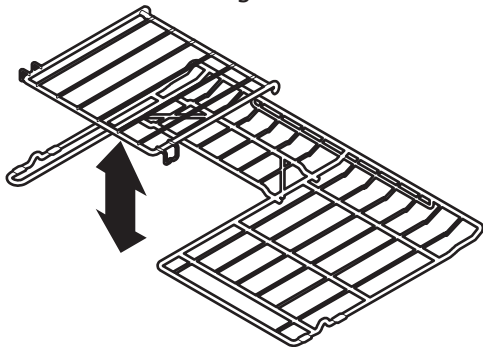

Flat Half Oven Rack - Open Position
Figure 3

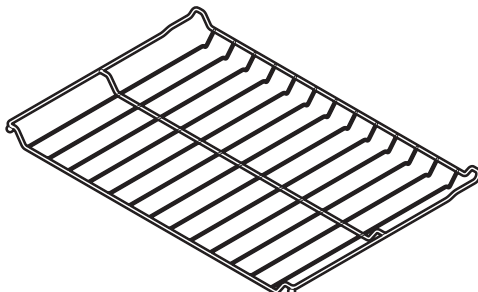

Offset Oven Rack
Figure 4

CAUTION

Always use pot holders or oven mitts when adjusting the oven racks. Wait until the oven has completely cooled if possible. Oven racks may be HOT and may cause burns.

The **Flat Oven Handle Rack** has an handle to facilitate the sliding of the rack when large amount of foods weight on it.

The **Flat Oven Half Rack** (some models) has a removable insert that can provide extra space for larger food items. The right half rack portion may still be used for other food items like a casserole dish (See Figure 3 & 4). To remove the insert, squeeze on the left front insert side (See Figure 5) of the rack and tilt out clockwise. To reinstall, insert rear hooks at back of insert (See figure 6) and lay insert down. Make sure both insert front hooks snap into rack (See figure 6).

The **Offset Oven Rack** is used to maximize cooking space (See Figure 4). The offset rack can be used in the lower rack position to roast large cuts of meat and poultry.

Do not use cookware that extends beyond the edge of the Flat Half Rack. For best results, allow 2 inches between the pan placed on the rack and oven side or rear walls.



Figure 5

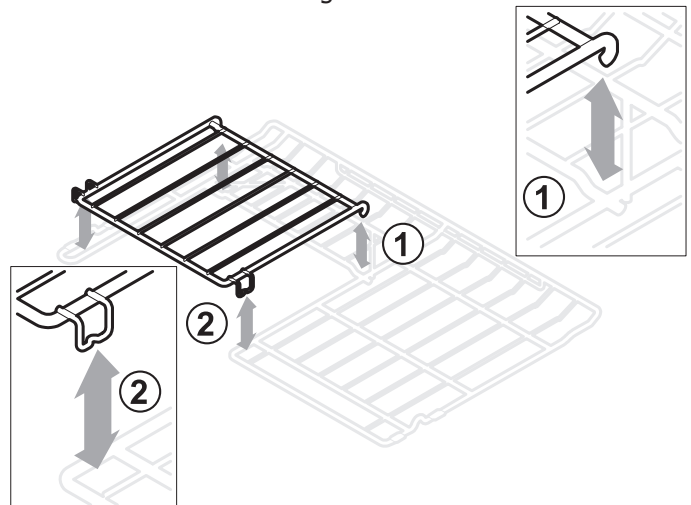

Figure 6

BEFORE SETTING OVEN CONTROLS

CONTROL PAD FEATURES

READ THE INSTRUCTIONS CAREFULLY BEFORE USING THE OVEN. For satisfactory use of your oven, become familiar with the various features and functions of the oven as described below. **Detailed instructions for each feature and function follow later in this Use & Care Guide.**

- 1. PIZZA PAD**—Use to select the pizza cooking feature.
- 2. CHICKEN NUGGETS PAD**—Use to select the chicken nuggets cooking feature.
- 3. CONVECTION CONVERT PAD**—Use to convert a regular recipe temperature to a convection temperature.

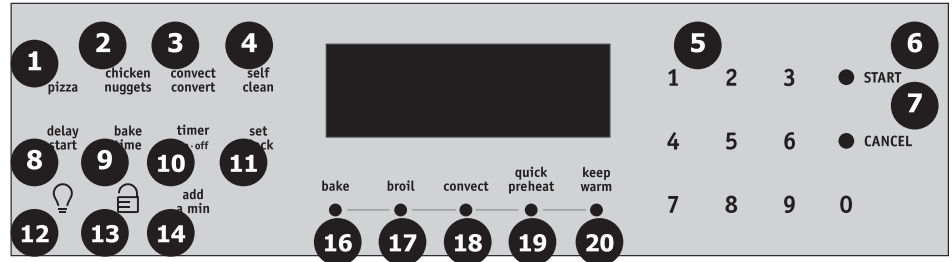

MODEL A

- 4. SELF CLEAN PAD**—Use to select the self cleaning feature.
- 5. NUMERIC PAD**—Use to enter temperatures and times.
- 6. START PAD**—Use to start all oven cooking features.
- 7. CANCEL PAD**—Use to cancel any oven feature previously entered except the time of day and minute timer.

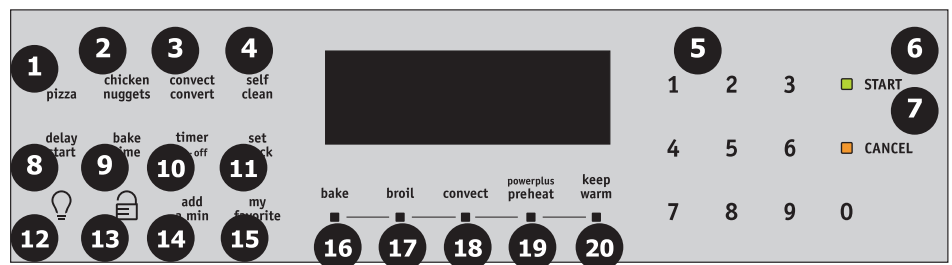

MODEL B

- 8. DELAY START PAD**—Use to program a Delayed Timed Bake or Delay Self-Cleaning cycle start time.
- 9. BAKE TIME PAD**—Use to enter the length of the baking time.
- 10. TIMER ON-OFF PAD**—Use to set or cancel the Minute Timer. The Minute Timer does not start or stop cooking.
- 11. SET CLOCK PAD**—Use to set the time of day.
- 12. OVEN LIGHT PAD**—Use to turn the oven light ON and OFF.
- 13. OVEN LOCKOUT PAD**—Use to lock the oven door and the control panel pads.
- 14. ADD A MINUTE PAD**—Use to add a minute to the Timer feature.

- 15. MY FAVORITE PAD (some models)**—Use to record a temperature setting for a cooking feature.
- 16. BAKE PAD**—Use to select the bake cooking feature.
- 17. BROIL PAD**—Use to select the broil cooking feature.
- 18. CONVECT PAD**—Use to select between the Convection Bake, Convection Roast and Convection Broil cooking features.
- 19. QUICK PREHEAT OR POWER PLUS PREHEAT PAD**—Use to quickly raise oven to cooking temperature.
- 20. KEEP WARM PAD**—Use to keep the dishes and food warm until served.

IMPORTANT THINGS TO KNOW BEFORE SETTING ANY OVEN COOKING FEATURE

This appliance has been factory pre-set to start any **BAKE, CONVECTION BAKE, CONVECTION ROAST** or **PREHEAT** feature with the oven set temperature automatically set for 350°F. The **BROIL** or **CONVECTION BROIL** features are pre-set at 550°F. However if desired, the oven set temperature may be adjusted at any time during the cooking process. You may also choose to add a **BAKE TIME** or **DELAY START** with most of the functions listed above, unless specified in their corresponding section.

TEMPERATURE VISUAL DISPLAY

Your oven is equipped with a temperature visual display. When a cooking mode is set, the actual temperature will be shown in the display and will rise as the unit preheat. When the unit has reached its target temperature, a chime will sound to remind you to place the food in the oven. This feature will be active with some cooking modes; **BAKE, CONVECTION BAKE, CONVECTION ROAST** and **PIZZA**.

NOTE

The lowest temperature that can be displayed is 100°F.

SETTING OVEN CONTROLS

MINIMUM AND MAXIMUM CONTROL PAD SETTINGS

All of the features listed below have minimum and maximum time or temperature settings that may be entered into the control. An ENTRY acceptance beep will sound each time a control pad is touched (the acceptance beep on the Oven Lockout pad is delayed 3 seconds).

An ENTRY ERROR tone (3 short beeps) will sound if the entry of the temperature or time is below the minimum or above the maximum settings for the feature.

FEATURE		MINIMUM TEMP. /TIME	MAXIMUM TEMP. /TIME
PREHEAT		170°F/77°C	550°F/288°C
BAKE		170°F/77°C	550°F/288°C
BROIL		400°F/205°C	550°F/288°C
CONVECTION BAKE		170°F/77°C	550°F/288°C
CONVECTION ROAST		170°F/77°C	550°F/288°C
CONVECTION BROIL		400°F/205°C	550°F/288°C
PIZZA		170°F/77°C	550°F/288°C
CHICKEN NUGGETS		170°F/77°C	550°F/288°C
TIMER	12 Hr. Mode	0:01 Min.	11:59 Hr./Min.
	24 Hr. Mode	0:01 Min.	11:59 Hr./Min.
CLOCK TIME	12 Hr. Mode	1:00 Hr./Min.	12:59 Hr./Min.
	24 Hr. Mode	0:00 Hr./Min.	23:59 Hr./Min.
DELAY START	12 Hr. Mode	1:00 Hr./Min.	12:59 Hr./Min.
	24 Hr. Mode	0:00 Hr./Min.	23:59 Hr./Min.
BAKE TIME	12 Hr. Mode	0:01 Min.	5:59 Hr./Min.
	24 Hr. Mode	0:01 Min.	5:59 Hr./Min.
SELF CLEAN TIME		2 hours	4 hours

SETTING THE CLOCK

The **SET CLOCK** pad is used to set the clock. The clock may be set for 12 or 24 hour time of day operation. The clock has been preset at the factory for the 12 hour operation. When the range is first plugged in, or when the power supply to the range has been interrupted, the timer in the display will flash.

To set the clock (example below for 1:30)

1. Press **SET CLOCK**. "CLO" will appear in the display.
2. Press **1 3 0** pads to set the time of day to 1:30. "CLO" will stay in the display.
3. Press **START**. "CLO" will disappear and the clock will start.

CHANGING BETWEEN 12 OR 24 HOUR TIME OF DAY DISPLAY

1. Press and hold **SET CLOCK** for 6 seconds. "CLO" will appear in the display.
2. **CONTINUE** holding the pad until "12Hr dAY" or "24Hr dAY" appears in the display and the control beeps once.
3. Press **SELF CLEAN** to switch between the 12 and 24 hour time of day display. The display will show either "12Hr dAY" or "24Hr dAY".
4. Press **START** to accept the change or press **CANCEL** to reject the change.
5. Reset the correct time as described in **To set the Clock** above. Please note that if the 24 hour time of day mode was chosen, the clock will now display time from 0:00 through 23:59 hours.

SETTING CONTINUOUS BAKE OR 6 HOUR ENERGY SAVING

The **TIMER** and **SELF CLEAN** pads control the Continuous Bake or 6 Hour Energy Saving features. The oven control has a factory preset built-in 6 Hour Energy Saving feature that will shut off the oven if the oven control is left on for more than 6 hours. The oven can be programmed to override this feature for Continuous Baking.

To set the control for Continuous Bake or 6 Hour Energy Saving features

1. Press and hold **TIMER** for 6 seconds. After 6 seconds "**6Hr OFF**" or "**StAY On**" will appear in the display and the control will beep once.
2. Press **SELF CLEAN** to switch between the 6 Hour Energy Saving and continuous bake features.

Note: "**6Hr OFF**" in the display indicates the control is set for the 6 Hour Energy Saving mode and "**StAY On**" indicates the control is set for the Continuous Bake feature.

3. Press **START** to accept the change (display will return to time of day) or press **CANCEL** to reject the change.

SETTING TEMPERATURE DISPLAY — FAHRENHEIT OR CELSIUS:

The **BROIL** and **SELF CLEAN** pads control the Fahrenheit or Celsius temperature display modes. The oven control can be programmed to display temperatures in Fahrenheit or Celsius. The oven has been preset at the factory to display in Fahrenheit.

To change display from Fahrenheit to Celsius or Celsius to Fahrenheit

1. To tell if the display is set for Fahrenheit or Celsius press **BROIL** and hold it for 6 seconds; "**550°**" will appear and "**BROIL**" will flash in the display and a beep will sound. If "**FAhrnht**" appears, the display is set to show temperatures in Fahrenheit. If "**CELSIUS**" appears, the display is set to show temperatures in Celsius.
2. Press **SELF CLEAN** to switch between Fahrenheit or Celsius display modes. The display will show either "**FAhrnht**" or "**CELSIUS**".
3. Press **START** to accept the change or press **CANCEL** to reject the change.

SETTING SILENT CONTROL OPERATION

The **DELAY START** and **SELF CLEAN** pads control the Silent Control operation feature. The Silent Control operation feature allows the oven control to be operated without sounds or beeps whenever necessary. If desired the control can be programmed for silent operation and later returned to operating with all the normal sounds and beeps.

To change control from normal sound operation to silent control operation

1. To tell if your range is set for normal or silent operation press and hold **DELAY START**. "-- --" will appear and "**DELAY**" will flash in the display. After 6 seconds "**bEEP On**" or "**bEEP OFF**" will appear in the display.
2. Press **SELF CLEAN** to switch between normal sound operation and silent operation mode. The display will show either "**bEEP On**" or "**bEEP OFF**".

Note: If "**bEEP On**" appears, the control will operate with normal sounds and beeps. If "**bEEP OFF**" appears, the control is in the silent operation mode.

3. Press **START** to accept the change or press **CANCEL** to reject the change.

Note: The control will always beep at the end of a minute timer and will beep when a set temperature has been reached, even if the control is set to silent operation.

SETTING OVEN CONTROLS

SETTING MINUTE TIMER

The **TIMER ON-OFF** pad controls the Minute Timer feature. The Minute Timer serves as an extra timer in the kitchen that will beep when the set time has run out. It does not start or stop cooking. The Minute Timer feature can be used during any of the other oven control functions. Refer to "Minimum and Maximum Control Pad Settings" for time amount settings.

To set the Minute Timer (example for 5 minutes)

1. Press **TIMER ON-OFF**. "-- --" will appear and **"Timer"** will flash in the display.
2. Press the number pads to set the desired time in the display.
3. Press **START**. The time will begin to count down with **"5:00"** and **"Timer"** will stay in the display.

Note: If **START** is not pressed the timer will return to the time of day after 25 seconds.

4. When the set time has run out, **"End"** and **"Timer"** will show in the display. The clock will sound with 3 beeps every 5 seconds until **TIMER ON-OFF** is pressed.

To cancel the Minute Timer before the set time has run out

1. Press **TIMER ON-OFF**. The display will return to the time of day.



SETTING ADD 1 MINUTE FEATURE

The **ADD 1 MINUTE** pad is used to set the Add 1 Minute feature. When the **ADD 1 MINUTE** pad is pressed, 1 minute is added to the Minute Timer feature if this feature is already active. If the Minute Timer feature is not active and the **ADD 1 MINUTE** pad is pressed, the Minute Timer feature will become active and will begin counting down from 1 minute.



SETTING OVEN LOCKOUT FEATURE

The  pad controls the Oven Lockout feature. The Oven Lockout feature automatically locks the oven door and prevents the oven from being turned on. It does not disable the Minute Timer or the interior oven lights.

To activate the Oven Lockout feature

1. Press and hold  for 3 seconds.
2. After 3 seconds **"door Loc"** will appear, a beep will sound and **"DOOR"** and  will flash in the display. Once the oven door is locked the **"DOOR"** and  indicators will stop flashing and remain on along with the **"Loc"**.

To reactivate normal oven operation:

1. Press and hold  for 3 seconds. After 3 seconds **"door OPn"** will appear and a beep will sound. The **"DOOR"** and  will flash in the display until the oven door has completely unlocked
2. The oven is again fully operational.

SETTING OVEN CONTROLS

SETTING QUICK OR POWER PLUS PREHEAT

The **QUICK OR POWER PLUS PREHEAT** pad controls the Preheat feature. The Preheat feature will bring the oven up to temperature and then indicate when to place the food in the oven. Use this feature when recipes call for preheating. Preheating is not necessary when roasting or cooking casseroles. The oven can be programmed to preheat at any temperature between 170°F to 550°F.

To set the Preheat temperature for 375°F

1. Arrange the interior oven racks.
2. Press **QUICK OR POWER PLUS PREHEAT**. "350" will appear in the display. If a preheat of 350°F is needed, press **START**.
3. Press **3 7 5**.
4. Press **START**. "PRE" will be displayed while the oven is preheating.
5. Press **CANCEL** when baking is complete or to cancel the preheat feature.

NOTE

After the oven has reached the desired temperature (this example, 375°F) the control will beep and the "PRE" light will turn off, the BAKE feature will activate and oven target temperature will be displayed. If you missed hearing the beep, you can tell that the oven has reached preheat temperature if you see the oven temperature showing in the oven display. Once the oven has preheated, **place food in the oven**. The preheat temperature can only be changed while the "PRE" message is displayed.

To change Preheat temperature while oven is preheating (ex: changing from 375°F to 425°F)

If it is necessary to change the preheat temperature while the oven is preheating to the original temperature:

1. While preheating, press **QUICK OR POWER PLUS PREHEAT**. "375" will appear in the display.
2. Enter the new preheat temperature. Press **4 2 5**.
3. Press **START**. "PRE" will be shown in the display.

Note: A beep will sound once the oven temperature reaches 425°F and the display will show "425°".

4. When baking is complete press **CANCEL**.

NOTE

While in preheat mode, the convection fan will be activated during the first rise of temperature to allow the oven to reach its target temperature faster. The Bake, Broil and Convection elements will also cycle for a better heat distribution.

SETTING BAKE

The **BAKE** pad controls normal baking. If a rapid preheating is preferred, refer to the **PREHEAT** feature for instructions. The oven can be programmed to bake at any temperature from 170°F to 550°F.

Baking Tips:

- Preheat your oven before using the bake mode.
- During preheat, the 3 elements and the convection fan are used in cycle to quickly heat the oven.
- Use only one rack and center the pans as much as possible on rack 2 or 3.
- If using two racks, place the oven racks in positions 2 and 4.
- Allow 2" to 4" around the utensil(s) for proper air circulation.
- Be sure the pans do not touch each other, the door, sides or back of the oven.

To set the Bake Temperature to 375°F

1. Arrange interior oven racks.
2. Press **BAKE**, "350" will appear in the display. If a bake of 350°F is needed, press **START**.
3. Press **3 7 5**.
4. Press **START**. The actual temperature will be displayed. A beep will sound once the oven temperature reaches 375°F and the display will show "375°".
5. Place food in the oven.

NOTE

Pressing **CANCEL** will stop the feature at any time.

To change the Bake Temperature (example: changing from 375°F to 425°F)

1. After the oven has already been set to bake at 375°F and the oven temperature needs to be changed to 425°F, press **BAKE** and "375" will appear in the display.
2. Press **4 2 5**.
3. Press **START**.

NOTE

During the first rise of temperature, the convection fan will be activated to allow the oven to reach its target temperature faster. The Bake, Broil and Convection elements will also cycle for a better heat distribution.

SETTING OVEN CONTROLS

SETTING CONVECTION BAKE

This mode of cooking enables you to obtain the best culinary results when baking with multiple pans and racks. Multiple rack baking may slightly increase cook time for some foods but the overall result is time saved. Some food may cook faster and more evenly with Convection Bake. Convection baking uses the three elements and a fan to circulate the oven's heat evenly and continuously within the oven. The oven can be programmed for Convection baking at any temperature between 170°F to 550°F with a default temperature of 350°F.

Convection Baking Tips:

- Always preheat your oven before using the Convection Bake mode.
- During preheat, the 3 elements and the convection fan are used in cycle to quickly heat the oven.
- If your recipe cooking temperature has already been converted for convection baking there is no need to reduce your oven temperature. If your recipe has not had the temperature converted for convection baking you can easily reduce using the Convection Convert feature. Please see Convection Convert section on next page for further instruction on temperature conversion.
- Use tested recipes with times adjusted for convection baking when using this mode. Time reductions will vary depending on the amount and type of food to be cooked.
- When using Convection Bake with a single rack, place oven rack in position 2 or 3. If cooking on multiple racks, place the oven racks in positions 2 and 4 or 1, 3 (offset rack) and 4.
- Most bakeries (except cakes) should be baked on pans with no sides or very low sides to allow heated air to circulate around the food.
- Food baked on pans with a dark finish will cook faster.

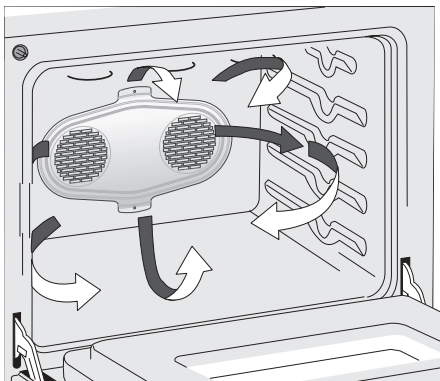

Air circulation during Convection Bake
Figure 1

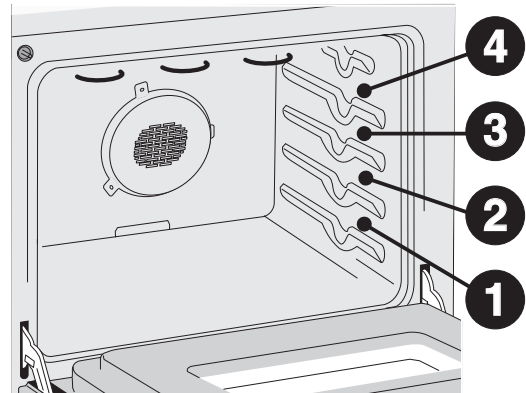

Oven Rack Positions
Figure 2

To set the oven for Convection Bake and temperature to 375°F

1. Arrange interior oven racks.
2. Press **CONVECT**. "**CONVECT**" and "**BAKE**" will flash and "**350**" will appear in the display. If a Convection Bake of 350°F is needed, press **START**.
3. Press **3 7 5**. "**CONVECT**" and "**BAKE**" will keep flashing and "**375°**" will appear in the display.
4. Press **START**. The actual oven temperature and the fan icon will be displayed. A beep will sound once the oven temperature reaches 375°F and the display will show "**375°**", "**CONVECT**", "**BAKE**" and the fan icon.
5. Place food in the oven.

NOTE

Pressing **CANCEL** will stop the feature at any time.

Benefits of Convection Bake:

- Multiple rack baking.
- Some foods cook faster, saving time and energy.
- No special pans or bakeware needed.

NOTE

The convection fan will start **AS SOON AS** the oven is set for Convection Bake. The display will show an icon of rotating fan within a square. This rotating fan icon indicates when the Convection Fan is operating. The Bake, Broil and Convection elements will also cycle for a better heat distribution.

NOTE

The features shown for your appliance may vary according to model type & color.

SETTING OVEN CONTROLS

SETTING CONVECTION CONVERT

The Convection Convert pad is used to automatically convert a standard baking recipe for convection baking. When set properly, this feature is designed to display the actual converted (reduced) temperature in the display. Convection Convert may ONLY be used with a Convection Bake cooking mode. It can be used with the features Delay Start and Bake Time (see their sections for directions). If convection conversion is used with the Bake Time and Delay Start features, "CF" (check food) will be displayed when 75% of the bake time complete. At this time the oven control will sound 3 long beeps at regular intervals until baking had finished. When the bake time has completely finished the control will display "End" and beep at regular interval until the **CANCEL** pad is pressed.

NOTE

To use this feature with the **BAKE TIME** option, the **BAKE TIME** pad must be pressed before the **CONVECTION CONVERT** pad.

To set the oven for Convection Bake with a standard baking recipe temperature of 400°F:

1. Arrange interior oven racks.
2. Press **CONVECT**. "CONVECT" and "BAKE" will flash and "350" will appear in the display.
3. Press **4 0 0**. "CONVECT" and "BAKE" will keep flashing and "400°" will appear in the display.
4. Press **CONVECTION CONVERT**. As soon as the convection convert pad is pressed, the oven will start heating. The temperature displayed will be 25°F lower than what it used to be. The actual oven temperature and the fan icon will be displayed. A beep will sound once the oven temperature reaches 375°F and the display will show "375°", "CONVECT", "BAKE" and the fan icon.
5. Place food in the oven.

NOTE

When using a Bake Time under 20 minutes, the Convection Convert will not beep and display the "CF" message.

SETTING CONVECTION ROAST

This mode is best for cooking tender cuts of beef, lamb, park and poultry. Use this mode when cooking speed is desired. The Convection Roasting gently browns the exterior and seals in the juices. Convection roasting uses the hidden bake element, the hidden convection element, the broil element and a fan to circulate the oven's heat evenly and continuously within the oven. The oven can be programmed for Convection Roasting at any temperature between 170°F to 550°F with a default temperature of 350°F.

Convection Roasting Tips:

- Use a broiler pan and grid, and a roasting rack (available by mail order). The broiler pan will catch grease spills and the grid will help prevent spatters. The roasting rack will hold the meat.
- Place an oven rack on rack position 1 (offset rack).
- No preheat is needed in convection roast.
- Make sure the roasting rack is securely seated on the grid in the broiler pan. The roasting rack fits on the grid allowing the heated air to circulate under the food for even cooking and helps to increase browning on the underside (available by mail order only).
- There is no need to reduce the convection temperature or to use the Convection Convert feature with this cooking mode.
- **DO NOT** use the broiler pan without the grid or cover the grid with aluminum foil (available by mail order).
- Always pull the rack out to the stop position before removing food.
- Position food (fat side up) on the roasting rack.

To set a Convection Roast Temperature of 375°F:

1. Arrange oven racks and place food in the oven.
2. Press **CONVECT**; "350" will be displayed; "CONVECT" and "BAKE" will flash.
3. Press **CONVECT** again; "350" will be displayed; "CONVECT" and "ROAST" will flash.
4. Enter the desired roasting temperature using the number pads **3 7 5**.
5. Press **START**; The actual oven temperature will be displayed, "CONVECT", "ROAST" and the fan icon will be displayed. The Bake, Broil and Convection elements will also cycle for a better heat distribution.

NOTE

Pressing **CANCEL** will stop the feature at any time.

NOTE

The Bake, Broil and Convection elements will cycle for a better heat distribution.

SETTING OVEN CONTROLS

SETTING CONVECTION BROIL

Use this mode for thicker cuts of meat, fish and poultry. The Convection Broiling gently browns the exterior and seals in the juices. Convection broiling uses the broil element and a fan to circulate the oven's heat evenly and continuously within the oven. The oven can be programmed for Convection Broiling at any temperature between 300°F to 550°F with a default temperature of 550°F.

Convection Broiling Tips:

- For optimum browning, preheat the broil element for 5 minutes.
- Broil one side until the food is browned; turn and cook on the second side. Season and serve.
- Always pull the rack out to the "stop" position before turning or removing food.
- Always use a broiler pan and its grid when broiling (available by mail order). It allows the dripping grease to be kept away from the high heat of the broil element.
- **DO NOT** use the broil pan without the insert (available by mail order). **DO NOT cover the broil pan insert with foil.** The exposed grease could catch fire.
- If using a Searing Grill (available by mail order), preheat the grill for 5 to 10 minutes before placing your meat.
- Convection broiling is generally faster than conventional broiling. Check for doneness at the minimum recommended time.

WARNING

Should an oven fire occur, leave the oven door closed and turn off the oven. If the fire continues, throw baking soda on the fire or use a fire extinguisher. **DO NOT** put water or flour on the fire. Flour may be explosive and water can cause a grease fire to spread and cause personal injury.

To set a Convection Broil Temperature of 500°F:

1. Arrange oven racks.
2. Press **CONVECT**; "350" will be displayed; "CONVECT" and "BAKE" will flash.
3. Press **CONVECT** again; "350" will be displayed; "CONVECT" and "ROAST" will flash.
4. Press **CONVECT** again; "550" will be displayed; "CONVECT" and "BROIL" will flash.
5. Enter the desired roasting temperature using the number pads **5 0 0**.
6. Press **START**; "550", "CONVECT", "BROIL" and the fan icon will be displayed.
7. After **5** minutes of preheat, place food in the oven.

NOTE

Pressing **CANCEL** will stop the feature at any time.

Accessories available via the enclosed brochure:

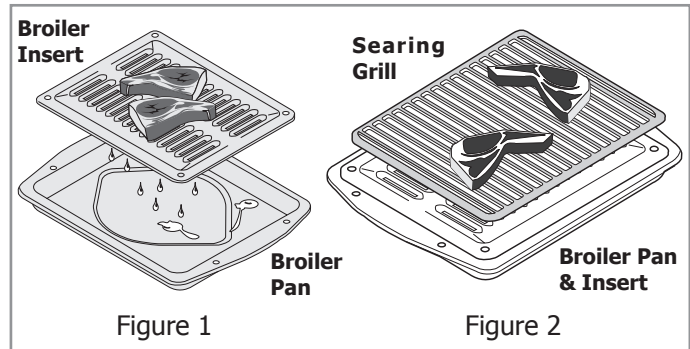

CAUTION

Always use this cooking mode with the oven door **closed** or the convection fan will not turn on.

Electric Oven Convection Broiling Table Recommendations

Food Item	Rack Position	Temperature Setting	Cook Time		Doneness
			1st side	2nd side	
Steak 1" thick	3rd or 4th	550° F	6:00	4:00	Rare
	3rd or 4th	550° F	7:00	5:00	Medium
Pork Chops 3/4" thick	3rd or 4th	550° F	8:00	6:00	Well
Chicken - Bone In	3rd	450° F	20:00	10:00	Well
Chicken - Boneless	3rd or 4th	450° F	8:00	6:00	Well
Fish	3rd	500° F	13:00	-	Well
Shrimp	3rd	550° F	5:00	-	Well
Hamburger 1" thick	3rd or 4th	550° F	9:00	7:00	Medium
	3rd or 4th	550° F	10:00	8:00	Well

SETTING OVEN CONTROLS

SETTING BAKE TIME

Bake Time allows the oven to be set to cook for a specific length of time and shut off automatically.

The oven will shut off and will beep when the countdown is finished. This feature can be used with Bake, Convection Bake, Convection Roast, Pizza and Chicken Nuggets cooking modes.

To program the oven to begin baking immediately and to shut off automatically (example: BAKE at 350°F for 30 minutes):

1. Be sure the clock is set for the correct time of day.
2. Arrange interior oven rack(s) and place the food in the oven.
3. Press **BAKE**, "350" will appear in the display.
4. Press **START**. The actual oven temperature will appear in the display.
5. Press **BAKE TIME**. "-- --" will appear in the display.
6. Enter the desired baking time by pressing **3 0**.
7. Press **START**. Once the Timed Bake feature has started, the current time of day will appear in the display.

NOTE

Baking time can be set for any amount of time between 1 minute to 6 hours. The time remaining can be shown in the timer section of the display by pressing **BAKE TIME** at any moment of the cooking.

Press **CANCEL** when baking has finished or at any time to cancel the Timed Bake feature. A Bake Time of "0" minute can also be entered to cancel the Bake Time feature and keep the oven in its current cooking mode.

NOTE

After the Timed Bake feature has activated, press **BAKE TIME** to display the bake time remaining in the Bake Time mode. Once Bake Time has started baking, a beep will sound when the oven temperature reaches the set temperature.

When the timed bake finishes:

1. "End" and the time of day will show in display. The oven will shut off automatically.
2. The control will beep 3 times. The control will continue to beep 3 times every 30 seconds until **CANCEL** is pressed.

CAUTION

Use caution with the **DELAY START** features. Use the automatic timer when cooking cured or frozen meats and most fruits and vegetables. Foods that can easily spoil such as milk, eggs, fish, meat or poultry, should be chilled in the refrigerator first. Even when chilled, they should not stand in the oven for more than 1 hour before cooking begins, and should be removed promptly when cooking is completed. Eating spoiled food can result in sickness from food poisoning.

SETTING DELAY START

The **BAKE**, **CONVECTION BAKE**, **BAKE TIME** and **DELAY START** pads control the Delayed Time Bake feature. The automatic timer of the Delayed Time Bake will turn the oven **on and off** at the time you select in advance.

NOTE

If your clock is set for normal 12 hour display mode the Delayed Timed Bake or Delayed Timed Convection Bake cycle can never be set to start more than 12 hours in advance. To set for Delayed Timed Bake or Delayed Timed Convection Bake 12-24 hours in advance set the control for the 24 hour time of day display mode.

To program the oven for a delayed BAKE start time (example: baking at 375°F, starting at 5:30):

1. Be sure that the clock is set with the correct time of day.
2. Arrange interior oven rack and place the food in the oven.
3. Press **BAKE**. "350" will appear in the display.
4. Enter the desired temperature; pressing **3 7 5**.
5. Press **START**. The actual oven temperature will appear in the display.
6. Press **DELAY START**.
7. Enter the desired start time; pressing **5 3 0**.
8. Press **START**. When Delayed Time Bake starts, the set oven temperature will appear, "DELAY", "BAKE" and the current time of day will appear in the display.

NOTE

If it is desired to have the oven shut off automatically after a set time; enter a **BAKE TIME** at this step.

7. When the desired start time is reached, the actual oven temperature appears in display and "DELAY" disappears. Oven starts to bake at the previously selected temperature.

Press **CANCEL** when baking has completed or at any time to cancel the Delayed Time Bake feature.

SETTING OVEN CONTROLS

SETTING BROIL

This mode is best for meats, fish and poultry up to 1" thick. Broiling is a method of cooking tender cuts of meat by direct heat under the broil element of the oven. The high heat cooks quickly and gives a rich, brown outer appearance. The **BROIL** pad controls the Broil feature. An optional Searing Grill, Broiler Pan and Insert are available via the enclosed accessories brochure (Figure 2 & 3). The optional broil pan and broil pan insert used together allow dripping grease to drain and be kept away from the high heat of the oven broiler. The oven can be programmed to broil at any temperature from 400°F to 550°F with a default temperature of 550°F.

Broiling Tips:

- For optimum browning, preheat the broil element for 5 minutes.
- Broil one side until the food is browned; turn and cook on the second side. Season and serve.
- Always pull the rack out to the "stop" position before turning or removing food.
- Always use the broiler pan and its cover when broiling. It allows the dripping grease to be kept away from the high heat of the broil element (see Figure 2).
- For best broiling results, broil with the oven door in the broil stop position (see Figure 1).
- If using a Searing Grill (available by mail order), preheat the grill for 5 to 10 minutes before placing your meat.
- **DO NOT** use the broil pan without the insert. **DO NOT cover the broil pan insert with foil.** The exposed grease could catch fire.

Accessories available via the enclosed brochure:

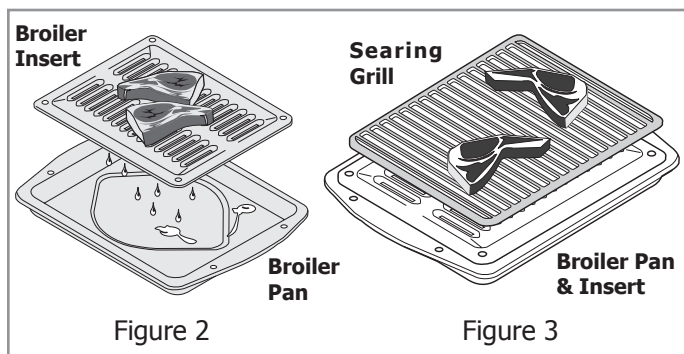

To set a Broil of 500°F:

1. Place the broiler pan insert on the broiler pan. Then place the food on the broiler pan insert. **DO NOT** use the broiler pan without the insert. **DO NOT** cover the broiler insert with foil. The exposed grease could ignite.
2. Arrange the interior oven rack and place the broiler pan on the rack. Be sure to center the broiler pan directly under the broiler element. **Make sure the oven door is in the broil stop position (See Figure 1).**
3. Preheat for 2 minutes before broiling.
4. Press **BROIL**. "550" will appear in the display.
5. Press **5 0 0**. If a lower broil temperature is desired (minimum broil temperature setting is 400°F), press the desired temperature before continuing to step 5.
6. Press **START**. The oven will begin to broil. "500°" will appear in the display.
7. Broil on one side until food is browned; turn and cook on the second side. Season and serve. **Note:** Always pull the rack out to the stop position before turning or removing food.
8. To stop broiling press **CANCEL**.

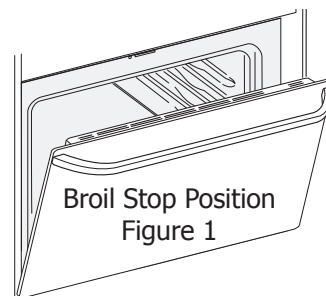

NOTE

To assure your electronic controls safety when broiling with the oven door in broil position, an high speed cooling fan will blow air through the trims above the door(s).

WARNING

Should an oven fire occur, leave the oven door closed and turn off the oven. If the fire continues, throw baking soda on the fire or use a fire extinguisher. **DO NOT** put water or flour on the fire. Flour may be explosive and water can cause a grease fire to spread and cause personal injury.

Electric Oven Broiling Table Recommendations

Food Item	Rack Position	Temperature Setting	Cook Time		Doneness
			1st side	2nd side	
Steak 1" thick	3rd or 4th	550° F	6:00	4:00	Rare
	3rd or 4th	550° F	7:00	5:00	Medium
Pork Chops 3/4" thick	3rd or 4th	550° F	8:00	6:00	Well
Chicken - Bone In	3rd	450° F	20:00	10:00	Well
Chicken - Boneless	3rd or 4th	450° F	8:00	6:00	Well
Fish	3rd	500° F	13:00	-	Well
Shrimp	3rd	550° F	5:00	-	Well
Hamburger 1" thick	3rd or 4th	550° F	9:00	7:00	Medium
	3rd or 4th	550° F	10:00	8:00	Well

SETTING CHICKEN NUGGETS

The **CHICKEN NUGGETS** pad has been designed to give optimum cooking performance when cooking your favorite chicken nuggets. The Chicken Nuggets pad is preset for a Convection Bake at (400°F) with a Bake Time of 18 minutes, ending with a Keep Warm setting. If needed, a different target temperature or Bake Time than the presets can be entered.

Chicken Nuggets Tips:

- For most type of chicken nuggets, preheating is not required and the preset baking time of the feature will give you optimum results.
- For larger chicken tenders, follow the preheating and baking instructions on the box and only use a single rack.
- For a single rack, use rack position 2.
- For multiple racks, use rack positions 2 and 3.

To set Chicken Nuggets:

1. Arrange interior oven racks and place food in oven.
2. Press **CHICKEN NUGGETS** pad. "CHI" will appear in the display. If a different temperature than 400°F is needed, enter the temperature now, using the keypad digits. If a different Bake Time than 18 minutes is required, press **BAKE TIME** and enter the desired time (or 0 for an untimed baking) and **START** to accept the time.
3. Press **START**. The fan icon will appear in the display.
4. To turn OFF the Chicken Nuggets feature at any time press **CANCEL**.

NOTE

The Chicken Nuggets feature is automatically programmed to activate the Keep Warm feature when the cooking is finished. "HLD" will be displayed for a maximum of 3 hours. See the Keep Warm feature for more information.

SETTING PIZZA

The **PIZZA** pad has been designed to give optimum cooking performance when cooking your favorite pizza. The Pizza pad let you choose a preset between a frozen pizza (425°F) and a fresh pizza (400°F). If needed, a different target temperature than the presets can be entered. Some fresh pizza request using a broil feature for a few minutes, but this is not part of the Pizza pad presets.

Pizza Tips:

- Follow the instructions on the box for preheating and baking times.
- For optimum cooking results, only bake one pizza at once on rack position 2.
- Check the pizza at 75% of the maximum cook time listed on the package.

To set Pizza for a frozen pizza:

1. Arrange interior oven racks.
2. Press **PIZZA** pad. "Fro" will appear in the display. If a different temperature than 425°F is needed, enter the temperature now, using the keypad digits.
3. Press **START**. The fan icon and the actual oven temperature will appear in the display.
4. Place the pizza in the oven when the beep is heard.
5. If needed, enter a **BAKE TIME** (see its section for further details).
6. To turn OFF the Pizza feature at any time press **CANCEL**.

To set Pizza for a fresh pizza:

1. Arrange interior oven racks.
2. Press **PIZZA** pad **twice**. "Frh" will appear in the display. If a different temperature than 400°F is needed, enter the temperature now, using the keypad digits.
3. Press **START**. The fan icon and the actual oven temperature will appear in the display.
4. Place the pizza in the oven when the beep is heard.
5. If needed, enter a **BAKE TIME** (see its section for further details).
6. To turn OFF the Pizza feature at any time press **CANCEL**.

SETTING OVEN CONTROLS

SETTING KEEP WARM

This mode is best for keeping oven baked foods warm for serving after cooking has finished. The **KEEP WARM** pad turns ON the Keep Warm feature and will maintain an oven temperature of 170°F. The Keep Warm feature will keep oven baked foods warm for serving up to 3 hours after cooking has finished. **After 3 hours the Keep Warm feature will shut the oven OFF.** The Keep Warm feature may be used without any other cooking operations or can be set to turn ON automatically after a **BAKE TIME** or **DELAYED BAKE TIME**.

Keep Warm Tips:

- Always start with hot food.
- Do not use the Keep Warm feature to heat cold food.
- Food in heat-safe glass and glass ceramic containers may need higher temperature settings compared to food in regular containers.
- Avoid repeated openings of the oven, it will allow hot air to escape and the food to cool.
- Aluminum foil may be used to cover food to increase moisture content.

To set Keep Warm:

1. Arrange interior oven racks and place food in oven.
2. Press **KEEP WARM**. "Hld" will appear in the display. Note: If no pad is touched within 25 seconds the request to turn ON Keep Warm feature will be cancelled.
3. Press **START**. The oven icon will appear in the display.
4. To turn OFF the KEEP WARM at any time press **CANCEL**.

To set Keep Warm to turn ON automatically:

1. Arrange interior oven racks and place food in oven. Set the oven properly for **Bake Time or Delayed Bake Time**. (See their respective sections for more details).
2. Press **KEEP WARM**. "Hld" will appear in the display. Note: If no pad is touched within 25 seconds, the request to turn ON Keep Warm feature will be cleared.
3. Press **START**. "Hld" will disappear and the temperature will be displayed. The Keep Warm mode is set to turn ON automatically after Timed Bake has finished.
4. To turn the Keep Warm feature OFF at any time press **CANCEL**.

NOTE

Pressing **CANCEL** will stop the feature at any time.

SETTING MY FAVORITE

The My Favorite setting allow you to save your most frequently used or most complex cooking sequence. This feature will save the cooking mode, the target temperature and the bake time (if any). The oven can recall a cooking sequences from its internal memory, which is easily accessible from a one touch button. This function can be used with Bake, Convection Bake, Convection Roast and Preheat.

To save a Favorite (example is a 450°F Bake for 30 minutes):

1. Press **BAKE**. The default temperature will appear in the display.
2. Enter temperature needed; **4 5 0**.
3. Press **START**.
4. Press **BAKE TIME**.
5. Enter time needed; **3 0**.
6. Press **START**.
7. Press and hold for 3 seconds **MY FAVORITE** pad. The ♥ icon will be shown to confirm your setting has been saved.

To recall a Favorite:

1. Press **MY FAVORITE** pad.
2. Press **START**.

NOTE

Recalling a Favorite can only be done when the oven is not currently in operation.

To overwrite a Favorite:

1. To overwrite My Favorite simply start a new cooking sequence and save it as shown in example above. The new My Favorite settings will overwrite the old ones.

To delete a Favorite:

1. Press the **MY FAVORITE** pad to delete for **3 seconds** while the oven is not in operation and no cooking mode has been set. The ♥ icon will disappear.

SETTING OVEN CONTROLS

SETTING THE SABBATH FEATURE (for use on the Jewish Sabbath & Holidays)

The **BAKE TIME** and **DELAY START** pads are used to set the Sabbath feature. The Sabbath feature may only be used with the **BAKE** pad. The oven temperature may be set higher or lower after setting the Sabbath feature (the oven temperature adjustment feature should be used only during Jewish Holidays), however the display will not visibly show or provide any audible tones indicating whether the change occurred correctly. Once the oven is properly set using Bake with the Sabbath feature active, the oven will remain continuously ON until cancelled. This will override the factory preset 6-Hour Energy Saving feature.

If the oven light will be needed during the Sabbath, press **OVEN LIGHT**  before activating the Sabbath feature. Once the oven light is turned ON and the Sabbath feature is active, the oven light will remain ON until the Sabbath feature is turned OFF. If the oven light needs to be OFF, be sure to turn the oven light OFF before activating the Sabbath feature.

To Program the Oven to Begin Baking Immediately & activate the Sabbath feature (example: baking at 350°F)

1. Be sure that the clock is set with the correct time of day.
2. Place the food in the oven.
3. Press **BAKE**. "350°" appears in the display.
4. Press **START**. The actual oven temperature appears in the display.
5. If you desire to set the oven control for a **Bake Time** or **Delayed Bake Time** do so at this time. If not, skip this step and continue to step 7. Refer to the **Bake Time / Delay Start** section for complete instructions. Remember the oven will shut down after using **Bake Time** or **Delay Start** and therefore may only be used once during the Sabbath/Jewish Holidays. The maximum **Delayed Start Bake** time is 11 hours & 59 minutes.
6. The oven will turn ON and begin heating.
7. Press and hold both the **BAKE TIME** and **DELAY START** pads for at least **3 seconds**. "SAb" will appear in the display. Once "SAb" appears in the display the oven control will no longer beep or display any further changes and the oven is properly set for the Sabbath feature.
8. The oven may be turned OFF at any time by first pressing **CANCEL** pad (this will turn the oven OFF only). To turn OFF the Sabbath feature press and hold both the **BAKE TIME** and **DELAY START** pads for at least **3 seconds**. "SAb" will disappear from the display.

IMPORTANT

It is not advised to attempt to activate any other program feature other than **BAKE** while the Sabbath feature is active. ONLY the following key pads will function after setting the Sabbath feature; **0 to 9, BAKE, START & CANCEL**. All other keypads should not be used once the Sabbath feature is properly activated.

NOTE

You may change the oven temperature once baking has started by pressing **BAKE**, the numeric key pads for the temperature you want (example for 425°F press **4 2 5**) and then pressing **START twice** (for Jewish Holidays only). Remember that **the oven control will no longer beep or display any further changes** once the oven is set for the Sabbath feature.

Should you experience a power failure or interruption, the oven will shut off. When power is returned, "SF" (Sabbath Failure) will be displayed and the oven will not turn back on automatically. If your food was nearly fully cooked, you may allow the trapped heat in the oven to finish the cooking process. Otherwise, you should remove the food when the power failure occurs, because you may only start the oven once during the Sabbath/Jewish Holidays. After the Sabbath observance turn OFF the Sabbath feature and the oven may be used with all normal functions.

After the Sabbath observance turn OFF the Sabbath feature. Press and hold both the **BAKE TIME** and **DELAY** pads for at least **3 seconds**. "SAb" will disappear from the display and the oven may be used with all normal functions. For further assistance, guidelines for proper usage, and a complete list of models with the Sabbath feature, please visit the web at <http://www.star-k.org>.

SETTING OVEN CONTROLS

ADJUSTING OVEN TEMPERATURE

The temperature in the oven has been pre-set at the factory. When first using the oven, be sure to follow recipe times and temperatures. If you think the oven is cooking too hot or too cool for the temperature you select, you can adjust the actual oven temperature to be more or less than what is displayed. Before adjusting, test a recipe by using a temperature setting that is higher or lower than the recommended temperature. The baking results should help you to decide how much of an adjustment is needed.

NOTE

The oven temperature adjustments made with this feature will not change the Self-Clean cycle temperature or the Broil temperature.

To adjust the oven temperature higher

1. Press **BAKE** for 6 seconds. "UPO 0" will appear in the display.
2. To increase the temperature use the number pads to enter the desired change (Example 30°F) **3 0**. The temperature may be increased as much as 35°F (19°C).
3. Press **START** to accept the temperature change and the display will return to the time of day. Press **CANCEL** to reject the change if necessary.

To adjust the oven temperature lower

1. Press **BAKE** for 6 seconds. 0° will appear in the display.
2. To decrease the temperature use the number pads to enter the desired change (Example -30°F) **3 0** and then press **SELF CLEAN**. The temperature may be decreased as much as 35°F (19°C).
3. Press **START** to accept the temperature change and the display will return to the time of day. Press **CANCEL** to reject the change if necessary.

NOTE

The oven temperature adjustments are permanent and will stay forever in the unit memory unless you manually change it again. Even a power outage will not reset these changes. Follow the same procedure again if you wish to change it to a different setting.

OVEN LIGHT

The oven is equipped with 2 oven lights. The oven lights will turn on automatically, when the oven door is opened.

The oven light may be turned on when the door is closed by using the oven light pad located on the control panel. The oven light key will toggle the lights at full intensity.

To toggle the Oven Lights ON and OFF:

1. Press **OVEN LIGHT** .

The interior oven lights are covered with a glass shield held by a wire holder. The glass shield must be in place whenever the oven is in use.

To change the interior oven lights, see "Changing the oven light" in the **Care & Cleaning** section.

SELF-CLEANING

A self-cleaning oven cleans itself with high temperatures (well above normal cooking temperatures) which eliminate soils completely or reduces them to a fine powdered ash you can wipe away with a damp cloth.

▶ IMPORTANT

Adhere to the following cleaning precautions:

- **DO NOT** use oven cleaners or oven protective coatings in or around any part of the oven interior.
- **DO NOT** clean the oven door gasket. The woven material of the oven door gasket is essential for a good seal. Care should be taken not to rub, damage or remove the gasket.
- **DO NOT** use any cleaning materials on the oven door gasket. Doing so could cause damage.
- **Remove the broiler pan and insert, all utensils and ANY ALUMINUM FOIL. These items cannot withstand high cleaning temperatures and will melt.**
- **Completely remove ALL OVEN RACKS and ANY ACCESSORIES. If the oven racks are not removed, they will lose their special coating properties and will no longer slide in and out of the oven cavity effortlessly.**
- **Remove any excessive spillovers** in the oven cavity **before** starting the Self-Cleaning cycle. To clean, use hot, soapy water and a cloth. Large spillovers can cause heavy smoke or fire when subjected to high temperatures. **DO NOT** allow food spills with a high sugar or acid content (such as milk, tomatoes, sauerkraut, fruit juices or pie filling) to remain on the surface as they may leave a dull spot even after cleaning.
- Clean any soil from the oven frame, the door liner outside the oven door gasket and the small area at the front center of the oven bottom. These areas heat sufficiently to burn soil on. Clean with soap and water.



What to Expect during Cleaning

While the oven is in operation, the oven heats to temperatures much higher than those used in normal cooking. Sounds of metal expansion and contraction are normal. Odor is also normal as the food soil is being removed. Smoke may appear through the oven vent.

If heavy spillovers are not wiped up before cleaning, they may flame and cause more smoke and odor than usual. This is normal and safe and should not cause alarm. If available, use an exhaust fan during the self-cleaning cycle.

! CAUTION

To avoid possible burns use care when opening the oven door after the Self-Cleaning cycle. Stand to the side of the oven when opening the door to allow hot air or steam to escape.

During the Self-Cleaning cycle, the outside of the range can become very hot to the touch. **DO NOT** leave small children unattended near the appliance.

The health of some birds is extremely sensitive to the fumes given off during the Self-Cleaning cycle of any range. Move birds to another well-ventilated room.

DO NOT line the oven walls, racks, bottom or any other part of the range with **aluminum foil**. Doing so will destroy heat distribution, produce poor baking results and cause permanent damage to the oven interior (aluminum foil will melt to the interior surface of the oven).

DO NOT force the oven door open. This can damage the automatic door locking system. Use caution when opening the door after the Self-Cleaning cycle is completed. The oven may still be **VERY HOT**.

📌 NOTE

See additional cleaning information for the oven door in the **General Care & Cleaning** section.

SELF-CLEANING

SETTING SELF-CLEAN CYCLE TIME LENGTH

The **SELF CLEAN** pad controls the Self-Cleaning feature. If you are planning to use the oven directly after a self-clean cycle remember to allow time for the oven to cool down and the oven door to unlock. This normally takes about one hour. So a 3 hour self-clean cycle will actually take about 4 hours to complete.



*It is recommend to use a 2 hour self-clean cycle for **light soils**, a 3 hour cycle for **average soils**, and a 4 hour cycle for **heavy soils** (to assure satisfactory results).

To set the controls for a 3 hour Self-Cleaning cycle to start immediately and shut off automatically

1. Be sure the clock is set with the correct time of day and the oven door is closed.
2. Press **SELF CLEAN**. "CLn" and "3:00" HR will show in the display. The control will automatically clean for a 3 hour period (default self-cleaning cycle time).

NOTE



If a 2 or 4 hour clean time is desired, press **SELF CLEAN** multiple times to toggle between 2, 3 or 4 hours.

3. Press **START**. "door Loc" will appear, a beep will sound and the "DOOR" and  icon will flash; the letters "CLn" will remain on in the display.
4. As soon as the control is set, the motor driven oven door lock will begin to close automatically. Once the door has been locked the "DOOR" indicator light and  icon will stop flashing and remain on. Also, the oven icon will appear in the display.

NOTE

Allow about 15 seconds for the oven door lock to close.

When the Self-Clean Cycle is Completed

1. "HOT" will appear in the display. The time of day, the "DOOR" and  icon will remain in the display.
2. Once the oven has cooled down for approximately 1 HOUR, "door OPn" will appear and the "DOOR" and  icon will flash until the door is unlocked, the oven door can then be opened and the timer will revert back to the time of the day.

Stopping or Interrupting a Self-Cleaning Cycle

If it becomes necessary to stop or interrupt a self-cleaning cycle due to excessive smoke or fire in the oven:

1. Press **CANCEL**.
2. The oven door can only be opened after the oven has cooled down for approximately 1 HOUR, "door OPn" will appear and the "DOOR" and  icon will flash until the door is unlocked, the oven door can then be opened and the timer will revert back to the time of the day.

SETTING A DELAYED START SELF-CLEAN CYCLE



The **SELF CLEAN** and **DELAY START** pads controls the Delayed Self-Clean operation. The automatic timer will turn the oven **on and off** at the time you select in advance.

To set the control for the Self-Cleaning Cycle to start at a delayed time and shut off automatically (example: 3 hour self-clean cycle to start at 4:30)



1. Be sure the clock is set with the correct time of day and the oven door is closed.
2. Press **SELF CLEAN**. "CLn" and "3:00" HR will show in the display. The control will automatically clean for a 3 hour period.

NOTE

If a 2 or 4 hour clean time is desired, press **SELF CLEAN** multiple times to toggle between 2, 3 or 4 hours.

3. Press **START**. "door Loc" will appear, a beep will sound and the "DOOR" and  icon will flash; the letters "CLn" will remain on in the display.
4. As soon as the control is set, the motor driven oven door lock will begin to close automatically. Once the door has been locked the "DOOR" and  icon indicator light will quit flashing and remain on.
5. Press **DELAY START**. Enter the desired start time using the number pads **4 3 0**.
6. Press **START**. "DELAY", "DOOR" and  icon icons will remain on.
7. The control will start the self-cleaning at the set start time, for the period of time previously selected. At that time, the icon "DELAY" will go out; "CLn" and oven icon will appear in the display.

When the Self-Clean Cycle is Completed

1. "HOT" will appear in the display. The time of day, the "DOOR" and  icon will remain in the display.
2. Once the oven has cooled down for approximately 1 HOUR, "door OPn" will appear and the "DOOR" and  icon will flash until the door is unlocked, the oven door can then be opened and the timer will revert back to the time of the day.

Stopping or Interrupting a Self-Cleaning Cycle

If it becomes necessary to stop or interrupt a self-cleaning cycle due to excessive smoke or fire in the oven:

1. Press **CANCEL**.
2. The oven door can only be opened after the oven has cooled down for approximately 1 HOUR, "door OPn" will appear and the "DOOR" and  icon will flash until the door is unlocked, the oven door can then be opened and the timer will revert back to the time of the day.

CARE & CLEANING (MICROWAVE CLEANING CHART)

Disconnect the power cord before cleaning or leave the door open to deactivate the oven during cleaning.

EXTERIOR

The outside surface is precoated steel and plastic. Clean the outside with mild soap and water; rinse and dry with a soft cloth. Do not use any type of household or abrasive cleaner.

DOOR

Wipe the window on both sides with a damp cloth to remove any spills or splatters. Metal parts will be easier to maintain if wiped frequently with a damp cloth. Cleaners which are marked specifically for use with stainless steel may be used. Follow package directions exactly. Avoid the use of any harsh cleaner or one not marked for stainless steel use as they may stain, streak or dull the door surface.

EASY CARE™ STAINLESS STEEL (some models)

Your microwave oven finish may be made with Easy Care™ Stainless Steel (some models). Clean the stainless with warm soapy water using a clean sponge or cloth. Rinse with clean water and dry with a soft clean cloth. DO NOT use ANY store bought cleaners like Stainless Steel cleaners or any other types of cleaners containing any abrasive, chlorides, chlorines or ammonia. It is recommended to use mild dish soap and water or a 50/50 solution of water and vinegar.

TOUCH CONTROL PANEL

Care should be taken in cleaning the touch control panel. If the control panel becomes soiled, open the microwave oven door before cleaning. Wipe the panel with a cloth dampened slightly with water only. Dry with a soft cloth. Do not scrub or use any sort of chemical cleaners. Close door and press STOP/clear.

INTERIOR

Cleaning is easy because little heat is generated to the interior surfaces; therefore, there is no baking and setting of spills or spattering. To clean the interior surfaces, wipe with a soft cloth and warm water. DO NOT USE ABRASIVE OR HARSH CLEANERS OR SCOURING PADS. For heavier soil, use baking soda or a mild soap; rinse thoroughly with hot water.

WAVEGUIDE COVER

The waveguide cover is made from mica so requires special care. Keep the waveguide cover clean to assure good microwave oven performance. Carefully wipe with a damp cloth any food splatters from the surface of the cover immediately after they occur. Built-up splashes may overheat and cause smoke or possibly catch fire. DO NOT REMOVE THE WAVEGUIDE COVER.

ODOR REMOVAL

Occasionally, a cooking odor may remain in the microwave oven. To remove, combine 1 cup water, grated peel and juice of 1 lemon and several whole cloves in a 2-cup glass measuring cup. Boil for several minutes using 100% power. Allow to set in microwave oven until cool. Wipe interior with a soft cloth.

TURNTABLE/TURNTABLE SUPPORT

The turntable and turntable support can be removed for easy cleaning. Wash them in mild, sudsy water; for stubborn stains use a mild cleanser and non abrasive scouring sponge. They are also dishwasher-proof. Use upper rack of dishwasher. The turntable motor shaft is not sealed, so excess water or spills should be wiped up immediately.

CARE & CLEANING (OVEN CLEANING CHART)

CLEANING VARIOUS PARTS OF YOUR RANGE

Before cleaning any part of the range, be sure all controls are turned OFF and the range is COOL. REMOVE SPILLOVERS AND HEAVY SOILING AS SOON AS POSSIBLE. REGULAR CLEANING WILL REDUCE THE NUMBER OF MAJOR CLEANING LATER.

SURFACE TYPE	RECOMMENDATION
<ul style="list-style-type: none">• Aluminum & Vinyl	Use hot, soapy water and a cloth. Dry with a clean cloth.
<ul style="list-style-type: none">• Painted and plastic control knobs• Painted body parts• Painted decorative trims	Using a soft cloth, clean with mild dish detergent and water or a 50/50 solution of vinegar and water. Follow by rinsing the area with clean water; dry and polish with a soft cloth. Glass cleaners may be used if sprayed on a soft cloth first. DO NOT spray liquids directly on the control pad and display area. Do not use large amounts of water on the control panel - excess water on the control area may cause damage to the appliance. Do not use other liquid cleaners, abrasive cleaners, scouring pads, or paper towels - they will damage the finish. To remove control knobs, turn to the OFF position; grasp firmly and pull straight off the shaft. To replace knobs after cleaning, line up the flat sides of both the knob and the shaft; then push the knob into place.
<ul style="list-style-type: none">• EasyCare™ Stainless Steel	Your range finish is may be made with Easy Care™ Stainless Steel (some models). Clean the stainless with warm soapy water using a clean sponge or cloth. Rinse with clean water and dry with a soft clean cloth. DO NOT use ANY store bought cleaners like Stainless Steel cleaners or any other types of cleaners containing any abrasive, chlorides, chlorines or ammonia. It is recommended to use mild dish soap and water or a 50/50 solution of water and vinegar.
<ul style="list-style-type: none">• Porcelain enamel broiler pan and insert (available by mail order)• Door liner & body parts	Gentle scouring with a soapy scouring pad will remove most spots. Rinse with a 1:1 solution of clear water and ammonia. If necessary, cover difficult spots with an ammonia-soaked paper towel for 30 to 40 minutes. Rinse with clean water and a damp cloth, and then scrub with a soap-filled scouring pad. Rinse and wipe dry with a clean cloth. Remove all cleaners or the porcelain may become damaged during future heating. DO NOT use spray oven cleaners on the cooktop.
<ul style="list-style-type: none">• Oven racks	Oven racks must be removed from oven cavity. Clean by using a mild, abrasive cleaner following manufacturer's instructions. Rinse with clean water and dry.
<ul style="list-style-type: none">• Oven door	Use soap & water to thoroughly clean the top, sides and front of the oven door. Rinse well. You may use a glass cleaner on the outside glass of the door. Do not immerse the door in water. Do not spray or allow water or the glass cleaner to enter the door vents. Do not use oven cleaners, cleaning powders or any harsh abrasive cleaning materials on the outside of the oven door. Do not clean the oven door gasket. On self-clean models, the oven door gasket is made of a woven material which is essential for a good seal. Care should be taken not to rub, damage or remove this gasket.

REMOVING AND REPLACING THE LIFT-OFF OVEN DOOR

CAUTION

The door is heavy. For safe, temporary storage, lay the door flat with the inside of the door facing down.

To Remove Oven Door:

1. Open oven door completely (horizontal with floor - See Figure 1).
2. Pull the door hinge locks on both left and right door hinges down from the oven frame completely towards the oven door (See Figure 2). A tool such as a small flat-blade screwdriver may be required.
3. Firmly grasp both sides of oven door along the door sides (Do not use the oven door handle - See Figure 3).
4. Close the door to the broil stop position (the oven door will stop into this position just before fully closing).
5. With the oven door in the broil stop position, lift the oven door hinge arms over the roller pins located on each side of the oven frame (See Figure 4).

To Replace Oven Door:

1. Firmly grasp both sides of oven door along the door sides (Do not use the oven door handle - See Figure 3).
2. Holding the oven door at the same angle as the removal position, seat the hook of the hinge arm over the roller pins located on each side of the oven door frame (See Figure 4). The hook of the hinge arms must be fully seated onto the roller pins.
3. Fully open the oven door (horizontal with floor - See Figure 1).
4. Push the door hinge locks up towards and into the oven frame on both left and right oven door hinges (See Figure 2) to the locked position.
5. Close the oven door.

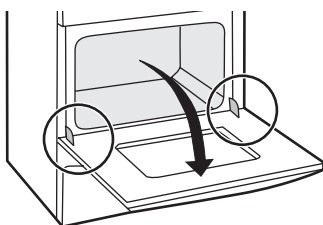

Door Hinge locations with oven door fully open

Figure 1

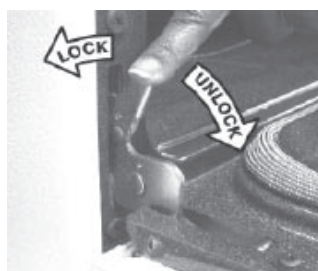

Figure 2

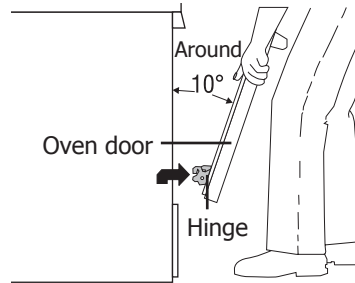

Figure 3

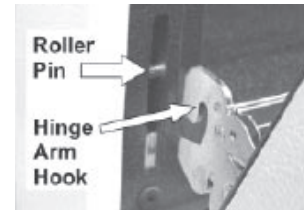

Figure 4

Special Door Care Instructions - Most oven doors contain glass that can break.

Read the following recommendations:

1. Do not close the oven door until all the oven racks are fully in place.
2. Do not hit the glass with pots, pans, or any other object.
3. Scratching, hitting, jarring or stressing the glass may weaken its structure causing an increased risk of breakage at a later time.

CHANGING OVEN LIGHT

CAUTION

Be sure the oven is unplugged and all parts are COOL before replacing the oven light bulb. Do not turn the oven light on during a self-cleaning cycle. High temperature will reduce lamp life.

On some models an interior oven light will turn on automatically when the oven is opened. The oven light may be turned on when the door is closed by using the oven light switch located on the Electronic Oven control. The oven light bulb is covered with a glass shield held in place by a wire holder. THIS GLASS SHIELD MUST ALWAYS BE IN PLACE WHEN THE OVEN IS IN USE.

To Replace the Light Bulb:

CAUTION

BE SURE OVEN IS COOL

1. Turn the power off at the main source.
2. Wear a leather-faced glove for protection against possible broken glass.
3. Replace bulb with a 40 Watt appliance bulb only.
4. For self-cleaning oven, press wire holder to one side to release glass shield, change bulb and be sure to replace glass shield.

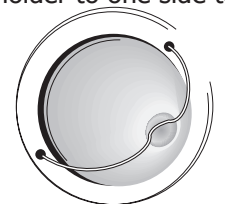





BEFORE YOU CALL - Solutions to Common Problems

OVEN BAKING

For best cooking results, heat the oven before baking cookies, breads, cakes, pies or pastries, etc. There is no need to preheat the oven for roasting meat or baking casseroles.

The cooking times and temperatures needed to bake a product may vary slightly from your previously owned appliance.

Baking Problems and Solutions Chart

BAKING PROBLEMS	CAUSES	CORRECTIONS
<p>Cookies and biscuits burn on the bottom.</p> 	<ul style="list-style-type: none"> • Cookies and biscuits put into the oven before the preheating time is completed. • Oven rack overcrowded. • Dark pan absorbs heat too fast. 	<ul style="list-style-type: none"> • Allow oven to preheat to the selected temperature before placing food in oven. • Choose pan sizes that will permit 2" to 4" of air space on all sides when placed in the oven. • Use a medium-weight aluminum baking sheet.
<p>Cakes too dark on top or bottom.</p> 	<ul style="list-style-type: none"> • Cakes put into the oven before preheating time is completed. • Rack position too high or low. • Oven too hot. 	<ul style="list-style-type: none"> • Allow oven to preheat to the selected temperature before placing food in the oven. • Use proper rack position for baking needs. • Set oven temperature 25°F/12°C lower than recommended.
<p>Cakes not done in the center.</p> 	<ul style="list-style-type: none"> • Oven too hot. • Incorrect pan size. • Pan not centered in oven. 	<ul style="list-style-type: none"> • Set oven temperature 25°F/12°C lower than recommended. • Use pan size suggested in recipe. • Use proper rack position and place pan so there is 2" to 4" of space on all sides of pan.
<p>Cakes not level.</p> 	<ul style="list-style-type: none"> • Range not level. • Pan too close to oven wall or rack overcrowded. • Pan warped. 	<ul style="list-style-type: none"> • Place a marked glass measuring cup filled with water on the center of the oven rack. If the water level is uneven, refer to the installation instructions for leveling the range. • Be sure to allow 2" to 4" of clearance on all sides of each pan in the oven. • Do not use pans that are dented or warped.
<p>Foods not done when cooking time is up.</p> 	<ul style="list-style-type: none"> • Oven too cool. • Oven overcrowded. • Oven door opened too frequently. 	<ul style="list-style-type: none"> • Set oven temperature 25°F/12°C higher than suggested and bake for the recommended time. • Be sure to remove all pans from the oven except the ones to be used for baking. • Open oven door only after shortest recommended baking time.

Solutions to Common Problems - **BEFORE YOU CALL**

IMPORTANT

Before you call for service, review this list. It may save you time and expense. The list includes common occurrences that are not the result of defective workmanship or materials in this appliance.

OCCURRENCE	POSSIBLE CAUSE/SOLUTION
Oven Control Beeps and Displays an "F" Error Code	Electronic control has detected a fault condition. Push CANCEL pad to clear the display and stop the display from beeping. Reprogram the oven. If a fault reoccurs, record the fault number, push the CANCEL pad and contact an authorized servicer.
Faulty Installation	Place oven rack in center of oven. Place a level on the oven rack. Contact installing agent if rack and cabinet cutout flooring are not level. Kitchen cabinet misalignment may make oven appear to be not level. Be sure cabinets are square and level. Contact cabinet maker to correct problem.
Entire Oven Does Not Operate	When the oven is first plugged in, or when the power supply to the oven has been interrupted, the display will flash. The oven cannot be programmed until the clock is set. Be sure electrical cord is securely connected into the electrical junction box. Cord/plug is not installed and/or connected. Cord is not supplied with oven. Contact your dealer, installing agent or authorized servicer. Service wiring not complete. Contact your dealer, installing agent or authorized servicer. Power outage. Check house lights to be sure. Call your local electric company. Short in cord/plug. Replace cord/plug. Controls are not set properly. See instructions to set the controls. House fuse has blown or circuit breaker has tripped immediately following installation. House fuse may not be fully engaged. Check fuse and screw or engage circuit breaker securely.
Oven Light Does Not Work	Burned-out or loose bulb. Follow the instructions under Oven Light to replace or tighten the bulb.
Self-Cleaning Cycle Does Not Work	Make sure the oven door is closed. Make sure you have removed the oven racks and the oven rack supports from the oven. Controls not set properly. Follow instructions under "Using the Self-Clean Feature".
Oven Smokes Excessively During Broiling	Meat too close to the broiler element. Reposition the rack to provide more clearance between the meat and the broiler. Preheat broil element for quick searing operation. Meat not properly prepared. Remove excess fat from meat. Cut remaining fatty edges to prevent curling, but do not cut into the lean. Grid on broiler pan wrong side-up. Grease does not drain into broiler pan. Always place the grid on the broiler pan with the ribs up and the slots down to allow grease to drip into the pan. Broiler pan used without grid or grid cover with aluminum foil. DO NOT use the broiler pan without the grid or cover the grid with aluminum foil. Oven needs to be cleaned. Grease has built up on oven surfaces. Regular cleaning is necessary when broiling frequently. Grease or food spatters cause excessive smoking.
Soil Not Completely Removed After Self-Cleaning Cycle is Completed	Failure to clean bottom, from top of oven, frame of oven or door area outside oven seal. These areas are not in the self-cleaning area, but get hot enough to burn on residue. Clean these areas before the self-cleaning cycle is started. Burned on residue can be cleaned with a stiff nylon brush and water or a nylon scrubber. Be careful not to damage the oven gasket. Excessive spillovers in oven. Set the self-clean cycle for longer cleaning time.
Poor Baking Results	Many factors affect baking results. See Baking for hints, causes and corrections. See Adjusting Oven Temperature.
Flames Inside Oven or Smoke from Vent	Excessive spillovers in oven. This is normal, especially for high oven temperatures, pie spillovers or for large amounts of grease on bottom of oven. Wipe up excessive spillovers.
Cooling Fan Noisy	At high temperature in the oven, the hi speed cooling fan will start and will cause it to be noisier than normal, but this is normal function to protect the electronic control.

MAJOR APPLIANCE WARRANTY

Your appliance is covered by a one year limited warranty. For one year from your original date of purchase, Electrolux will pay all costs for repairing or replacing any parts of this appliance that prove to be defective in materials or workmanship when such appliance is installed, used and maintained in accordance with the provided instructions.

Exclusions This warranty does not cover the following:

- 1 Products with original serial numbers that have been removed, altered or cannot be readily determined.
- 2 Product that has been transferred from its original owner to another party or removed outside the USA or Canada.
- 3 Rust on the interior or exterior of the unit.
- 4 Products purchased "as-is" are not covered by this warranty.
- 5 Food loss due to any refrigerator or freezer failures.
- 6 Products used in a commercial setting.
- 7 Service calls which do not involve malfunction or defects in materials or workmanship, or for appliances not in ordinary household use or used other than in accordance with the provided instructions.
- 8 Service calls to correct the installation of your appliance or to instruct you how to use your appliance.
- 9 Expenses for making the appliance accessible for servicing, such as removal of trim, cupboards, shelves, etc., which are not a part of the appliance when it is shipped from the factory.
- 10 Service calls to repair or replace appliance light bulbs, air filters, water filters, other consumable, or knobs, handles, or other cosmetic parts.
- 11 Surcharges including, but not limited to, any after hour, weekend, or holiday service calls, tolls, ferry trip charges, or mileage expense for service calls to remote areas, including the state of Alaska.
- 12 Damages to the finish of appliance or home incurred during installation, including but not limited to floors, cabinets, walls, etc.
- 13 Damages caused by: services performed by unauthorized service companies; use of parts other than genuine Electrolux parts or parts obtained from persons other than authorized service companies; or external causes such as abuse, misuse, inadequate power supply, accidents, fires, or acts of God.

DISCLAIMER OF IMPLIED WARRANTIES; LIMITATION OF REMEDIES

Customer's sole and exclusive remedy under this limited warranty shall be product repair or replacement as provided herein. Claims based on implied warranties, including warranties of merchantability or fitness for particular purpose, are limited to one year or the shortest period allowed by law, but not less than one year. Electrolux shall not be liable for consequential or incidental damages such as property damage and incidental expenses resulting from any breach of this written limited warranty or any implied warranty. Some states and provinces do not allow the exclusion or limitation of incidental or consequential damages, or limitations on the duration of implied warranties, so these limitations or exclusions may not apply to you. This written warranty gives you specific legal rights. You may also have other rights that vary from state to state.

If You Need Service

Keep your receipt, delivery slip, or some other appropriate payment record to establish the warranty period should service be required. If service is performed, it is in your best interest to obtain and keep all receipts. Service under this warranty must be obtained contacting Electrolux at the addresses or phone numbers below.

This warranty only applies in the USA and Canada. In the USA, your appliance is warranted by Electrolux Major Appliances North America, a division of Electrolux Home Products, Inc. In Canada, your appliance is warranted by Electrolux Canada Corp. Electrolux authorizes no person to change or add to any obligations under this warranty. Obligations for service and parts under this warranty must be performed by Electrolux or an authorized service company. Product features or specifications as described or illustrated are subject to change without notice.

USA
1.800.944.9044
Electrolux Major Appliances
North America
P.O. Box 212378
Augusta, GA 30907



Canada
1.800.265.8352
Electrolux Canada Corp.
5855 Terry Fox Way
Mississauga, Ontario, Canada
L5V 3E4