

# REAR VIEW

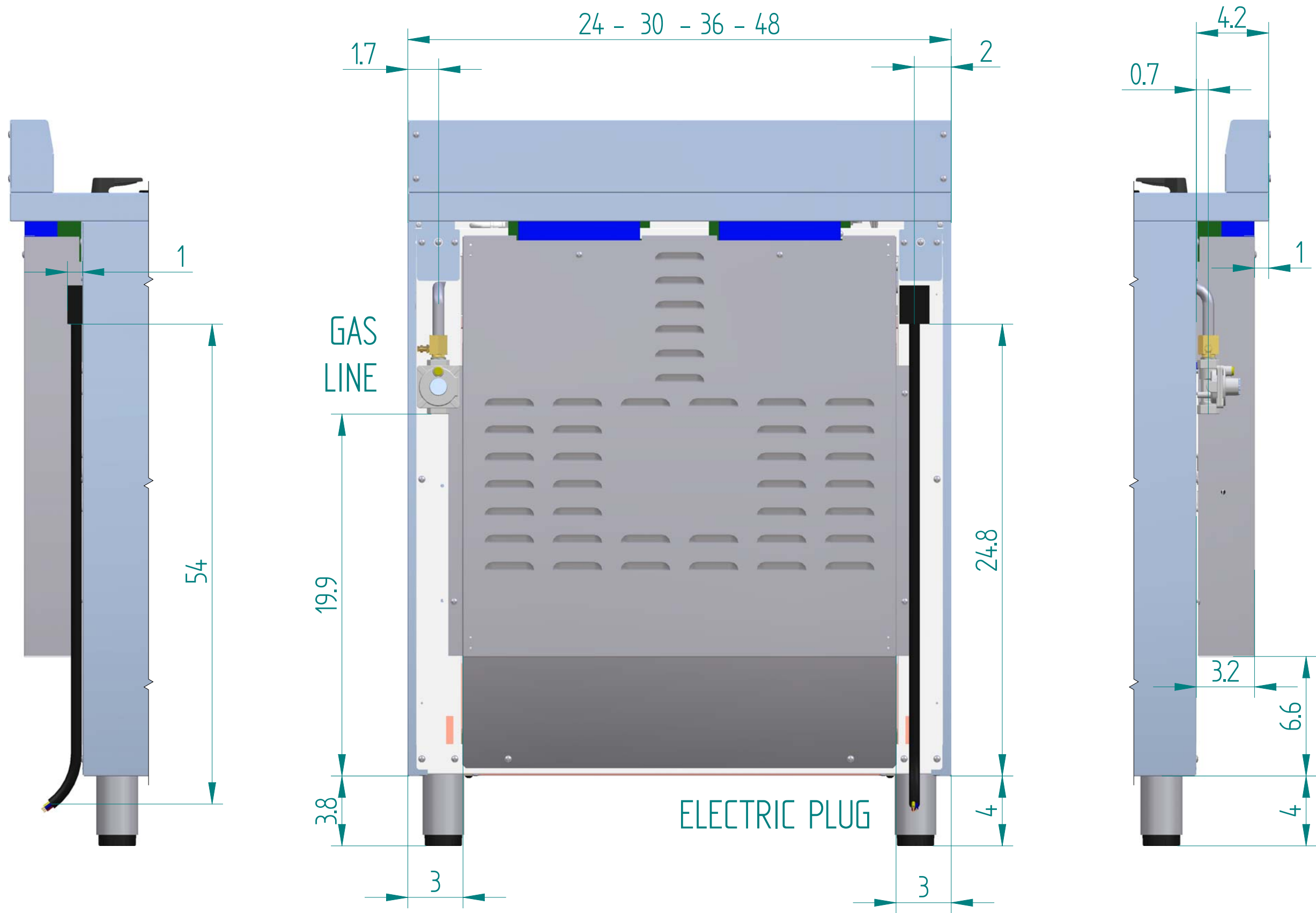

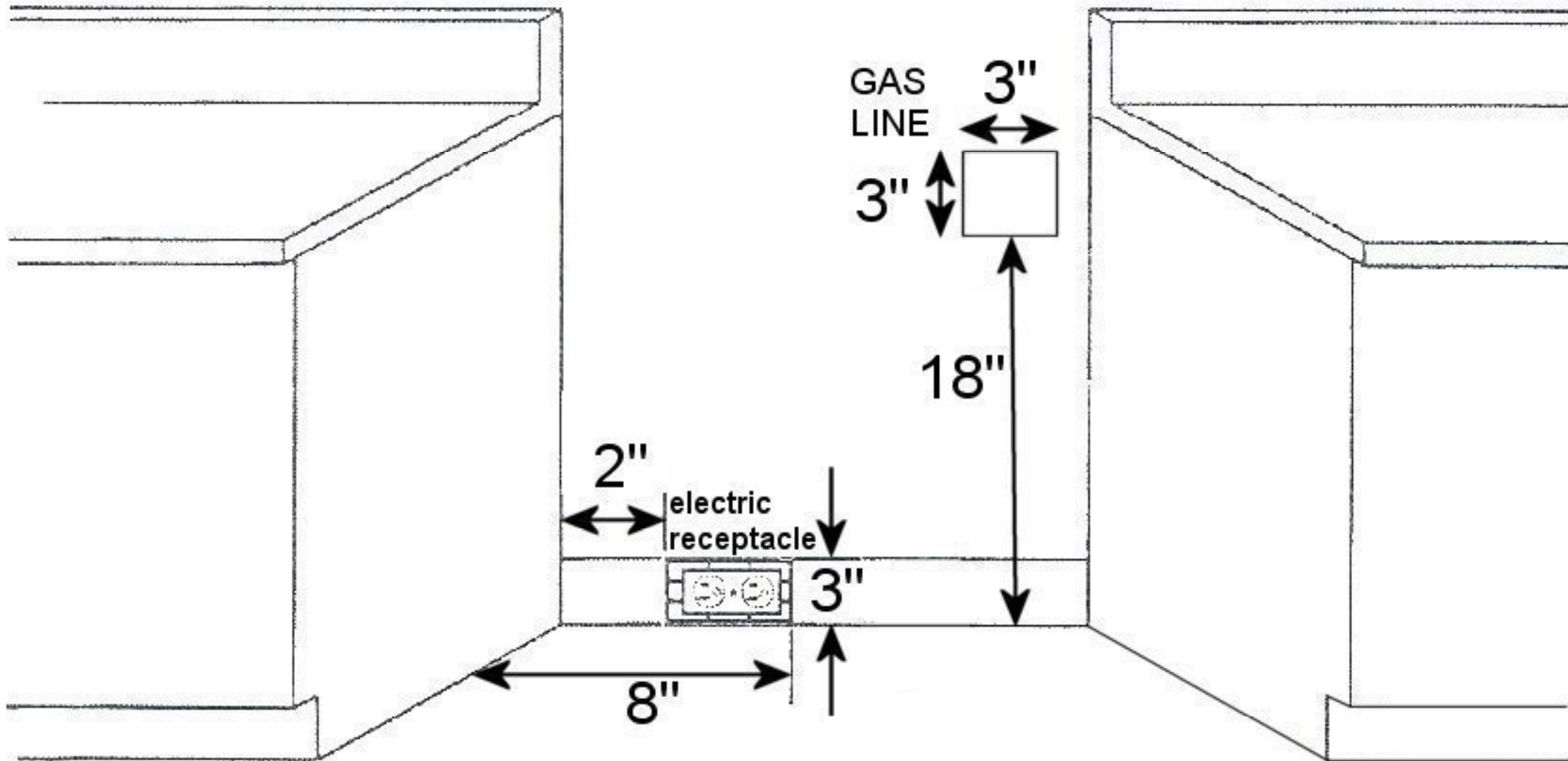

**\*NOTE:** Ground plug and electrical wire toward the direction of the electrical outlet

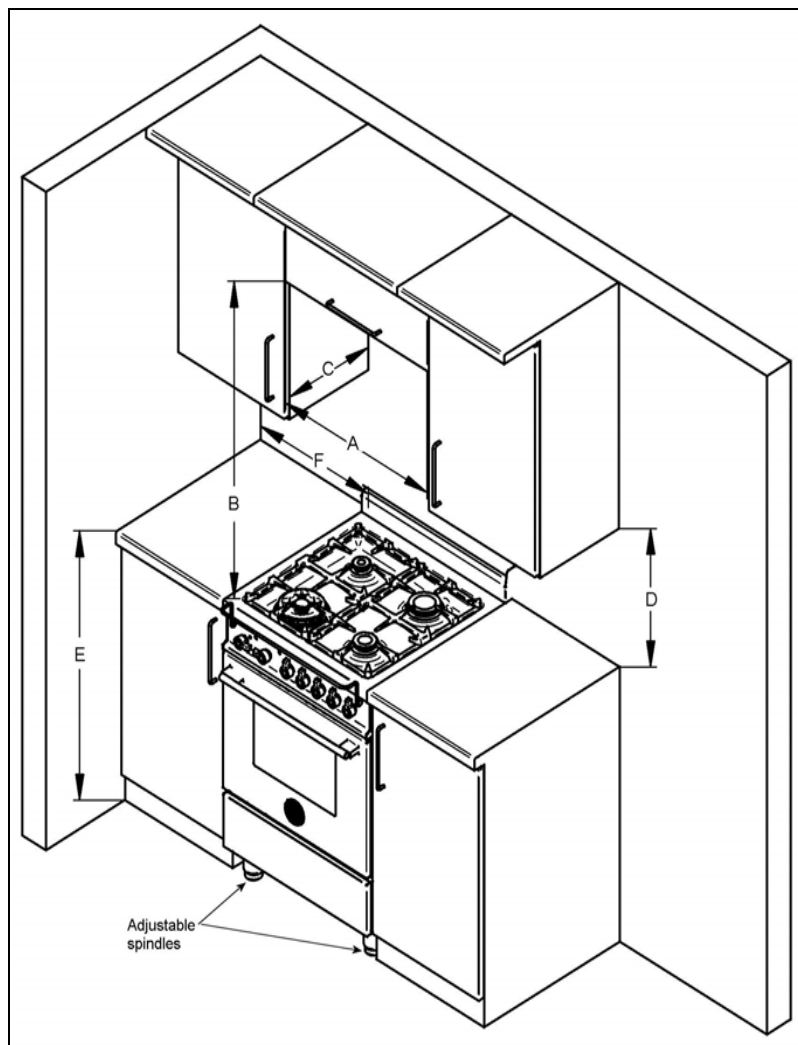

A	24" (61 cm)
B	36" (91,5 cm)
C	13" (33,0 cm)
D	18" (45,7 cm)
E	35" <sup>1</sup> / <sub>2</sub> (90,2 cm) / 37" <sup>1</sup> / <sub>4</sub> (94,6 cm)
F	6" (15,2 cm)

