

Tilt

ATI-M90ASX
ATI-M90ABX

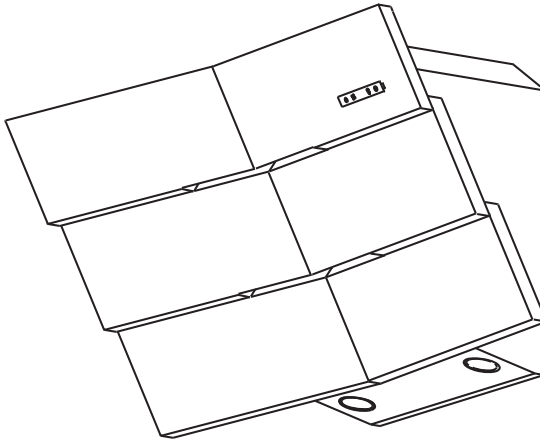

F HOTTE PER CUISINE - Notice d'utilisation...Pag. 23

E CAMPANA EXTRACTORA - Manual de utilización...Pag. 45

I CAPPASPIRANTE - istruzioni per l'uso...Pag. 67

SAFETY INSTRUCTIONS.....pag. 4

LIST OF MATERIALS.....pag. 7

DUCTING CALCULATION SHEETS.....pag. 8

HOOD SPECIFICATION.....pag. 9

INSTALLATION

- **INTERNAL BLOWER.....pag. 10**
- **EXTERNAL & IN-LINE BLOWER PREPARATION.....pag. 13**
- **DUCTING OPTIONS.....pag. 16**
- **MOUNTING THE RANGE HOOD.....pag. 17**
- **POWER SUPPLY CONNECTION.....pag. 19**

MAINTENANCE.....pag. 20

LIST OF PARTS AND ACCESSORIES.....pag. 21

Safety instructions

■ IMPORTANT SAFETY INSTRUCTIONS

■ FOR RESIDENTIAL USE ONLY

■ READ AND SAVE THESE INSTRUCTIONS

■ PLEASE READ ENTIRE INSTRUCTIONS BEFORE PROCEEDING.

■ **IMPORTANT:** Save these Instructions for the Local Electrical Inspectors use.

■ **INSTALLER:** Please leave these Instructions with this unit for the owner.

■ **OWNER:** Please retain these instructions for future reference.

■ Take care when using cleaning agents or detergents.

■ Suitable for use in household cooking area

■ **WARNING** - To reduce the risk of fire or electric shock, do not use this fan with any Solid-State Speed Control Device.

■ **CAUTION** - To reduce risk of fire and to properly exhaust air, be sure to duct air outside – Do not vent exhaust air into spaces within walls or ceilings or into attics, crawl spaces, or garages.

■ **CAUTION** - For general ventilating use only. Do not use to exhaust hazardous or explosive materials and vapors.

■ **CAUTION** - To avoid motor bearing damage and noisy and/or unbalanced impellers, keep drywall spray, construction dust, etc. off power unit.

■ **CAUTION** - Please read specification label on product for further information and requirements.

■ **WARNING** – TO REDUCE THE RISK OF FIRE, ELECTRIC SHOCK, OR INJURY TO PERSONS, OBSERVE THE FOLLOWING:

A. Use this unit only in the manner intended by the manufacturer. If you have questions, contact the manufacturer.

B. Before servicing or cleaning unit, switch power off at service panel and lock the service disconnecting means to prevent power from being switched on accidentally. When the service disconnecting means cannot be locked, securely fasten a prominent warning device, such as a tag, to the service panel.

■ **WARNING - TO REDUCE THE RISK OF A RANGE TOP GREASE FIRE:**

A. Never leave surface units unattended at high settings. Boilovers cause smoking and greasy spillovers that may ignite. Heat oils slowly on low or medium

settings.

- B.** Always turn hood ON when cooking at high heat or when flambeing foods (i.e. Crepes Suzette, Cherries Jubilee, Peppercorn Beef Flambe).
- C.** Clean ventilating fans frequently. Grease should not be allowed to accumulate on fan or filter.
- D.** Use proper pan size. Always use cookware appropriate for the size of the surface element.
- E.** Keep fan, filters and grease laden surface clean.
- F.** Use high range setting on range only when necessary. Heat oil slowly on low to medium setting.
- G.** Don't leave range unattended when cooking.
- H.** Always use cookware and utensils appropriate for the type and amount of food being prepared.

■ **WARNING** – TO REDUCE THE RISK OF INJURY TO PERSONS IN THE EVENT OF A RANGE TOP GREASE FIRE, OBSERVE THE FOLLOWING:

- A.** SMOTHER FLAMES with a close-fitting lid, cookie sheet, or metal tray, then turn off the burner. BE CAREFUL TO PREVENT BURNS. If the flames do not go out immediately, EVACUATE AND CALL THE FIRE DEPARTMENT.
 - B.** NEVER PICK UP A FLAMING PAN – You may be burned.
 - C.** DO NOT USE WATER, including wet dishcloths or towels – a violent steam explosion will result.
 - D.** Use an extinguisher ONLY if:
 1. You know you have a Class ABC extinguisher, and you already know how to operate it.
 2. The fire is small and contained in the area where it started.
 3. The fire department is being called.
 4. You can fight the fire with your back to an exit.
- aBased on "kitchen firesafety tips" published by NFPA

Proper maintenance of the Range Hood will assure proper performance of the unit.

■ INSTALLATION INSTRUCTIONS

WARNING – TO REDUCE THE RISK OF FIRE, ELECTRIC SHOCK, OR INJURY TO PERSONS, OBSERVE THE FOLLOWING:

- A.** Installation work and electrical wiring must be done by qualified person(s) in accordance with all applicable codes and standards, including fire-rated construction.
- B.** Sufficient air is needed for proper combustion and exhausting of gases

Safety instructions

through the flue (chimney) of fuel burning equipment to prevent back drafting. Follow the heating equipment manufacturer's guideline and safety standards such as those published by the National Fire Protection Association (NFPA), and the American Society for Heating, Refrigeration and Air Conditioning Engineers (ASHRAE), and the local code authorities.

C. When cutting or drilling into wall or ceiling, do not damage electrical wiring and other hidden utilities.

D. Ducted fans must always be vented to the outdoors.

E. This unit must be grounded.

■ **WARNING** - TO REDUCE THE RISK OF FIRE, USE ONLY METAL DUCTWORK.

■ **WARNING** - UNDER CERTAIN CIRCUMSTANCES DOMESTIC APPLIANCES MAY BE DANGEROUS.

A. Do not check filters with hood working.

B. Do not touch the lamps after a prolonged use of the appliance.

C. No food must be cooked flambè underneath the hood.





D. The use of an unprotected flame is dangerous for the filters and could cause fires.

E. Watch constantly the fried food in order to avoid the cooking oil flares up.

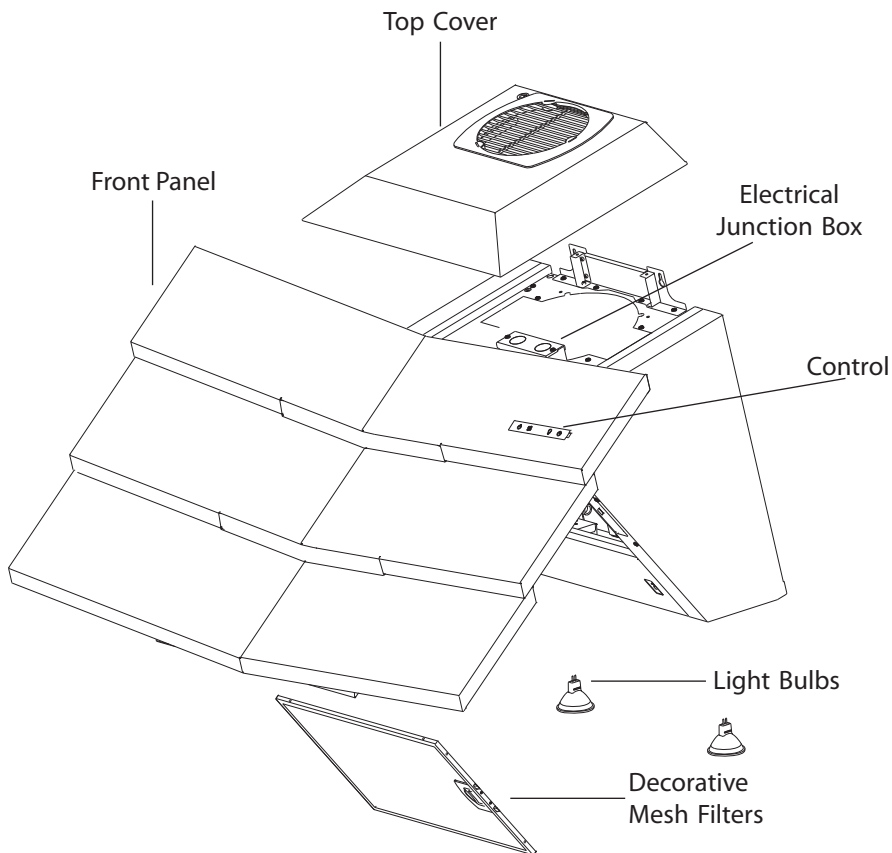









F. before performing any maintenance operation, disconnect the hood from the electrical service.











■ The manufacturers will not to accept any responsibility for eventual damages, because of failure to observe the above instructions.



TYPE		DESCRIPTION	N°
A		M4	1 + 1
B		1/8" x 1/4"	12
C		1/8" x 2/4"	4
D		1/4" x 2-3/4"	6

Ducting Calculation Sheet

duct pieces		Equivalent number length x used =	Total
	3-1/4" x 10" Rect., straight	1 Ft. x () =	Ft.
	7" Round, straight	1 Ft. x () =	Ft.
	8" Round, straight	1 Ft. x () =	Ft.
	3-1/4" x 10" Rect. 90° elbow	15 Ft. x () =	Ft.
	3-1/4" x 10" Rect. 45° elbow	9 Ft. x () =	Ft.
	3-1/4" x 10" Rect. 90° flat elbow	24 Ft. x () =	Ft.
	3-1/4" x 10" Rect. wall cap with damper	30 Ft. x () =	Ft.
	3-1/4" x 10" Rect. to 6" round transition	5 Ft. x () =	Ft.
	3-1/4" x 10" Rect. to 6" round transition 90° elbow	20 Ft. x () =	Ft.
	6" Round, 90° elbow	15 Ft. x () =	Ft.
	6" Round, 45° elbow	9 Ft. x () =	Ft.
Subtotal column 1 =			Ft.

duct pieces		Equivalent number length x used =	Total
	6"- 8" Round wall cap with damper	30 Ft. x () =	Ft.
	6"- 8" Round, roof cap	30 Ft. x () =	Ft.
	6" round to 3-1/4" x 10" rect. transition	1 Ft. x () =	Ft.
	6" round to 3-1/4" x 10" rect. transition 90° elbow	16 Ft. x () =	Ft.
	7" or 8" Round, 90° elbow	15 Ft. x () =	Ft.
	7" or 8" Round, 45° elbow	9 Ft. x () =	Ft.
	7" or 8" Round wall cap with damper	30 Ft. x () =	Ft.
	7" or 8" Round, roof cap	30 Ft. x () =	Ft.
	7" round to 3 1/4" x 10" rect. transition	8 Ft. x () =	Ft.
	7" round to 3-1/4" x 10" rect. transition 90° elbow	23 Ft. x () =	Ft.
Subtotal column 2 =			Ft.
Subtotal column 1 =			Ft.
Total Ductwork =			Ft.

Maximum Duct Length:

For satisfactory air movement, the total duct length should not exceed 100 equivalent feet.

front of hood

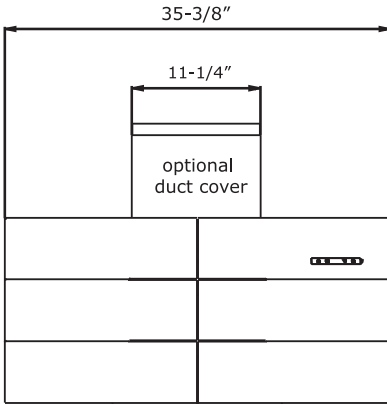

side of hood

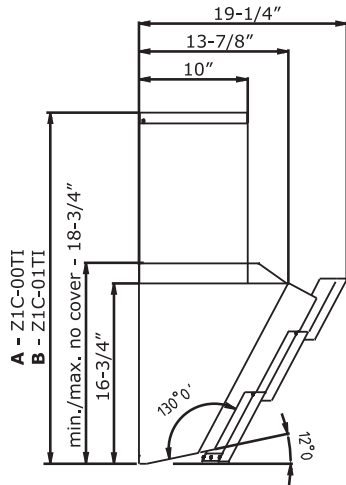

With Optional Duct Cover Accessory
A (8' to 10' ceiling): min. - 35" max. - 52"
B (10' or 12' ceiling): min. - 51" max. - 85"

Hood Specifications

top of hood

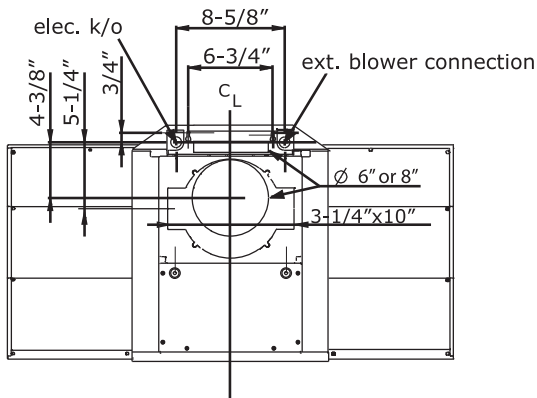

Installation - Internal Blower

■ **NOTE!** The device in this version (with internal suction motor) is equipped for rear discharge of exhaust air. However, if required, it is possible to have the exhaust air discharged from the top. This can be accomplished by following the steps indicated in the following paragraphs; upon reaching step 7, the motor plate must not be rotated, therefore skip steps 8 and 9 and proceed from step 10 directly.

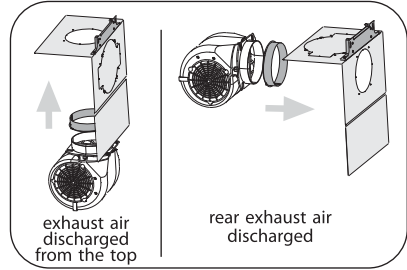

■ The following instructions are for installing the internal blower. **CAUTION:** To reduce the risk of fire and electric shock, install this rangehood only with internal blower models MT-020 provided with the kit code CBI-600A.

For external and in-line blower preparation please turn to page 13.

1. Open the front panel, Fig.1

NOTE! Open the front panel while holding it by its external sides, as shown in Fig.1, and keep at a suitable distance to avoid impacting it.

2. Remove the Decorative Mesh Filters.

3. Loosen the two screws inside the hood that fasten the canopy. Fig.2

4. Slide the top cover off by lifting it. Fig.3

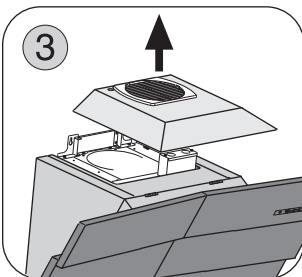
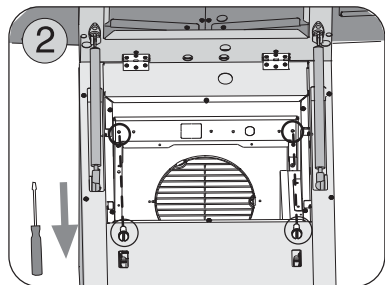
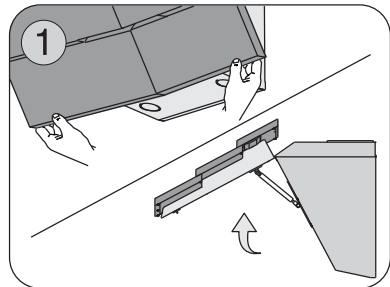

5. Close the front panel while holding it by its external sides until it shuts.

6. Remove the 6" round metal knockout plate from the blower plate by using a flat head screwdriver. See. Fig.4

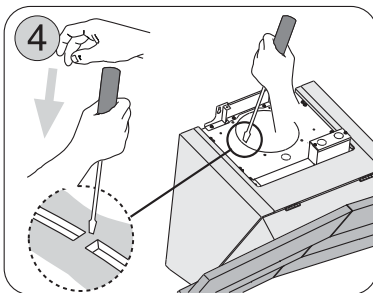

7. Remove the (10) screws securing the blower plate to the blower housing and remove blower plate. See. Fig.5

(Note! If air is discharged from the top, do not rotate the plate; proceed from step 10 instead).

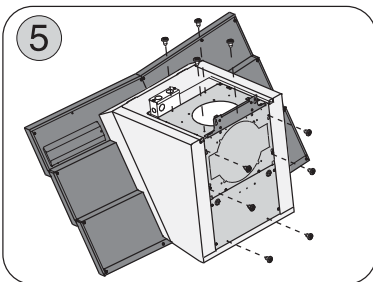

8. Remove the rectangular plate and the fixing bracket from the motor plate by loosening the 6 screws. Fig.6

9. Rotate the motor plate by 90° and fix the rectangular plate and the fixing bracket in the opposite direction as shown in Fig.7

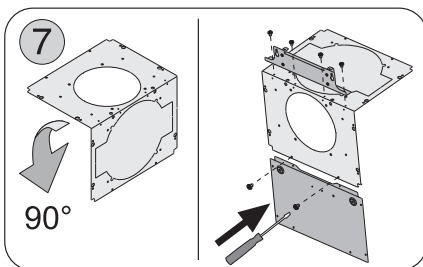
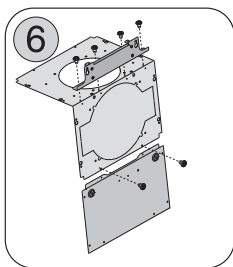

10. Place the 6" metallic flange on the blower's air outlet (the flange may already be pre-installed). Install internal blower into blower plate and secure using (4) screws included with the blower. See Fig. 8

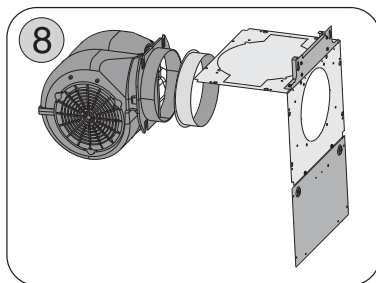

11. Fasten the two brackets to the sides of the motor by fixing them onto the motor plate with (4 type B) screws, and to the sides of the motor with another (4 type C) screws. Fig 9

12. Secure capacitor box connected to the provided cable to the blower plate using (2 type B) screws included with the blower. See fig. 10

Installation - Internal Blower

13. Secure Green/Yellow ground wire connected to the cable to the provided capacitor to blower plate. (type A) Fig. 11

14. Attach the 6 pin male molex connector from blower wire to the 6 pin female molex connector located inside the blower housing. See Fig.12

15. Install the blower and plate on the inside of the blower housing: carry out the instructions at step 3 in reverse order then use the screws provided to complete installation.(Tot. 16 type B) Fig.13

16. Open the flap. Connect 9 pin male molex connector from blower wire to 9 pin female molex connector on the capacitor wire. See Fig. 14

WARNING! Place electrical wiring inside the blower housing.

17. Put the Decorative Mesh Filter back on and close the front panel while holding it by its external sides until it shuts; then put the canopy back on.

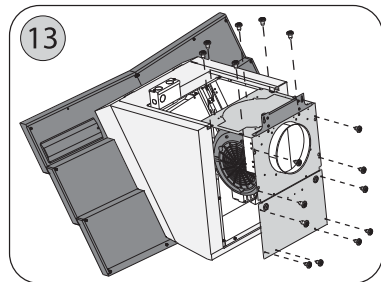
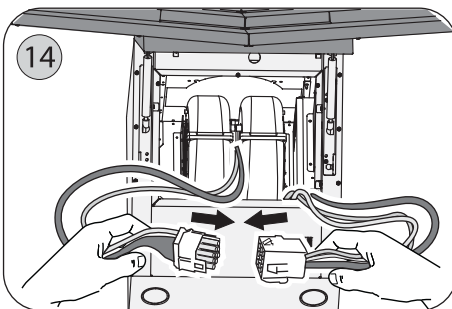
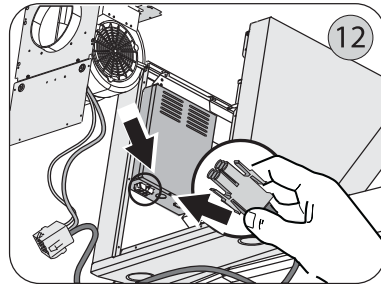
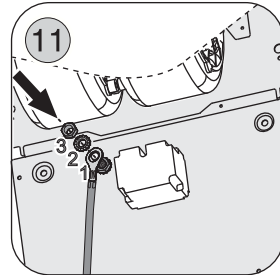
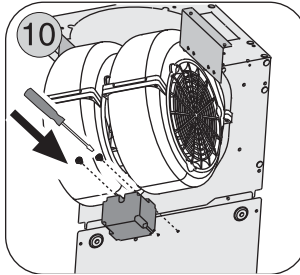
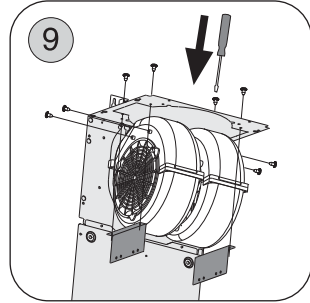

The hood is now ready to be installed on the wall.

■ **NOTE!** The device in this version (with external motor) is equipped for rear discharge of exhaust air. However, if required, it is possible to have the exhaust air discharged from the top. This can be accomplished by carrying out the steps indicated in the following paragraphs; upon reaching step 7, the motor plate must be rotated and installed in the opposite direction.

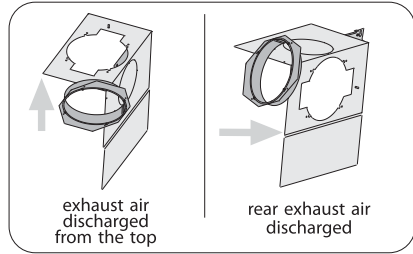

■ The following instructions are for preparing the hood for use with an external or in-line blowers models CBE-1000 or PBN-1000A.

CAUTION: To reduce the risk of fire and electric shock, install this rangehood only with remote blowers rated maximum 6.2 A.

For internal blower instructions please turn to page 10.

1. Open the front panel. Fig.1
- NOTE!** Open the front panel while holding it by its external sides, as shown in Fig.1 , and keep at a suitable distance to avoid impacting it.
2. Remove the Decorative Mesh Filters.
 3. Loosen the two screws inside the hood that fasten the canopy. Fig.2
 4. Slide the top cover off by lifting it. Fig.3

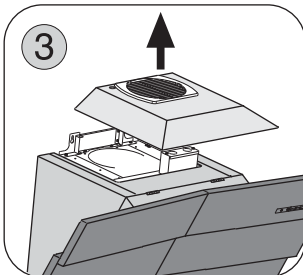
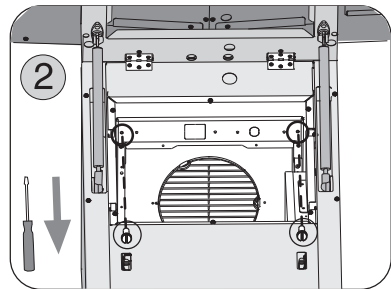
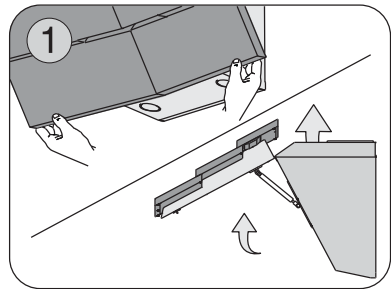

Installation - External & In-Line Blower Preparation

5. Close the front panel while holding it by its external sides until it shuts.

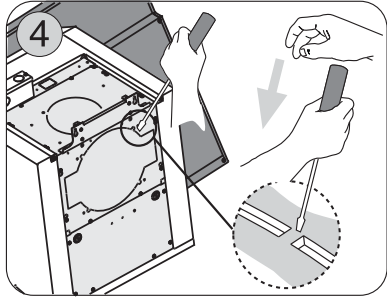

6. Remove the metal motor plate by striking it with the aid of a slotted screwdriver. Fig. 4

7. Remove the (10) screws securing the blower plate to the blower housing and remove blower plate. See Fig.5

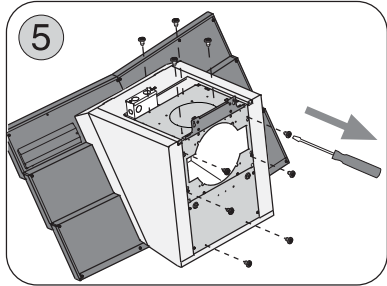

8. (if air is discharged from the top, rotate the motor plate by 90° and fix the rectangular plate and the fixing bracket in the opposite direction.)

Install the chosen flange: rectangular (A) or circular (B), and fix it to the blower plate with the (4 type B) screws. Fig. 6

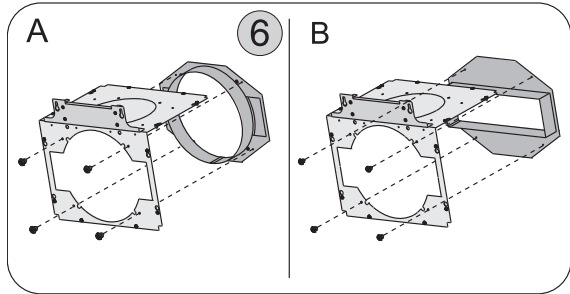

9. Install the plate with the flange facing the wall, inside the motor casing: carry out the instructions at stage 7 in reverse order then use the screws provided to complete installation. (Tot. 16 type B) Fig.7

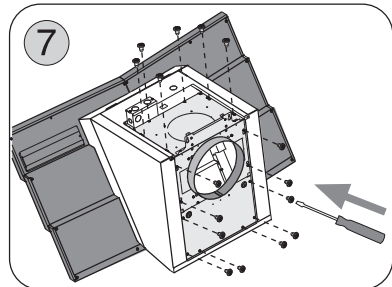

10. Insert the female connector in the terminal box. Fig. 8A. Break the hood grommet with the aid of a slotted screwdriver Fig. 8B. Secure remote blower junction box to top of blower housing using (2) screws. See Fig.9

11. Connect the power supply conduit to the box once the hood has been fixed to the wall (pag.17) . Fig. 10

Note: Carry out the power supply connection in accordance with the national electric code, ANSI/NFPA 70-1999.

Note1: A cable lock (not included) may be required by local codes. Please review local codes for more information.

12. Attach 6 pin male moxex connectors to 6 pin female moxex connectors inside blower housing. See Fig 11

Note2: Check local codes to determine minimum wire gauge.

See manual included with external and in-line blower for instructions on installing the blower

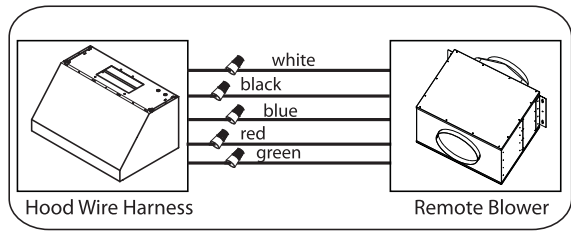
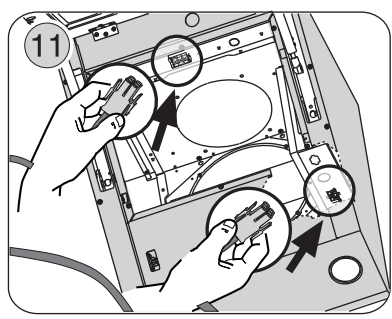
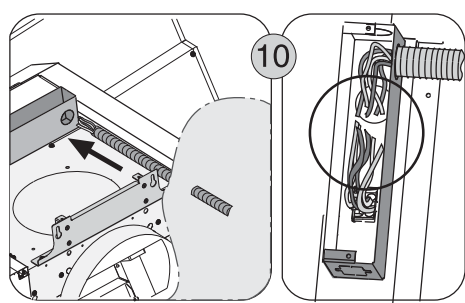
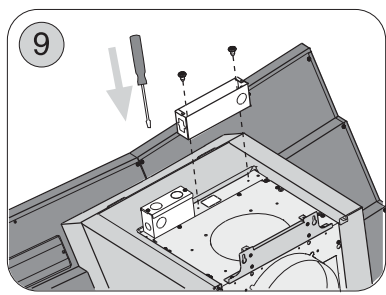
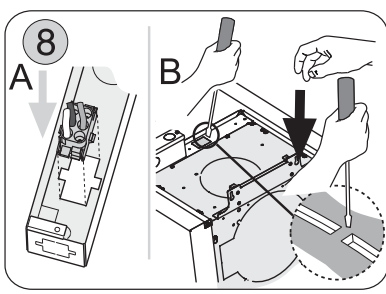

Installation - Ducting Options

■ WARNING FIRE HAZARD

NEVER exhaust air or terminate duct work into spaces between walls, crawl spaces, ceiling, attics or garages.

All exhaust must be ducted to the outside, unless using the recirculating option.

Use single wall rigid Metal ductwork only.

Fasten all connections with sheet metal screws and tape all joints w/ certified Silver Tape or Duct Tape.

Some Ducting Options

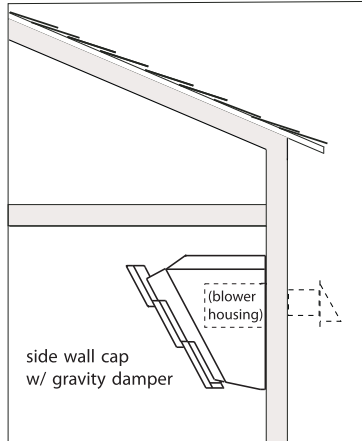
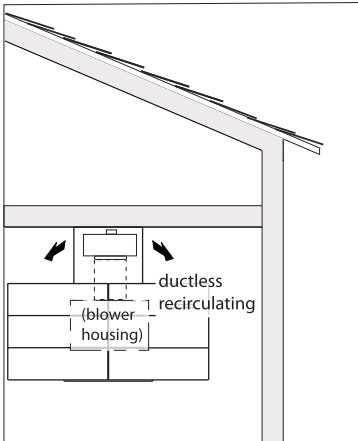
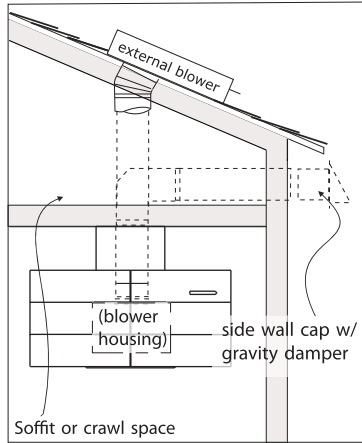
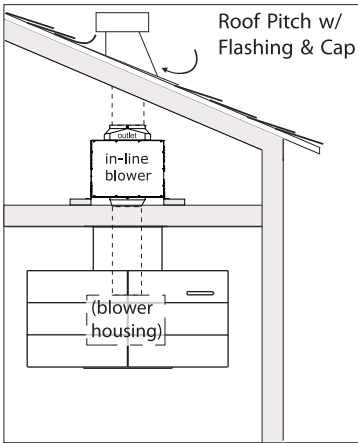

■ MOUNTING HEIGHTS

The range hood must be installed at a minimum height of 22 inches (56 cm) from the cooking surface. If a connecting duct work composed of two parts is used, the upper part must be placed outside the lower part. Do not connect the range hood duct to the same duct used to exhaust hot air or fumes from another appliance. Before proceeding with the assembly instructions remove the decorative mesh filters so that the range hood is easier to handle.

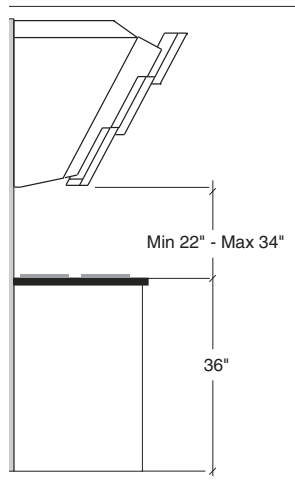

■ MOUNTING TO THE WALL

1. Place the paper template included with your hood on the wall to determine where to add the screws for mounting the hood.

Make sure that the line at the bottom of the template is aligned with the edge of the rear lower corner of the hood. Fig. 15

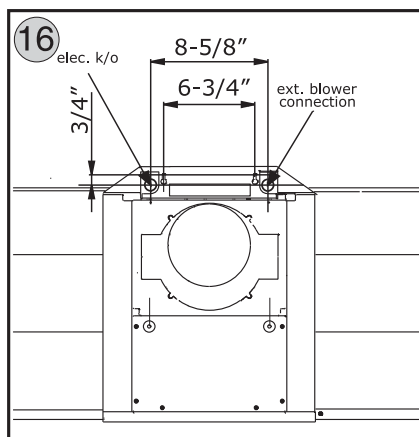
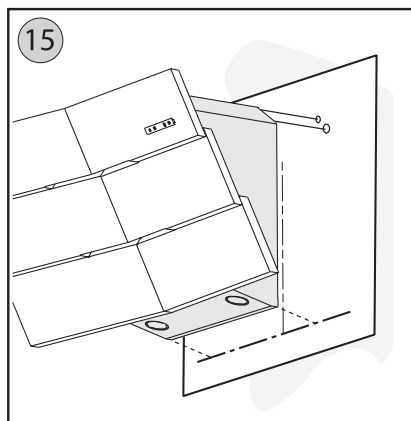

Note! Cut out holes for ducting if venting out the back. Drill holes for the power supply and the remote blower power supply (if required), using the measurements indicated in Fig. 16.

2. Lift the hood onto the (2 type D) screws and adjust to make sure the hood is level.

Installation - Mounting the Range Hood

WARNING: In order to facilitate their connection, make sure that the power supply conduits are not obstructed by the hood.

3. When the hood has been adjusted tighten the screws to secure the hood in place.
4. Once the adjustment has been completed, fix the hood definitely using another (2 type D) screws.

NOTE: Screws must be fastened into wooden studs so wood blocking may be necessary. If using wall anchors make sure to check your local codes for suitability and type of anchors to use.

NOTE1: For the various installations use screws and screw anchors suited to the type of wall (minimum screw size: 1/4" diameter x 2-3/4" length).

NOTE2: The following Duct Cover kits are available as accessories: Z1C-00TI, Z1C-01TI

■ **GENERAL**

• Carefully read the following important information regarding installation safety and maintenance. Keep this information booklet accessible for further consultations.

■ **POWER SUPPLY CONNECTION**

For connection to the power supply refer to the following:

1. Remove the power supply cover by undoing the (2) screws Fig. 17.
2. Break through the hole on the box.
3. Pass the wires through the hole in the box and fasten the power supply conduit. Fig.18
4. Connect the wires of the hood to those of the power supply as described. Fig.19 :

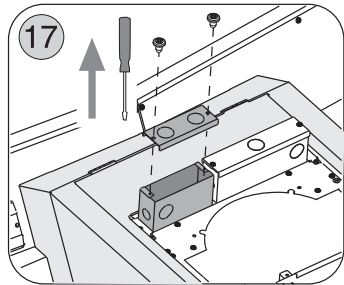

BLACK = **L** line
WHITE = **N** neutral
GREEN / YELLOW = **G** ground

- A double-pole switch properly rated must be installed to provide the range hood power supply disconnection.

- Connect the electrical conduit to the Field Wiring Compartment using listed conduit fittings.

- Carry out the power supply connection in accordance with the national electric code, ANSI/NFPA 70-1999.

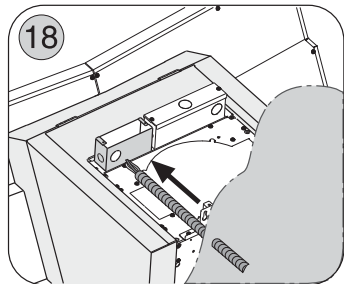

5. Insert the wires into the box, then close the box cover, securing it using the screws that were previously removed.

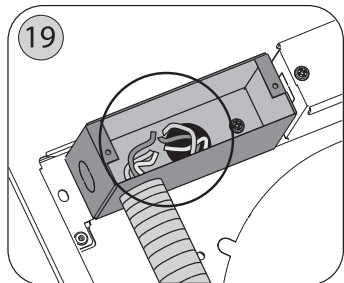

6. Put the Decorative Mesh Filter back on and close the front panel while holding it by its external sides until it shuts; then put the canopy back on.

■ **MAINTENANCE**

- It is recommended to operate the appliance prior to cooking. It is recommended to leave the appliance in operation for 5 minutes after cooking is completed in order to completely eliminate cooking vapors and odors. The proper function of the range hood is conditioned by the regularity of maintenance.
- The decorative mesh filters capture the grease particles suspended in the air and are therefore subject to clogging because of frequent use. In order to prevent a fire hazard, it is recommended to clean the filter a minimum of every 2 months or when instructed by the Metal Filter Clean indicator on the range hood controls. Clean the range hood by carrying out the following instructions:
 - Remove the filters from the range hood and wash them in a solution of water and neutral liquid detergent, leaving to soak.
 - Rinse thoroughly with warm water and leave to dry.
 - Filters may also be washed in the dishwasher at the lowest setting. The filters may alter in color after several washes but is not cause for replacement.
- Clean the blower and other surfaces of the range hood regularly using a cloth moistened with denatured alcohol or non abrasive liquid detergent.

DESCRIPTION	HOOD	PART#
REPLACEMENT PARTS		
Light Bulb GU5, 20W (each)	ATI	Z0B0031
OPTIONAL ACCESSORIES		
Recirculating Kit	ATI	ZRC-00HZ
Replacement Charcoal Filters	ATI	Z0F-00AC
Short Duct Cover (8"-9" ceiling)	ATI	Z1C-00TI
Long Duct Cover (9"-10" ceiling)	ATI	Z1C-01TI

To order parts, visit us online at <http://store.zephyronline.com> or call us at 1.888.880.8368



3LIK0505