

**E SERIES BUILT-IN OVENS**



**INSTALLATION INSTRUCTIONS**





## CONTACT INFORMATION

**Wolf Customer  
Service:**  
800-332-9513

**Website:**  
wolfappliance.com

As you follow these instructions, you will notice **WARNING** and **CAUTION** symbols. This blocked information is important for the safe and efficient installation of Wolf equipment. There are two types of potential hazards that may occur during installation.

### **⚠ CAUTION**

signals a situation where minor injury or product damage may occur if you do not follow instructions.

### **⚠ WARNING**

states a hazard that may cause serious injury or death if precautions are not followed.

Another footnote we would like to identify is **IMPORTANT NOTE**: This highlights information that is especially relevant to a problem-free installation.



**INSTALLATION** REQUIREMENTS

**IMPORTANT NOTE:** This installation must be completed by a qualified technician.

**IMPORTANT NOTE:** Save these Installation Instructions for the local inspector's use.

- Please read the entire Installation Instructions prior to installation.
- **Installer:** please retain these instructions for local inspector's reference, then leave them with the homeowner.
- **Homeowner:** please read and keep these instructions for future reference and be sure to read the entire Use & Care Information prior to use.

**IMPORTANT NOTE:** This appliance must be installed in accordance with National Electrical Codes, as well as all state, municipal and local codes. The correct voltage, frequency and amperage must be supplied to the appliance from a dedicated, grounded circuit which is protected by a properly sized circuit breaker or time delay fuse. The proper voltage, frequency, and amperage ratings are listed on the product rating plate.

Record the model and serial numbers before installing the built-in oven. Both numbers are listed on the rating plate, located on the right side of the oven trim, directly above the door. Open the oven door to view the rating plate. Refer to the illustration below.

**SITE** PREPARATION

**IMPORTANT NOTE:** A minimum 24" (610) of usable cabinet depth is required, or the back panel of the cabinet may need to be removed for proper installation. A minimum 25" (635) of usable cabinet depth is required for a flush inset installation. The electrical box must be flush with the back panel of the cabinet.

The installation opening must have a flat, level base platform to support the oven. Single ovens require a minimum base support of 250 lbs (113 kg) and double ovens require a minimum base support of 400 lbs (181 kg).

**IMPORTANT NOTE:** Wolf built-in ovens are designed and agency approved for installation with Wolf cooktops, microwaves and warming drawers only. The nominal width of the built-in oven should match the nominal width of the cooktop. A built-in oven cannot be installed below a Wolf rangetop.

RATING PLATE INFORMATION

**Model Number**

**Serial Number**

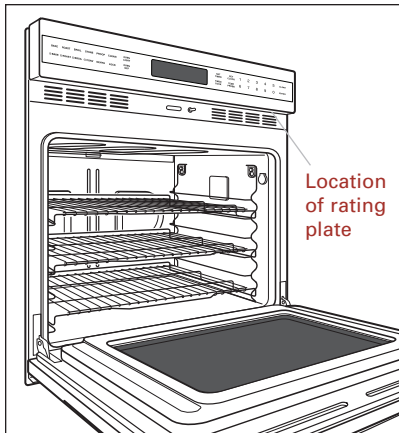

**Rating plate location**



E SERIES BUILT-IN SINGLE OVENS

MODELS SO30-2F/S AND SO30-2U/S

**IMPORTANT NOTE:** A minimum 24" (610) of usable cabinet depth is required, or the back panel of the cabinet may need to be removed for proper installation. A minimum 25" (635) of usable cabinet depth is required for a flush inset installation. The electrical box must be flush with the back panel of the cabinet.

**IMPORTANT NOTE:** Unless you are using cabinets deeper than 24" (610) for a standard installation or 25" (635) for a flush inset installation, it is recommended that the electrical supply be placed in an adjacent cabinet within reach of the conduit. Choose the location shown in the installation illustrations on pages 6–7 that best suits your installation.

For ease of installation, Wolf recommends using 33" (838) wide cabinets with the E Series single oven. A minimum 33" (838) wide cabinet is required for a flush inset installation. The cabinet base platform must be able to support 250 lbs (113 kg).

Refer to the following illustrations for overall dimensions, installation specifications and electrical location for the E Series single oven.

The E Series single oven requires a separate, grounded 3-wire 240/208 V AC, 60 Hz, 30 amp service with its own circuit breaker. It is provided with a 4' (1.2 m) flexible 3-wire conduit, which can make a connection at an electrical box. Refer to Electrical Requirements on page 14. The oven is not supplied with an electrical plug.

OVERALL DIMENSIONS – MODELS SO30-2F/S AND SO30-2U/S

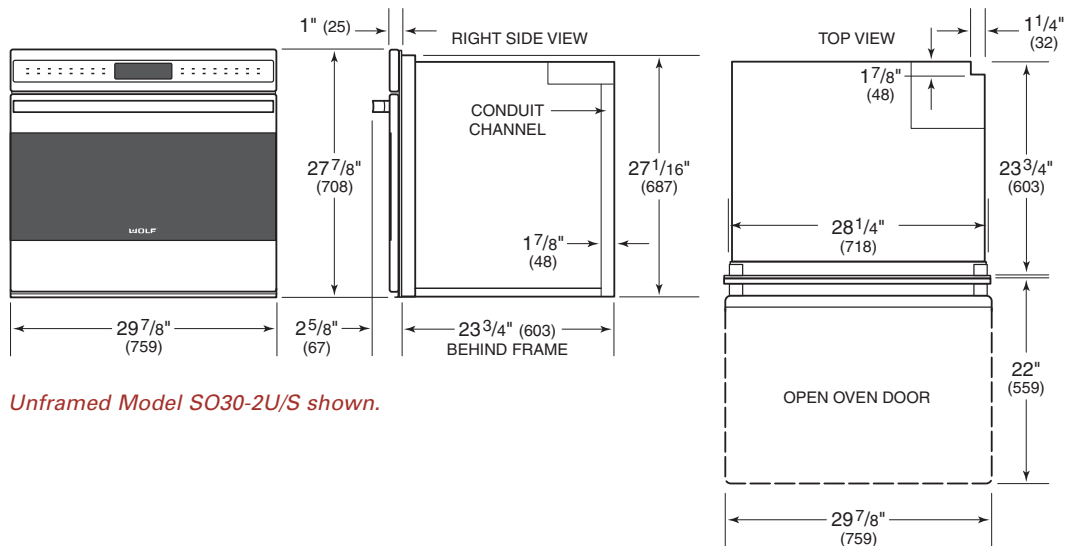



## E SERIES BUILT-IN SINGLE OVENS

### STANDARD INSTALLATION

**IMPORTANT NOTE:** For standard installations, a minimum 24" (610) of usable cabinet depth is required, or the back panel of the cabinet may need to be removed for proper installation. The electrical box must be flush with the back panel of the cabinet.

For standard installations, the E Series built-in oven is installed by inserting into cabinetry from the front. The oven has a face trim on all four sides and will overlap stiles and rails. The trim overlaps  $\frac{1}{8}$ " (3) on the bottom,  $\frac{5}{8}$ " (8) on the top and  $\frac{3}{4}$ " (19) on each side.

### FLUSH INSET INSTALLATION

**IMPORTANT NOTE:** For flush inset installations, a minimum 25" (635) of usable cabinet depth is required, or the back panel of the cabinet may need to be removed for proper installation. The electrical box must be flush with the back panel of the cabinet.

The flush inset installation requires the built-in oven to be recessed into the cabinet. A minimum 33" (838) wide and 25" (635) deep cabinet is needed if you want the front of the oven to be flush with surrounding cabinetry.

**IMPORTANT NOTE:** For flush inset installations, the inside edges of the rough opening must be finished, as they will be exposed when the oven door is open. These edges should be stained instead of having a laminated surface, to avoid damage from high temperatures during self-clean.

### COMBINATION INSTALLATIONS

The Wolf E Series single oven may be installed below a Wolf 30" (762) induction, electric or gas cooktop. Unless you are using cabinets deeper than 24" (610) for a standard installation or 25" (635) for a flush inset installation, it is recommended that the electrical supply be placed in the base cabinet to the right of the oven. The E Series single oven may also be installed below a Wolf 36" (914) induction, electric or gas cooktop.

A Wolf E Series single oven may be installed next to another E Series single oven. You must allow for a 2 $\frac{1}{2}$ " (64) space between the oven rough openings. Also, a separate inner wall is required for each oven between openings.



E SERIES BUILT-IN SINGLE OVENS

STANDARD INSTALLATION

Overall Oven Width	29 <sup>7</sup> / <sub>8</sub> " (759)	Minimum Cabinet Width	30" (762)
Overall Oven Height	27 <sup>7</sup> / <sub>8</sub> " (708)	Minimum Cabinet (Opening) Depth	24" (610)
Overall Oven Depth (behind frame)	23 <sup>3</sup> / <sub>4</sub> " (603)	Opening Width	28 <sup>1</sup> / <sub>2</sub> " (724)
Open Door Clearance	22" (559)	Opening Height	27 <sup>3</sup> / <sub>16</sub> " (691)
Recommended Cabinet Width	33" (838)	Minimum Base Support	250 lbs (113 kg)

STANDARD INSTALLATION – MODELS SO30-2F/S AND SO30-2U/S

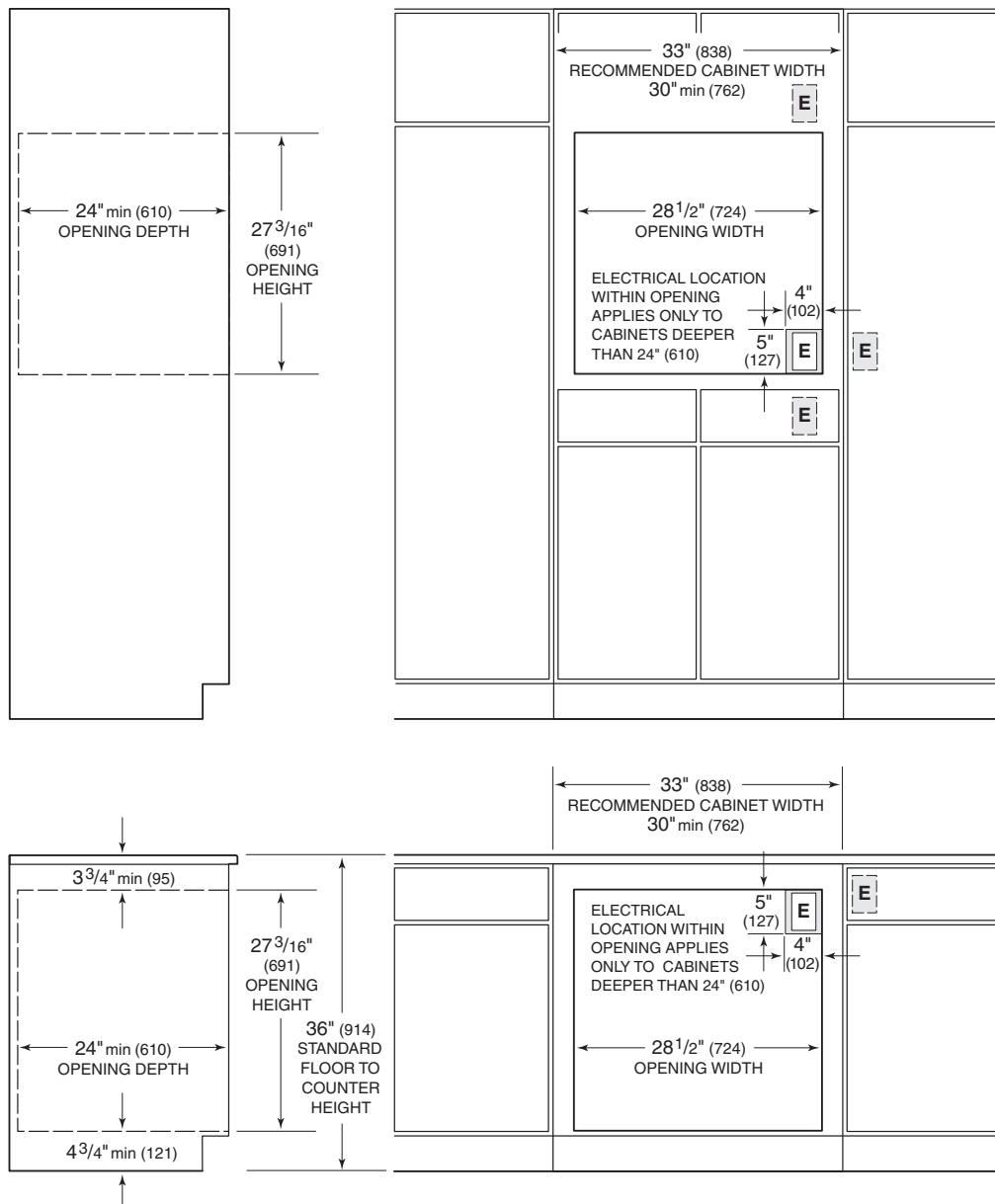



E SERIES BUILT-IN SINGLE OVENS

FLUSH INSET INSTALLATION

Overall Oven Width	29 <sup>7</sup> / <sub>8</sub> " (759)
Overall Oven Height	27 <sup>7</sup> / <sub>8</sub> " (708)
Overall Oven Depth (behind frame)	23 <sup>3</sup> / <sub>4</sub> " (603)
Open Door Clearance	22" (559)
Minimum Base Support	250 lbs (113 kg)

Minimum Cabinet Width	33" (838)
Minimum Flush Inset Depth	25" (635)
Opening Width	28 <sup>1</sup> / <sub>2</sub> " (724)
Minimum Flush Inset Width	30 <sup>3</sup> / <sub>8</sub> " (772)
Opening Height	27 <sup>3</sup> / <sub>16</sub> " (691)
Minimum Flush Inset Height	28 <sup>1</sup> / <sub>2</sub> " (724)

IMPORTANT NOTE

For flush inset installations, the inside edges of the rough opening must be finished, as they will be exposed when the oven door is open.

FLUSH INSET INSTALLATION – MODELS SO30-2F/S AND SO30-2U/S

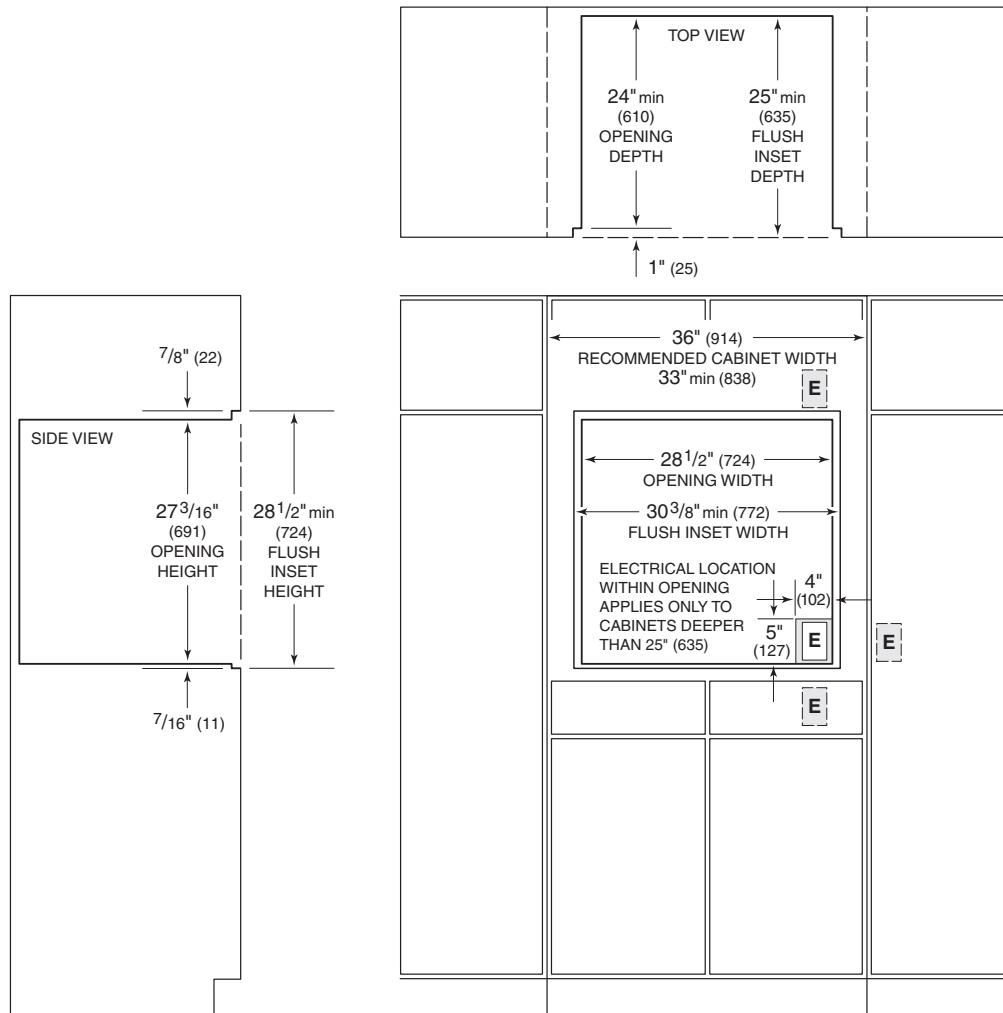

Dimensions in parentheses are in millimeters unless otherwise specified.



E SERIES BUILT-IN DOUBLE OVENS

MODELS DO30-2F/S AND DO30-2U/S

**IMPORTANT NOTE:** A minimum 24" (610) of usable cabinet depth is required, or the back panel of the cabinet may need to be removed for proper installation. A minimum 25" (635) of usable cabinet depth is required for a flush inset installation. The electrical box must be flush with the back panel of the cabinet.

**IMPORTANT NOTE:** Unless you are using cabinets deeper than 24" (610) for a standard installation or 25" (635) for a flush inset installation, it is recommended that the electrical supply be placed in an adjacent cabinet within reach of the conduit. Choose the location shown in the installation illustrations on pages 10–11 that best suits your installation.

For ease of installation, Wolf recommends using 33" (838) wide cabinets with the E Series double oven. A minimum 33" (838) wide cabinet is required for a flush inset installation. The cabinet base platform must be able to support 400 lbs (181 kg).

Refer to the following illustrations for overall dimensions, installation specifications and electrical location for the E Series double oven.

The E Series double oven requires a separate, grounded 3-wire 240/208 V AC, 60 Hz, 50 amp service with its own circuit breaker. It is provided with a 5' (1.5 m) flexible 3-wire conduit, which can make a connection at an electrical box. Refer to Electrical Requirements on page 14. The oven is not supplied with an electrical plug.

OVERALL DIMENSIONS – MODELS DO30-2F/S AND DO30-2U/S

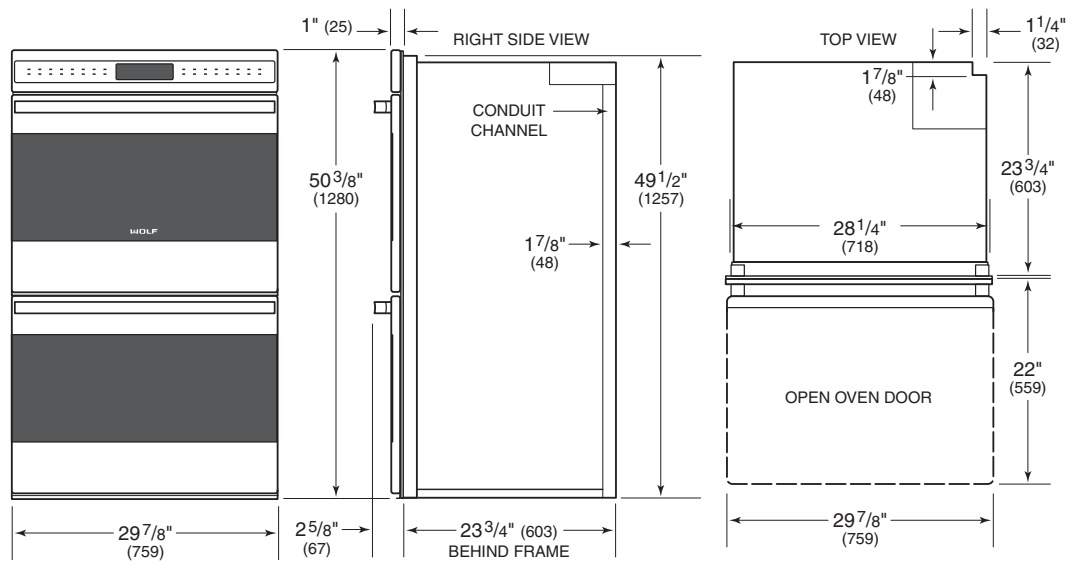

Unframed Model DO30-2U/S shown.





## E SERIES BUILT-IN DOUBLE OVENS

### STANDARD INSTALLATION

**IMPORTANT NOTE:** For standard installations, a minimum 24" (610) of usable cabinet depth is required, or the back panel of the cabinet may need to be removed for proper installation. The electrical box must be flush with the back panel of the cabinet.

For standard installations, the E Series built-in oven is installed by inserting into cabinetry from the front. The oven has a face trim on all four sides and will overlap stiles and rails. The trim overlaps  $\frac{1}{8}$ " (3) on the bottom,  $\frac{5}{8}$ " (8) on the top and  $\frac{3}{4}$ " (19) on each side.

### FLUSH INSET INSTALLATION

**IMPORTANT NOTE:** For flush inset installations, a minimum 25" (635) of usable cabinet depth is required, or the back panel of the cabinet may need to be removed for proper installation. The electrical box must be flush with the back panel of the cabinet.

The flush inset installation requires the built-in oven to be recessed into the cabinet. A minimum 33" (838) wide and 25" (635) deep cabinet is needed if you want the front of the oven to be flush with surrounding cabinetry.

**IMPORTANT NOTE:** For flush inset installations, the inside edges of the rough opening must be finished, as they will be exposed when the oven doors are open. These edges should be stained instead of having a laminated surface, to avoid damage from high temperatures during self-clean.



E SERIES BUILT-IN DOUBLE OVENS

STANDARD INSTALLATION

Overall Oven Width	29 <sup>7</sup> / <sub>8</sub> " (759)
Overall Oven Height	50 <sup>3</sup> / <sub>8</sub> " (1292)
Overall Oven Depth (behind frame)	23 <sup>3</sup> / <sub>4</sub> " (603)
Open Door Clearance	22" (559)
Recommended Cabinet Width	33" (838)

Minimum Cabinet Width	30" (762)
Minimum Cabinet (Opening) Depth	24" (610)
Opening Width	28 <sup>1</sup> / <sub>2</sub> " (724)
Opening Height	49 <sup>5</sup> / <sub>8</sub> " (1260)
Minimum Base Support	400 lbs (181 kg)

STANDARD INSTALLATION – MODELS DO30-2F/S AND DO30-2U/S

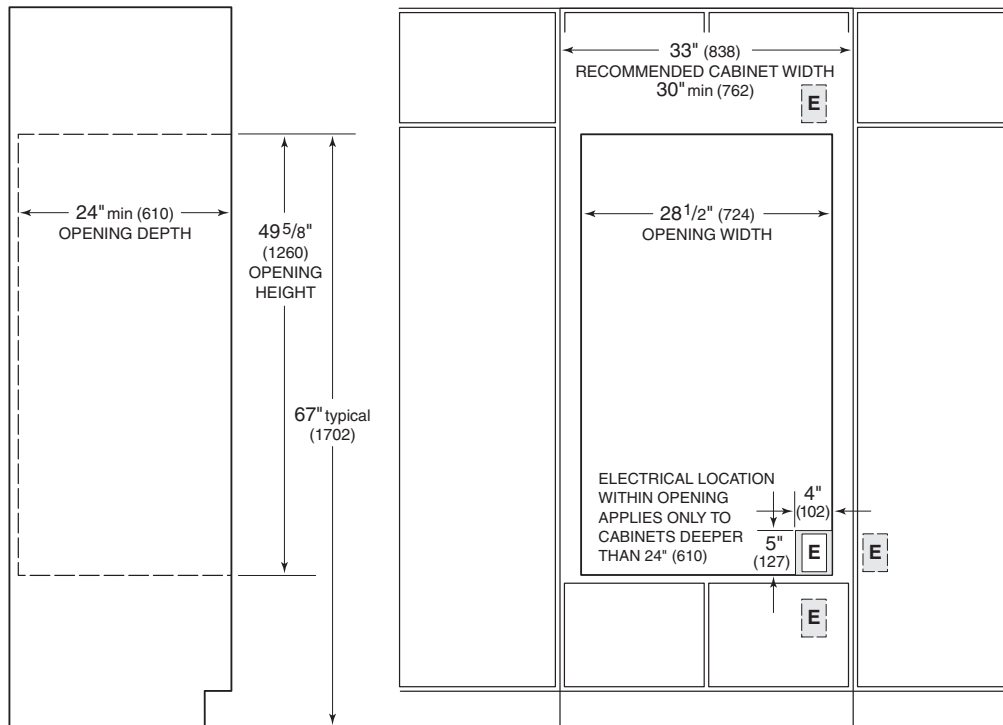



E SERIES BUILT-IN DOUBLE OVENS

FLUSH INSET INSTALLATION

Overall Oven Width	29 <sup>7</sup> / <sub>8</sub> " (759)
Overall Oven Height	50 <sup>3</sup> / <sub>8</sub> " (1292)
Overall Oven Depth (behind frame)	23 <sup>3</sup> / <sub>4</sub> " (603)
Open Door Clearance	22" (559)
Minimum Base Support	400 lbs (181 kg)

Minimum Cabinet Width	33" (838)
Minimum Flush Inset Depth	25" (635)
Opening Width	28 <sup>1</sup> / <sub>2</sub> " (724)
Minimum Flush Inset Width	30 <sup>3</sup> / <sub>8</sub> " (772)
Opening Height	49 <sup>5</sup> / <sub>8</sub> " (1260)
Minimum Flush Inset Height	50 <sup>15</sup> / <sub>16</sub> " (1294)

IMPORTANT NOTE

For flush inset installations, the inside edges of the rough opening must be finished, as they will be exposed when the oven doors are open.

FLUSH INSET INSTALLATION – MODELS DO30-2F/S AND DO30-2U/S

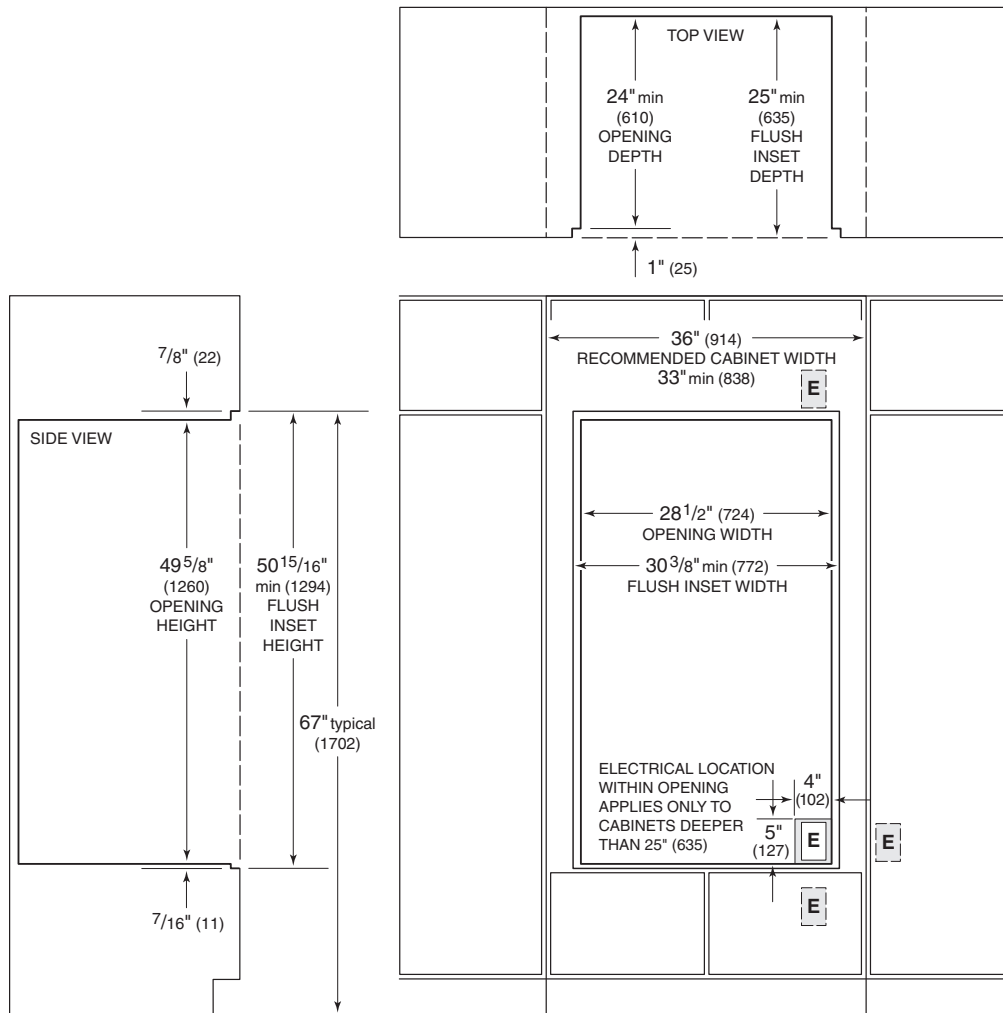

Dimensions in parentheses are in millimeters unless otherwise specified.



STANDARD INSTALLATION OPTIONS

E SERIES BUILT-IN SINGLE OVEN

The Wolf E Series single oven may be installed in combination with a Wolf convection or non-convection microwave oven with 30" (762) E Series trim kit, and a Wolf warming drawer with E Series stainless steel drawer front or integrated drawer front. Refer to the illustration below, and pages 4–7 for installation specifications for E Series single ovens.

Keep in mind that the size of the custom panel for the warming drawer with integrated drawer front will vary according to the specific installation. Refer to the installation instructions provided with the microwave trim kit and warming drawer front for detailed specifications. Dimensions will vary according to the specific installation.

STANDARD INSTALLATION – MODELS SO30-2F/S AND SO30-2U/S

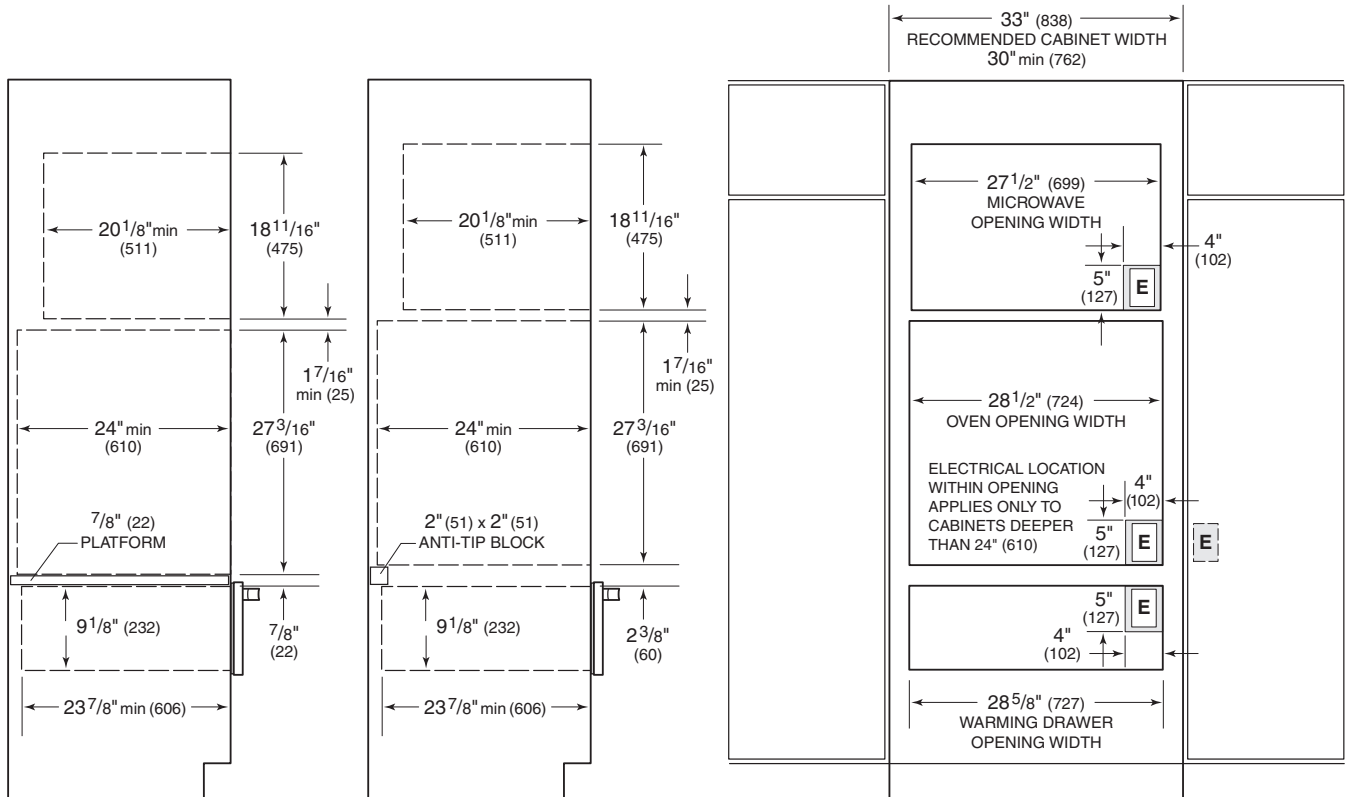

PLATFORM APPLICATION

ANTI-TIP BLOCK APPLICATION

NOTE: Unless you are using cabinets deeper than 24" (610), it is recommended that the electrical supply for the oven be placed in an adjacent cabinet within reach of the conduit.

Single oven installed with convection microwave with 30" (762) E Series trim and warming drawer with E Series stainless steel drawer front.



STANDARD INSTALLATION OPTIONS

E SERIES BUILT-IN DOUBLE OVEN

The Wolf E Series double oven may be installed in combination with a Wolf warming drawer with E Series stainless steel drawer front or integrated drawer front. Refer to the illustration below, and pages 8–11 for installation specifications for E Series double ovens.

Keep in mind that the size of the custom panel for the warming drawer with integrated drawer front will vary according to the specific installation. Refer to the installation instructions provided with the warming drawer front for detailed specifications. Dimensions will vary according to the specific installation.

STANDARD INSTALLATION – MODELS DO30-2F/S AND DO30-2U/S

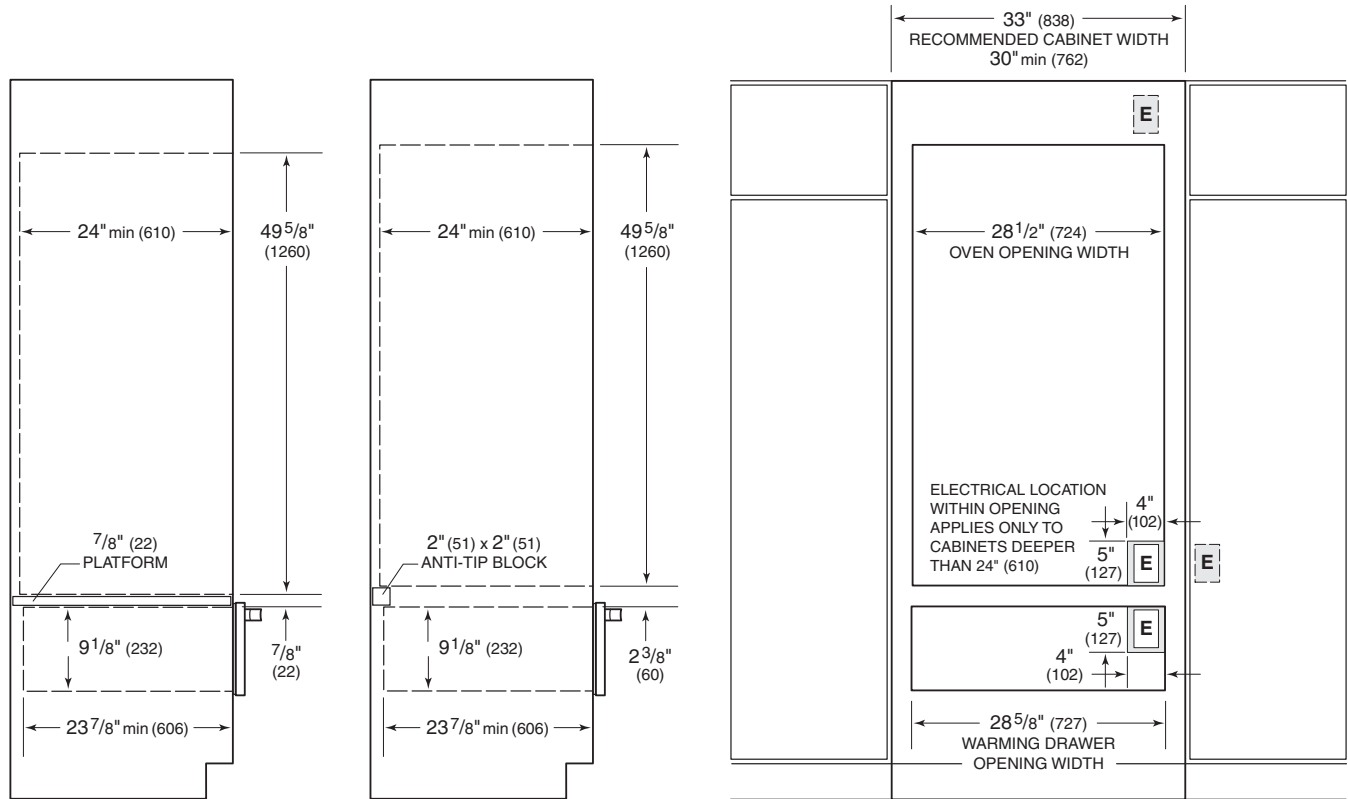

PLATFORM APPLICATION

ANTI-TIP BLOCK APPLICATION

NOTE: Unless you are using cabinets deeper than 24" (610), it is recommended that the electrical supply for the oven be placed in an adjacent cabinet within reach of the conduit.

Double oven installed above warming drawer with E Series stainless steel drawer front.

Dimensions in parentheses are in millimeters unless otherwise specified.



**ELECTRICAL REQUIREMENTS**

**⚠ WARNING**  
**Verify that power is disconnected from the electrical box before proceeding.**

**IMPORTANT NOTE**

**You must follow all National Electrical Code regulations. In addition, be aware of local codes and ordinances when installing your service.**

**E SERIES SINGLE OVENS**

- **Required power supply:**  
240/208 V AC / 60 Hz / 30 amp service
- **Maximum connected load:**  
5.1 kW at 240 V AC; 3.8 kW at 208 V AC with minimum 30 amp service
- **Total amps:** 21 amps  
**Minimum supply wire size:** L1, L2 and ground–10 AWG

**E SERIES DOUBLE OVENS**

- **Required power supply:**  
240/208 V AC / 60 Hz / 50 amp service
- **Maximum connected load:**  
8.9 kW at 240 V AC; 6.7 kW at 208 V AC with minimum 50 amp service
- **Total amps:** 37 amps  
**Minimum supply wire size:** L1, L2 and ground–10 AWG

The built-in oven is provided with a conduit consisting of two insulated hot lead conductors (copper) and an insulated ground conductor (copper). If necessary, refer to the wiring diagram showing the connections for each lead to the terminal box on the unit.

**For UL installations:** Attach the conductors to the residence wiring in accordance with National Electrical Codes and all state, municipal and local codes.

**For CSA installations:** Attach the conductors to the electrical box provided. Then connect the residence wiring to the electrical box in accordance with all national, provincial and local codes.

**⚠ WARNING**

**The complete appliance must be properly grounded at all times when electrical power is applied.**

**Grounding through the neutral conductor is prohibited for new branch-circuit installations (1996 NEC); mobile homes; and recreational vehicles, or in an area where local codes prohibit grounding through the neutral conductor.**

**If aluminum house supply wiring is utilized, splice the appliance copper wire to the aluminum house wiring using special connectors design and agency certified for joining copper and aluminum. Follow the connector manufacturer's recommended procedure carefully. NOTE: Improper connection can result in a fire hazard.**

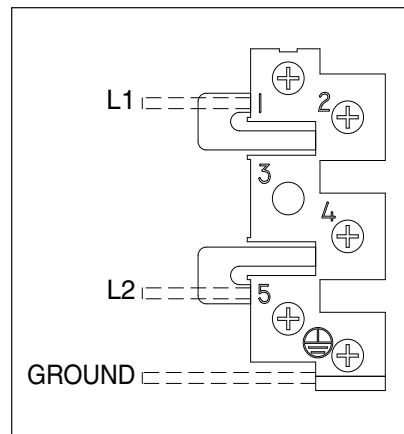

**Wiring diagram**



**ELECTRICAL REQUIREMENTS**

With the oven positioned directly in front of the cabinet opening, feed the conduit through the opening in the cabinet platform (where applicable). Then, depending upon local codes, utilize one of the following techniques to connect the appliance to the electrical power supply.

**To connect to a four-wire electrical system, follow these steps:**

- Connect one hot lead to the black (L1) power supply wire in the electrical box.
- Connect the other hot lead to the red (L2) power supply wire in the electrical box.
- Connect the ground wire to the green/ground house grounding wire in the electrical box.

**⚠ CAUTION**  
 Leave the white neutral floating (not connected to anything, but sealed off with a wire cap).

**To connect to a three-wire electrical system, follow these steps:**

- Connect one hot lead to the black (L1) power supply wire in the electrical box.
- Connect the other hot lead to the red (L2) power supply wire in the electrical box.
- Connect the ground wire to the green/ground house grounding wire in the electrical box.

Dimensions in parentheses are in millimeters unless otherwise specified.

**INSTALLING THE OVEN**

**UNPACK THE OVEN**

**⚠ CAUTION**  
 Oven is not mounted to the shipping base. Do not remove banding until the oven is at the point of installation.

Cut the plastic straps and remove the two V-boards. Remove the four top foam corners and the corner posts. Remove the carton sleeve by lifting the sleeve up and over the appliance.

Remove all oven racks, oven rack guides and broiler pan from inside the oven cavity. For the double oven, be sure to do this for both the upper and lower ovens.

Remove the four bottom corners. Use caution as the oven is not mounted to the shipping base. Keep the bottom foam in place when moving or carting the oven. The bottom foam also protects the factory-installed trim.

**⚠ CAUTION**  
 Do not remove the bottom foam until oven has been positioned next to the installation opening.

**IMPORTANT NOTE:** Before moving the oven, protect any finished flooring with appropriate materials to avoid damage to the floor.

Remove and discard all packing materials, including cardboard and tape on the outside of the oven and inside the oven cavity.

**⚠ CAUTION**  
 Do not lift the unit by the oven door handle(s). This will damage the oven door and hinges.

**INSTALLING THE OVEN****OVEN DOOR REMOVAL**

To reduce the weight of the oven and ease installation, removal of the oven door(s) is an option.

**To Remove Oven Door:**

- Open oven door all the way.
- Flip up the hinge latch on each side.
- Close the oven door as far as it will shut.
- While holding the oven door on each side with both hands, lift the oven door up. Continue to push the oven door closed and pull it away from the oven frame.

**To Reinstall Oven Door:**

- Insert both hanger arms into the oven frame openings.
- Open the oven door. You should hear a "click" as the door is set into place.
- Move the hinge levers back to the locked position. Ensure that the door is free to open and close. If not, repeat the removal and reinstallation procedures.

**POSITION THE OVEN****⚠ CAUTION**

**The oven is very heavy—use caution when lifting. It is recommended that two people lift and position the oven into the opening. Wear gloves to protect hands from any sharp edges.**

Holding the oven by the upper edge and bottom side of the oven chassis, carefully lift the oven up to the cabinet opening.

Resting the oven on the cabinet base platform, slide the oven into the opening until it is approximately 6" (152) from full insertion. If applicable, ensure that the installer supplied cable slides through the opening in the cabinet platform as the oven is slid into place.

**IMPORTANT NOTE:** The installer supplied cable must be placed in the recessed area located along the right rear vertical edge of the oven. Make sure that the cable is not trapped between the oven and the inner cabinet wall.

**⚠ CAUTION**

**Do not block the oven air exhaust located at the bottom of the oven. Blocking the exhaust may cause cabinet damage and poor baking performance.**





**INSTALLING THE OVEN**

**MOUNT OVEN TO CABINETRY**

Once the oven is fully inserted into the cabinet opening, locate the mounting holes on the oven side trim. There will be four mounting holes for a single oven and six for a double oven. Refer to the illustration below. Use a 1/16" drill bit to drill pilot holes into the cabinet. Use the provided wood screws to secure the oven to the cabinet through the oven mounting holes.

**⚠ WARNING**

Failure to install the mounting screws may cause the oven to move or tip forward during use. This may result in damage to the oven or personal injury.

**OVEN OPERATION**

**IMPORTANT NOTE:** Prior to operating the oven, be sure to read the entire Wolf E Series Built-In Ovens Use & Care Information included with the oven for important safety, service and warranty information.

Unpack the box containing the oven components found in each oven cavity. Install the oven rack guides onto the shoulder screws located on the interior side walls of the oven. Slide the oven racks onto the support racks within the oven. There are three racks per oven. Place the broiler pan and grid on a rack within the oven, if desired.

Turn on the power supply to the oven. Set the time of day by pressing the **CLOCK** touch pad, input the desired time by using the number pads, then touch **ENTER**.

Select any of the ten cooking modes on the control panel. Verify that the oven is coming up to temperature. For the double oven, be sure to verify operation of both ovens.

**IMPORTANT NOTE:** A small amount of smoke and odor may be noticed during the initial break-in period. Refer to the Use & Care Information for additional information.

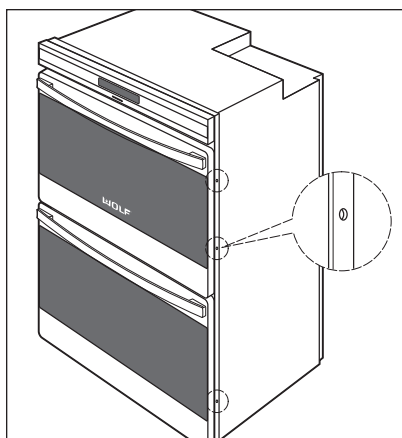

Location of mounting holes



### CONTACT INFORMATION

**Wolf Customer Service:**  
**800-332-9513**

**Website:**  
**wolfappliance.com**

### TROUBLESHOOTING

**IMPORTANT NOTE:** If the built-in oven does not operate properly, follow these troubleshooting steps:

- Verify that power is being supplied to the oven.
- Check the electrical connections to ensure that the installation has been completed correctly.
- Follow troubleshooting procedures as described in the Wolf E Series Built-In Ovens Use & Care Information.
- If the oven still does not work, contact a Wolf authorized service center. Do not attempt to repair the oven yourself. Wolf is not responsible for service required to correct a faulty installation.

### IF YOU NEED SERVICE

- If service is necessary, maintain the quality built into your built-in oven by calling a Wolf authorized service center.
- To obtain the name and number of a Wolf authorized service center, check the Constant Care section of our website, **wolfappliance.com** or call Wolf Customer Service at **800-332-9513**.
- When calling for service, you will need the built-in oven model and serial numbers. Both numbers are listed on the product rating plate, located on the right side of the oven trim, directly above the door. Open the oven door to view the rating plate. Refer to the illustration on page 3 for location of the rating plate.

### WIRING DIAGRAM

The wiring diagram covering the control circuit is located on the top of the oven in a sealed plastic bag.



**The information and images in this book are the copyright property of Wolf Appliance, Inc., an affiliate of Sub-Zero, Inc. Neither this book nor any information or images contained herein may be copied or used in whole or in part without the express written permission of Wolf Appliance, Inc., an affiliate of Sub-Zero, Inc.**

**©Wolf Appliance, Inc. all rights reserved.**



WOLF APPLIANCE, INC. P.O. BOX 44848 MADISON, WI 53744 800-332-9513 WOLFAPPLIANCE.COM

**WOLF**<sup>®</sup>

811576

7/2007



811576