

# Surface Operation Controls

**Single Front or Rear Element**  
Push in and turn the control knob counterclockwise to the desired setting. The element will cycle on and off to maintain the desired heat setting. When finished, turn all controls to "OFF."

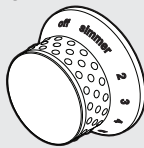

**Front and Bridge Element**  
Push in and turn the right rear control knob clockwise to the desired setting. The rear element and the bridge element will cycle on and off to maintain the desired heat setting. When finished, turn all controls "OFF."

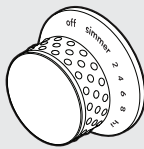

**Hot Surface Indicator Lights**  
The range has four hot surface indicator lights. They are located in the front center of the glass rangetop. The hot surface indicator light will glow red when the corresponding element is heated. The light will remain on after turning off the control knob until the corresponding element has cooled to a safe temperature.

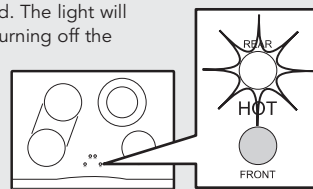

## Oven Functions

**Preheat**  
For best results, it is extremely important that you preheat your oven to the desired cooking temperature before placing food items in the oven to begin cooking. In many cooking modes, partial power from the broiler is used to bring the oven to the preheat temperature. Therefore, placing food items in the oven during the preheat mode is not recommended. The Viking Rapid Ready™ Preheat System is engineered so that the oven is brought to the desired set temperature in a manner which will provide the optimum cooking environment based on the selected cooking mode in the shortest possible time.

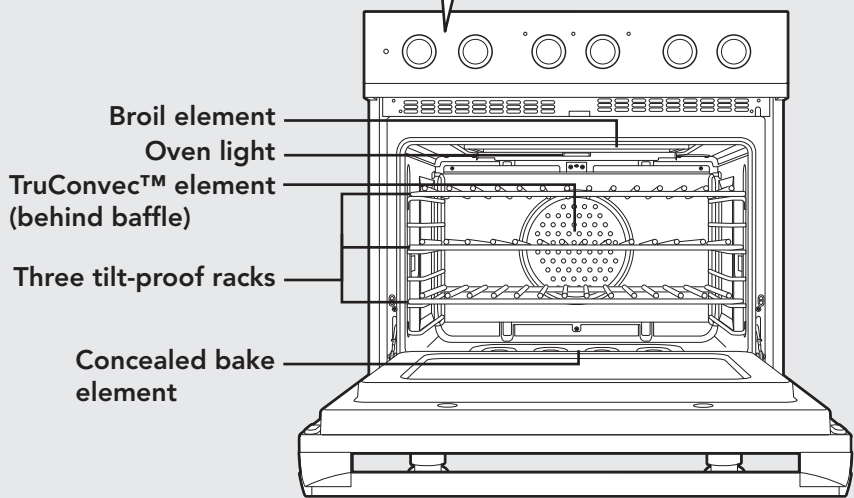
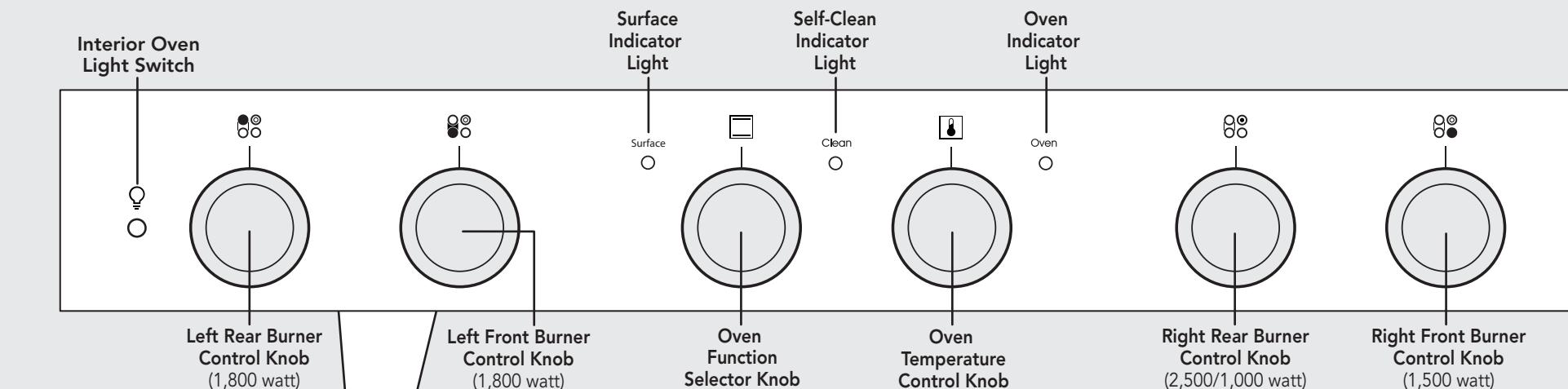
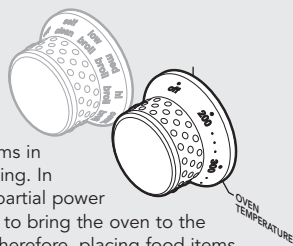

### Surface Heat Settings\*

Heat Setting	Use
Simmer	Melting small quantities Steaming rice Simmering sauces
Low (setting 2)	Melting large quantities
Med Low (settings 3-4)	Low-temperature frying (eggs, etc.) Simmering large quantities Heating milk, cream sauces, gravies, and puddings
Med (setting 5)	Sautéing and browning, braising, and pan-frying Maintaining slow boil on large quantities
Med High (settings 7-8)	High-temperature frying Pan broiling Maintaining fast boil on large quantities
High	Boiling water quickly Deep-fat frying in large cookware

**\*Note:** The above information is given as a guide only. You may need to vary the heat settings to suit your personal requirements.

### Oven Functions

- **BAKE (Two-Element Bake)**  
Use this setting for baking, roasting, and casseroles.
- **CONV BAKE (Convection Bake)**  
Use this setting to bake and roast foods at the same time with minimal taste transfer.
- **TRU CONV (TruConvect™)**  
Use this bake setting for multi-rack baking for breads, cakes, cookies (up to 6 racks of cookies at once).
- **CONV ROAST (Convection Roast)**  
Use this setting for roasting whole turkeys, whole chickens, hams, etc.
- **CONV BROIL (Convection Broil)**  
Use this setting to broil thick cuts of meat.
- **HI BROIL**  
Use this setting for broiling dark meats at 1" thickness or less where rare or medium doneness is desired.
- **MED BROIL**  
Use this setting for broiling white meats such as chicken or meats greater than 1" thick that would be over-browned in high broil.
- **LOW BROIL**  
Use this setting for delicate broiling such as meringue.
- **SELF CLEAN**  
Use this function to clean oven.
- **Convection Dehydration (TRU CONV)**  
Use this function to dehydrate fruits and vegetables.
- **Convection Defrost (TRU CONV)**  
Use this function to defrost foods.

# Oven Settings

**BAKE (Two-Element Bake)**  
Full power heat is radiated from the bake element in the bottom of the oven cavity and supplemental heat is radiated from the broil element. This function is recommended for single rack baking. Many cookbooks contain recipes to be cooked in the conventional manner. Conventional baking/roasting is particularly suitable for dishes that require a high temperature. Use this setting for baking, roasting, and casseroles.

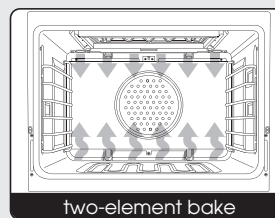

**CONV BAKE (Convection Bake)**  
The bottom element operates at full power, and the top broil element operates at supplemental power. The heated air is circulated by the motorized fan in the rear of the oven providing a more even heat distribution. This even circulation of air equalizes the temperature throughout the oven cavity and eliminates the hot and cold spots found in conventional ovens. A major benefit of convection baking is the ability to prepare food in quantity using multiple racks—a feature not possible in a standard oven.

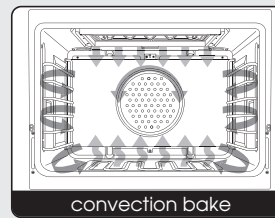

When roasting using this setting, cool air is quickly replaced, searing meats on the outside and retaining more juices and natural flavor on the inside with less shrinkage. With this heating method, foods can be baked and roasted at the same time with minimal taste transfer, even when different dishes are involved, such as cakes, fish or meat. The hot air system is especially economical when thawing frozen food. Use this setting for baking and roasting.

**TRU CONV (TruConvect™)**  
The rear element only operates at full power. There is no direct heat from the bottom or top elements. The motorized fan in the rear of the oven circulates air in the oven cavity for even heating. Use this setting for foods that require gentle cooking such as pastries, souffles, yeast

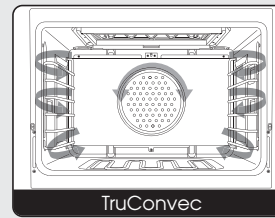

breads, quick breads, and cakes. Breads, cookies, and other baked goods come out evenly textured with golden crusts. No special bakeware is required. Use this function for single rack baking, multiple rack baking, roasting, and preparation of complete meals. This setting is also recommended when baking large quantities of baked goods at one time.

**CONV ROAST (Convection Roast)**  
The convection element runs in conjunction with the inner and outer broil elements. The reversible convection fan runs at a higher speed in each direction. This transfer of heat (mainly from the convection element) seals moisture inside of large roasts. A time savings is gained over existing, single fan convection roast modes. Use this setting for whole turkeys, whole chickens, hams, etc.

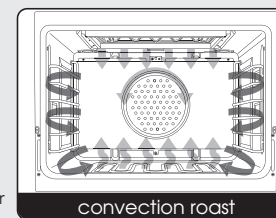

**CONV BROIL (Convection Broil)**  
The top element operates at full power. This function is exactly the same as regular broiling with the additional benefit of air circulation by the motorized fan in the rear of the oven. Smoke is reduced since the airflow also reduces peak temperatures on the food. Use this setting for broiling thick cuts of meats.

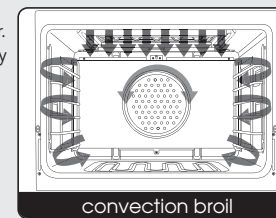

**HI BROIL**  
Heat radiates from both broil elements, located in the top of the oven cavity, at full power. The distance between the foods and the broil elements determines broiling speed. For fast broiling, food may be as close as 2 inches (5 cm) to the broil element or on the top rack. Fast broiling is best for meats where rare to medium doneness is desired. Use this setting for broiling small and average cuts of meat.

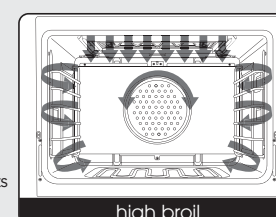

**MED BROIL**  
Inner and outer broil elements pulse on and off to produce less heat for slow broiling. Allow about 4 inches (10 cm) between the top surface of the food and the broil element. Slow broiling is best for chicken and ham in order to broil food without over-browning it. Use this setting for broiling small and average cuts of meat.

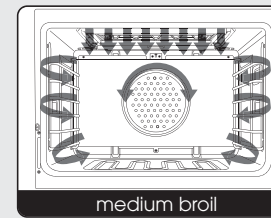

**LOW BROIL**  
This mode uses only a fraction of the available power to the inner broil element for delicate top-browning. The inner broil element is on for only part of the time. Use this setting to gently brown meringue on racks 3 or 4 in 3-4 minutes.

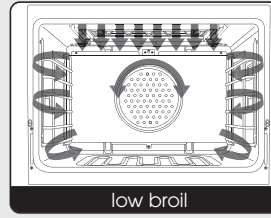

**Convection Dehydration**  
This oven is designed not only to cook, but also to dehydrate fruits and vegetables.  
1. Prepare the food as recommended.  
2. Arrange the food on drying racks (not included with the oven; contact a local store handling speciality cooking utensils).  
3. Set the appropriate low temperature and turn the selector to "TRU CONV".

**Convection Defrost**  
1. Place the frozen food on a baking sheet.  
2. Set the temperature control to "OFF".  
3. Turn the selector to "TRU CONV".

**Self-Clean Cycle**  
This range features a self-cleaning cycle. During this cycle, the oven reaches elevated temperatures in order to burn off soil and deposits. A powder ash residue is left in the bottom of the oven after completion of the self-clean cycle. See Use and Care Manual for self-clean cycle instructions.

# Warnings

Warning and Important Safety Instructions appearing in this manual are not meant to cover all possible conditions and situations that may occur. Common sense, caution, and care must be exercised when installing, maintaining, or operating the appliance.

ALWAYS contact the manufacturer about problems or conditions you do not understand.

### Recognize Safety Symbols, Words, Labels

**DANGER**  
Hazards or unsafe practices which WILL result in severe personal injury or death

**WARNING**  
Hazards or unsafe practices which COULD result in death, severe personal injury or property damage

**CAUTION**  
Hazards or unsafe practices which COULD result in minor personal injury.  
All safety messages will identify the hazard, tell you how to reduce the chance of injury, and tell you what can happen if the instructions are not followed.

Read and follow all instructions before using this appliance to prevent the potential risk of fire, electric shock, personal injury or damage to the appliance as a result of improper usage of the appliance. Use appliance only for its intended purpose as described in this manual.

To ensure proper and safe operation: Appliance must be properly installed and grounded by a qualified technician. DO NOT attempt to adjust, repair, service, or replace any part of your appliance unless it is specifically recommended in this manual. All other servicing should be referred to a qualified servicer.

**CAUTION**  
To prevent possible damage to cabinets and cabinet finishes, use only materials and finishes that will not discolor or delaminate and will withstand temperatures up to 194° F (90° C). Heat and moisture resistant adhesive must be used if the product is to be installed in laminated cabinetry. Check with your builder or cabinet supplier to make sure that the materials meet these requirements.

### Important Safety Notice and Warning

The California Safe Drinking Water and Toxic Enforcement Act of 1986 (Proposition 65) requires the Governor of California to publish a list of substances known to the State of California to cause cancer or reproductive harm, and requires businesses to warn customers of potential exposures to such substances. Users of this appliance are hereby warned that when the oven is engaged in the self-clean cycle, there may be some low-level exposure to some of the listed substances, including carbon monoxide. Exposure to these substances can be minimized by properly venting the oven to the outdoors by opening the windows and/or door in the room where the appliance is located during the self-clean cycle.

### Important notice regarding pet birds:

NEVER keep pet birds in the kitchen or in rooms where the fumes from the kitchen could reach. Birds have a very sensitive respiratory system. Fumes released during an oven self-cleaning cycle may be harmful or fatal to birds. Fumes released due to overheated cooking oil, fat, margarine and overheated non-stick cookware may be equally harmful.

### About Your Appliance

- Avoid touching oven vent area while oven is on and for several minutes after oven is turned off. When the oven is in use, the vent and surrounding area become hot enough to cause burns. After oven is turned off, DO NOT touch the oven vent or surrounding areas until they have had sufficient time to cool.
- Other potentially hot surfaces include range top, areas facing the range top, oven vent, surfaces near the vent opening, oven door, areas around the oven door and oven window.
- The misuse of oven doors (e.g. stepping, sitting, or leaning on them) can result in potential hazards and/or injuries.

# Warnings (cont.)

### Heating Elements and Glass Ceramic Cooking Surfaces

- Surface areas on or adjacent to the unit may be hot enough to cause burns.
- NEVER touch oven heating elements, areas near elements, or interior surfaces of oven.
- Heating elements may be hot even though they are dark in color. Areas near elements and interior surfaces of an oven may become hot enough to cause burns.
- During and after use, DO NOT touch or let clothing or other flammable material contact surface of unit or areas near unit, heating elements, or interior surfaces of oven until they have had sufficient time to cool.
- DO NOT COOK ON BROKEN COOKING SURFACE – If cooking surface should break, cleaning solutions and spills may penetrate the broken cooking surface and create a risk of electric shock. Contact a qualified technician immediately.

**CAUTION**  
DO NOT touch the exterior portions of the oven after self-cleaning cycle has begun, since some parts become extremely hot to the touch!

During the first few times the self-cleaning feature is used, there may be some odor and smoking from the "curing" of the binder in the high-density insulation used in the oven. When the insulation is thoroughly cured, this odor will disappear. During subsequent self-cleaning cycles, you may sense an odor characteristic of high temperatures.

**KEEP THE KITCHEN WELL-VENTED DURING THE SELF-CLEAN CYCLE.**

**WARNING**  
This range features a self-cleaning cycle. During this cycle, the oven reaches elevated temperatures in order to burn off soil and deposits. A powder ash residue is left in the bottom of the oven after completion of the self-clean cycle.

**Note: DO NOT use commercial oven cleaners inside the oven. Use of these cleaners can produce hazardous fumes or can damage the porcelain finishes. DO NOT line the oven with aluminum foil or other materials. These items can melt or burn during a self-clean cycle, causing permanent damage to the oven.**

**CAUTION**  
**BURN HAZARD**  
When self-cleaning, surfaces may get hotter than usual. Therefore, children should be kept away.

**CAUTION**  
You must carefully check the food during the dehydration process to ensure that it does not catch fire.

**CAUTION**  
DO NOT store items of interest to children over the unit. Children climbing to reach items could be seriously injured.

**WARNING**  
**TIPPING HAZARD**  
To reduce the risk of the appliance tipping, it must be secured by a properly installed anti-tip bracket(s). To make sure the bracket has been installed properly, look behind the range with a flashlight to verify proper installation engaged in the rear top left corner of the range.

- THIS RANGE CAN TIP
- INJURIES TO PERSONS CAN RESULT
- INSTALL ANTI-TIP DEVICE PACKED WITH RANGE
- SEE INSTALLATION INSTRUCTIONS

**WARNING**  
To avoid risk of property damage, personal injury or death; follow information in this manual exactly to prevent a fire or explosion. DO NOT store or use gasoline or other flammable vapors and liquids in the vicinity of this or any appliance.

**CAUTION**  
DO NOT heat empty cookware or let cookware boil dry. The cookware can absorb an excessive amount of heat very quickly, resulting in possible damage to the cookware and ceramic glass.

# Warnings (cont.)

**WARNING**  
**BURN HAZARD**  
The oven door, especially the glass, can get hot. **Danger of burning: DO NOT touch the glass!**

**WARNING**  
NEVER use appliance as a space heater to heat or warm a room to prevent potential hazard to the user and damage to the appliance. Also, DO NOT use the range top or oven as a storage area for food or cooking utensils.

**WARNING**  
**ELECTRICAL SHOCK HAZARD**  
Disconnect the electric power at the main fuse or circuit breaker before replacing bulb.

**WARNING**  
**ELECTRICAL SHOCK HAZARD**  
DO NOT touch a hot oven light bulb with a damp cloth as the bulb could break. Should the bulb break, disconnect power to the appliance before removing bulb to avoid electrical shock.

**CAUTION**  
To avoid sickness and food waste, DO NOT allow defrosted food to remain in the oven for more than two hours.

**NOTICE**  
DO NOT turn the Temperature Control on during defrosting. Turning the convection fan on will accelerate the natural defrosting of the food without the heat.

**WARNING**  
**BURN OR ELECTRICAL SHOCK HAZARD**  
Make sure all controls are OFF and oven is COOL before cleaning. Failure to do so can result in burns or electrical shock.

**WARNING**  
DO NOT use commercial oven cleaners inside the oven. Use of these cleaners can produce hazardous fumes or can damage the porcelain finishes.

**NOTICE**  
Avoid any damage to oven vents. The vents need to be unobstructed and open to provide proper airflow for optimal oven performance.

**NOTICE**  
The Cooling Fan should be operating when the unit is in operation. If you notice the cooling fan is not operating or you observe unusual or excessive noise coming from the cooling fan, contact a Viking Authorized Service Center before continuing operation. Failure to do so can result in damage to the oven or surrounding cabinets.

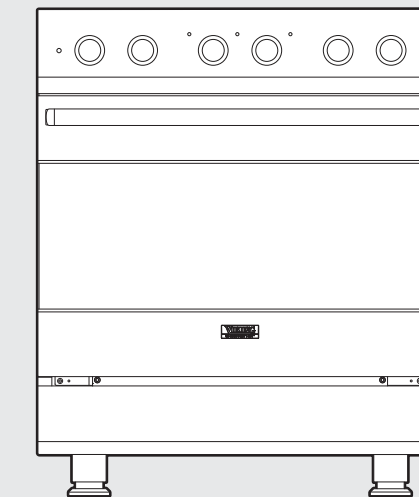

# Viking Quick Reference Guide

