



# commercial laundry

GE® commercial washer and dryer 2007 product specifications  
[gecommerciallaundry.com](http://gecommerciallaundry.com)



## Feature gallery

### Heavy-duty commercial washer and dryer



#### PermaTuf® II basket

Resists peeling, chipping, rusting or flaking for long-term durability.



#### ArmorGuard™ protection

Provides a rust-resistant, durable finish to the washer top and lid.

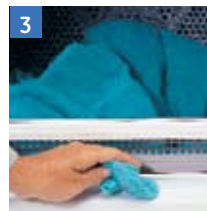

#### Upfront lint filter

Easy to see and clean and is permanently installed to protect from vandalism.

### Frontload commercial washer and dryer



#### Automatic water fill

Eliminates guesswork and water waste. Automatically adjusts to the load type. Water fill level remains below the door.



#### Automatic dispenser

Automatically dispenses detergent, bleach and fabric softener at just the right time in the wash cycle. **Use of high-efficiency liquid or powder detergents is strongly recommended.**

## Smart Card commercial washer and dryer



ESD Smart Card reader



Auto balance suspension system

Keeps the washer balanced even if the load is unbalanced.



Extra-wide dryer opening

Provides easy access to the 7.0 cu. ft. of total dryer capacity.

## Non-coin commercial washer and dryer

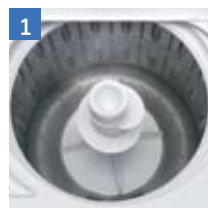

Stainless steel basket

Durable, won't chip or peel and resists rust.

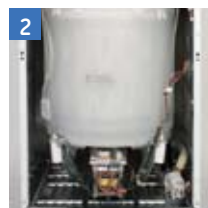

Auto balance suspension system

Handles the heaviest loads without banging, walking or shutting itself off.



Upfront lint filter

Easy to see and clean.

Not all features available on all models.

## Smart Card commercial washer and dryer



### WNCK2050H

#### GE® ESD Smart Card commercial washer

- 3.2 cu. ft. capacity
- Variable speed drive
- 5 wash cycles
- 3 wash/spin speed combinations
- 3 wash/rinse temperatures
- 4 water levels (adjustable)
- Digital cycle countdown
- Color Cottons
- Bright Colors
- Permanent Press
- White Cottons
- Delicates
- Quiet Package
- Lid instructions
- LED indicators
- ESD Smart Card reader
- Alphanumeric display
- Control card
- **Smart Cards and value transfer machines sold separately**



### DNCK440EG/GG

#### GE ESD Smart Card commercial dryer

- 7.0 cu. ft. capacity
- 4 dry cycles
- 4 heat selections
- Digital cycle countdown
- Quiet-By-Design™
- Anti-theft lint filter
- Reverse-a-Door
- LED indicators
- ESD Smart Card reader
- Alphanumeric display
- Control card
- **Smart Cards and value transfer machines sold separately**



3-Year limited parts warranty; 5-Year limited parts warranty on outer tub, inner basket, dryer drum and cabinet rust-through.

See written warranty for details.

## Non-coin commercial washer and dryer



### WNRD2050G

#### GE non-coin commercial washer

- 3.5 cu. ft. capacity
- Stainless steel basket
- Variable speed drive
- 5 wash cycles
- Exclusive auto balance suspension system
- 4 water levels
- 3 wash/spin speed combinations
- 3 wash/rinse temperatures
- Spin only
- Digital cycle countdown
- LED indicators for fill, wash, rinse and final spin
- Bleach dispenser
- Fabric softener dispenser
- Deluxe quiet



Available in 4Q 07



### DNCD450EG/GG

#### GE non-coin commercial dryer

- 7.0 cu. ft. capacity
- 5 dry cycles
- 4 temperatures
- Air dry
- Digital cycle countdown
- Deluxe quiet
- LED indicators for door open, drying, cool down, clean lint filter
- Easy-clean lint filter
- Reverse-a-Door



## Vision-impaired kit



The GE commercial washer and dryer offers panel overlays for the washer and dryer and Braille instructions for placement on control panels. The kit also includes an audio cassette. The washer and dryer models (WNRD205G and DNCD450EG/GG) shown to the left demonstrate the overlays.

### How to order a vision-impaired kit:

To purchase Braille Kit, Pub. No. 14-D242, call 800-626-2202, or go to [www.geappliances.com](http://www.geappliances.com), select Washers and Dryers, then Parts and Accessories.

1-year limited parts and labor warranty.  
See written warranty for details.

## Heavy-duty commercial washers



### WMCD2050H\*

#### GE® heavy-duty commercial washer

- Includes installed Greenwald VERT 8 coin kit
- 3.2 cu. ft. capacity
- Variable speed drive
- ExtrAction™ wash basket
- 5 wash cycles
- 3 water levels (adjustable)
- 3 wash/rinse temperatures
- 2 wash/spin speeds
- Digital cycle countdown
- LED status lights
- GentlePower™ agitator
- Front serviceable



### WCRD2050H

#### GE heavy-duty commercial washer

- 3.5 cu. ft. capacity
- Variable speed drive
- Stainless steel basket
- 5 wash cycles
- 3 water levels (adjustable)
- 3 wash/rinse temperatures
- 2 wash/spin speed combinations
- 24-minute wash cycle
- Digital cycle countdown
- LED status lights
- Front serviceable

**Coin mechanism sold separately.**

### WCCD2050H

Similar to WCRD2050H except 3.2 cu. ft. capacity ExtrAction™ basket.



### WCCB1030H

#### GE heavy-duty commercial washer

- 3.2 cu. ft. capacity
- ExtrAction™ basket
- Variable speed drive
- 3 wash cycles
- 3 water levels (adjustable)
- 3 wash/rinse temperatures
- 1 wash/spin speed combination
- Large LED status lights
- 24-minute wash cycle
- Front serviceable

**Coin mechanism sold separately.**

*\*Includes 90-day limited parts and labor warranty (except coin system).  
3-year limited parts warranty; 5-year limited parts warranty on outer tub,  
inner basket, dryer drum and cabinet rust-through.*

*See written warranty for details.*



## Heavy-duty commercial dryers



### DMCD330EH/GH\* (Electric/Gas)

#### GE heavy-duty commercial dryer

- Includes installed Greenwald VERT 8 coin kit
- 7.0 cu. ft. capacity
- 3 cycles
- 3 heat selections
- LED status lights



### DCCD330EG/GG (Electric/Gas)

#### GE heavy-duty commercial dryer

- 7.0 cu. ft. capacity
- Digital cycle countdown
- LED status lights
- 3 cycles
- 3 heat selections

**Coin mechanism sold separately.**

### DCCB330EG/GG (Electric/Gas)

Similar to DCCD330EG/GG except no digital cycle countdown.

## Commercial laundry security features/benefits

- Washer and dryer tops can be locked to cabinet for added security (lock not provided).
- Threaded bolt in meter case engages a bracket on the main washer support and dryer wrapper to maximize the resistance to vandalism.
- Heavy-duty access door on meter case accommodates lock to guard timing mechanism.
- Thick steel meter case with security hood protects slide and vault areas.
- The large coin vault capacity prevents coins from piling up and affecting coin entry.
- Tamper-resistant lid switch.
- Security screws on all coin and electrical enclosures.

*\*Includes 90-day limited parts and labor warranty (except coin system).  
3-year limited parts warranty; 5-year limited parts warranty on outer tub,  
inner basket, dryer drum and cabinet rust-through.  
See written warranty for details.*

## Heavy-duty stackable commercial dryers



### DDC4400T/DDC4500T (Electric/Gas) GE® stackable commercial dryer

- 5.4 cu. ft. capacity
- 3 cycles
- 3 heat selections
- Stacked pair
- “ON” indicator light
- Front serviceable
- Dryers shipped preassembled



**Coin mechanisms sold separately.**

## Frontload commercial washer and matching dryer



### WCCH404H GE frontload commercial washer

- 2.7 cu. ft. capacity
- ENERGY STAR® qualified
- Reverse wash action
- Uses up to 22 gallons of water
- 3 wash temperatures/  
1 rinse temperature
- Automatic water level adjustment
- Multiple wash cycles (Color Cottons, Permanent Press, White Cottons, Delicates)
- Stainless steel wash drum
- Detergent dispenser
- Fabric softener dispenser
- Bleach dispenser

**Coin mechanism sold separately.**



### DCCH43EH/GH (Electric/Gas) GE frontload commercial dryer

- 5.7 cu. ft. capacity
- 3 dry cycles
- 3 heat selections
- Lockable lint filter
- Reverse-a-Door
- DuraDrum™ finish

**Coin mechanism sold separately.**

### FPDW1

### Pedestal for use with frontload washer and dryer

Optional 12" pedestal raises the door opening and the height of the washer or dryer.

*3-year limited parts warranty; 5-year limited parts warranty on outer tub, inner basket, dryer drum and cabinet rust-through.  
See written warranty for details.*



## Smart Card commercial washer and dryer

GE® washer WNCK2050H*	
<b>Capacity</b>	
Capacity (cu. ft.)	3.2
<b>Features</b>	
Variable speed drive	●
Wash/spin speed comb.	3
Wash/rinse temperatures	3
Water levels	Adjustable
Digital cycle countdown	●
Number of wash cycles	5
White cottons	●
Colored cottons	●
Bright colors	●
Permanent Press	●
Delicate	●
Quiet performance	●
Lid instructions	●
LED indicators	●
<b>Smart Card features</b>	
Reader	ESD
Alphanumeric display	●
Control card	●
<b>Appearance</b>	
Colors available	White Brushed aluminum/ black/blue
Control panel	
<b>Weights &amp; Dimensions</b>	
Approx. shipping wt. (lbs.)	170

\*Smart Cards and value transfer machines sold separately.

GE dryer DNCK440EG* DNCK440GG*	
<b>Capacity</b>	
Capacity (cu. ft.)	7.0
<b>Features</b>	
Heat selections	4
Dry cycles	4
High Heat	●
Medium Heat	●
Low Heat	●
Cool down	●
Digital cycle countdown	●
Quiet performance	●
Lockable lint filter	●
LED indicators	●
Door swing	Reverse-a-Door
Drum finish	White DuraDrum™
<b>Smart Card features</b>	
Reader	ESD
Alphanumeric display	●
Control card	●
<b>Appearance</b>	
Colors available	White Brushed aluminum/ black/blue
Control panel	
<b>Weights &amp; Dimensions</b>	
Approx. shipping wt. (lbs.)	Elect. 130 Gas 125

\*Smart Cards and value transfer machines sold separately.

### Washer dimensions (in inches)

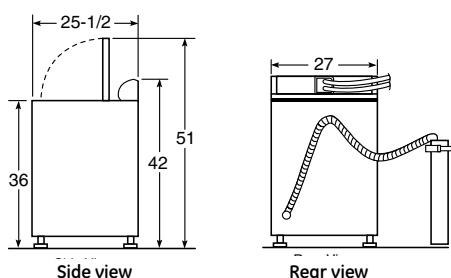

### Dryer dimensions (in inches)

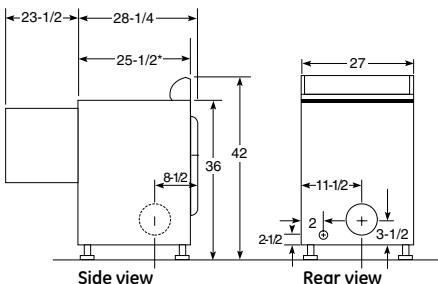

## Non-coin commercial washer and dryer

GE washer WNRD2050G	
<b>Capacity</b>	
Capacity (cu. ft.)	3.5 stainless steel
<b>Features</b>	
Variable speed drive	●
Wash/spin speed combinations	3
Wash/rinse temperatures	3
Water levels	4
Digital cycle countdown	●
Number of wash cycles	5
White cottons	●
Colored cottons	●
Bright colors	●
Permanent Press	●
Delicate	●
Spin only	●
Bleach dispenser	●
Fabric softener dispenser	●
Quiet performance	Deluxe quiet
Lid instructions	●
LED indicators	●
<b>Appearance</b>	
Colors available	White
Braille kit	14-D242
<b>Weights &amp; Dimensions</b>	
Approx. shipping wt. (lbs.)	160

Available in 4Q 07

GE dryer DNCD450EG DNCD450GG	
<b>Capacity</b>	
Capacity (cu. ft.)	7.0
<b>Features</b>	
Dry cycles	5
Cottons/high heat	●
Mixed loads/high heat	●
Perm. press/medium heat	●
Knits/low heat	●
Delicates/extra low heat	●
Temperatures	4
Air dry	●
Digital cycle countdown	●
Quiet performance	Hush quiet
Easy-clean lint filter	●
LED indicators	●
Door swing	Reverse-a-Door
Drum material	White DuraDrum
<b>Appearance</b>	
Colors available	White
Braille kit	14-D242
<b>Weights &amp; Dimensions</b>	
Approx. shipping wt. (lbs.)	Elect. 130 Gas 125

# Commercial washers and dryers

	GE® washers			
	WCRD2050H	WCCD2050H	WMCD2050H	WCCB1030H
<b>Capacity</b>				
Capacity (cu. ft.)	3.5	3.2	3.2	3.2
<b>Features</b>				
Wash time (excludes fill)	24 min.	24 min.	24 min.	24 min.
Water usage	29, 32/35 gal.	29, 32/35 gal.	29, 32/35 gal.	29, 32/35 gal.
<b>Controls</b>				
Coin box/card reader	Box shipped attached	Box shipped attached	Box shipped attached	Box shipped attached
Coin slide/dropbox/card reader	Customer-supplied	Customer-supplied	Greenwald VERT 8 included	Customer-supplied
Installed coin kit			●	
Display	LED	LED	LED	
Control type	Pushbutton w/ LED countdown	Pushbutton w/ LED countdown	Pushbutton w/ LED countdown	Pushbutton
Cycle indicator lights	●	●	●	●
<b>Washing features</b>				
Wash/rinse temperatures	3	3	3	3
Wash/spin speed combinations	2	2	2	1
Variable speed drive	●	●	●	●
Water levels	3 - adjustable	3 - adjustable	3 - adjustable	3 - adjustable
Agitator type	GentlePower™	GentlePower™	GentlePower™	GentlePower™
Wash basket type	Stainless steel	ExtrAction™	ExtrAction™	ExtrAction™
Number of wash cycles	5	5	5	3
<b>Cycles</b>				
Whites/cotton regular	●	●	●	●
Colors/cotton	●	●	●	●
Bright colors	●	●	●	●
Permanent press	●	●	●	●
Delicates cycle	●	●	●	●
<b>Unit features</b>				
Color lid instructions	●	●	●	●
Lid opening	Rear	Rear	Rear	Rear
Front serviceable	●	●	●	●
Armor guard protection	●	●	●	●
Steel drive transmission	●	●	●	●
Galvanized/E-coated steel	●	●	●	●
Auto balance suspension system	●	●	●	●
Spin speeds	630 RPM	630 RPM	630 RPM	630 RPM
Front leveling legs/rear self leveling system	●	●	●	●
Drain pump	TURBO 6-ft	TURBO 6-ft	TURBO 6-ft	TURBO 6-ft
<b>Appearance</b>				
Colors available	White	White	White	White
<b>Weights &amp; Dimensions</b>				
Approx. shipping weight (lbs.)	190	171	171	174
Dimensions (HxWxD in inches)	42 x 27 x 25-1/2			

**Note:** Coin box is preassembled to the washer. Includes accumulator. Coin mechanism must be ordered separately from supplier.

## Washer dimensions (in inches)

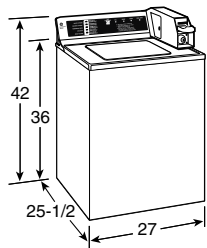

### Energy saving:

All wash cycles include energy-saving cold water rinse. Total cycle time—24 minutes plus fill time. Actual wash time is 8 minutes with a final spin speed of approximately 630 RPM.

### Circuit requirement:

An individual, properly grounded 15- or 20-amp branch circuit is required.

### Electrical rating:

115V, 60Hz

See Pub. No. 31-15400 for installation instructions.

**Note:** Coin slide or coin drop, coin vault, and locks for cover and meter case access door are not provided with washer.

	GE dryers			
	Electric Gas	DCCD330EG DCCD330GG	DCCB330EG DCCB330GG	DMCD330EH DMCD330GH
<b>Capacity</b>				
Capacity (cu. ft.)		7.0	7.0	7.0
<b>Features</b>				
<b>Control</b>		Coin-op	Coin-op	Coin-op
Coin box/card reader		Box shipped attached	Box shipped attached	Box shipped attached
Coin slide/drop box/card reader		Customer supplied	Customer supplied	Greenwald VERT 8 included
Installed coin kit				●
Display		LED		
Control type		Pushbutton w/LED countdown	Pushbutton	Pushbutton
Cycle indicator lights		●		●
<b>Heating features</b>				
Heats		3	3	3
Lint filter		Upfront	Upfront	Upfront
Dryer baffles/paddles		Plastic	Plastic	Plastic
Dryer drum type		Painted	Painted	Painted
Number of dry cycles		3	3	3
<b>Cycles</b>				
Whites/cottons/mixed loads		●	●	●
Knits/synthetics/delicates cycle		●	●	●
Permanent press		●	●	●
<b>Unit features</b>				
Quiet package		Quiet-By-Design™	Quiet-By-Design	Quiet-By-Design
Door opening		Reversible	Reversible	Reversible
Front serviceable		●	●	●
Armor guard protection		●	●	●
Galvanized steel cabinet		●	●	●
Leveling system		4-leg adjustable	4-leg adjustable	4-leg adjustable
Electric-vent positions		4 way-rear, bottom, left, right	4 way-rear, bottom, left, right	4 way-rear, bottom, left, right
Gas-vent positions		3 way-rear, bottom & left viewed from front	3 way-rear, bottom & left viewed from front	3 way-rear, bottom & left viewed from front
<b>Gas requirements</b>				
Gas rate		22000 BTU/Hr	22000 BTU/Hr	22000 BTU/Hr
Type		Natural gas	Natural gas	Natural gas
Options		LP kit available	LP kit available	LP kit available
Ignition		Glo-Bar	Glo-Bar	Glo-Bar
<b>Appearance</b>				
Colors available		White	White	White
<b>Weights &amp; Dimensions</b>				
Approx. shipping wt. electric (lbs.)		125	125	125
Approx. shipping wt. gas (lbs.)		135	135	135
Dimensions (HxWxD in inches)		42 x 27 x 25-1/2		

**Note:** Coin box is preassembled to the washer. Includes accumulator. Coin mechanism must be ordered separately from supplier.

## Dryer dimensions (in inches)

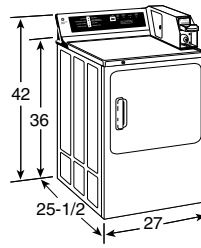

### Exhaust options:

**Electric:** 4-way venting: left, right, bottom and rear. Maximum recommended exhaust duct length is 45 feet of 4" rigid ducting with two 90° elbows and 4" dampered wall cap.

**Gas:** 3-way venting: left, bottom and rear. Maximum recommended exhaust duct length is 15 feet of 4" rigid ducting with two 90° elbows and a dampered wall cap. Dryer is shipped with exhaust to the rear.

(See Installation Instructions.)

See Pub. No. 31-1746 for installation instructions.

### Circuit requirements:

Electric An individual branch circuit fused for 30 amps is required for each dryer.

### Electric dryer rating:

240V, 60Hz, 5600W, 24A  
208V, 60Hz, 4400W, 22A

**Gas:** An individual branch circuit fused for 15 or 20 amps is required for each dryer.

### Gas dryer rating:

**Gas (BTU/Hr):** 20,000. Factory equipped for natural gas. Tested for LP gas. A conversion kit is required for LP gas. Check installation instructions for correct kit number. Have a qualified technician install the conversion kit. Equipped with energy saving Glo-Bar ignition.

**Dryer note:** Dryer wall outlet must be located within 36" of service cord entry and accessible when dryer is mounted in position.

**Note:** Dimensions and specifications shown here are correct at the time this sheet was printed. Before proceeding with construction or rough-in, check installation instructions that came with your unit. Specifications, dimensions and design are subject to change without notice.



## Stacked commercial dryers

	GE dryers	
Electric	DDC4400T	
Gas	DDC4500T	
<b>Capacity</b>		
Capacity (cu. ft.)	5.4	
<b>Features</b>		
Automatic dry control	●	
Anti-theft lint filter	●	
Heat selections	3	
Number of cycles	3	
Cottons	●	
Permanent press	●	
Delicates/Synthetic/Knits	●	
Front serviceable	●	
Reverse-a-Door	●	
Heavy-duty 1/4 HP motor	●	
<b>Appearance</b>		
Colors available	White	
<b>Weight &amp; Dimensions</b>		
Approx. shipping wt. (lbs.)	Electric	275
	Gas	274
Stacked (HxWxD in inches)	77 x 27 x 27	

**Note:** Coin box is preassembled to the washer. Includes accumulator. Coin mechanism must be ordered separately from supplier.

### Exhaust options:

**Electric:** 3-way venting: left, right, or rear. Maximum recommended exhaust duct length is 25 feet of 4" rigid ducting with two 90° elbows and 4" dampered wall cap. **Gas:** 2-way venting: left or rear. Maximum recommended exhaust duct length is 15 feet of 4" rigid ducting with two 90° elbows and a dampered wall cap. Dryer is shipped with exhaust to the rear. (See Installation Instructions.)

### Circuit requirements:

**Electric:** An individual branch circuit fused for 30 amps is required for each dryer.

### Electric dryer rating:

240V, 60Hz, 5600W, 24A  
208V, 60Hz, 4400W, 22A  
A special 208-volt heater, part number WE11X0101, is available to reduce drying time in 208-volt installations.

**Gas:** An individual branch circuit, properly grounded for a 3-prong outlet, fused for 15 or 20 amp, is required for each dryer.

### Gas dryer rating:

115V, 60Hz  
**Gas (BTU/Hr):** Maintains thermostatically controlled heat flow to dry clothes gently. Longer cool-down period on Permanent cool-down period on Permanent Press cycle helps prevent heat-set wrinkles. Separate thermostat controls lower temperatures for Knit cycle drying. Factory equipped for natural gas. Tested for LP gas. A conversion kit, WE25X0217, is required for LP gas. Check installation instructions for correct kit number. Have a qualified technician install the conversion kit.

### See Pub. No. 31-1723 for DDC4400T and Pub. No. 31-1724 for DDC4500T installation instructions.

**Note:** Dimensions and specifications shown here are correct at the time this sheet was printed. Before proceeding with construction or rough-in, check installation instructions that came with your unit. Specifications, dimensions and design are subject to change without notice. **Note:** Wall anchor chain provided for gas models only.

### Dimensions (in inches)

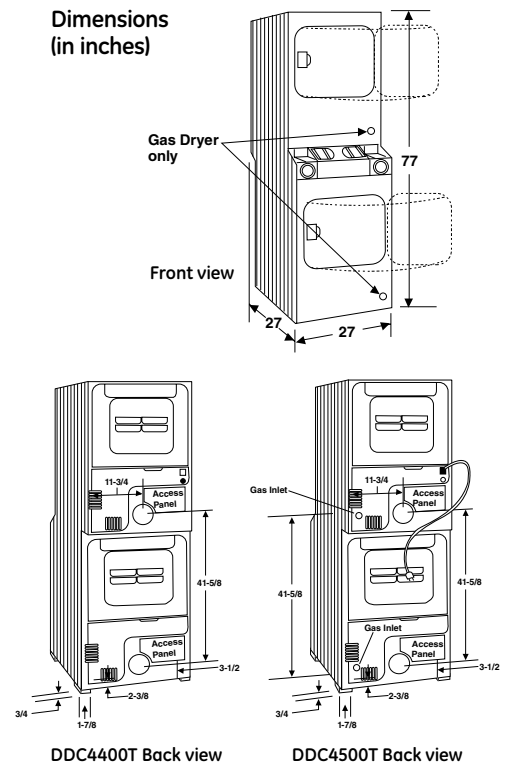

## Frontload commercial washer

	GE
	WCCH404H
<b>Capacity</b>	
Capacity (cu. ft.)	16 pound (2.7-3.1 per IEC)
<b>Features</b>	
Efficiency	ENERGY STAR® rated
Reverse wash action	●
Total water usage	Up to 22 gallons maximum
Wash/rinse temp.	3/1
Automatic water levels	●
Wash program	Standard wash + 3 rinses (26 min., excl. fill times)
<b>Wash options</b>	
Color cottons	●
Permanent press	●
White cottons	●
Delicates	●
Extraction	850rpm/210 G's
Automatic dispensing opt.	Detergent, liquid bleach, fabric softener
Suspension	Soft Mount
Drain pump	13 gpm @ 36 in head
Leveling system	Front leveling legs/rear rollers
Wash basket	Stainless steel
Door style	Glass
Pedestal available at additional cost	FPDW1 (12"H x 27"W x 24-3/8"D)
<b>Appearance</b>	
Colors available	White
Control panel	Brushed alum./black/blue
<b>Weights &amp; Dimensions</b>	
Dimensions (HxWxD inches)	36 x 26-3/4 x 24-3/4 (without coin box)
Approx. shipping wt. (lbs.)	217
<b>Power Ratings</b>	
Electrical requirements	120v, 60hz, 12.0 amps

**Note:** Coin box is preassembled to the washer. Includes accumulator. Coin mechanism must be ordered separately from supplier.

### Washer dimensions (in inches)

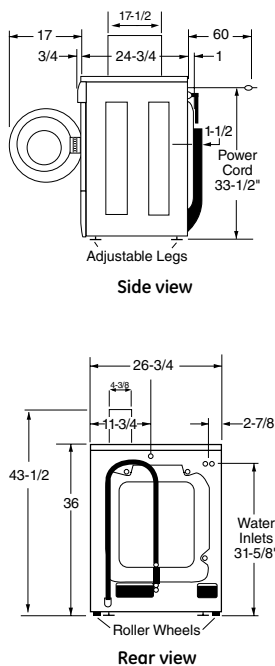

## Frontload commercial dryer

	GE
Electric	DCCH43EH
Gas	DCCH43GH
<b>Capacity</b>	
Capacity (cu. ft.)	5.7
<b>Features</b>	
Heat selections	3
Dry cycles	3
High heat	●
Medium heat	●
Low heat	●
Lockable lint filter	●
Door swing	Reverse-a-Door
Drum finish	White DuraDrum™
Front serviceable	●
Pedestal available at additional cost	FPDW1 (12"H x 27"W x 24-3/8"D)
<b>Appearance</b>	
Colors available	White
Control panel	Brushed alum./black/blue
<b>Weights &amp; Dimensions</b>	
Approx. shipping wt. (lbs.)	Elect. 116
	Gas 116

### Dryer dimensions (in inches)

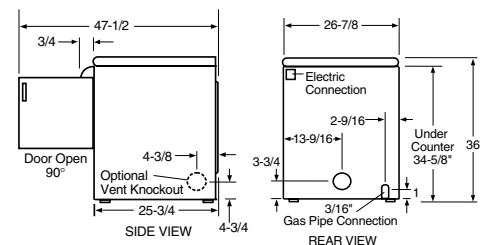

# GE® commercial laundry

Offering the best value with innovative features, benefits and durability!



## GE commercial laundry features

- ArmorGuard™ protection—Tested, rust-resistant, durable finish. No rust or chips.
- E-coated base cabinet for enhanced rust resistance.
- PermaTuf® II basket—No rust. No chipping.
- Auto balance suspension system—Helps reduce off-balanced loads. Featuring the innovative floating suspension system and balance ring.
- 3 adjustable water levels
- 24-minute wash cycle—24 minutes plus fill time.
- Front serviceable—All operational parts can be serviced without moving the units.
- Tamper-resistant lid switch—Helps reduce vandalized lid switches.
- Plus Smart Card capability—Accessory kit designed exclusively for GE.



Listed by  
Underwriters Laboratories

## GE Answer Center® saves you time.

800.626.2000

- The GE Answer Center® service is available to answer questions about Monogram®, GE Profile Performance Series™, GE Profile™, GE® and Hotpoint® features and installations.
- You and your customers can call toll-free before, during and after the sale.

## GE Sales Support

800.861.7206

## GE Parts

800.626.2002

### When You Want Parts To Fix It Yourself!

- We offer a complete line of parts, accessories and appliance care products for GE appliances and most other major brands too!
- Fast, convenient delivery direct to you.

### To learn more about GE commercial laundry:

Go to [www.gecommerciallaundry.com](http://www.gecommerciallaundry.com), or contact one of the support centers listed below:

Sales support	800.861.7206
Technical questions	901.387.2754
Parts fax number	866.841.9442
ESD	800.523.1510
Greenwald	800.221.0982



## A century of quality and innovation

For more than a century, GE has been committed to producing innovative products that change the way people live. The result of thorough research and rigorous testing, GE appliances are designed for years of dependable performance. Today, the GE tradition of quality and innovation continues.

## GE Consumer & Industrial

Appliances  
General Electric Company  
Louisville, KY 40225  
[ge.com](http://ge.com)

GE has a policy of continuous improvement of its products and reserves the right to change materials and specifications without notice.

© 2007 GE Company  
Pub. No. 14-5117 PC48435