

Use and Care Guide

**Beverage Center:
2175BEVS and 2175BEVOL2**



2175BEVS



2175BEVOL2

Introduction

Congratulations on your purchase of a U-Line refrigeration product. A pioneer in the field for more than 40 years, U-Line Corporation is the world's number one manufacturer of built-in, under-counter, specialty refrigeration and ice making products. U-Line dedicates 100% of its research and development to these products. The result: U-Line technology consistently leads the market with innovation, design, depth of product line and performance.

U-Line products are making life more convenient in homes, businesses, and hotels around the world. U-Line supports its products with a strong dealer network, and its commitment to quality even extends to environmentally safe packaging.

IMPORTANT

READ all of the instructions in this guide completely before operating the unit for the first time.

For future reference, keep this guide in a safe, accessible location. If you need additional information or assistance, please contact U-Line Corporation directly. Contact information appears on the rear cover of this guide.

If you have a problem with the operation of this product, the SERVICE section of this guide will assist you in quickly identifying common problems and provide information on possible causes and remedies. If your product needs service, contact U-Line directly.

Warranty Registration

Your U-Line Corporation Limited Warranty is located on the inside rear cover of this guide. To validate your warranty, the product and its original purchase date must be registered. A Warranty Registration Card has been included for this purpose in the package containing this manual. Complete and mail the Warranty Registration Card, or register your product online at www.U-LineService.com as soon as possible after purchase.

If your product registration is not on file and a request for warranty coverage is received, the date of sale to the U-Line Selling Dealer or Distributor will be established as the first date of warranty coverage for your product.

Please Record Your Model Information

When you request additional information or service, you will be asked for your products model and serial numbers. You can find this information on the serial plate located on the upper right or rear wall in the interior of your unit. This information also appears on the warranty registration card.



Figure 1

Please record the model number (**Figure 1, 1**), serial number (**Figure 1, 2**), date of purchase, and dealer contact information for your U-Line product below:

Model Number:

Dealer Name:

Serial Number:

Dealer Address:

Purchase Date:

Dealer Telephone:

Table of Contents

Introduction2
 Warranty Registration2
 Please Record Your Model Information2
1-Safety Precautions5
 Safety Alert Definitions5
 General Precautions5
2-Product Features6
 Échelon Beverage Center6
3-Optional Commercial Straight Handle6
4-Service6
5-Replacement Parts6
6-Operation7
 Initial Startup7
 Interior Lighting7
 Electronic Control Panel7
7-Normal Operating Sounds.....8
8-Wine Stocking Recommendations9
9-Storage, Vacation & Moving9
10-Product Disposal9
11-Wine Guide10
 Wine Selections Suggestions10
 Suggestions for Matching Food and Wine10
 Common Food and Wine Matches10
 Guide to Common Styles of Wine11
 Common Tasting Terms11
12-Cleaning and Maintenance12
 General Cleaning12
 Maintenance12
13-Troubleshooting Guide17
14-Electronic Control Quick Guide.....18
U-Line Corporation Limited Warranty19

This page intentionally left blank

1 Safety Precautions

IMPORTANT

PLEASE READ all instructions completely before attempting to install, operate, or service your unit.

- Proper installation procedures must be followed if this unit is being initially installed, or is moved to a new location after being in service. An **INSTALLATION GUIDE** for your unit, providing complete installation information is available from U-Line Corporation directly, and must be consulted before any installation is begun. U-Line contact information appears on the rear cover of this guide.
- This unit requires connection to a grounded (three-prong), polarized receptacle that has been placed by a qualified electrician in accordance with applicable electrical codes.

Safety Alert Definitions

Safety items throughout this guide are labeled with a Danger, Warning or Caution based on the risk type:

⚠ DANGER

Danger means that failure to follow this safety statement will result in severe personal injury or death.

⚠ WARNING

Warning means that failure to follow this safety statement could result in serious personal injury or death.

⚠ CAUTION

Caution means that failure to follow this safety statement may result in minor or moderate personal injury, property or equipment damage.

General Precautions

Use this appliance for its intended purpose only and follow these general precautions along with those listed throughout this guide:

⚠ DANGER

RISK OF CHILD ENTRAPMENT. Before you throw away your old refrigerator or freezer, take off the doors and leave shelves in place so that children may not easily climb inside.

⚠ WARNING

SHOCK HAZARD - Electrical Grounding Required.

- Never attempt to repair or perform maintenance on the unit until the electricity has been disconnected.
- Never remove the round grounding prong from the plug and never use a two-prong grounding adapter.
- Altering, cutting of power cord, removal of power cord, removal of power plug, or direct wiring can cause serious injury, fire and/or loss of property and/or life and will void the warranty.
- Never use an extension cord to connect power to the unit.
- Always keep your working area dry.

⚠ WARNING

The Anti-Tip Kit must be installed on this unit before it is used. Serious personal injury could occur.

⚠ CAUTION

- Use care when moving and handling the unit. Use gloves to prevent personal injury from sharp edges.
- If your model requires defrosting, **DO NOT** use any type of heater to defrost. Using a heater to speed up defrosting can cause personal injury and damage to the inner lining.

IMPORTANT

- Do not lift unit by door handle.
- Never install or operate the unit behind closed doors. Be sure front grille is free of obstruction. Obstructing free air flow can cause the unit to malfunction and may void the warranty.
- Failure to clean the condenser every three months can cause the unit to malfunction. This could void the warranty.
- Allow unit temperature to stabilize for 24 hours before use.
- If your model requires defrosting, never use an ice pick or other sharp instrument to help speed up defrosting. These instruments can puncture the inner lining or damage cooling unit.
- Use only genuine U-Line replacement parts. Imitation parts can damage the unit, affect its operation or performance and may void the warranty.

2 Product Features

Échelon Beverage Center

The Model 2175BEVS, 2175BEVOL2 Beverage Center will accommodate up to 16 standard 750 mL bottles of your favorite wines on its two upper, fully extendable, sliding wine racks. The Beverage Center also provides generous storage for non-wine beverages on two lower tempered shelves.

The Right Temperature for Wine

Your Beverage Center has been designed to provide two temperature zones within the cabinet so the specific storage requirements of your beverages can be satisfied. The upper wine rack zone maintains an approximate temperature of 45°F, and the lower shelf zone maintains an approximate temperature of 38°F.

NOTE: Product temperatures, not air temperatures, are referenced above.

- An electronic control panel with digital display allows you to display the interior temperature in the lower shelf zone and adjust the temperature setting. The electronic control and digital display provide an attractive appearance, and its method of control provides temperature settings for a variety of wine and non-wine beverages.
- An interior light will illuminate automatically as the door is opened, providing easy visual identification of the contents. You can also select two other modes of operation:
 - a. The interior light can be illuminated continuously while the door is closed for a four-hour period, without resetting the unit, providing a visible display of the Beverage Center contents.
 - b. A blackout mode allows you to darken the interior lighting and the LED display, while maintaining complete temperature control in the unit.
- The wine racks have a maple front trim that adds an attractive appearance to this model. The wood facing may be stained or replaced in its entirety with other woods or manufactured products (such as Corian® or Sandstone).
- Black vinyl wine racks blend with the wine bottles, placing greater emphasis on the wine bottles themselves. The vinyl holds the bottles more effectively than a chromed or painted finish.
- The wine racks slide out, and are fully extendable, providing access to all wine bottles, including those located on the rear portion of the rack.
- This model features maintenance-free automatic (cycle) defrost.

Échelon Beverage Models feature either a stainless steel or full overlay-ready door frame.

- a. Stainless steel units feature a wrapped 2 in. (5.1 cm) wide door frame, handle. Stainless steel doors are not field-reversible.

- b. Door full overlay wood frames are customer-provided, and are not supplied by U-Line.
- An optional commercial handle is available through the dealer to further customize your unit.

Features and specifications are subject to change without notice.

3 Optional Commercial Straight Handle

Stainless steel models are shipped from the factory equipped with the standard curved handle. An optional commercial straight handle can be purchased directly from your dealer. Order Part No. 14159-01.

4 Service

Before Calling for Service

If your U-Line product appears to be malfunctioning, read through the OPERATION section of this guide to ensure that the function of all controls are clearly understood. If the malfunction persists, the TROUBLESHOOTING GUIDE in this guide will assist you in quickly identifying common problems, and provide information on possible causes and remedies. Most often, this will resolve the problem without the need to call for service.

If Service is Required

If you do not understand a troubleshooting remedy, or your product needs service, contact U-Line Corporation directly. Contact information appears on the rear cover of this guide.

You will be asked for your product Model and Serial Numbers. This information should be recorded inside the front cover of this guide, following the product's original purchase. It also appears on the Model and Serial number plate located on the upper right or rear wall of the interior of your product.

5 Replacement Parts

When you need replacement parts, always request that genuine U-Line replacements be used. U-Line products have been designed and engineered using components that work efficiently, and provide superior service life and performance. The use of aftermarket parts or components may affect the safety, operation, performance or durability of your product, and may also void its warranty.

6 Operation

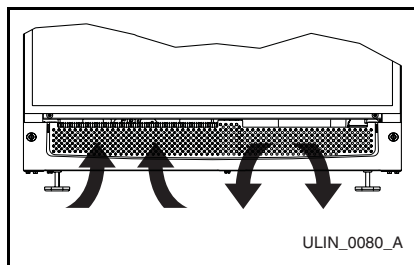

Figure 2

IMPORTANT

Proper air flow (Figure 2) is required for your unit to operate at its highest efficiency. A grille, located in the base of the unit, must not be blocked at any time, or your unit will not perform as expected.

Initial Startup

All U-Line units are shipped with controls that are preset. No initial adjustments are required.

IMPORTANT

U-Line recommends the unit be allowed to run overnight prior to loading with product.

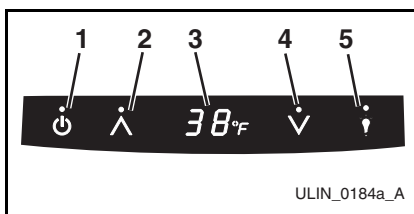

Figure 3

To turn the unit on or off, touch and hold the POWER icon (Figure 3, 1) on the display panel for approximately 10 seconds until the °F symbol flashes and release.

- A small LED above the icon will illuminate to confirm the touch of any controller icon.
- The display (Figure 3, 3) will show the unit set-point temperature when the unit is on and will show OFF when the unit is off.
- Turning the unit off will override any other control function.

Interior Lighting

The interior of the cabinet can be illuminated whenever the door is opened (default mode), illuminated for a four-hour period, or remained darkened (blackout mode).

The LIGHT icon (Figure 3, 5) on the control panel is used to change the lighting functions.

To illuminate the interior of the cabinet for a four-hour period:

1. Touch and release the LIGHT icon (Figure 3, 5) to switch from door-operated lighting control to continuous lighting (the °F symbol will flash briefly after the LIGHT icon is pressed).
2. To return to door-operated lighting control before the four-hour period is up, repeat Step 1.

To turn the lights and display OFF (blackout):

1. Touch and hold the LIGHT icon (Figure 3, 5) for ten seconds and release (the °F symbol will flash briefly at the end of the five second period).
2. The interior light and control display (Figure 3, 3) will go dark.

NOTE: Although the display will not be visible, the temperature controls in the unit remain active, and the interior temperature will be maintained.

3. To exit the blackout mode, repeat Step 1.

Electronic Control Panel

Your Beverage Center has been designed to provide two temperature zones within the cabinet so the specific storage requirements of your beverages can be satisfied.

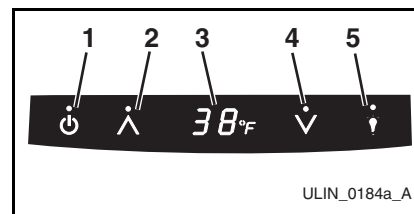

Figure 4

The electronic control with digital display (Figure 4) is configured to show a single temperature continuously. This set-point temperature is a base number used by the controller to maintain the temperature zones in your unit. The factory default set-point temperature is 38°F. This set-point temperature is used as a gauge if further temperature adjustments are required.

A DISPLAY OFF mode is available through the control panel. This mode allows you to control whether the display (**Figure 4, 3**) will be ON or OFF whenever the door is closed. The icon touch sequence that follows will switch between both modes:

NOTE: These are product temperatures, not air temperatures.

1. Touch and hold the WARMER icon (**Figure 4, 2**), and within five seconds press the POWER icon (**Figure 4, 1**) three times.
2. The display will be either visible or dark when the door is closed.
3. To return to the previous mode, repeat Step 1.

Temperature Display Selection

U-Line products supplied for 110 VAC operation have temperatures displayed in a default Fahrenheit (°F) configuration (**Figure 4, 3**). Models supplied for 220 VAC operation have temperatures displayed in a default Celsius (°C) configuration.

The display can easily be adjusted for either type of temperature display. Press and hold the LIGHT icon (**Figure 4, 5**) and within five seconds press the COOLER icon (**Figure 4, 4**) three times to change the display as desired.

Temperature Display

To display actual temperatures:

1. Press and hold the WARMER icon (**Figure 4, 2**) for approximately five seconds and release when the °F symbol in the display (**Figure 4, 3**) begins to flash.
2. After approximately 10 seconds, the display will return to the set-point temperature.

Adjusting Temperature

IMPORTANT

Adjust the set-point temperature in single increments, and wait 24 hours for the temperature to stabilize before rechecking.

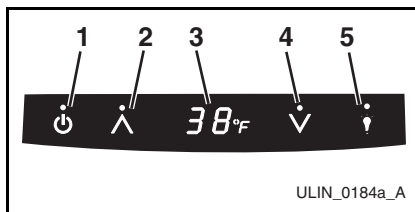

Figure 5

To adjust the set-point temperature:

1. Press and release either the WARMER icon (**Figure 5, 2**) or COOLER icon (**Figure 5, 4**) to put the controller in the SET TEMPERATURE mode. The °F symbol (**Figure 5, 3**) will begin to flash.

NOTE: If no further action is taken, this mode will self cancel in five seconds, and the original set-point temperature will be displayed.

2. While the °F symbol is flashing, press the WARMER or COOLER icon as required to adjust the set-point temperature.

The change will be set five seconds after adjusting the temperature and the new set-point temperature will be displayed.

7 Normal Operating Sounds

All models incorporate rigid foam insulated cabinets to provide high thermal efficiency and maximum sound reduction for its internal working components. In spite of this technology, your model may make sounds that are unfamiliar.

Normal operating sounds may be more noticeable because of the unit's environment. Hard surfaces such as cabinets, wood/vinyl/tiled floors and paneled walls have a tendency to reflect normal appliance operating noises.

Common refrigeration components, and a brief description of the normal operating sounds they make, are listed below.

NOTE: Your product may not contain all of the components listed.

- Compressor: The compressor makes a hum or pulsing sound that may be heard when it operates.
- Evaporator: Refrigerant flowing through an evaporator may sound like boiling liquid.
- Condenser Fan: Air moving through a condenser may be heard.
- Automatic Defrost/Drain Pan: Water may be heard dripping or running into the drain pan when the unit is in the defrost cycle.

8 Wine Stocking Recommendations

Specially designed wine racks allow for the proper horizontal storage of wine. The bottles are properly positioned so the wine remains in contact with the cork to assure that the cork does not become dry.

Stock your unit as follows:

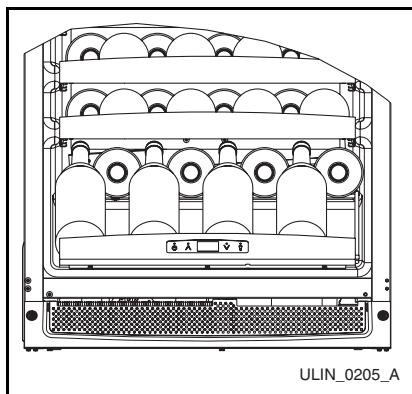

Figure 6

1. The wine racks should be stocked beginning with the lowest rack, at the back, and working forward. Stagger the bottles as shown (**Figure 6**).

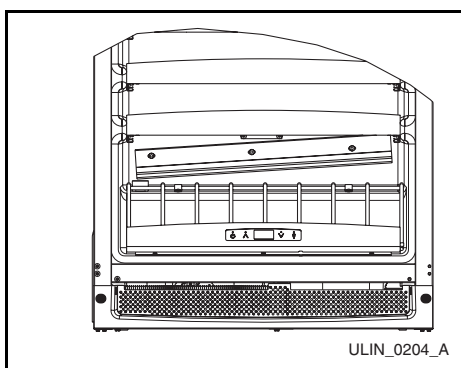

Figure 7

NOTE: If your unit is equipped with a bottom display rack (**Figure 7**), stock that rack first.

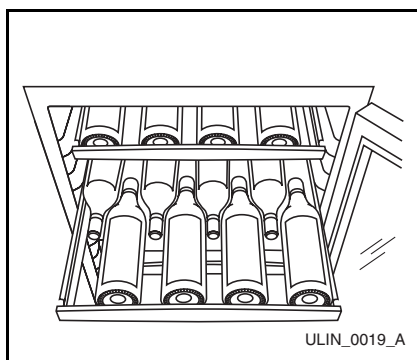

Figure 8

NOTE: After stocking, allow unit to run for 24 hours to stabilize product temperatures.

2. Repeat Step 1 to stock the next higher rack, and continue until all racks are filled (**Figure 8**).

9 Storage, Vacation & Moving

If the unit will not be used for an extended period, or otherwise stored, follow these steps completely:

WARNING

Electrical Shock Hazard. Disconnect power before servicing. Before operating, replace all panels. Failure to do so may result in death or electrical shock.

1. Remove all consumable contents from the unit.
2. Disconnect the power cord from its outlet, and leave it disconnected until the unit is returned to service.
3. Clean and dry the interior of the cabinet (See **CLEANING AND MAINTENANCE: GENERAL CLEANING**).
4. During periods of non-use, the cabinet must remain open to prevent the formation of mold and mildew. Open door a minimum of 2 in. (5 cm) to provide the necessary ventilation.

10 Product Disposal

If the unit is being removed from service for disposal, check and obey all Federal, State and/or Local regulations regarding the disposal and recycling of refrigeration appliances, and follow these steps completely:

1. Remove all consumable contents from the unit.
2. Disconnect power to the unit and unplug the power cord from its outlet.

DANGER

RISK OF CHILD ENTRAPMENT. Before you throw away your old refrigerator or freezer, take off the doors and leave shelves in place so that children may not easily climb inside.

3. Remove the cabinet door.

11 Wine Guide
Wine Selections Suggestions

Selecting the right wine for the right occasion can sometimes be a seemingly awkward or difficult task for the beginning wine enthusiast. We would therefore like to present you with a few suggestions which may provide a little more confidence and enjoyment when choosing and serving your wines.

When selecting wines, keep an open mind and do not be afraid to be adventurous. Do not view the subject of wine so seriously it discourages you from learning and discovering for fear of embarrassment if something is incorrect. Wine is best viewed as a hobby and enjoyed.

When assembling your collection, try not to become obsessed with "Vintages." Although a chart can be a useful tool, generalizations about a specific year have led more than one collector to disappointment. In many instances an "Off Year" will provide a better value and more drinking enjoyment.

The primary guideline to the subject of wine is your own palate. Do not be afraid to make mistakes. Experiment, discover, but most of all, enjoy yourself and your new U-Line product.

Suggestions for Matching Food and Wine

Although there are no hard fast rules for matching wine to food, observe some guidelines. Delicate dishes should be accompanied by lighter more delicate wines. Full-flavored foods should be matched with fuller-bodied wines.

As a general rule, one should aim to ascend in flavor and quality of wines served.

Table 1

Serve a:	Before a:
DRY wine	SWEET wine
WHITE wine	RED wine
YOUNG wine	OLD wine
LIGHT-BODIED wine	FULL-BODIED wine

Any step back in quality will be noticed. If a fine wine is tasted prior to a lesser wine, many of the fine wine's subtle qualities may be missed.

Common Food and Wine Matches
Table 2

Foods	Wines
Fish, Shell Fish, Crab, Oysters	Dry White Wines, Light Sparkling or Extra Dry Champagne
Beef, Venison	Full-Bodied Red Wines
Pork, Veal, Lamb and Poultry	Light-Bodied Red Wines
Fruit	Sweet White and Sparkling Wines

Guide to Common Styles of Wine

Red Wines		
Full-Bodied Dry	California French Italian	Zinfandel, Cabernet Rhone, Chateauf-neuf-du-Pape Barbaresco, Barolo
Medium-Bodied Dry	California French	Pinot Noir Bordeaux, Burgundy
Light-Bodied Dry	French Italian	Beaujolais Chianti, Bardolino
White Wines		
Full-Bodied Dry	California French	Chardonnay Montrachet, Meursault Puligny-Montrachet
Medium-Bodied Dry	California French	Sauvignon-Blanc Pouilly-Fuisse, Sancerre, Vouvray, Graves
Light-Bodied Dry	French	Chablis, Muscadet, Pouilly-Fume
Full-Bodied, Very Sweet	Germany Freny Hungary	Beerenauslese Sauternes Tokay
Medium-Bodied, Semi-Sweet	California Germany	Gewurtztraminer Liebfraumilch
Light-Bodied Off Dry	Germany	Rhine, Mosel, Riesling

Common Tasting Terms

Terminology	Description
Acidity	A critical element of wine that is responsible for preserving the wines freshness. Excess acidity results in an overly tart and sour wine.
Balance	A desired trait where tannin, fruit and acidity are in total harmony. Wines with good balance tend to age gracefully.
Body	The weight and presence of wine in the mouth provided by the alcohol and tannin level. Full-bodied wines tend to have this strong concentration.
Bouquet	The blending of a wine's aroma within the bottle over a period of time, caused by volatile acidity.
Complex	A subjective term often used in tasting. A wine is said to be complex if it offers a variety of flavors and scents that continue to evolve as it develops.
Flabby	A wine that lacks structure, or is heavy to the taste, lacks acidity.
Full-Bodied	Wine high in alcohol and extract, generally speaking, fills the mouth, powerful.
Lean	Generally describes wines that are slim, lacking of generosity or thin.
Oaky	A desirable flavor imparted to wine if done in moderation. Most wines are aged in oak barrels one to three years, thereby receiving this toasty oak characteristic. However, if a weak wine is left in contact too long with an oak barrel it will tend to be overpowered with an oaky taste.
Tannin	Tannins are extracted from the grape skins and stems and are necessary for a well-balanced red wine. Tannins are easily identified in wine tasting as the drying sensation over the gums. Tannins generally fade as a wine ages.

12 Cleaning and Maintenance

Proper maintenance of your U-Line product will ensure efficiency, top performance and long life. The maintenance intervals listed are based on normal conditions. You may want to shorten the intervals if you have pets or other special considerations.

Exterior Cleaning (As Required)

- Surfaces may be cleaned with a mild detergent and warm water solution. Do not use solvent-based or abrasive cleaners. Use a soft sponge and rinse with clean water. Wipe with a soft, clean towel to prevent water spotting.

Stainless Steel Doors:

- Stainless steel surfaces and components can discolor when exposed to chlorine gas, pool chemicals, salt water or cleaners with bleach.
- Keep your stainless steel unit looking new by cleaning with a good quality all-in-one stainless steel cleaner/polish on a monthly basis. For best results use Claire® Stainless Steel Polish and Cleaner, which can be purchased from U-Line Corporation, Part No. 173348. Comparable products are acceptable. Frequent cleaning will remove surface contamination that could lead to rust. Some installations may require cleaning on a weekly basis.
- **Do not clean with steel wool pads.**
- **Do not use cleaners that are not specifically intended for stainless steel on stainless steel surfaces (this includes glass, tile and counter cleaners).**
- If any surface discoloring or rusting appears, clean it quickly with Bon-Ami® or Barkeepers Friend Cleanser® and a non-abrasive cloth. Always clean in the direction of the grain. Always finish this process with Claire Stainless Steel Polish and Cleaner or comparable product to prevent further problems.
- **Using abrasive pads such as Scotchbrite™ will cause the graining in the stainless steel to become blurred.**
- Rust that is not cleaned up promptly can penetrate into the surface of the stainless steel and complete removal of the rust may not be possible.

Interior Cleaning (As Required)

- Disconnect power to the unit. Clean the interior and all removed components using a mild non-abrasive detergent and warm water solution applied with a soft sponge or non-abrasive cloth. Rinse the interior using a soft sponge and clean water.
- **Do not use any solvent-based or abrasive cleaners. These types of cleaners may transmit taste to the interior products and damage or discolor the interior.**

Maintenance

Proper maintenance of your U-Line product will ensure efficiency, top performance and long life. The maintenance intervals listed are based on normal conditions. You may want to shorten the intervals if you have pets or other special considerations.

Defrosting

Automatic (Cycle) Defrost Models

Automatic defrost models do not produce frost in normal operating conditions. However, a frost pattern may be noticed on the interior walls if the unit is repeatedly opened in a high heat or high humidity location. If this frost pattern does not clear within 24 hours, your unit will require manual defrosting.

WARNING

DO NOT use any type of electrical heating device, ice pick, knife or other sharp instrument to defrost; this could damage the inner lining or refrigeration system and void the warranty.

IMPORTANT

The drain pan was not designed to capture the water created when manually defrosting. To prevent water from overflowing the drain pan, place towels or other absorbent materials over the interior drain trough, under the evaporator (Figure 9, 1), before defrosting.

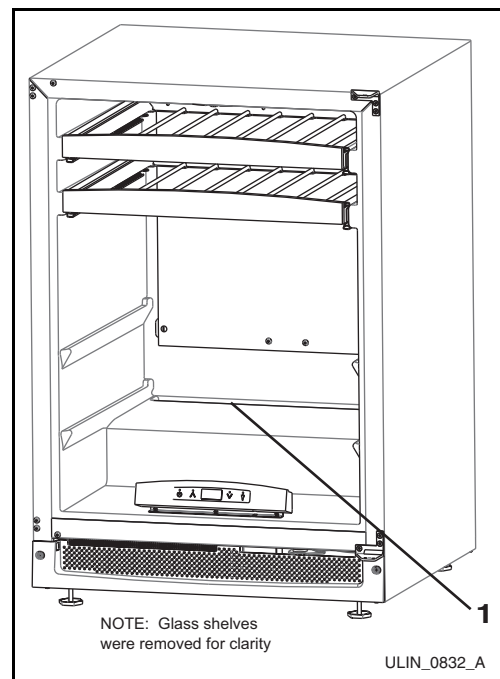

Figure 9

To defrost:

1. Turn unit off.
2. Remove all products from the interior and prop the door in an open position (2 in. (5 cm) minimum).
3. Allow the frost to completely melt naturally. Clean the interior and all removed components using a mild non-abrasive detergent and warm water solution applied with a soft sponge or non-abrasive cloth.

NOTE: DO NOT use any solvent-based or abrasive cleaners. They will discolor or damage the interior.

4. Dampen a soft sponge or non-abrasive cloth in clean water and wipe down the cabinet interior and removed components to remove any detergent residue. Rinse the sponge or cloth in clean water and repeat as necessary until the cabinet and components are clean.
5. When the interior is dry, turn unit back on.

Condenser Cleaning

Interval - Every Three Months

To maintain operational efficiency, keep the front grille free of dust and lint and clean the condenser every three months. Depending on environmental conditions, more or less frequent cleaning may be necessary.

⚠ WARNING

Disconnect electric power to the unit before cleaning the condenser.

To remove and replace the grille for access to the condenser fins, follow this procedure:

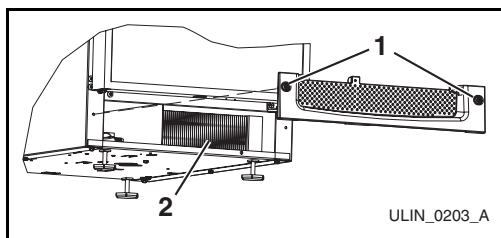

Figure 10

1. Disconnect electrical power to the unit.
2. Loosen two screws (**Figure 10,1**) completely.

NOTE: Screws are held in the grille by o-ring retainers, and will not come free of the grille.

3. Remove the grille.

⚠ WARNING

DO NOT touch the condenser fins. The condenser fins are SHARP and can be easily damaged.

⚠ CAUTION

DO NOT use any type of cleaner on the condenser unit.

4. Clean the condenser coil (**Figure 11, 2**) using a soft brush with a “combing” action or vacuum cleaner. Do not touch the condenser coil.
5. Position the grille to align the mounting screws with the holes in the cabinet.
6. Secure, but do not over-tighten both grille screws.
7. Reconnect power to the unit.

Leveling

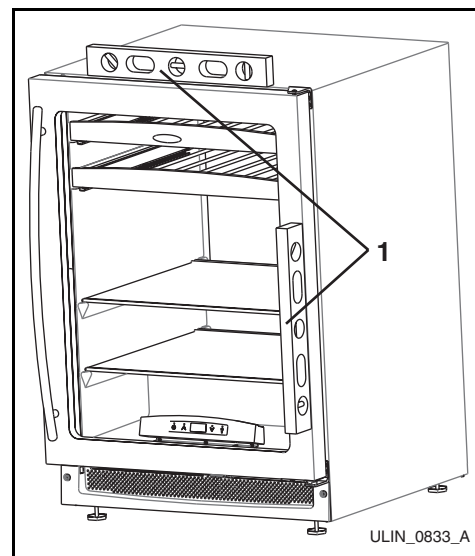

Figure 11

1. Use a level to check the levelness of the unit from front to back and from side to side. Level should be placed along top edge and side edge as shown (**Figure 11**).

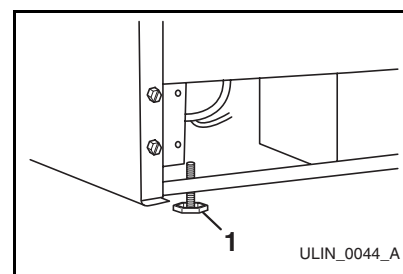

Figure 12

2. If the unit is not level, adjust the feet on the corners of the unit as necessary (**Figure 12**).
3. Check the levelness after each adjustment and repeat the previous steps until the unit is level.

Door Alignment Check and Adjustment

IMPORTANT

When properly aligned:

- The door will not be flush with the top of the cabinet. The top edge of the door will be 1/8 in. (3.175 mm) below the cabinet top.
- The door gasket will be firmly in contact with the perimeter of the cabinet and not pinched on the hinge side of the door.

The following procedure will correct for up to 1/4 in. misalignment:

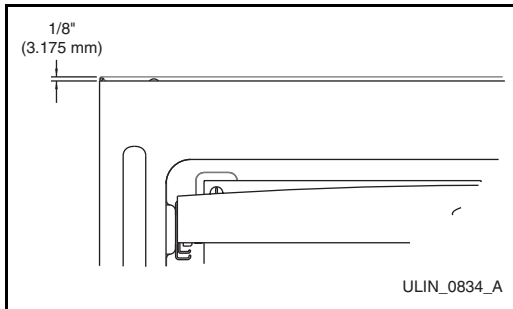

Figure 13

1. Compare the top edge of the door (opposite the hinges) to the top edge of the cabinet (**Figure 13**) and note the type (up or down) of adjustment needed.

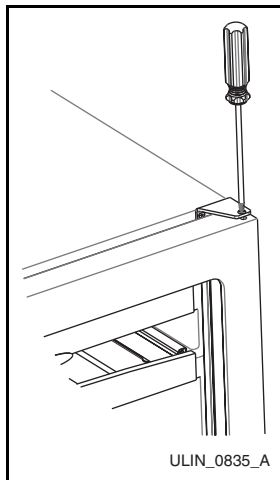

Figure 14

2. Remove the top hinge pivot pin with a Phillips screwdriver (**Figure 14**) and lift door off bottom hinge pin. Be careful not to lose the door closer insert sets.

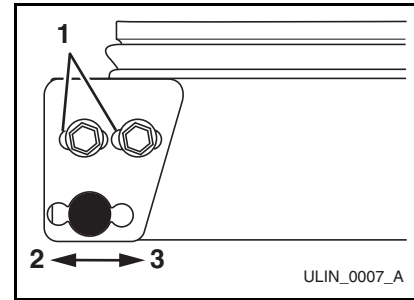

Figure 15

3. Turn the door upside down and inspect the hinge plate mounting holes.
 - Your plate has slotted mounting holes (**Figure 15, 1**). Loosen but do not remove the two hinge plate screws.
4. If door edge opposite the hinges needs to move up, move plate toward outside of door (**Figure 15, 2**). If door edge needs to move down, move plate toward inside of door (**Figure 15, 3**). Repeat until top edge of door is parallel with top of cabinet and tighten screws securely (**Figure 15, 1**).

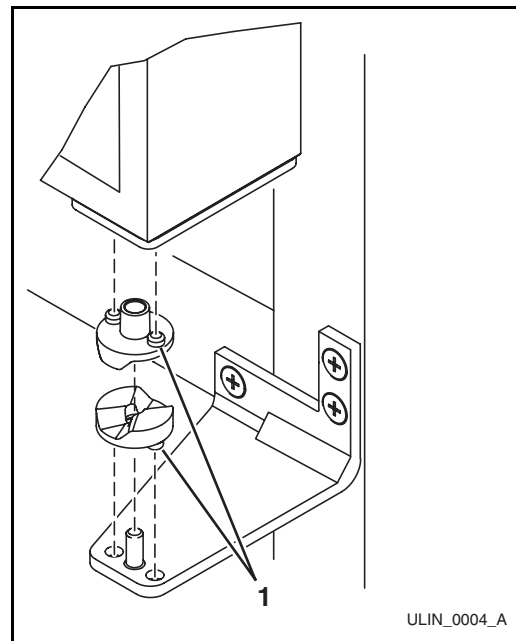

Figure 16

5. After adjustment is complete, remove the door closers from the bottom hinge, clean thoroughly and apply petroleum jelly to the mating surfaces of the closers. Be sure that bosses on closers (**Figure 16, 1**) align with holes in the door and bottom cabinet hinge plates. Mount door and install top hinge pivot pin.

Light Bulb Replacement

To replace the light bulb in your U-Line unit:

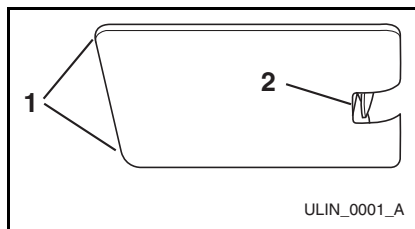

Figure 17

1. Grasp the edges of the light housing lens (**Figure 17, 1**) opposite the exposed tab and gently push the lens toward the tab (**Figure 17, 2**).
2. Pull the edge of the lens down (**Figure 17, 1**) and swing it out of the light housing.

IMPORTANT

ALWAYS use a genuine U-Line replacement bulb (P/N 31317) in the light housing. Use of any other bulb within the housing will generate excessive heat, causing damage to the light housing and cabinet interior, and will compromise the precise temperature control of your unit.

3. Replace the bulb only with a genuine U-Line P/N 31317 replacement.

Replace the lens by first inserting the tab side back into the housing at a slight angle. While gently pushing the lens towards the tab end, push the free end up into the housing, and release when you will hear a snap/click.

Wine Rack Removal/Installation

To remove a rack from the cabinet:

1. Grasp the end of the rack, and gently slide it out until it stops.
2. Remove any bottles stored on the rack.

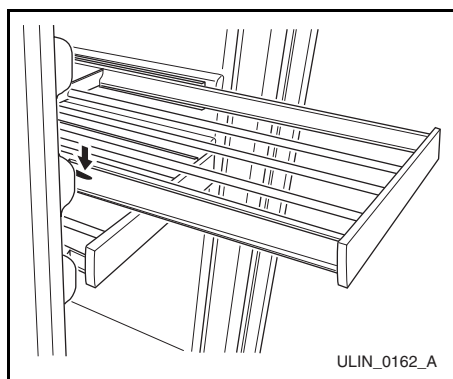

Figure 18

3. Press the left rack release lever (**Figure 18**) down, and at the same time, lift the corresponding right rack

release lever up, and pull the rack out until it is free of the tracks and the cabinet.

IMPORTANT

Do not remove the track side rails from the cabinet.

To insert a rack in the cabinet:

1. Align the left and right rack channels with the tracks in the cabinet, and ensuring an even track engagement on both sides, gently push the rack into the cabinet until it stops.
2. Before reloading the rack, ensure proper operation of the travel stops in the left and right track rails by pulling the rack out gently until it completely stops.

Wood Trim Finishing

The U-Line Beverage Center is equipped with wood-trimmed wine racks that are coated at the factory with a clear vinyl sealer, which will adequately protect the wood in normal usage. A final finish coat was not applied so that the wood trim could be stained to match décor. The trim on the racks may be coated with a final finish or stained.

To remove the wood trim surrounding the controller:

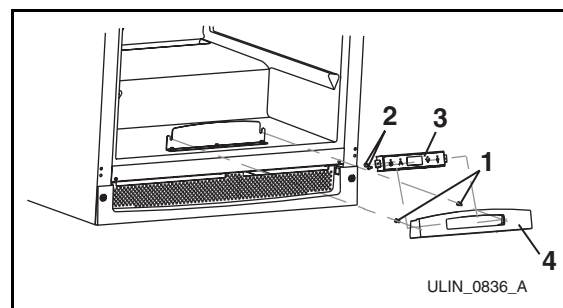

Figure 19

1. Loosen the two screws holding the controller to the mounting bracket (**Figure 19, 1**).
2. Lift the controller housing (**Figure 19, 4**) and then rotate forward to expose the wiring harness on the back.
3. Disconnect the wiring harness from the controller (**Figure 19, 3**).
4. Remove the two screws holding in the controller housing (**Figure 19, 2**), then remove from wood.

NOTE: Carefully remove controller from housing. The glass front is not secured to the controller. Glass may fall and break, which is not covered under warranty.

5. After staining, installation is the reverse.

Be sure to align glass with controller when installing, otherwise controller may not work correctly.

⚠ WARNING

To prevent permanent damage to the inner liner of your unit, the wood trim MUST be removed from the unit for staining and/or finishing. Allow stain/finish to dry thoroughly (at least 24 hours per coat) in accordance with the product manufacturer's instructions prior to reinstallation. Failure to do so may cause the inner liner of the unit to have a permanent odor, which is not covered by the warranty.

If staining the trim is desired, it must be done before the application of any type of final finish. Review the following staining/final finish and final finish-only guidelines when staining/ and or sealing the wood to ensure proper adhesion and durability of the finish.

NOTE: Glass in door is tinted. Stain may look darker when door is closed.

Staining and final finish application:

1. Remove all screws securing wood trim to interior components, and remove the trim from the cabinet interior.

IMPORTANT

DO NOT use oil-based stains on wood trim. Vapors from oil-based stains will permanently penetrate the liner and will not dissipate over time.

2. Apply Minwax® Water-Based Wood Stain to wood with a synthetic bristle brush or a foam applicator. Allow stain to penetrate approximately three minutes. Before the stain is dry, take a stain dampened rag and remove any excess stain remaining. Wipe in the direction of the grain with medium pressure to achieve the desired stain color.
3. After two hours, repeat step 2. This will even out the color of the wood.

4. Allow stain to dry for a minimum of three hours before applying the final finish.
5. If desired, sand the wood with very fine sandpaper to smooth the surface after the staining process.
6. Remove all dust from the wood, and apply one coat of Minwax® Polycrylic® Protective Finish using a synthetic bristle brush to the wood. This finish should be applied in a thin coat following the direction of the grain. Apply the finish to the back and sides of the wood first, and allow it to dry for two hours. Apply the finish to the front side of the wood next, and allow it to dry for two hours. Sand with very fine 220 grit sandpaper. Apply two additional coats of the finish in the same manner, but do not sand the trim after the final third coat is applied.
7. Allow the final coat to dry for 24 hours before reinstalling the trim to the cabinet interior components.

Final finish-only application:

1. Remove all screws securing wood trim to interior components, and remove the trim.
2. Lightly scuff sand the wood trim with 280 or finer grit sandpaper.
3. Remove sanding dust with a clean, dry cloth.
4. The factory-applied seal is compatible with virtually all finishes. A low odor, water clean up, quick-drying finish such as Minwax® Polycrylic® Protective Finish is recommended (Minwax® Polycrylic® is an ultra fast-drying water-based finish). Apply a thin coat of a clear, protective finish, following the container label directions.
5. Lightly sand and reapply if desired.
6. Allow the final coat to dry for 24 hours before reinstalling the trim to the cabinet interior components.
7. Allow the final coat to dry for 24 hours before reinstalling the trim to the cabinet interior components.

















13 Troubleshooting Guide



ELECTROCUTION HAZARD
Never attempt to repair or perform maintenance on the unit until the main electrical power has been disconnected.







PROBLEM	POSSIBLE CAUSE	REMEDY
Unit does not operate and electronic display is blank.	No electrical supply	Plug unit in or check circuit breaker.
No interior light	Loose or burned out bulb	Tighten or replace bulb (See MAINTENANCE; LIGHT BULB REPLACEMENT).
Electronic display is blank and interior light is OFF with door OPEN.	Unit is in blackout mode lighting mode.	Exit blackout mode (See OPERATION; INTERIOR LIGHT CONTROL).
Electronic display is blank and interior light is ON with door OPEN.	A display function has changed.	Touch and hold the warmer temperature button and touch and release the POWER button three times, then release the temperature button. The display should become visible.
Electronic display shows repeating, randomly flashing symbols and partial characters.	A factory control mode has been inadvertently entered.	Touch and hold the warmer temperature button and touch and release the LIGHT button three times, then release the temperature button to exit the factory control mode. The set-point temperature should now be displayed.
Electronic display shows: 0, 1 to 26, or 99.	A factory control mode has been inadvertently entered.	Repeatedly touch the warmer temperature button to advance any number shown to 99 and touch and release the LIGHT button. The set-point temperature should now be displayed.
Electronic display shows E3.	Door has been left open longer than 20 minutes.	Close door completely. The set-point temperature should now be displayed.
Electronic display shows ER.	The unit is displaying an error code.	Record the error code(s) displayed and call for service.
Unit not cold enough. Check temperatures (See OPERATION for approximate temperatures).	Control set too warm	Set control to a cooler setting (See OPERATION). Allow 24 hours for temperature to stabilize.
	Airflow to front grille blocked	Airflow must not be obstructed to front grille (See OPERATION).
	Dirty condenser coils	Clean condenser (See MAINTENANCE; CONDENSER CLEANING).
	Door gasket not sealing properly	Door adjustment required (See MAINTENANCE; DOOR ALIGNMENT CHECK AND ADJUSTMENT).
	Inaccurate temperature reading	Properly check temperature (See OPERATION).
Unit is too cold. Check temperatures (See OPERATION for approximate temperatures)	Control set too cold	Set control to a warmer setting (See OPERATION). Allow 24 hours for temperature to stabilize.
The unit frosts up.	High ambient temperatures or humidity	Defrost unit manually (See MAINTENANCE; DEFROSTING).
	Door gasket not sealing	Adjust door (See MAINTENANCE; DOOR ALIGNMENT AND ADJUSTMENT).

14 Electronic Control Quick Guide
All Models







Task	Touch	Touch	Display	Comment
Turn ON/OFF	 Hold 10 seconds	Release when °F flashes.	 or 	
Adjust Temperature	 or  Touch and release	 or  Touch to change temperature		°F flashes after first touch, set-point saved after 5 seconds of inactivity and °F stops flashing.*
View Actual Temperature	 Hold 5 seconds	Release when °F flashes.		For Wine Coolers, see Use and Care Manual.
Change °F-°C	 Hold	  	 or 	Repeat to switch back.
Blackout Mode	 Hold 10 seconds		Display (and cabinet light) not operable in Blackout Mode.	Hold light for 10 seconds to exit.

* Drawer Wine Cooler: Initially, top bar will flash to set to zone. After five seconds of inactivity (or touching light button), the bottom zone (bottom bar on F flashing) can be adjusted. After five seconds of inactivity, set-point will be stored in unit.















Glass Door Models

Task	Touch	Touch	Display	Comment
Cabinet Light				Light normally goes on/off with door opening. Pressing light button will turn interior light on for 4 hours, then it will turn off.
Display Off Mode	 Hold	  		Display off when door is closed (unless cabinet light is switched on). Repeat to switch back.

All Ice Makers

Task	Touch	Touch	Display	Comment
Ice Maker Off Mode	 Hold	  	 	Repeat to switch back

Clear Ice & Clear Combo Only

Task	Touch	Touch	Display	Comment
Clean Cycle	 Hold	  		Will automatically return to ice production when clean cycle is complete.
Ice Thickness Adjustment	 Hold	  		Use warmer/colder to scroll.
Temporary Shutdown (Office Mode)	 Hold	  		Ice maker will automatically turn back on in three hours.

NOTE: 38°F is an example; the display will vary with actual set-point.

IMPORTANT

Factory recommended set-point is 38°F for refrigerators and beverage centers, and 50°F for wine coolers.

U-Line Corporation Limited Warranty

U-Line Corporation warrants each U-Line product to be free from defects in materials and workmanship for a period of one year from the date of purchase; and warrants the sealed system (consisting of the compressor, the condenser, the evaporator, the hot gas bypass valve, the dryer and the connecting tubing) in each U-Line product to be free from defects in materials and workmanship for a period of five years from the date of purchase. During the initial one-year warranty period for all U-Line products U-Line shall: (1) at U-Lines option, repair any product or replace any part of a product that breaches this warranty; and (2) for all Marine, RV and Domestic U-Line products sold and serviced in the United States (including Alaska and Hawaii) and Canada, U-Line shall cover the labor costs incurred in connection with the replacement of any defective part. During years two through five of the warranty period for the sealed system, U-Line shall: (1) repair or replace any part of the sealed system that breaches this warranty; and (2) for all Marine, RV and Domestic U-Line products sold and serviced in the United States (including Alaska and Hawaii) and Canada, U-Line shall cover the labor costs incurred in connection with the replacement of any defective part of the sealed system. All other charges, including transportation charges for replacements under this warranty and labor costs not specifically covered by this warranty, shall be borne by you. This warranty is extended only to the original purchaser of the U-Line product. The Registration Card included with the product should be promptly completed by you and mailed back to U-Line or you can register on-line at www.U-LineService.com.

The following are excluded from this limited warranty: installation charges; damages caused by disasters or acts of God, such as fire, floods, wind and lightning; damages incurred or resulting from shipping, improper installation, unauthorized modification, or misuse/abuse of the product; customer education calls; food loss/spoilage; door and water level adjustments (except during the first 90 days from the date of purchase); defrosting the product; adjusting the controls; door reversal; or cleaning the condenser.

If a product defect is discovered during the applicable warranty period, you must promptly notify either the dealer from whom you purchased the product or U-Line at P.O. Box 245040, Milwaukee, Wisconsin 53224 or at 414-354-0300. In no event shall such notification be received later than 30 days after the expiration of the applicable warranty period. U-Line may require that defective parts be returned, at your expense, to U-Lines factory in Milwaukee, Wisconsin, for inspection. Any action by you for breach of warranty must be commenced within one year after the expiration of the applicable warranty period.

This limited warranty is in lieu of any other warranty, express or implied, including, but not limited to any implied warranty of merchantability or fitness for a particular purpose; provided however, that to the extent required by law, implied warranties are included but do not extend beyond the duration of the express warranty first set forth above. U-Lines sole liability and your exclusive remedy under this warranty is set forth in the initial paragraph above. U-Line shall have no liability whatsoever for any incidental, consequential or special damages arising from the sale, use or installation of the product or from any other cause whatsoever, whether based on warranty (express or implied) or otherwise based on contract, tort or any other theory of liability.

Some states do not allow limitations on how long an implied warranty lasts or the exclusion or limitation of incidental or consequential damages, so the above limitations may not apply to you. This warranty gives you specific legal rights, and you may also have other rights which vary from state to state.



For General Inquiries:

P.O. Box 245040
Milwaukee, Wisconsin
53224-9540 U.S.A.
Phone (800) 779-2547
FAX (414) 354-5696
www.U-Line.com

For Service and Parts Assistance:

Phone (800) 779-2547
(414) 354-0300
FAX (414) 354-5696
Email:
OnLineService@U-Line.com
www.U-LineService.com
E-mail:
OnlineParts@u-line.com

Échelon Series

For more than four decades, U-Line has distinguished itself as the leader in built-in under-counter ice making, refrigeration and wine storage appliances.

An INSTALLATION MANUAL for your unit, providing complete installation information, is available for download at www.U-Line.com. Information for custom panel inserts per model, including panel size, and instructions are available by visiting www.U-Line.com.

When you need replacement parts, always request genuine U-Line replacements be used. Visit www.U-Line.com to locate a parts distributor in your area.

U-Line Corporation, located in Milwaukee, WI, is a family operated manufacturer of built-in undercounter ice makers, Combo® ice maker/refrigerators, Wine Captain® wine storage units, refrigerators, refrigerated drawers and refrigerator/freezers.