

SERVICE DATA SHEET

Gas ranges with ES 330 electronic oven control (some models with cooktop lockout)

NOTICE - This service data sheet is intended for use by persons having electrical and mechanical training and a level of knowledge of these subjects generally considered acceptable in the appliance repair trade. The manufacturer cannot be responsible, nor assume any liability for injury or damage of any kind arising from the use of this data sheet.

SAFE SERVICING PRACTICES

To avoid the possibility of personal injury and/or property damage, it is important that safe servicing practices be observed. The following are examples, but without limitation, of such practices.

- Before servicing or moving an appliance remove power cord from electrical outlet, trip circuit breaker to OFF, or remove fuse.
- Never interfere with the proper installation of any safety device.
- GROUNDING:** The standard color coding for safety ground wires is **GREEN** or **GREEN WITH YELLOW STRIPES**. Ground leads are not to be used as current carrying conductors. **It is extremely important that the service technician reestablish all safety grounds prior to completion of service. Failure to do so will create a potential safety hazard.**
- Prior to returning the product to service, ensure that:
 - All electric connections are correct and secure.
 - All electrical leads are properly dressed and secured away from sharp edges, high-temperature components, and moving parts.
 - All uninsulated electrical terminals, connectors, heaters, etc. are adequately spaced away from all metal parts and panels.
 - All safety grounds (both internal and external) are correctly and securely reassembled.

OVEN CALIBRATION

Set the electronic oven control for normal baking at 350°F. Obtain an average oven temperature after a minimum of 5 cycles. Press **Stop/ Clear** or **Cancel** to end bake mode.

E.O.C. CONTROL CONNECTIONS

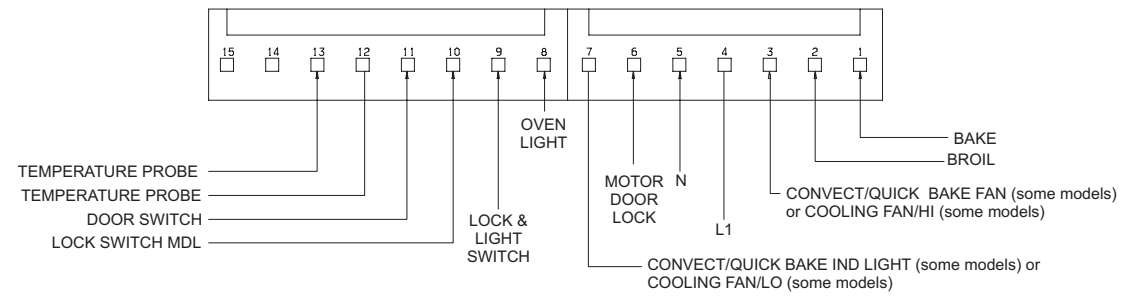

P8 CONNECTIONS (some models)

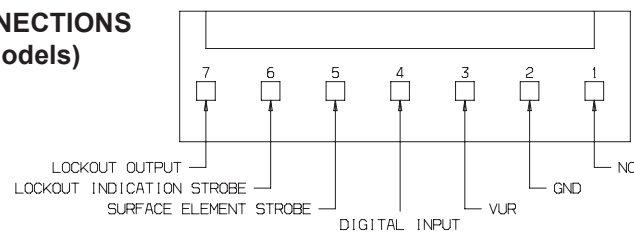

TEMPERATURE ADJUSTMENT

- Set EOC to bake at 550°F.
- Within 5 seconds of setting 550°F, press and hold the bake pad for approximately 15 seconds until a single beep is heard (longer may cause F11 shorted keypad alarm).
- Calibration offset should appear in the display.
- Use the slew keys to adjust the oven temperature up or down 35°F in 5°F increments.
- Once the desired (-35° to 35°) offset has been applied, press **Press Stop/ Clear** or **Cancel**.

Note: Changing calibration affects normal Bake mode. The adjustments made will not change the Self-Cleaning cycle temperature.

COOKTOP LOCKOUT (some models)

For some models it may be necessary to unlock the cooktop before servicing. If the Cooktop Locked Indicator Light is ON then the cooktop has been locked.

To turn the Cooktop Lockout Feature OFF:

- BE SURE ALL GAS SURFACE BURNER CONTROLS ARE SET TO THE OFF POSITION.**

2. Press & hold  until one beep is heard (after 3 seconds). The Cooktop

Locked indicator light will turn OFF and the gas surface burners may be used normally.

To turn the Cooktop Lockout Feature ON:

- BE SURE ALL GAS SURFACE BURNER CONTROLS ARE SET TO THE OFF POSITION.**

2. Press & hold  until one beep is heard (after 3 seconds). The Cooktop

Locked indicator light will turn ON and the gas surface burners and functions are locked out until the cooktop is unlocked.

RESISTANCE TEMPERATURE DETECTOR

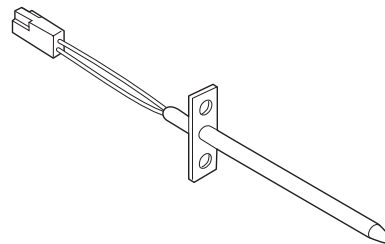

RTD TABLE

RTD SCALE	
Temperature (°F)	Resistance (ohms)
32 ± 1.9	1000 ± 4.0
75 ± 2.5	1091 ± 5.3
250 ± 4.4	1453 ± 8.9
350 ± 5.4	1654 ± 10.8
450 ± 6.9	1852 ± 13.5
550 ± 8.2	2047 ± 15.8
650 ± 9.6	2237 ± 18.5
900 ± 13.6	2697 ± 24.4

ELECTRONIC OVEN CONTROL (E.O.C. Rear View)

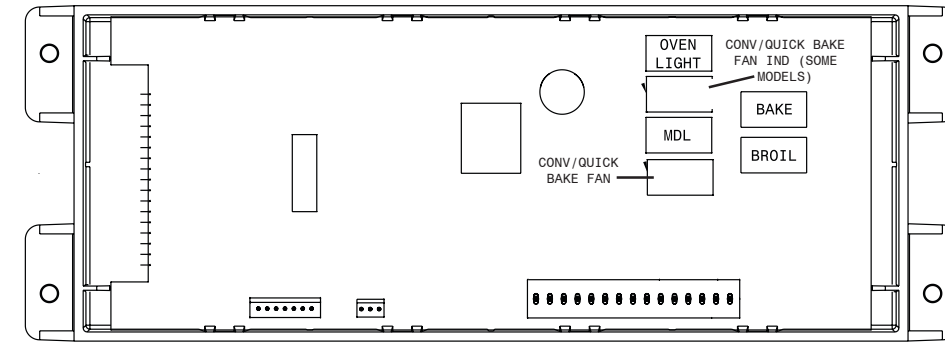

COOKTOP LOCKOUT CONTROL BOARD (some models)

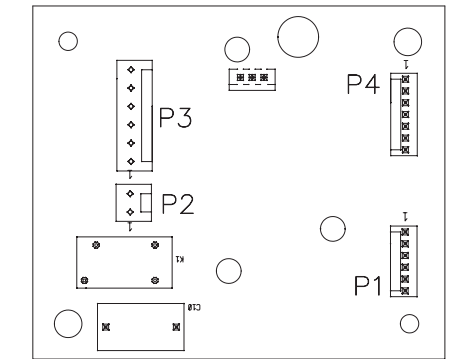

ELECTRONIC OVEN CONTROL FAULT CODE DESCRIPTIONS

Fault Code	Likely Failure Condition/Cause	Suggested Corrective Action
F10	Runaway Temperature.	1. (F10 only) Check RTD Sensor Probe & harness. Replace if necessary. If oven is overheating, disconnect power. If oven continues to overheat when the power is reapplied, replace EOC. Severe overheating may require the entire oven to be replaced should damage be extensive.
F11	Shorted Keypad.	2. (F11, 12 & 13) Disconnect power, wait 30 seconds and reapply power.
F12	Bad Micro Identification.	3. (F11, 12 & 13) If fault returns upon power-up, replace EOC.
F13	Bad EEPROM Identification/Checksum error.	
F30	Open probe circuit.	1. (F30 or F31) Check resistance at room temperature & compare to RTD Sensor resistance chart. If resistance does not match the RTD chart replace RTD Sensor Probe. Check Sensor wiring harness between EOC & Sensor Probe connector.
F31	Shorted Probe circuit.	2. (F30 or F31) Check resistance at room temperature, if less than 500 ohms, replace RTD Sensor Probe. Check for open or shorted Sensor Probe harness between EOC & Probe connector.
F40 (some models)	Cooktop Lockout Error. Cooktop lockout motor failed to lock or unlock the valve. NOTE: The valve lockout motor is very quiet. Under normal conditions the motor can not be heard when it is running.	IF VALVE LOCKOUT MOTOR RUNS: 1. Test valve lock microswitch. If defective replace valve assembly 2. Test harness from valve lock microswitch to Cooktop Lockout Board and from Board to EOC. Repair / Replace if defective 3. Replace Cooktop Lockout Board 4. Replace EOC IF VALVE LOCKOUT MOTOR DOES NOT RUN: 1. Test valve lock motor windings. If open replace valve assembly 2. Test for line voltage to valve lock motor. If voltage is correct replace valve assembly. 3. Test harness from Cooktop Lockout Board to valve lock motor and from Cooktop Lockout Board to EOC. Repair / Replace if defective. 4. Replace Cooktop Lockout Board. 5. Replace EOC.
F90	Maximum oven door unlock time exceeded.	IF LATCH MOTOR RUNS: 1. (F90, 91, 92, 93 & 94) Check the wiring between EOC & Lock Motor Micro Switch.
F91	Maximum oven door unlock attempts exceeded.	2. (F90, 91, 92, 93 & 94) Check the contacts of Micro-Switch on latch motor assembly. If contacts are open when motor cam depresses switch, replace Lock Motor Assembly.
F92	Maximum oven door open time exceeded.	3. (F90, 91, 92, 93 & 94) Check for binding of the Latch Cam, Lock Motor Rod & Lock Motor Cam.
F93	Maximum oven door lock time exceeded.	4. If all situations above do not solve problem, replace EOC.
F94	Maximum oven door lock attempts exceeded.	IF LATCH MOTOR DOES NOT RUN 1. (F90, 91, 92, 93 & 94) Check to see if Lock Motor Coil is open. If open, replace Lock Motor Assembly. 2. (F92, 93 & 94) Check oven door Light Switch - if open, replace Switch. 3. If all situations above do not solve problem, replace EOC.

CIRCUIT ANALYSIS MATRIX

	EOC Relays					Door Switch COM-NO	Warmer Drawer Lock Switch (Motor Door Latch)	Cooktop Lockout
	L1 to Bake	L1 to Broil	L1 to Motor Door Latch	L1 to Conv/Speed Bake Fan	L1 to Conv/Speed Bake Indicator Light			
Bake/Time Bake	X	X*					X	
Conv/Speed Bake	X	X*		X	X		X	
Broil		X					X	
Clean	X							
Unlocked							X	
Locking			X				X	
Locked								
Unlocking			X				X	
Door Open								
Door Closed						X		
Cooktop Active**								X

Note: X=Check listed circuits. *=Alternates with Bake element. **= some models.

IMPORTANT
DO NOT REMOVE THIS BAG
OR DESTROY THE CONTENTS
WIRING DIAGRAMS AND SERVICE
INFORMATION ENCLOSED
REPLACE CONTENTS IN BAG

GENERAL TROUBLESHOOTING DIAGRAM

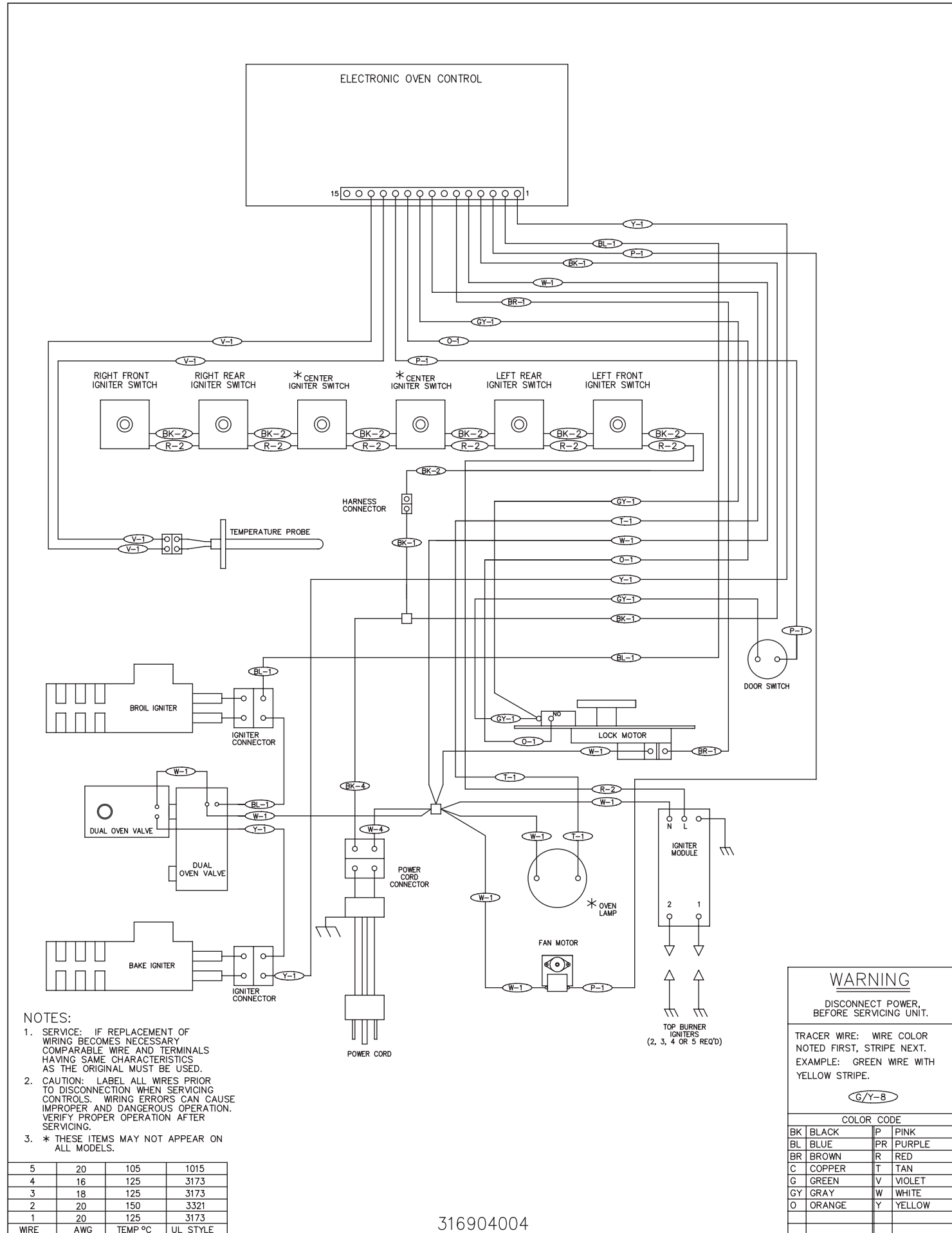

WARNING
DISCONNECT POWER, BEFORE SERVICING UNIT.

TRACER WIRE: WIRE COLOR NOTED FIRST, STRIPE NEXT. EXAMPLE: GREEN WIRE WITH YELLOW STRIPE.

G/Y-8

COLOR CODE			
BK	BLACK	P	PINK
BL	BLUE	PR	PURPLE
BR	BROWN	R	RED
C	COPPER	T	TAN
G	GREEN	V	VIOLET
GY	GRAY	W	WHITE
O	ORANGE	Y	YELLOW

GENERAL TROUBLESHOOTING SCHEMATIC

