

90±1

86±1

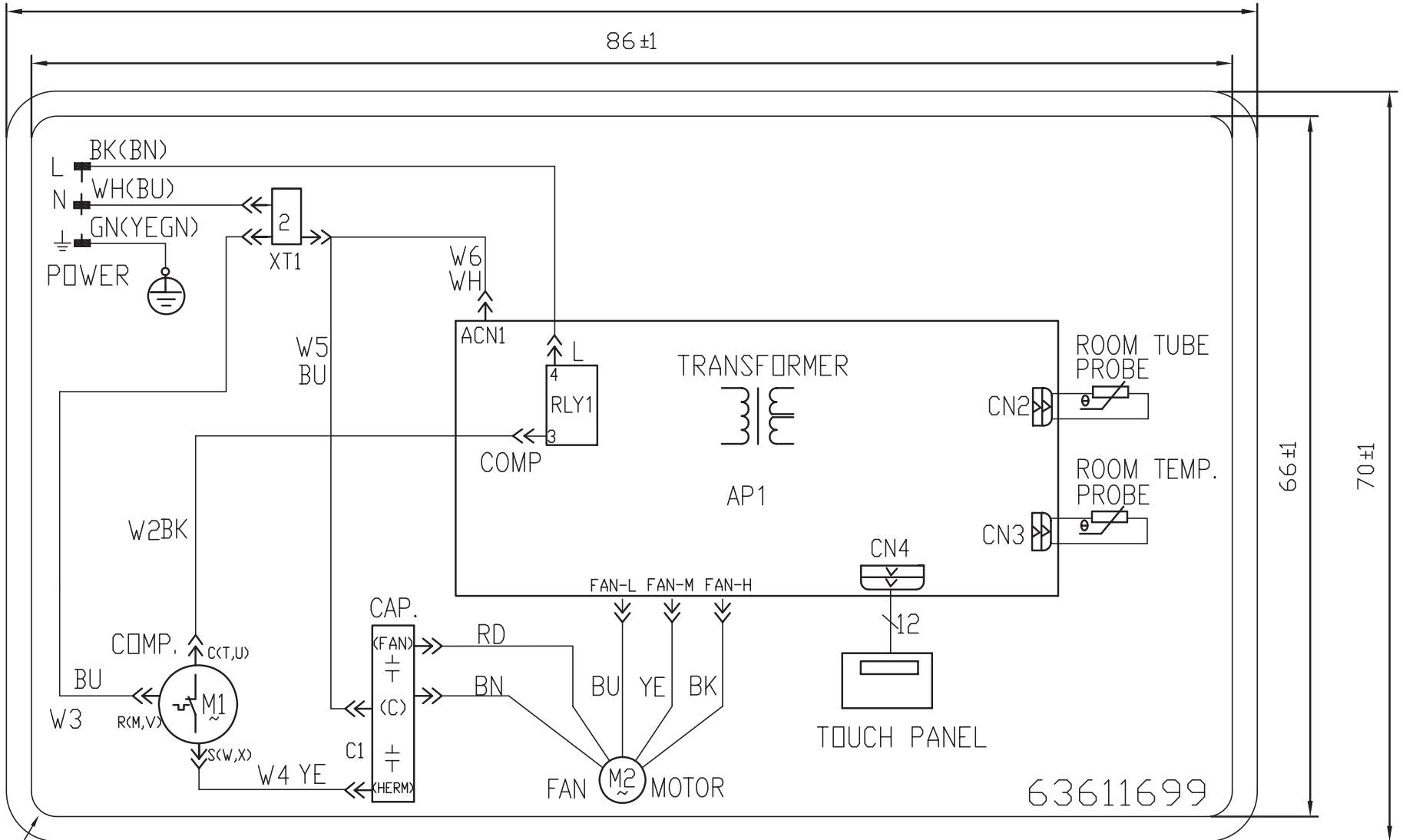

66±1

70±1

63611699

4-R2

4-R4