

# SUB-ZERO DESIGN GUIDE





## CONTENTS

Built-In Refrigeration	4
Integrated Refrigeration	31
Wine Storage	50
Undercounter Refrigeration	67
Warranty	77

*Features and specifications indicated herein and on our website are subject to change at any time without notice. Check our website, [subzero.com](http://subzero.com), for the most up-to-date specifications.*

## WELCOME TO SUB-ZERO

We make the ultimate built-in, integrated and undercounter refrigerators, freezers and wine storage units. We offer more solutions to your daily design problems of trying to work the largest appliance into a home without being obtrusive. Placing refrigeration in the home is no longer a problem, but, rather, an opportunity to exercise your creativity.

Sub-Zero has rethought traditional built-in refrigeration, a category it pioneered, with over 60 years of experience. When our complete line of configurations—all refrigerator and all freezer, over-and-under, or side-by-side—are coupled with three design alternatives and classic, platinum and carbon stainless steel finishes, the result is unlimited flexibility in satisfying your client's needs for residential refrigeration.

Created to blend invisibly into your home's decor, the Integrated line lets you incorporate refrigeration anywhere in the house—the kitchen, master suite, media room or workout room. These tall units or two-drawer base refrigerators, freezers and combination units can be hidden inside the furniture or cabinetry of your choosing.

Sub-Zero is breaking with conventional ways of offering Wine Storage for designers and their clients. Our Built-In and Integrated models, along with the free-standing Model 424FS, offer unlimited design and storage capabilities.

Our reputation is legendary. We have engineered and manufactured the best products in the business, and we stand behind our products with an unsurpassed warranty and a network of technicians to help you if service is necessary. See details of our warranty at the end of this guide.

Comprehensive installation instructions are shipped with each model. Refer to those instructions in preparing and installing all Sub-Zero products. These instructions along with product specifications and downloadable 2D and 3D CAD files, as well as pdf files can be found on our website, [subzero.com](http://subzero.com).

## CONTACT INFORMATION

**Sub-Zero Customer Service:**  
**800-222-7820**

**Website:**  
**[subzero.com](http://subzero.com)**

## IMPORTANT NOTE

As you follow these instructions, you will notice warning and caution symbols. This blocked information is important for the safe and efficient installation of Sub-Zero equipment. There are two types of potential hazards that may occur during installation.

### **⚠ CAUTION**

signals a situation where minor injury or product damage may occur if you do not follow instructions.

### **⚠ WARNING**

states a hazard that may cause serious injury or death if precautions are not followed.

Another footnote we would like to identify is IMPORTANT NOTE: This highlights information that is especially relevant to a problem-free installation.



**BUILT-IN REFRIGERATION**

Sub-Zero’s Built-In line offers you the most complete set of design options in built-in refrigeration for all of its models, from the classic look of the framed unit to the beauty of the overlay models and the professional treatment of the wrapped stainless steel doors.

Aside from the classic stainless steel, Sub-Zero offers platinum and carbon premium stainless steel finishes on its Built-In models and many related accessories. The only exception to these design alternatives are Models 648PRO and 648PROG, which are offered only in the classic stainless steel design application. In addition, Models 685 and 695 are offered in framed, overlay and classic stainless steel (not platinum or carbon).

Glass doors are available on our Models 601R, 611 and 650. They each come in a framed, overlay and stainless steel design. They all meet stringent Department of Energy standards. Model 648PROG also features a glass door in its classic stainless steel look.

In the illustrations, we have shown the three different design configurations of the framed, overlay and stainless steel units applied to Model 695. Please note how we qualify the different looks with the model number.

The traditional framed units come with an elegant full-length handle and an 11" (279) louvered grille.

Overlay models will come with no handle hardware, because the beauty of this design is that you can match the surrounding cabinetry hardware; however, we do offer optional handles as sales accessories. The new ice and water dispensing Models 685 and 695 are able to accept overlay panels. Overlay models will come with a standard 11" (279) panel grille that will accept decorative panel inserts. Models 601R, 601RG and 601F are only available with the louvered grille. No panel grille option is available.

All stainless steel models, with the exception of those mentioned earlier, are offered in the classic stainless steel finish and in the premium finishes of platinum and carbon. Stainless steel models come with a standard 11" (279) heavy-duty grille, 1" (25) diameter stainless steel handles and a stainless steel kickplate.

All grilles will be offered as options in 1" (25) increments from 10" (254) to 15" (381) and can be ordered as sales accessories. Models 601R, 601RG, 601F, 648PRO and 648PROG are the exception and are available only with an 11" (279) grille.

An important step in assuring a successful plan is to make sure that the actual equipment shipped to your installation site matches the design you have ordered. Each of these three design options—framed, overlay and stainless steel—has specific installation requirements, which means it is vital that the unit match your planning and space needs.

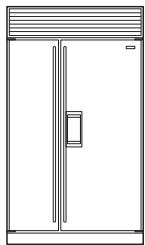

**Model 695/F  
Framed**

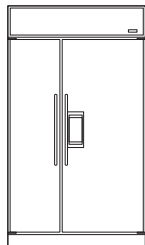

**Model 695/O  
Overlay**

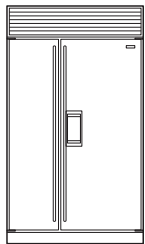

**Model 695/S  
Classic  
Stainless Steel**

Dimensions in parentheses are in millimeters unless otherwise specified.



**BUILT-IN REFRIGERATION**

These illustrations represent the full line of Sub-Zero Built-In models shown in the stainless steel design application with heavy-duty grille. Models 648PRO and 648PROG are available as built-in or free-standing units in classic stainless steel only.

For information regarding specific Built-In models, refer to the illustrations in this section. Regardless of the specific design application, framed, overlay or stainless steel, the interior specifications of each model are identical.

**ALL REFRIGERATOR | ALL FREEZER**

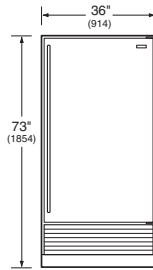

**MODEL 601R\***  
All Refrigerator  
Energy Star  
Qualified

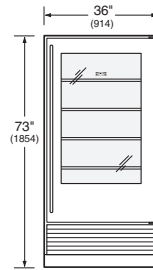

**MODEL 601RG\***  
All Refrigerator  
with Glass Door  
Energy Star  
Qualified

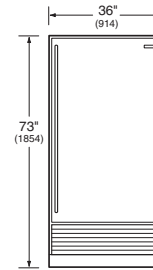

**MODEL 601F\***  
All Freezer

**OVER-AND-UNDER**



With the installation of a harness kit, these appliances are Star-K compliant to meet strict religious regulations in conjunction with specific instructions found on [www.star-k.org](http://www.star-k.org). Models 648PRO and 648PROG are Star-K certified from the factory with no extra wiring harness required. For details about the harness kit, contact your Sub-Zero dealer.

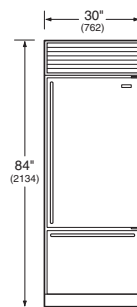

**MODEL 611\***  
Energy Star  
Qualified

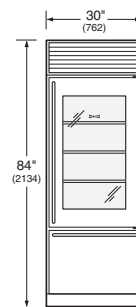

**MODEL 611G\***  
with Glass Door

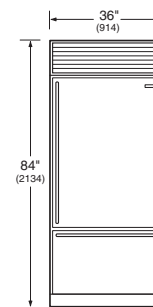

**MODEL 650\***  
Energy Star  
Qualified

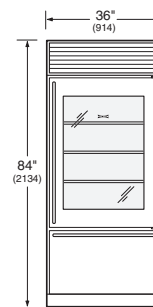

**MODEL 650G\***  
with Glass Door

**SIDE-BY-SIDE**

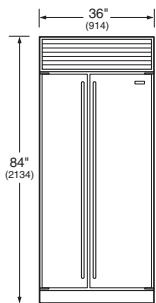

**MODEL 661\***

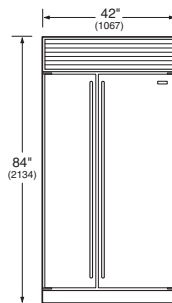

**MODEL 642\***

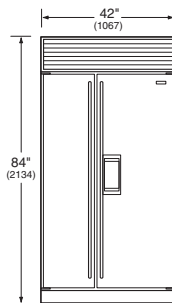

**MODEL 685\***  
Ice / Water  
Dispensing

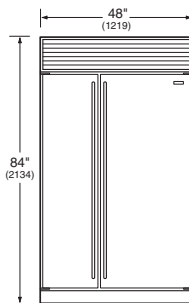

**MODEL 632\***

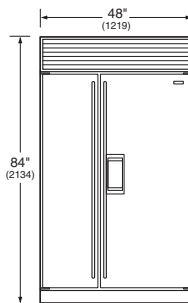

**MODEL 695\***  
Ice / Water  
Dispensing

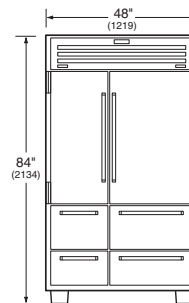

**MODEL 648PRO**  
Free-Standing  
or Built-In

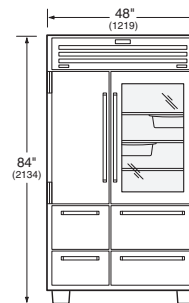

**MODEL 648PROG**  
Free-Standing  
or Built-In

\*Verify availability with your local dealer or distributor.

Comprehensive installation instructions are shipped with each model. Refer to those instructions in preparing and installing all Sub-Zero products. The instructions can also be found on our website, [subzero.com](http://subzero.com).



## BUILT-IN FEATURES

**Framed** models—the classic look that made Sub-Zero famous—feature a louvered grille and elegant full-length handle. An optional panel grille is available for framed units, except for Models 601R, 601RG and 601F. Optional panel conversion kits are available for the new ice and water dispensing Models 685 and 695.

**Overlay** models blend seamlessly into your overall room design and complement surrounding cabinetry. You add decorative hardware. Overlay models come with a panel grille that will accept decorative panel inserts. The new ice and water dispensing Models 685 and 695 are also available in the overlay application.

**Stainless steel** models feature wrapped doors, 1" (25) diameter stainless steel handles and a heavy-duty grille designed specifically to enhance the aesthetics of today's professional looking kitchens. All Built-In stainless steel models are offered in the classic stainless steel finish and in the premium finishes of platinum and carbon, except for Models 685, 695, 648PRO and 648PROG, which are offered in classic stainless steel only. The premium finishes are treated as special orders and must be ordered 90 days before you expect delivery.

**Dual Refrigeration System.** All Built-In combination models have the Sub-Zero dual refrigeration system, which ensures the freshest food and energy efficiency at the same time. You have precise independent control of the refrigerator and freezer compartments. In addition to two compressors, the PRO 48 has three separate evaporators to keep foods fresher longer and prevent odor transfer.

**Glass Door.** Model 601RG is an all refrigerator unit featuring a glass door. Models 611G and 650G are over-and-under combination units with a glass door on the refrigerator. These glass door models come in framed, overlay and stainless steel designs and meet stringent Department of Energy standards. The side-by-side Model 648PROG features a glass door on the refrigerator side and comes in classic stainless steel only.

**Stainless Steel.** The PRO 48 (Models 648PRO and 648PROG) feature stainless steel construction inside and out with classic finish for professional strength and beauty.

**Ice and Water Dispensing.** Models 685 and 695 feature a dispenser that gives you both ice and chilled water through the refrigerator door.

**Built-In Design.** True cabinet depth design means every inch of the interior is easy to reach. The PRO 48 can be built in or, with the free-standing accessory kit, used in a free-standing application.

**Fresh Food.** High-humidity crisper drawer with removable dividers is large and deep, with smooth sides for easy cleaning. The top refrigerated drawer on the PRO 48 features a tight-seal, retracting glass crisper lid that keeps produce exceptionally humid and fresh.

**Electronic Controls.** Up-front touch controls give you digital readings for quick, easy-to-read reference. The microprocessor provides supreme control, accurate to within one degree of preset temperatures, automatic defrosting that senses, then adapts to your use patterns, and a service indicator light. The PRO 48 also features exterior temperature displays.

**Advanced Lighting.** Bright lighting spreads even illumination throughout the compartment. The source of the illumination is concealed. The PRO 48 top LED lights bathe upper compartments in a soft glow. On the refrigerator side, channeled sidewall LEDs can even serve as a door-area night-light for Model 648PROG.

**Adjustable Shelves.** Cantilevered glass shelves make repositioning quick and easy. They are easy to clean, spill proof and steel reinforced for durability. The PRO 48 features glass shelves with stainless steel trim in the refrigerator and 100% stainless steel shelves in the freezer.

**Slide-Out Bins.** An exclusive PRO 48 feature—these versatile stainless steel bins hold small items, remove easily, and fit neatly under any shelf.

**Door Shelves.** All door shelves are adjustable for complete flexibility and convenience.

**Dairy Storage.** Dairy compartment is adjustable, with easy, one-door access, compartment dividers and a clean design. The dairy shelf is magnetically sealed to maintain freshness.

**Automatic Ice.** Ice maker provides high-quality, crescent-shaped ice that won't stick to the side of the glass. The PRO 48 features a water filter located just behind the easy-access pop-up grille, for ice as pure as it is fresh.

**Energy Efficient.** Our solid core doors improve insulation and structural integrity and help us exceed tough Department of Energy standards. Magnetic gaskets around all doors give extra-tight seals.

**Kickplate.** Solid, adjustable kickplate gives a true built-in look and conforms to American Institute of Architects standards.

SUB-ZERO  
WARRANTY

Sub-Zero products are covered by a two, five and twelve year residential warranty (exclusions apply). See warranty details at the end of this guide.

Dimensions in parentheses are in millimeters unless otherwise specified.



**MODEL 601R**

ALL REFRIGERATOR

*Energy Star Qualified*

**MODEL OPTIONS**

Framed Design	<b>601R/F</b>
Overlay Design	<b>601R/O</b>
Classic Stainless Steel	<b>601R/S</b>
Platinum Stainless Steel	<b>601R/P</b>
Carbon Stainless Steel	<b>601R/B</b>

**SPECIFICATIONS**

Overall Width	<b>36" (914)</b>
Overall Height	<b>73" (1854)</b>
Overall Depth	<b>24" (610)</b>
Refrigerator Capacity	<b>19.9 cu ft (564 L)</b>
Min Height Required	<b>72<sup>3</sup>/<sub>4</sub>" (1848)</b>
Door Swing Clearance	<b>36<sup>1</sup>/<sub>16</sub>" (916)</b>
Specify Door Swing	<b>LH or RH</b>
Annual Energy Usage	<b>399 kWh   \$37*</b>
Shipping Wt (F)	<b>391 lbs (177 kg)</b>
Shipping Wt (O)	<b>391 lbs (177 kg)</b>
Shipping Wt (S/P/B)	<b>420 lbs (191 kg)</b>

**REFRIGERATOR FEATURES**

- 4 Adjustable Glass Shelves
- 1 Stationary Glass Shelf
- High-Humidity Compartment with Dividers
- Adjustable Roll-Out Deli Basket
- 3 Adjustable Door Shelves
- Adjustable Dairy Compartment
- Egg Container

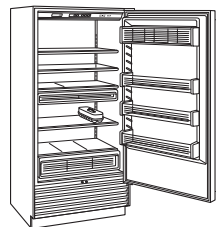

**MODEL 601R**

*Verify availability with your local dealer or distributor.*

*\*Annual energy costs are based on 9.06 cents per kilowatt hour.*

*\*\*High altitude glass doors are for installations at or above 5,000' (1524 m) in elevation and will be treated as a special order. Please allow 90 days for delivery. When ordering, add an (HA) before the (G) to obtain the correct model number.*

*All models are shown in the stainless steel design application.*

**MODEL 601RG**

ALL REFRIGERATOR WITH GLASS DOOR

*Energy Star Qualified*

**MODEL OPTIONS**

Framed Design	<b>601RG/F</b>
Overlay Design	<b>601RG/O</b>
Classic Stainless Steel	<b>601RG/S</b>
Platinum Stainless Steel	<b>601RG/P</b>
Carbon Stainless Steel	<b>601RG/B</b>

**SPECIFICATIONS**

Overall Width	<b>36" (914)</b>
Overall Height	<b>73" (1854)</b>
Overall Depth	<b>24" (610)</b>
Refrigerator Capacity	<b>20.1 cu ft (569 L)</b>
Min Height Required	<b>72<sup>3</sup>/<sub>4</sub>" (1848)</b>
Door Swing Clearance	<b>36<sup>1</sup>/<sub>16</sub>" (916)</b>
Specify Door Swing	<b>LH or RH</b>
Annual Energy Usage	<b>400 kWh   \$37*</b>
Shipping Wt (F)	<b>400 lbs (181 kg)</b>
Shipping Wt (O)	<b>400 lbs (181 kg)</b>
Shipping Wt (S/P/B)	<b>430 lbs (195 kg)</b>

**REFRIGERATOR FEATURES**

- 4 Adjustable Glass Shelves
- 1 Stationary Glass Shelf
- High-Humidity Compartment with Dividers
- Triple-Pane UV Resistant Glass Door
- Optional Accessory Roll-Out Deli Basket Available
- Egg Container
- Optional High Altitude Glass Available\*\*

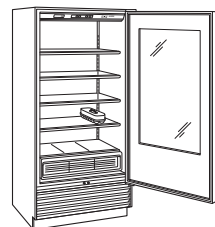

**MODEL 601RG**

**ACCESSORIES**  
*Contact your Sub-Zero Dealer*

**Front panels for framed design in white enamel and classic stainless steel—not available for glass door models**

**Side panels in white enamel and classic stainless steel**

**Extended framed handles**

**MODEL 601F**

ALL FREEZER

**MODEL OPTIONS**

Framed Design	<b>601F/F</b>
Overlay Design	<b>601F/O</b>
Classic Stainless Steel	<b>601F/S</b>
Platinum Stainless Steel	<b>601F/P</b>
Carbon Stainless Steel	<b>601F/B</b>

**SPECIFICATIONS**

Overall Width	<b>36" (914)</b>
Overall Height	<b>73" (1854)</b>
Overall Depth	<b>24" (610)</b>
Freezer Capacity	<b>19.3 cu ft (547 L)</b>
Min Height Required	<b>72<sup>3</sup>/<sub>4</sub>" (1848)</b>
Door Swing Clearance	<b>36<sup>1</sup>/<sub>16</sub>" (916)</b>
Specify Door Swing	<b>LH or RH</b>
Annual Energy Usage	<b>737 kWh   \$67*</b>
Shipping Wt (F)	<b>378 lbs (171 kg)</b>
Shipping Wt (O)	<b>378 lbs (171 kg)</b>
Shipping Wt (S/P/B)	<b>406 lbs (184 kg)</b>

**FREEZER FEATURES**

- Automatic Ice Maker
- 3 Adjustable Wire Shelves
- 1 Stationary Glass Shelf
- 3 Freezer Storage Drawers
- 5 Adjustable Door Shelves

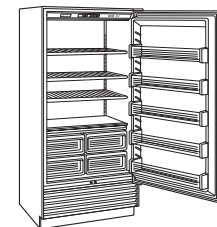

**MODEL 601F**

**Decorative overlay handles**

**90° and 105° door stop kits**

**Roll-out deli basket (Model 601RG)**

**Dozen egg container with lid**

**Harness kit for Star-K compliance**



**MODEL 611**

OVER-AND-UNDER

*Energy Star Qualified*

Verify availability with your local dealer or distributor.

\*Annual energy costs are based on 9.06 cents per kilowatt hour.

\*\*High altitude glass doors are for installations at or above 5,000' (1524 m) in elevation and will be treated as a special order. Please allow 90 days for delivery. When ordering, add an (HA) before the (G) to obtain the correct model number.

All models are shown in the stainless steel design application.

**MODEL OPTIONS**

Framed Design	<b>611/F</b>
Overlay Design	<b>611/O</b>
Classic Stainless Steel	<b>611/S</b>
Platinum Stainless Steel	<b>611/P</b>
Carbon Stainless Steel	<b>611/B</b>

**SPECIFICATIONS**

Overall Width	<b>30" (762)</b>
Overall Height	<b>84" (2134)</b>
Overall Depth	<b>24" (610)</b>
Refrigerator Capacity	<b>12.7 cu ft (360 L)</b>
Freezer Capacity	<b>3.9 cu ft (110 L)</b>
Min Height Required	<b>83" (2108)</b>
Door Swing Clearance	<b>30<sup>1</sup>/<sub>8</sub>" (765)</b>
Annual Energy Usage	<b>463 kWh   \$42*</b>
Shipping Wt (F)	<b>430 lbs (195 kg)</b>
Shipping Wt (O)	<b>430 lbs (195 kg)</b>
Shipping Wt (S/P/B)	<b>462 lbs (210 kg)</b>

**REFRIGERATOR (DOOR)**

- 3 Adjustable Glass Shelves
- 1 Stationary Glass Shelf
- High-Humidity Compartment with Divider
- Adjustable Roll-Out Deli Basket
- 2 Adjustable Door Shelves
- Adjustable Dairy Compartment
- Egg Container

**FREEZER (DRAWER)**

- Full-Extension Roll-Out Freezer Drawer
- Two-Tier Wire Storage Baskets
- Automatic Ice Maker

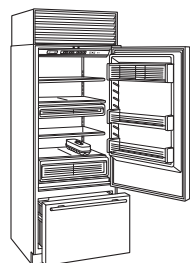

**MODEL 611**

**MODEL 611G**

OVER-AND-UNDER  
WITH GLASS DOOR

**MODEL OPTIONS**

Framed Design	<b>611G/F</b>
Overlay Design	<b>611G/O</b>
Classic Stainless Steel	<b>611G/S</b>
Platinum Stainless Steel	<b>611G/P</b>
Carbon Stainless Steel	<b>611G/B</b>

**SPECIFICATIONS**

Overall Width	<b>30" (762)</b>
Overall Height	<b>84" (2134)</b>
Overall Depth	<b>24" (610)</b>
Refrigerator Capacity	<b>12.9 cu ft (365 L)</b>
Freezer Capacity	<b>3.9 cu ft (110 L)</b>
Min Height Required	<b>83" (2108)</b>
Door Swing Clearance	<b>30<sup>1</sup>/<sub>8</sub>" (765)</b>
Annual Energy Usage	<b>544 kWh   \$50*</b>
Shipping Wt (F)	<b>471 lbs (214 kg)</b>
Shipping Wt (O)	<b>471 lbs (214 kg)</b>
Shipping Wt (S/P/B)	<b>476 lbs (216 kg)</b>

**REFRIGERATOR (DOOR)**

- 3 Adjustable Glass Shelves
- 1 Stationary Glass Shelf
- High-Humidity Compartment with Divider
- Triple-Pane UV Resistant Glass Door
- Optional Accessory Roll-Out Deli Basket Available
- Egg Container
- Optional High Altitude Glass Available\*\*

**FREEZER (DRAWER)**

- Full-Extension Roll-Out Freezer Drawer
- Two-Tier Wire Storage Baskets
- Automatic Ice Maker

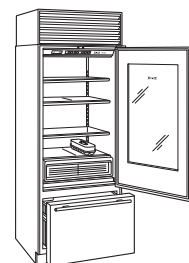

**MODEL 611G**

Dimensions in parentheses are in millimeters unless otherwise specified.





**MODEL 650**

OVER-AND-UNDER

*Energy Star Qualified*

**MODEL OPTIONS**

Framed Design	<b>650/F</b>
Overlay Design	<b>650/O</b>
Classic Stainless Steel	<b>650/S</b>
Platinum Stainless Steel	<b>650/P</b>
Carbon Stainless Steel	<b>650/B</b>

**SPECIFICATIONS**

Overall Width	<b>36" (914)</b>
Overall Height	<b>84" (2134)</b>
Overall Depth	<b>24" (610)</b>
Refrigerator Capacity	<b>15.7 cu ft (445 L)</b>
Freezer Capacity	<b>4.9 cu ft (139 L)</b>
Min Height Required	<b>83" (2108)</b>
Door Swing Clearance	<b>36<sup>1</sup>/<sub>16</sub>" (916)</b>
Annual Energy Usage	<b>481 kWh   \$44*</b>
Shipping Wt (F)	<b>482 lbs (219 kg)</b>
Shipping Wt (O)	<b>482 lbs (219 kg)</b>
Shipping Wt (S/P/B)	<b>515 lbs (234 kg)</b>

**REFRIGERATOR (DOOR)**

- 3** Adjustable Glass Shelves
- 1** Stationary Glass Shelf
- High-Humidity Compartment with Dividers
- Adjustable Roll-Out Deli Basket
- 2** Adjustable Door Shelves
- Adjustable Dairy Compartment
- Egg Container

**FREEZER (DRAWER)**

- Full-Extension Roll-Out Freezer Drawer
- Two-Tier Wire Storage Baskets
- Automatic Ice Maker

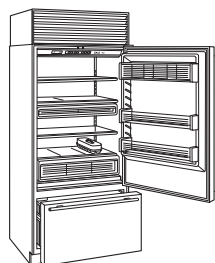

**MODEL 650**

**MODEL 650G**

OVER-AND-UNDER  
WITH GLASS DOOR

**MODEL OPTIONS**

Framed Design	<b>650G/F</b>
Overlay Design	<b>650G/O</b>
Classic Stainless Steel	<b>650G/S</b>
Platinum Stainless Steel	<b>650G/P</b>
Carbon Stainless Steel	<b>650G/B</b>

**SPECIFICATIONS**

Overall Width	<b>36" (914)</b>
Overall Height	<b>84" (2134)</b>
Overall Depth	<b>24" (610)</b>
Refrigerator Capacity	<b>16.0 cu ft (453 L)</b>
Freezer Capacity	<b>4.9 cu ft (139 L)</b>
Min Height Required	<b>83" (2108)</b>
Door Swing Clearance	<b>36<sup>1</sup>/<sub>16</sub>" (916)</b>
Annual Energy Usage	<b>565 kWh   \$52*</b>
Shipping Wt (F)	<b>523 lbs (237 kg)</b>
Shipping Wt (O)	<b>523 lbs (237 kg)</b>
Shipping Wt (S/P/B)	<b>529 lbs (240 kg)</b>

**REFRIGERATOR (DOOR)**

- 3** Adjustable Glass Shelves
- 1** Stationary Glass Shelf
- High-Humidity Compartment with Dividers
- Triple-Pane UV Resistant Glass Door
- Optional Accessory Roll-Out Deli Basket Available
- Egg Container
- Optional High Altitude Glass Available\*\*

**FREEZER (DRAWER)**

- Full-Extension Roll-Out Freezer Drawer
- Two-Tier Wire Storage Baskets
- Automatic Ice Maker

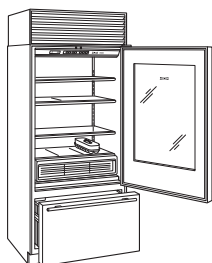

**MODEL 650G**

**ACCESSORIES**

Optional accessories are available through your Sub-Zero dealer. To obtain local dealer information, visit the Showroom Locator section of our website, [subzero.com](http://subzero.com).

**ACCESSORIES**

Contact your Sub-Zero Dealer

Front and grille panels for framed design in white enamel and classic stainless steel

Side panels in white enamel and classic stainless steel

Louvered, panel or stainless steel grilles in 1" (25) increments from 10" (254) to 15" (381) high

Extended framed handles

Decorative overlay handles

Roll-out deli basket (Models 611G and 650G)

Dozen egg container with lid

Harness kit for Star-K compliance



## BUILT-IN REFRIGERATION

### MODEL 661

SIDE-BY-SIDE

#### MODEL OPTIONS

Framed Design	<b>661/F</b>
Overlay Design	<b>661/O</b>
Classic Stainless Steel	<b>661/S</b>
Platinum Stainless Steel	<b>661/P</b>
Carbon Stainless Steel	<b>661/B</b>

#### SPECIFICATIONS

Overall Width	<b>36" (914)</b>
Overall Height	<b>84" (2134)</b>
Overall Depth	<b>24" (610)</b>
Refrigerator Capacity	<b>12.5 cu ft (354 L)</b>
Freezer Capacity	<b>8.8 cu ft (249 L)</b>
Min Height Required	<b>83" (2108)</b>
Door Swing Clearance	<b>20<sup>3</sup>/<sub>4</sub>" (527)</b>
Annual Energy Usage	<b>636 kWh   \$58*</b>
Shipping Wt (F)	<b>500 lbs (227 kg)</b>
Shipping Wt (O)	<b>500 lbs (227 kg)</b>
Shipping Wt (S/P/B)	<b>538 lbs (244 kg)</b>

#### REFRIGERATOR FEATURES

- 4 Adjustable Glass Shelves
- 1 Stationary Glass Shelf
- High-Humidity Compartment
- 1 Storage Drawer
- Adjustable Roll-Out Deli Basket
- 3 Adjustable Door Shelves
- Adjustable Dairy Compartment
- Egg Container

#### FREEZER FEATURES

- Automatic Ice Maker
- 2 Adjustable Wire Shelves
- 1 Stationary Solid Shelf
- 4 Storage Drawers
- 5 Adjustable Door Shelves

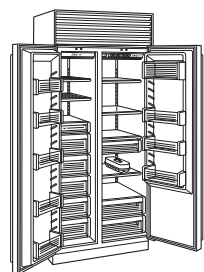

MODEL 661

### MODEL 642

SIDE-BY-SIDE

#### MODEL OPTIONS

Framed Design	<b>642/F</b>
Overlay Design	<b>642/O</b>
Classic Stainless Steel	<b>642/S</b>
Platinum Stainless Steel	<b>642/P</b>
Carbon Stainless Steel	<b>642/B</b>

#### SPECIFICATIONS

Overall Width	<b>42" (1067)</b>
Overall Height	<b>84" (2134)</b>
Overall Depth	<b>24" (610)</b>
Refrigerator Capacity	<b>16.2 cu ft (459 L)</b>
Freezer Capacity	<b>8.2 cu ft (232 L)</b>
Min Height Required	<b>83" (2108)</b>
Door Swing Clearance	<b>25<sup>9</sup>/<sub>16</sub>" (649)</b>
Annual Energy Usage	<b>650 kWh   \$59*</b>
Shipping Wt (F)	<b>541 lbs (245 kg)</b>
Shipping Wt (O)	<b>541 lbs (245 kg)</b>
Shipping Wt (S/P/B)	<b>582 lbs (264 kg)</b>

#### REFRIGERATOR FEATURES

- 4 Adjustable Glass Shelves
- 1 Stationary Glass Shelf
- High-Humidity Compartment
- 1 Storage Drawer
- Adjustable Roll-Out Deli Basket
- 3 Adjustable Door Shelves
- Adjustable Dairy Compartment
- Egg Container

#### FREEZER FEATURES

- Automatic Ice Maker
- 3 Adjustable Wire Shelves
- 1 Stationary Solid Shelf
- 3 Storage Drawers
- 5 Adjustable Door Shelves

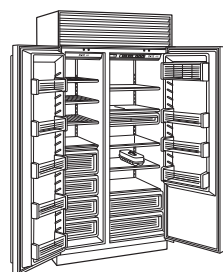

MODEL 642

### MODEL 685

SIDE-BY-SIDE  
ICE | WATER DISPENSING

#### MODEL OPTIONS

Framed Design	<b>685/F</b>
Overlay Design	<b>685/O</b>
Classic Stainless Steel	<b>685/S</b>

#### SPECIFICATIONS

Overall Width	<b>42" (1067)</b>
Overall Height	<b>84" (2134)</b>
Overall Depth	<b>24" (610)</b>
Refrigerator Capacity	<b>15.6 cu ft (442 L)</b>
Freezer Capacity	<b>8.2 cu ft (232 L)</b>
Min Height Required	<b>83" (2108)</b>
Door Swing Clearance	<b>25<sup>9</sup>/<sub>16</sub>" (649)</b>
Annual Energy Usage	<b>694 kWh   \$63*</b>
Shipping Wt (F)	<b>569 lbs (258 kg)</b>
Shipping Wt (O)	<b>569 lbs (258 kg)</b>
Shipping Wt (S)	<b>608 lbs (276 kg)</b>

#### REFRIGERATOR FEATURES

- 4 Adjustable Glass Shelves
- 1 Stationary Glass Shelf
- High-Humidity Compartment
- 1 Storage Drawer
- Adjustable Roll-Out Deli Basket
- 3 Adjustable Door Shelves
- Adjustable Dairy Compartment
- Egg Container

#### FREEZER FEATURES

- Automatic Ice Maker
- 2 Adjustable Wire Shelves
- 1 Stationary Wire Shelf
- 3 Storage Drawers
- 5 Adjustable Door Shelves
- 2 Juice Can Shelves

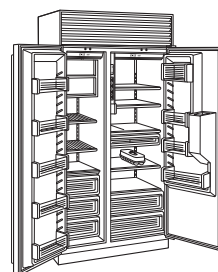

MODEL 685



**MODEL 632**

SIDE-BY-SIDE

**MODEL OPTIONS**

Framed Design	<b>632/F</b>
Overlay Design	<b>632/O</b>
Classic Stainless Steel	<b>632/S</b>
Platinum Stainless Steel	<b>632/P</b>
Carbon Stainless Steel	<b>632/B</b>

**SPECIFICATIONS**

Overall Width	<b>48" (1219)</b>
Overall Height	<b>84" (2134)</b>
Overall Depth	<b>24" (610)</b>
Refrigerator Capacity	<b>18.9 cu ft (535 L)</b>
Freezer Capacity	<b>9.8 cu ft (278 L)</b>
Min Height Required	<b>83" (2108)</b>
Door Swing Clearance	<b>29 1/4" (743)</b>
Annual Energy Usage	<b>675 kWh   \$62*</b>
Shipping Wt (F)	<b>582 lbs (264 kg)</b>
Shipping Wt (O)	<b>582 lbs (264 kg)</b>
Shipping Wt (S/P/B)	<b>630 lbs (286 kg)</b>

**REFRIGERATOR FEATURES**

- 4 Adjustable Glass Shelves
- 1 Stationary Glass Shelf
- High-Humidity Compartment with Divider
- 2 Storage Drawers
- Adjustable Roll-Out Deli Basket
- 3 Adjustable Door Shelves
- Adjustable Dairy Compartment
- Egg Container

**FREEZER FEATURES**

- Automatic Ice Maker
- 3 Adjustable Wire Shelves
- 1 Stationary Solid Shelf
- 3 Storage Drawers
- 5 Adjustable Door Shelves

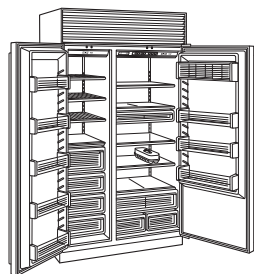

**MODEL 632**

**MODEL 695**

SIDE-BY-SIDE  
ICE | WATER DISPENSING

**MODEL OPTIONS**

Framed Design	<b>695/F</b>
Overlay Design	<b>695/O</b>
Classic Stainless Steel	<b>695/S</b>

**SPECIFICATIONS**

Overall Width	<b>48" (1219)</b>
Overall Height	<b>84" (2134)</b>
Overall Depth	<b>24" (610)</b>
Refrigerator Capacity	<b>18.2 cu ft (515 L)</b>
Freezer Capacity	<b>9.8 cu ft (278 L)</b>
Min Height Required	<b>83" (2108)</b>
Door Swing Clearance	<b>29 1/4" (743)</b>
Annual Energy Usage	<b>747 kWh   \$68*</b>
Shipping Wt (F)	<b>610 lbs (277 kg)</b>
Shipping Wt (O)	<b>610 lbs (277 kg)</b>
Shipping Wt (S)	<b>656 lbs (298 kg)</b>

**REFRIGERATOR FEATURES**

- 4 Adjustable Glass Shelves
- 1 Stationary Glass Shelf
- High-Humidity Compartment with Divider
- 2 Storage Drawers
- Adjustable Roll-Out Deli Basket
- 3 Adjustable Door Shelves
- Adjustable Dairy Compartment
- Egg Container

**FREEZER FEATURES**

- Automatic Ice Maker
- 2 Adjustable Wire Shelves
- 1 Stationary Wire Shelf
- 3 Storage Drawers
- 5 Adjustable Door Shelves
- 2 Juice Can Shelves

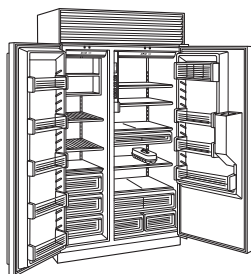

**MODEL 695**

Verify availability with your local dealer or distributor.

\*Annual energy costs are based on 9.06 cents per kilowatt hour.

All models are shown in the stainless steel design application.

**ACCESSORIES**

Contact your Sub-Zero Dealer

Front and grille panels for framed design in white enamel and classic stainless steel

Side panels in white enamel and classic stainless steel

Louvered, panel or stainless steel grilles in 1" (25) increments from 10" (254) to 15" (381) high

Framed panel kits (Models 685 and 695)\*

Extended framed handles

Decorative overlay handles

90° and 105° door stop kits

Dozen egg container with lid

Harness kit for Star-K compliance

\*Refer to page 19 for additional information.

Dimensions in parentheses are in millimeters unless otherwise specified.



## BUILT-IN REFRIGERATION

### MODEL 648PRO

SIDE-BY-SIDE  
BUILT-IN OR FREE-STANDING

*\*Annual energy costs are based on 9.06 cents per kilowatt hour.*

*\*\*High altitude glass doors are for installations at or above 5,000' (1524 m) in elevation and will be treated as a special order. Please allow 90 days for delivery. When ordering, add an (HA) before the (G) to obtain the correct model number.*

#### SPECIFICATIONS

Overall Width	<b>48" (1219)</b>
Overall Height	<b>84" (2134)</b>
Overall Depth	<b>25<sup>7</sup>/<sub>8</sub>" (657)</b>
Refrigerator Capacity	<b>18.4 cu ft (521 L)</b>
Freezer Capacity	<b>11.7 cu ft (331 L)</b>
Min Height Required	<b>83<sup>1</sup>/<sub>2</sub>" (2121)</b>
Door Swing Clearance	<b>28<sup>3</sup>/<sub>4</sub>" (730)</b>
Annual Energy Usage	<b>689 kWh   \$63*</b>
Shipping Weight	<b>860 lbs (390 kg)</b>

#### REFRIGERATOR

*(Door and Two Drawers)*

- 3 Adjustable Glass Shelves
- 1 Stationary Glass Shelf
- 2 Adjustable Slide-Out Stainless Steel Bins
- 1 Crisper Lid
- Dividers for Drawers Included

#### FREEZER

*(Door and Two Drawers)*

- Automatic Ice Maker
- Water Filtration Filter
- 3 Adjustable Stainless Steel Shelves
- 1 Stationary Stainless Steel Shelf
- 1 Stainless Steel Ice Bucket

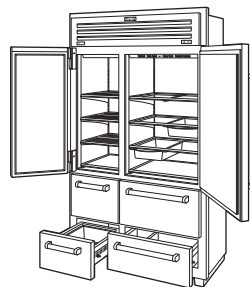

**MODEL 648PRO**

### MODEL 648PROG

SIDE-BY-SIDE  
WITH GLASS DOOR  
BUILT-IN OR FREE-STANDING

#### SPECIFICATIONS

Overall Width	<b>48" (1219)</b>
Overall Height	<b>84" (2134)</b>
Overall Depth	<b>25<sup>7</sup>/<sub>8</sub>" (657)</b>
Refrigerator Capacity	<b>18.4 cu ft (521 L)</b>
Freezer Capacity	<b>11.7 cu ft (331 L)</b>
Min Height Required	<b>83<sup>1</sup>/<sub>2</sub>" (2121)</b>
Door Swing Clearance	<b>28<sup>3</sup>/<sub>4</sub>" (730)</b>
Annual Energy Usage	<b>689 kWh   \$63*</b>
Shipping Weight	<b>875 lbs (397 kg)</b>

#### REFRIGERATOR

*(Door and Two Drawers)*

- 3 Adjustable Glass Shelves
- 1 Stationary Glass Shelf
- 2 Adjustable Slide-Out Stainless Steel Bins
- 1 Crisper Lid
- Dividers for Drawers Included
- Triple-Pane UV Resistant Glass Door
- Optional High Altitude Glass Available\*\*

#### FREEZER

*(Door and Two Drawers)*

- Automatic Ice Maker
- Water Filtration Filter
- 3 Adjustable Stainless Steel Shelves
- 1 Stationary Stainless Steel Shelf
- 1 Stainless Steel Ice Bucket



**MODEL 648PROG**

#### ACCESSORIES

Contact your Sub-Zero Dealer

90° door stop kit—right or left hinge

Dozen egg container with lid

Slide-out stainless steel refrigerator bin

Refrigerator drawer dividers

Classic stainless steel side panel

Free-standing kit—includes two stainless steel side panels and top lid

Dimensions in parentheses are in millimeters unless otherwise specified.



## PLANNING INFORMATION

Although the Sub-Zero Built-In line offers a wide range of designs and configurations, the basic planning considerations for all models have much in common. As you integrate Built-In models into your overall plan, review installation requirements for your particular model(s). The Installation Specifications illustrations provide planning information for all Built-In models—framed, overlay and stainless steel.

Allow the door(s) to open a minimum of 90° or you'll have problems removing drawers. With the door opening at 90°, you may have to move drawers slightly to clear the door interior.

For corner installations, allow for a minimum 3" (76) filler so that the door can open to 90°. If you're using raised panels, consider using a wider filler.

When units are installed side by side, a filler strip is recommended. The width of this filler strip will vary depending on the configuration and panels you use.

Be sure to add the filler strip width to your finished rough opening dimension. In any installation of two units side by side without a filler strip, add an additional 1/2" (13) to your combined numbers. This will allow for the proper width.

**IMPORTANT NOTE:** Refer to the full-scale illustrations at the end of this section for specifics on door openings and filler size alternatives.

## ELECTRICAL REQUIREMENTS

A 115 V AC, 60 Hz, 15 amp circuit breaker and electrical supply are required. A separate circuit, servicing only this appliance, is required.

All Sub-Zero Built-In models are equipped with a power supply cord with a 3-prong grounding plug, which must be plugged into a mating 3-prong grounding-type wall receptacle. Follow the National Electrical Code and local codes and ordinances when installing the receptacle. Refer to the Installation Specifications illustration for your model on the following pages.

**IMPORTANT NOTE:** A ground fault circuit interrupter (GFCI) is not recommended and may cause interruption of operation.

## PLUMBING CONSIDERATIONS

For Built-In models with an automatic ice maker, rough in the water supply line. Connect a 1/4" OD copper line to the house supply, being sure to use an easily accessible shut-off valve between the supply and the refrigerator.

Do not use self-piercing valves. A saddle valve kit (4200880) is available from your Sub-Zero dealer.

For Built-In models except Models 648PRO and 648PROG, a line filter is required when water conditions have a high sediment content. The ice maker operates on water pressure of 20 psi (1.4 bar) to 100 psi (6.9 bar).

**IMPORTANT NOTE:** In some cases a reverse osmosis water filter system may not be able to maintain the minimum water pressure consistently.

Models 648PRO and 648PROG come with an automatic ice maker and an integrated water filtration system. This system operates on water pressure between 35 psi (2.4 bar) and 120 psi (8.3 bar).

**IMPORTANT NOTE:** A reverse osmosis system can be used with Models 648PRO and 648PROG, provided there is constant water pressure of 20 psi (1.4 bar) to 120 psi (8.3 bar) supplied to the unit at all times. In this application, the integrated water filtration system must be set to bypass mode. This is achieved by removing the water filter cartridge. Refer to the PRO 48 Installation Instructions packed with the unit for detailed instructions.

The water line should be routed up through the floor within 1/2" (13) from the back wall and no higher than 3" (76) off the floor. If you have to come through the wall, make sure the water line is no more than 3" (76) from the floor.

Regardless of the routing, allow 3' (1 m) of excess copper tubing to remain outside the wall or floor for easy connection to the unit. Refer to Installation Specification illustrations.

## MODEL OPTIONS

**Model 601R**  
36" (914)  
*All Refrigerator*

**Model 601RG**  
36" (914)  
*All Refrigerator with Glass Door*

**Model 601F**  
36" (914)  
*All Freezer*

**Model 611**  
30" (762)  
*Over-and-Under*

**Model 611G**  
30" (762)  
*Over-and-Under with Glass Door*

**Model 650**  
36" (914)  
*Over-and-Under*

**Model 650G**  
36" (914)  
*Over-and-Under with Glass Door*

**Model 661**  
36" (914)  
*Side-by-Side*

**Model 642**  
42" (1067)  
*Side-by-Side*

**Model 685**  
42" (1067)  
*Side-by-Side Ice / Water Dispensing*

**Model 632**  
48" (1219)  
*Side-by-Side*

**Model 695**  
48" (1219)  
*Side-by-Side Ice / Water Dispensing*

**Model 648PRO**  
48" (1219)  
*Side-by-Side Built-In or Free-Standing*

**Model 648PROG**  
48" (1219)  
*Side-by-Side with Glass Door Built-In or Free-Standing*



# BUILT-IN REFRIGERATION

## OVERALL DIMENSIONS

All Refrigerator | All Freezer Models

ALL REFRIGERATOR  
ALL FREEZER

**Model 601R**  
All Refrigerator

**Model 601RG**  
All Refrigerator  
with Glass Door

**Model 601F**  
All Freezer

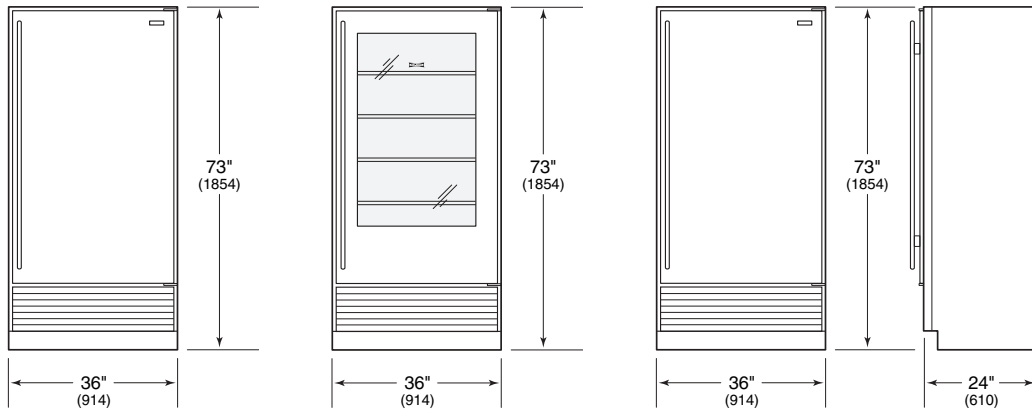

**Model 601R**  
All Refrigerator

Width **36" (914)**  
Height **73" (1854)**  
Depth **24" (610)**

**Model 601RG**  
All Refrigerator  
with Glass Door

Width **36" (914)**  
Height **73" (1854)**  
Depth **24" (610)**

**Model 601F**  
All Freezer

Width **36" (914)**  
Height **73" (1854)**  
Depth **24" (610)**

Illustrations shown in stainless steel design.

Refer to the full-scale illustrations at the end of this section for specifics on door openings and other specifications.

## INSTALLATION SPECIFICATIONS

All Refrigerator | All Freezer Models

Models 601R and 601RG, which do not have an ice maker, will not require the water line connection.

Dimensions are for finished rough openings.

Door swing clearances are based on stainless steel door and handle dimensions.

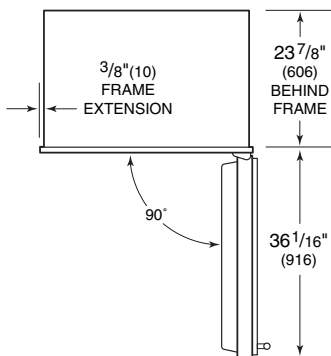

Dimensions in parentheses are in millimeters unless otherwise specified.

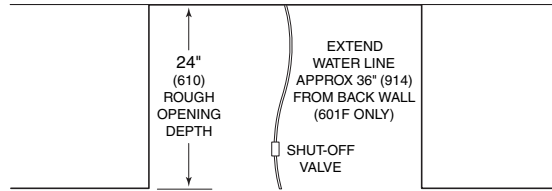

TOP VIEW

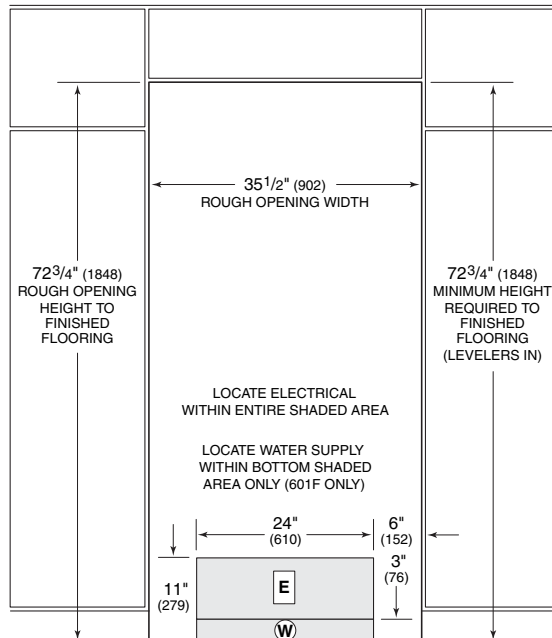

FRONT VIEW



OVERALL DIMENSIONS

Over-and-Under Refrigerator/Freezer Models

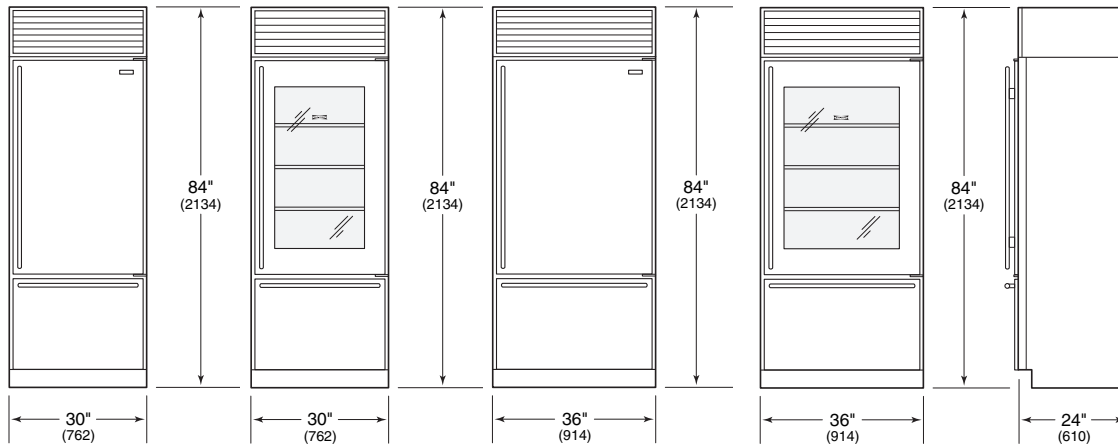

OVER-AND-UNDER

- Model 611
- Model 611G with Glass Door
- Model 650
- Model 650G with Glass Door

<b>Model 611</b>	<b>Model 611G</b> <i>with Glass Door</i>	<b>Model 650</b>	<b>Model 650G</b> <i>with Glass Door</i>
Width <b>30" (762)</b>	Width <b>30" (762)</b>	Width <b>36" (914)</b>	Width <b>36" (914)</b>
Height <b>84" (2134)</b>	Height <b>84" (2134)</b>	Height <b>84" (2134)</b>	Height <b>84" (2134)</b>
Depth <b>24" (610)</b>	Depth <b>24" (610)</b>	Depth <b>24" (610)</b>	Depth <b>24" (610)</b>

Illustrations shown in stainless steel design.

INSTALLATION SPECIFICATIONS  
Over-and-Under Refrigerator/Freezer Models

<b>Model 611</b>	
A) Rough Opening Width	<b>29 1/2" (749)</b>
B) Min Door Clearance	<b>30 1/8" (765)</b>
<b>Model 611G</b>	
A) Rough Opening Width	<b>29 1/2" (749)</b>
B) Min Door Clearance	<b>30 1/8" (765)</b>
<b>Model 650</b>	
A) Rough Opening Width	<b>35 1/2" (902)</b>
B) Min Door Clearance	<b>36 1/16" (916)</b>
<b>Model 650G</b>	
A) Rough Opening Width	<b>35 1/2" (902)</b>
B) Min Door Clearance	<b>36 1/16" (916)</b>

Dimensions are for finished rough openings.  
Door swing clearances are based on stainless steel door and handle dimensions.

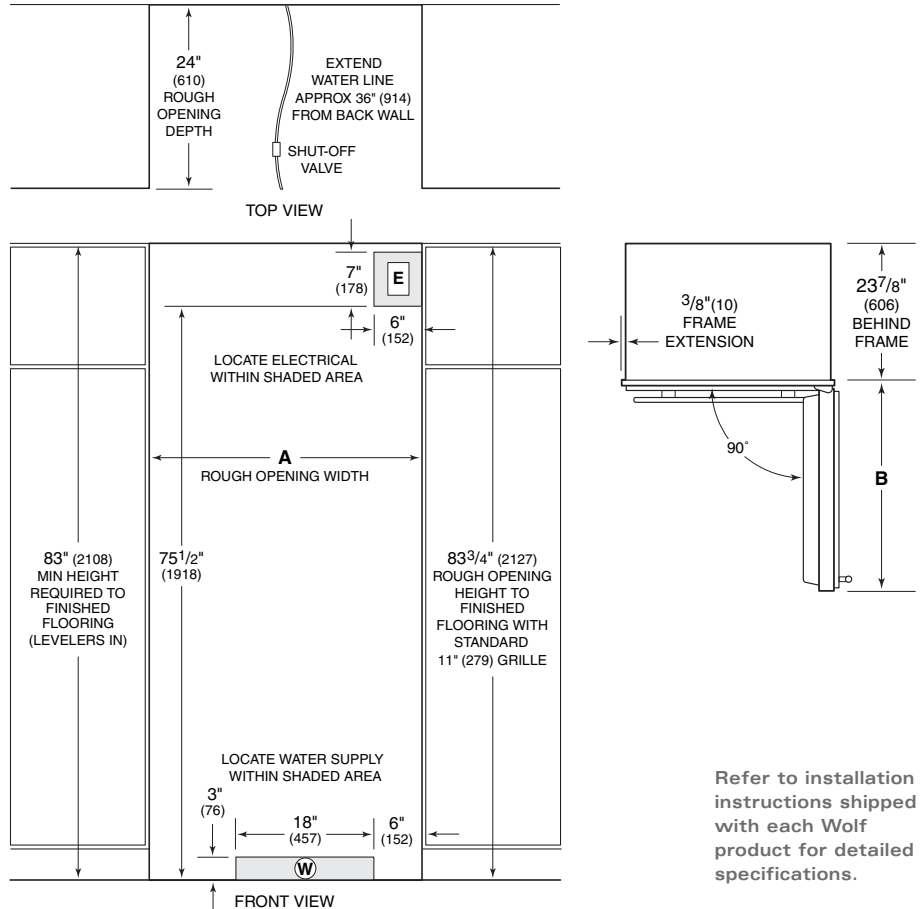

Refer to installation instructions shipped with each Wolf product for detailed specifications.



# BUILT-IN REFRIGERATION

## OVERALL DIMENSIONS

Side-by-Side Refrigerator / Freezer Models

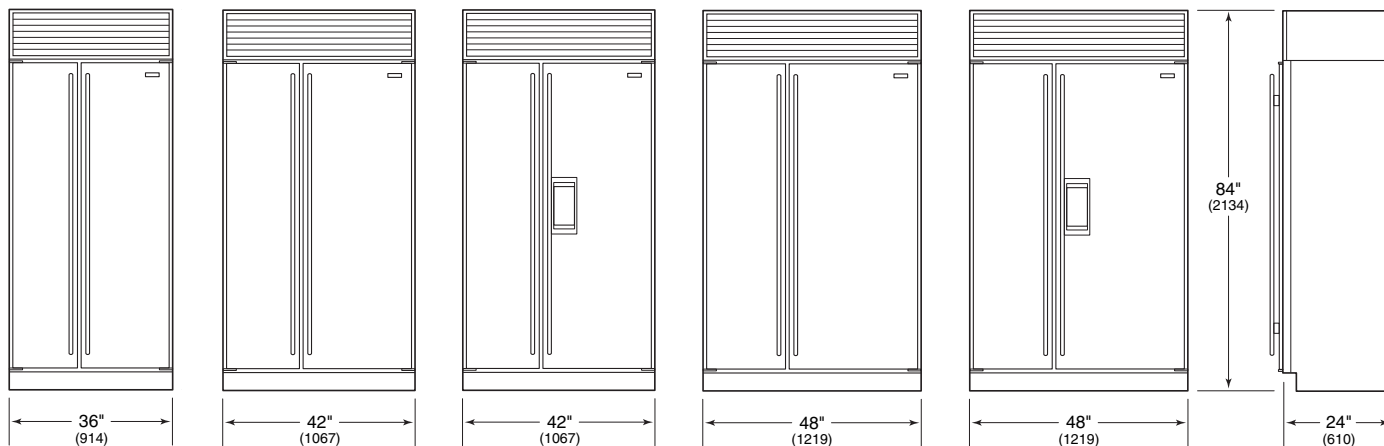

### Model 661

Width **36" (914)**  
 Height **84" (2134)**  
 Depth **24" (610)**

### Model 642

Width **42" (1067)**  
 Height **84" (2134)**  
 Depth **24" (610)**

### Model 685

*Ice / Water Dispensing*

Width **42" (1067)**  
 Height **84" (2134)**  
 Depth **24" (610)**

### Model 632

Width **48" (1219)**  
 Height **84" (2134)**  
 Depth **24" (610)**

### Model 695

*Ice / Water Dispensing*

Width **48" (1219)**  
 Height **84" (2134)**  
 Depth **24" (610)**

Illustrations shown in stainless steel design.

## SIDE-BY-SIDE

### Model 661

### Model 642

### Model 685

*Ice / Water Dispensing*

### Model 632

### Model 695

*Ice / Water Dispensing*

## INSTALLATION SPECIFICATIONS

Side-by-Side Refrigerator / Freezer Models

### Model 661

- A) Rough Opening Width **35 1/2" (902)**
- B) Min Door Clearance **20 3/4" (527)**

### Model 642

- A) Rough Opening Width **41 1/2" (1054)**
- B) Min Door Clearance **25 9/16" (649)**

### Model 685

- A) Rough Opening Width **41 1/2" (1054)**
- B) Min Door Clearance **25 9/16" (649)**

### Model 632

- A) Rough Opening Width **47 1/2" (1206)**
- B) Min Door Clearance **29 1/4" (743)**

### Model 695

- A) Rough Opening Width **47 1/2" (1206)**
- B) Min Door Clearance **29 1/4" (743)**

Dimensions are for finished rough openings.

Door swing clearances are based on stainless steel door and handle dimensions.

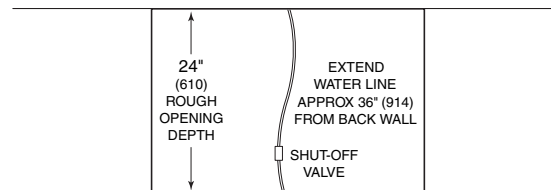

TOP VIEW

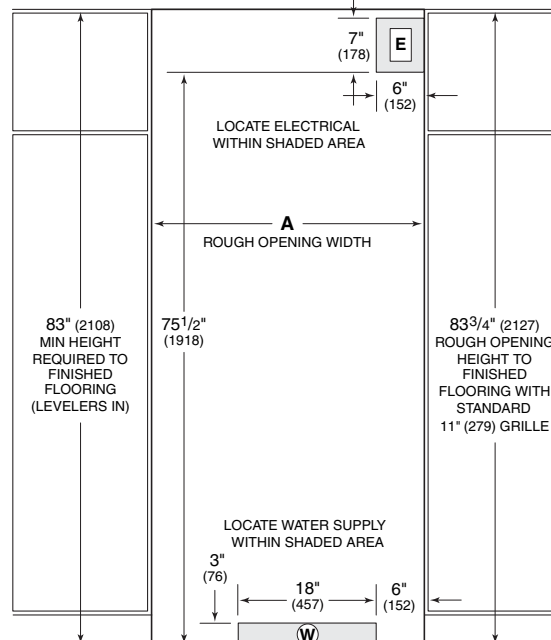

FRONT VIEW

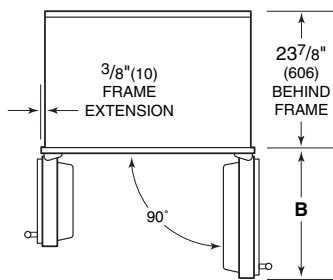

Dimensions in parentheses are in millimeters unless otherwise specified.





OVERALL DIMENSIONS

PRO 48 Side-by-Side Refrigerator | Freezer Models

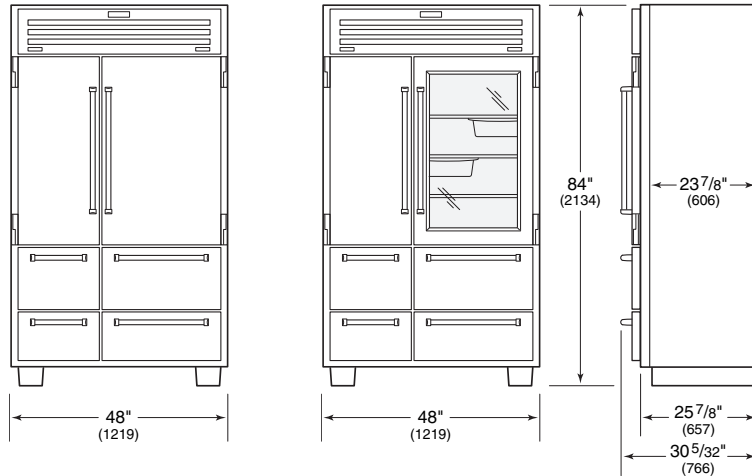

PRO 48  
SIDE-BY-SIDE

**Model 648PRO**  
Built-In or Free-Standing

**Model 648PROG**  
with Glass Door  
Built-In or Free-Standing

**Model 648PRO**

Width **48" (1219)**  
Height **84" (2134)**  
Depth **23 7/8" (606)\***  
**25 7/8" (657)\*\***

**Model 648PROG**  
with Glass Door

Width **48" (1219)**  
Height **84" (2134)**  
Depth **23 7/8" (606)\***  
**25 7/8" (657)\*\***

\*Depth from behind face frame to back of unit for standard installation.  
\*\*Depth from front of face frame to back of unit for flush installation.

INSTALLATION SPECIFICATIONS

PRO 48 Side-by-Side Refrigerator | Freezer Models  
Built-In or Free-Standing

Models 648PRO and 648PROG can be used free-standing or installed as a standard or flush built-in application. For standard built-in installations, the face frame of the unit will extend 2" (51) beyond cabinetry. In flush built-in installations, the front of the face frame will be flush with surrounding cabinetry.

Dimensions are for finished rough openings.

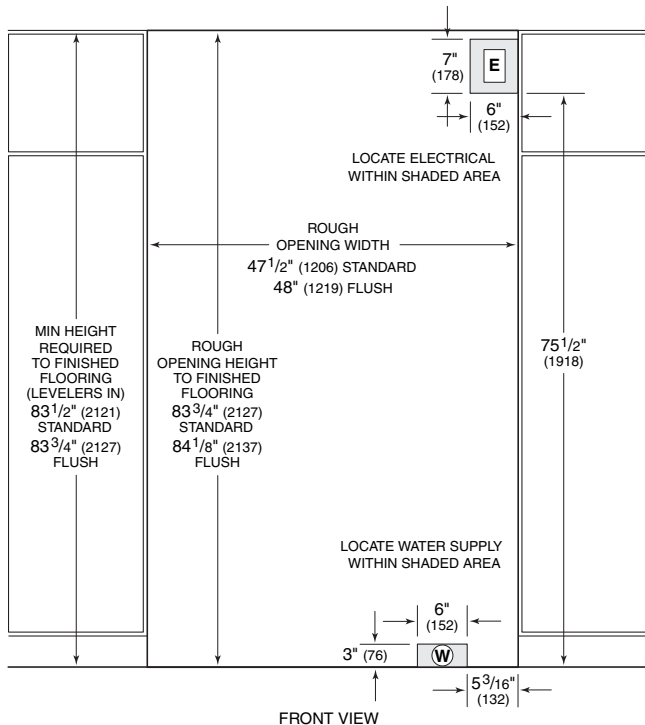
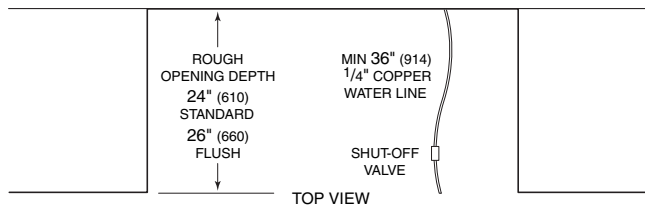
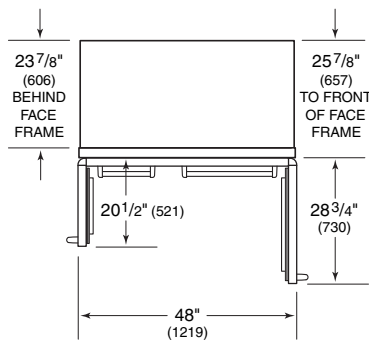

Refer to the full-scale illustrations at the end of this section for specifics on door openings and other specifications.

Refer to installation instructions shipped with each Wolf product for detailed specifications.



ANTI-TIP BLOCKING KIT

To prevent the unit from tipping forward and to provide a stable installation, the unit must be secured in place with an anti-tip blocking kit. If there is a solid soffit above the unit with clearance between the unit and the soffit of 1" (25) or less, you won't need to block the unit. But for installations with clearances of more than 1" (25), you must block the unit with the anti-tip blocking kit (wood block and hardware) provided with each Sub-Zero Built-In model. Refer to the Built-In Installation Instructions packed with the appliance, which provides step-by-step procedures for making sure the unit is installed properly.

ACCESSORIES

Optional accessories are available through your Sub-Zero dealer. To obtain local dealer information, visit the Showroom Locator section of our website, subzero.com.

ADDING PANELS

In your plan for panels, be sure you are working with the Sub-Zero panel design family called for in your design. If you have chosen the stainless steel design, the unit will be shipped complete with wrapped stainless steel doors and handle hardware. You will not have to install door panels.

Specifications on the following pages provide panel dimensions and installation considerations for framed and overlay door panels.

Side panels can be used with the framed, overlay and stainless steel design applications. Refer to specifications on page 26.

FRAMED DOOR PANELS

If you and your client have ordered a framed design model, you will be adding panels to give the unit the custom Sub-Zero look. The framed panel design option is available on all Built-In units except Models 648PRO and 648PROG. For exact door panel dimensions for Built-In framed models, refer to the Framed Panel Specifications on pages 20-21. Also refer to the full-scale illustrations at the end of this section for panel and handle considerations.

The traditional framed models come with an elegant, smooth, full-length handle. Optional extended full-length handles that provide additional finger clearance for raised panels are available through your Sub-Zero dealer.

If the thickness of the custom panels is less than 1/4" (6), they must be backed up with a sheet of shim material to build the total thickness to 1/4" (6). If the panel is thicker than 1/4" (6), an edge must be routed around the panel to ensure a proper fit. Refer to illustrations 1 and 2.

**IMPORTANT NOTE:** On all framed models, routing, recessing or optional extended handles may be required on raised panels for finger clearance under the handle. Refer to the full-scale illustrations at the end of this section.

For glass door Models 601RG, 611G and 650G, the refrigerator door panel must include a cut-out to accommodate the window. Refer to the Framed Panel Specifications on pages 20-21.

**IMPORTANT NOTE:** On glass door models, the glass portion of the door must be exposed and not covered by any part of the panel.

For Models 685 and 695, the refrigerator door panel must include a cut-out to accommodate the glasswell and bezel. The thickness of the panel in this area can range from 1/4" (6) to a maximum of 1 1/8" (29). If the panel is thicker, provisions must be made to rout out a space to accommodate the decorative bezel surrounding the glasswell.

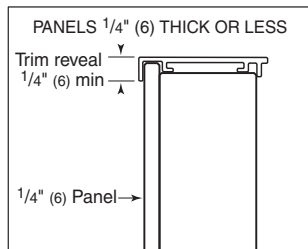

Illus. 1

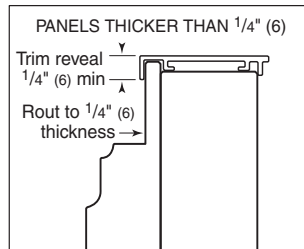

Illus. 2

Dimensions in parentheses are in millimeters unless otherwise specified.



**GLASSWELL PANEL OPTIONS**

If you choose not to use custom wood panels above or below the glasswell for Model 685 or 695 framed application, a stainless steel insert panel will be provided with the partial framed accessory kit. This accessory kit (FRAMPAR), includes partial framed molding and classic stainless steel inset handle panel to provide a spill-resistant finish above and below the glasswell on the refrigerator door only. Refer to the Framed Panel Specifications for this option on page 21.

With the framed retrofit accessory kit, existing Model 680 or 690 door panels can be used on a new Model 685 or 695 framed unit. This accessory kit (FRAMRET) includes framed retrofit moldings and classic stainless steel inset handle panels to accommodate existing Model 680 or 690 framed refrigerator and freezer door panels.

**IMPORTANT NOTE:** When using Model 680 or 690 raised panels with the framed retrofit kit (FRAMRET), a 1/2" (13) trim reveal down to 1/4" (6) thickness is necessary at the bezel in order for the panels to fit properly.

Both accessory kits are available through your Sub-Zero dealer. Refer to the illustrations below.

**OPTIONAL PANEL GRILLE**

An 11" (279) louvered grille is standard on framed applications. Optional louvered grilles are available in 1" (25) height increments from 10" (254) to 15" (381) for all Built-In models except Models 601R, 601RG, 601F, 648PRO and 648PROG.

You may choose to use Sub-Zero's optional panel grille for some of your framed applications. The panel grilles can be used with all Built-In models except Models 601R, 601RG, 601F, 648PRO and 648PROG and are available in 1" (25) height increments from 10" (254) to 15" (381).

For each model, the width of the panel grille will be the same, regardless of the height you have chosen. To determine the panel grille insert size, use the width dimension listed for your model and the height dimension for the grille option you have chosen. Specifications for the Panel Grille Option are listed on page 21.

**PANEL REQUIREMENTS**

The weight of each framed door panel cannot exceed 50 lbs (23 kg).

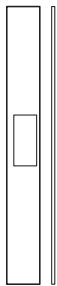

**Partial Framed Kit**  
FRAMPAR

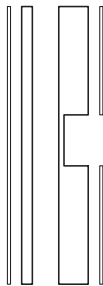

**Framed Retrofit Kit**  
FRAMRET

**FRAMED PANELS**

To install framed panels, see the detailed procedures outlined in the Sub-Zero Built-In Installation Instructions.



# BUILT-IN REFRIGERATION

## FRAMED DOOR PANEL SPECIFICATIONS

All Refrigerator / All Freezer Framed (F) Models

<b>Model 601R</b>	<b>W</b>	<b>H</b>
Refrigerator Framed Panel	<b>34<sup>1</sup>/<sub>8</sub>" (867)</b>	<b>58<sup>15</sup>/<sub>16</sub>" (1497)</b>
Raised Panel Handle Recess Location - Refrigerator Panel	<b>A) 29<sup>15</sup>/<sub>32</sub>" (749)</b>	

<b>Model 601RG</b>	<b>W</b>	<b>H</b>
Refrigerator Framed Panel	<b>34<sup>1</sup>/<sub>8</sub>" (867)</b>	<b>58<sup>15</sup>/<sub>16</sub>" (1497)</b>
Raised Panel Handle Recess Location - Refrigerator Panel	<b>A) 29<sup>15</sup>/<sub>32</sub>" (749)</b>	
Window Cut-Out Dimensions	<b>25<sup>3</sup>/<sub>8</sub>" (645)</b>	<b>41<sup>3</sup>/<sub>16</sub>" (1046)</b>
Window Cut-Out Location	<b>C) 4<sup>3</sup>/<sub>8</sub>" (111)</b>	<b>D) 13<sup>3</sup>/<sub>8</sub>" (340)</b>

<b>Model 601F</b>	<b>W</b>	<b>H</b>
Freezer Framed Panel	<b>34<sup>1</sup>/<sub>8</sub>" (867)</b>	<b>58<sup>15</sup>/<sub>16</sub>" (1497)</b>
Raised Panel Handle Recess Location - Freezer Panel	<b>A) 29<sup>15</sup>/<sub>32</sub>" (749)</b>	

**IMPORTANT NOTE:** Panel specifications are for Built-In framed (F) models. Panel specifications for overlay models are on pages 24-25.

## FRAMED DOOR PANEL SPECIFICATIONS

Over-and-Under Framed (F) Models

<b>Model 611</b>	<b>W</b>	<b>H</b>
Refrigerator Framed Panel	<b>28<sup>1</sup>/<sub>8</sub>" (714)</b>	<b>48<sup>1</sup>/<sub>16</sub>" (1221)</b>
Freezer Framed Panel	<b>28<sup>1</sup>/<sub>8</sub>" (714)</b>	<b>18<sup>3</sup>/<sub>8</sub>" (467)</b>
Raised Panel Handle Recess Location - Refrigerator Panel	<b>A) 24<sup>1</sup>/<sub>32</sub>" (610)</b>	
Freezer Panel	<b>B) 14<sup>1</sup>/<sub>16</sub>" (357)</b>	

<b>Model 611G</b>	<b>W</b>	<b>H</b>
Refrigerator Framed Panel	<b>28<sup>1</sup>/<sub>8</sub>" (714)</b>	<b>48<sup>1</sup>/<sub>16</sub>" (1221)</b>
Freezer Framed Panel	<b>28<sup>1</sup>/<sub>8</sub>" (714)</b>	<b>18<sup>3</sup>/<sub>8</sub>" (467)</b>
Raised Panel Handle Recess Location - Refrigerator Panel	<b>A) 24<sup>1</sup>/<sub>32</sub>" (610)</b>	
Freezer Panel	<b>B) 14<sup>1</sup>/<sub>16</sub>" (357)</b>	
Window Cut-Out Dimensions	<b>19<sup>3</sup>/<sub>8</sub>" (492)</b>	<b>39<sup>5</sup>/<sub>16</sub>" (999)</b>
Window Cut-Out Location	<b>C) 4<sup>3</sup>/<sub>8</sub>" (111)</b>	<b>D) 4<sup>3</sup>/<sub>8</sub>" (111)</b>

<b>Model 650</b>	<b>W</b>	<b>H</b>
Refrigerator Framed Panel	<b>34<sup>1</sup>/<sub>8</sub>" (867)</b>	<b>48<sup>1</sup>/<sub>16</sub>" (1221)</b>
Freezer Framed Panel	<b>34<sup>1</sup>/<sub>8</sub>" (867)</b>	<b>18<sup>3</sup>/<sub>8</sub>" (467)</b>
Raised Panel Handle Recess Location - Refrigerator Panel	<b>A) 24<sup>1</sup>/<sub>32</sub>" (610)</b>	
Freezer Panel	<b>B) 17<sup>1</sup>/<sub>16</sub>" (433)</b>	

<b>Model 650G</b>	<b>W</b>	<b>H</b>
Refrigerator Framed Panel	<b>34<sup>1</sup>/<sub>8</sub>" (867)</b>	<b>48<sup>1</sup>/<sub>16</sub>" (1221)</b>
Freezer Framed Panel	<b>34<sup>1</sup>/<sub>8</sub>" (867)</b>	<b>18<sup>3</sup>/<sub>8</sub>" (467)</b>
Raised Panel Handle Recess Location - Refrigerator Panel	<b>A) 24<sup>1</sup>/<sub>32</sub>" (610)</b>	
Freezer Panel	<b>B) 17<sup>1</sup>/<sub>16</sub>" (433)</b>	
Window Cut-Out Dimensions	<b>25<sup>3</sup>/<sub>8</sub>" (645)</b>	<b>39<sup>5</sup>/<sub>16</sub>" (999)</b>
Window Cut-Out Location	<b>C) 4<sup>3</sup>/<sub>8</sub>" (111)</b>	<b>D) 4<sup>3</sup>/<sub>8</sub>" (111)</b>

**IMPORTANT NOTE:** Panel specifications are for Built-In framed (F) models. Panel specifications for overlay models are on pages 24-25.

## FRAMED PANELS

Panel specifications are for Built-In framed (F) models.

Dimensions in parentheses are in millimeters unless otherwise specified.

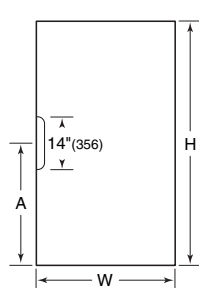

**Models 601R and 601F**

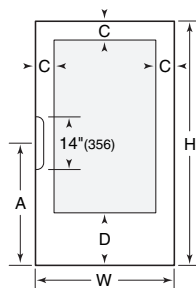

**Model 601RG**

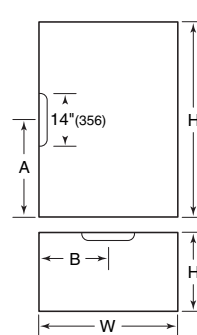

**Models 611 and 650**

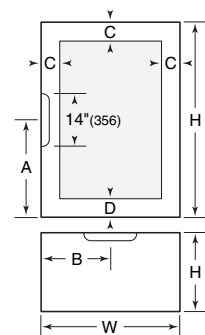

**Models 611G and 650G**



FRAMED DOOR PANEL SPECIFICATIONS

Side-by-Side Framed (F) Models

	<b>W</b>	<b>H</b>
Refrigerator Framed Panel	<b>19<sup>1</sup>/<sub>8</sub>" (486)</b>	<b>67<sup>11</sup>/<sub>16</sub>" (1719)</b>
Freezer Framed Panel	<b>14<sup>5</sup>/<sub>8</sub>" (371)</b>	<b>67<sup>11</sup>/<sub>16</sub>" (1719)</b>

Raised Panel Handle Recess Location -

Refrigerator   Freezer Panel	<b>A) 38<sup>5</sup>/<sub>32</sub>" (969)</b>
------------------------------	---

	<b>W</b>	<b>H</b>
Refrigerator Framed Panel	<b>24" (610)</b>	<b>67<sup>11</sup>/<sub>16</sub>" (1719)</b>
Freezer Framed Panel	<b>15<sup>5</sup>/<sub>8</sub>" (397)</b>	<b>67<sup>11</sup>/<sub>16</sub>" (1719)</b>

Raised Panel Handle Recess Location -

Refrigerator   Freezer Panel	<b>A) 38<sup>5</sup>/<sub>32</sub>" (969)</b>
------------------------------	---

	<b>W</b>	<b>H</b>
Refrigerator Framed Panel	<b>24" (610)</b>	<b>67<sup>11</sup>/<sub>16</sub>" (1719)</b>
Freezer Framed Panel	<b>15<sup>5</sup>/<sub>8</sub>" (397)</b>	<b>67<sup>11</sup>/<sub>16</sub>" (1719)</b>
Glasswell Cut-Out Dimensions	<b>5<sup>7</sup>/<sub>8</sub>" (150)</b>	<b>12<sup>7</sup>/<sub>16</sub>" (315)</b>
Glasswell Location (Refrigerator)	<b>E) 1<sup>9</sup>/<sub>16</sub>" (39)</b>	<b>F) 28<sup>9</sup>/<sub>16</sub>" (726)</b>

	<b>W</b>	<b>H</b>
Refrigerator Framed Panel	<b>27<sup>11</sup>/<sub>16</sub>" (703)</b>	<b>67<sup>11</sup>/<sub>16</sub>" (1719)</b>
Freezer Framed Panel	<b>17<sup>15</sup>/<sub>16</sub>" (456)</b>	<b>67<sup>11</sup>/<sub>16</sub>" (1719)</b>

Raised Panel Handle Recess Location -

Refrigerator   Freezer Panel	<b>A) 38<sup>5</sup>/<sub>32</sub>" (969)</b>
------------------------------	---

	<b>W</b>	<b>H</b>
Refrigerator Framed Panel	<b>27<sup>11</sup>/<sub>16</sub>" (703)</b>	<b>67<sup>11</sup>/<sub>16</sub>" (1719)</b>
Freezer Framed Panel	<b>17<sup>15</sup>/<sub>16</sub>" (456)</b>	<b>67<sup>11</sup>/<sub>16</sub>" (1719)</b>
Glasswell Cut-Out Dimensions	<b>5<sup>7</sup>/<sub>8</sub>" (150)</b>	<b>12<sup>7</sup>/<sub>16</sub>" (315)</b>
Glasswell Location (Refrigerator)	<b>E) 1<sup>9</sup>/<sub>16</sub>" (39)</b>	<b>F) 28<sup>9</sup>/<sub>16</sub>" (726)</b>

**IMPORTANT NOTE:** Panel specifications are for Built-In framed (F) models. Panel specifications for overlay models are on pages 24-25.

For Models 685 and 695, panel thickness in the glasswell area can range from 1/4" (6) to a maximum of 1 1/8" (29). If the panel is thicker, you must rout out a minimum 1/4" (6) flat landing area to accommodate the bezel surrounding the glasswell.

PARTIAL FRAMED DOOR PANEL OPTION

Ice | Water Dispensing Framed (F) Models

	<b>W</b>	<b>H</b>
Refrigerator Partial Framed Panel	<b>15<sup>5</sup>/<sub>8</sub>" (397)</b>	<b>67<sup>11</sup>/<sub>16</sub>" (1719)</b>
Freezer Partial Framed Panel	<b>15<sup>5</sup>/<sub>8</sub>" (397)</b>	<b>67<sup>11</sup>/<sub>16</sub>" (1719)</b>

	<b>W</b>	<b>H</b>
Refrigerator Partial Framed Panel	<b>17<sup>15</sup>/<sub>16</sub>" (456)</b>	<b>67<sup>11</sup>/<sub>16</sub>" (1719)</b>
Freezer Partial Framed Panel	<b>17<sup>15</sup>/<sub>16</sub>" (456)</b>	<b>67<sup>11</sup>/<sub>16</sub>" (1719)</b>

The partial framed accessory kit (FRAMPAR) is required for this option. Kit includes partial framed molding and classic stainless steel inset handle panels for above and below glasswell on the refrigerator door.

PANEL GRILLE OPTION

Framed (F) Models

<b>Models 611 and 611G</b>	<b>W</b>
Grille Panel Width	<b>28<sup>3</sup>/<sub>16</sub>" (716)</b>
<b>Models 650, 650G, 661</b>	<b>W</b>
Grille Panel Width	<b>34<sup>3</sup>/<sub>16</sub>" (868)</b>
<b>Models 642 and 685</b>	<b>W</b>
Grille Panel Width	<b>40<sup>3</sup>/<sub>16</sub>" (1021)</b>
<b>Models 632 and 695</b>	<b>W</b>
Grille Panel Width	<b>46<sup>3</sup>/<sub>16</sub>" (1173)</b>
<b>10" (254) Grille</b>	<b>H</b>
Grille Panel Height	<b>8<sup>15</sup>/<sub>16</sub>" (227)</b>
<b>11" (279) Grille (standard)</b>	<b>H</b>
Grille Panel Height	<b>9<sup>15</sup>/<sub>16</sub>" (252)</b>
<b>12" (305) Grille Height</b>	<b>H</b>
Grille Panel Height	<b>10<sup>15</sup>/<sub>16</sub>" (278)</b>
<b>13" (330) Grille</b>	<b>H</b>
Grille Panel Height	<b>11<sup>15</sup>/<sub>16</sub>" (303)</b>
<b>14" (356) Grille</b>	<b>H</b>
Grille Panel Height	<b>12<sup>15</sup>/<sub>16</sub>" (329)</b>
<b>15" (381) Grille</b>	<b>H</b>
Grille Panel Height	<b>13<sup>15</sup>/<sub>16</sub>" (354)</b>

For panel grille insert size, use width dimension listed for your model and height dimension for grille option. 11" (279) grille is standard.

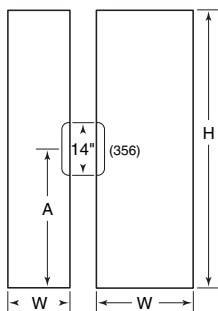

**Models 661, 642 and 632**

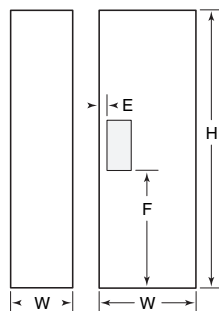

**Models 685 and 695**

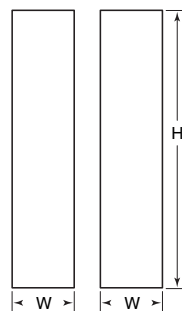

**Models 685 and 695 Partial Framed Option**

FRAMED PANELS

To install framed panels, see the detailed procedures outlined in the Sub-Zero Built-In Installation Instructions.



OVERLAY DOOR PANELS

If you and your client have ordered an overlay design model, you will be adding panels to give the unit the custom Sub-Zero look. The overlay panel design option is available on all Built-In units except Models 648PRO and 648PROG.

For exact door panel dimensions for Built-In overlay models, refer to the Overlay Panel Specifications on pages 24-25.

PANEL REQUIREMENTS

The overlay door panel assembly must be a minimum of 5/8" (16) thick and cannot exceed 50 lbs (23 kg).

The overlay design allows decorative panels to cover the door trim for a more seamless appearance that blends with the design of the room. To achieve this look, the most common way is to work with three panels—the decorative overlay panel, a 0.10" (3) spacer panel and a 1/4" (6) backer panel. Depending on your cabinet manufacturer, this could be one panel routed for different dimensions or, more likely, three different panels.

Regardless of the physical construction of the panels (routing or three-panel assembly), you will need to follow the Overlay Panel Specifications on the following pages for exact sizing and panel placement to ensure a proper fit.

Illustration 3 is a cross section view of the three-panel assembly showing placement of the door, drawer or grille trim. Illustration 4 shows a rear view of the three-panel assembly and critical dimensions, standard for all models.

**IMPORTANT NOTE:** Keep in mind that the Sub-Zero door panels have the potential for hitting adjacent cabinets and/or countertops when they are opened. You need to be aware of your surrounding cabinetry and space limitations when using the overlay models. Refer to the full-scale illustrations at the end of this section.

If you are using an overlay door panel with Model 611, 611G, 650 or 650G, it is necessary to rout a space for the unit's lower hinge plate so it does not strike the door panel. Refer to illustration 5.

For Models 611, 611G, 650 and 650G, you will minimize the reveal between the bottom of the overlay door panel and the top of the overlay drawer panel. Refer to illustration 6.

**IMPORTANT NOTE:** If you choose not to rout a space for the lower hinge plate, you can reduce the total height of the overlay panel (decorative panel only) by 1/2" (13).

**CAUTION**  
Do not exceed the overlay decorative panel dimensions for Models 611, 611G, 650 or 650G listed on page 24. If you try to make the reveal tighter between the door and drawer panels, the panels may hit when opening and closing, causing possible damage to the panels and the Sub-Zero unit.

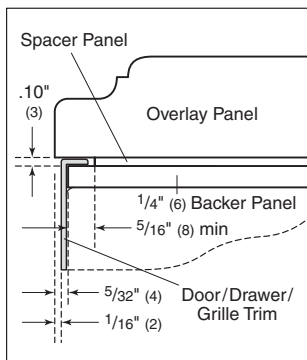

Illus. 3

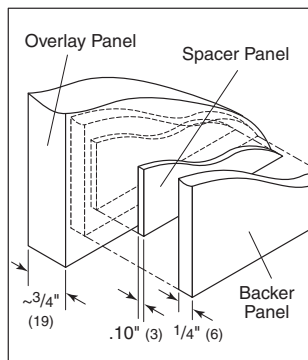

Illus. 4

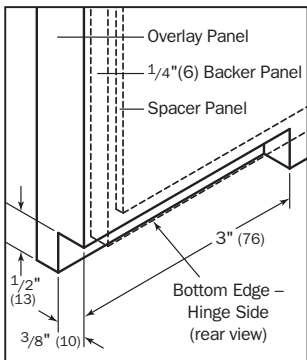

Illus. 5

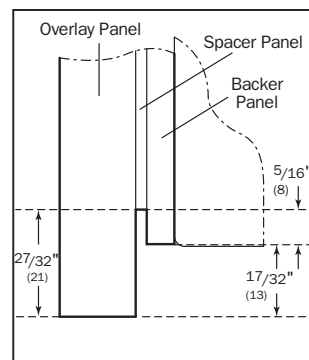

Illus. 6



**OVERLAY DOOR PANELS**

For glass door Models 601RG, 611G and 650G, the refrigerator door panel must include a cut-out to accommodate the window. Refer to the Overlay Panel Specifications for Models 601RG, 611G and 650G on page 24.

**IMPORTANT NOTE:** On glass door models, the glass portion of the door must be exposed and not covered by any part of the panel.

For Models 685 and 695, the refrigerator door panel must include a cut-out to accommodate the glasswell and bezel. The thickness of the panel in this area can range from 1/4" (6) to a maximum of 1 1/8" (29).

**IMPORTANT NOTE:** Regardless of the thickness of the overlay panel for Model 685 or 695, you must plan for a flat 'landing' space for the decorative bezel surrounding the glasswell area. Refer to page 25 for exact cut-out dimensions of the glasswell area in the overlay, spacer and backer panels. This 'landing' area can be accomplished in a number of different ways. We are showing two in Illustrations 7 and 8 below.

Illustration 7 shows how you can recess the bezel to the inset panel. You must rout out a space to accommodate the 12 7/8" (327) height of the bezel. Also keep in mind that the amount of material you will rout out of the stile will vary because of the thickness of this element. However, the width of the stile immediately adjacent to the bezel must be 1 7/16" (37). DO NOT cut the entire stile to this dimension. In this illustration you can see that rails above and below the bezel give this a finished look. Make sure that the bezel is not supporting weight from the panel.

Illustration 8 shows how you can box out a landing space for the bezel using stiles and rails to create this space. Again, keep in mind, that the total thickness of the panel at this level must not exceed 1 1/8" (29).

**OVERLAY PANEL GRILLE**

Overlay grille panels for the panel grille match the design of the door panels. Overlay units, except Models 601R, 601RG and 601F, come standard with an 11" (279) panel grille. Optional grilles are available in 1" (25) height increments from 10" (254) to 15" (381). Overlay grille panel specifications for the panel grille are listed on page 25. Also refer to illustration 4 on page 22 for additional overlay panel dimensions.

OVERLAY PANELS

To install overlay panels, see the detailed procedures outlined in the Sub-Zero Built-In Installation Instructions.

**⚠ CAUTION**

Do not exceed the panel dimensions listed for the appropriate overlay grille panel you are specifying. The decorative panel cannot be any larger or it may restrict the airflow to the compressor area and cause problems with the operation of the Sub-Zero unit.

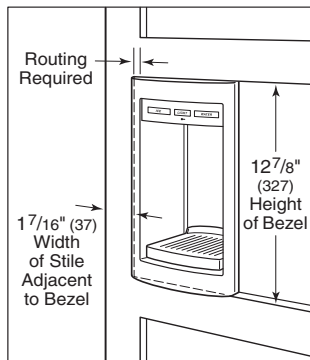

Illus. 7

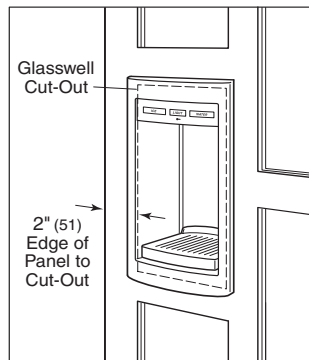

Illus. 8

Dimensions in parentheses are in millimeters unless otherwise specified.



# BUILT-IN REFRIGERATION

## OVERLAY DOOR PANEL SPECIFICATIONS

All Refrigerator / All Freezer Overlay (O) Models

Model 601R	W	H
Refrigerator Overlay Panel	34 <sup>7</sup> / <sub>16</sub> " (875)	59 <sup>1</sup> / <sub>4</sub> " (1505)
Refrigerator Spacer Panel	33 <sup>1</sup> / <sub>2</sub> " (851)	58 <sup>5</sup> / <sub>16</sub> " (1481)
Refrigerator Backer Panel	34 <sup>1</sup> / <sub>8</sub> " (867)	58 <sup>15</sup> / <sub>16</sub> " (1497)

Model 601RG	W	H
Refrigerator Overlay Panel	34 <sup>7</sup> / <sub>16</sub> " (875)	59 <sup>1</sup> / <sub>4</sub> " (1505)
Refrigerator Spacer Panel	33 <sup>1</sup> / <sub>2</sub> " (851)	58 <sup>5</sup> / <sub>16</sub> " (1481)
Refrigerator Backer Panel	34 <sup>1</sup> / <sub>8</sub> " (867)	58 <sup>15</sup> / <sub>16</sub> " (1497)
Window Cut-Out Dimensions	25 <sup>7</sup> / <sub>16</sub> " (646)	41 <sup>1</sup> / <sub>4</sub> " (1048)
Window Cut-Out Location	C) 4 <sup>1</sup> / <sub>2</sub> " (114)	D) 13 <sup>1</sup> / <sub>2</sub> " (343)

Model 601F	W	H
Freezer Overlay Panel	34 <sup>7</sup> / <sub>16</sub> " (875)	59 <sup>1</sup> / <sub>4</sub> " (1505)
Freezer Spacer Panel	33 <sup>1</sup> / <sub>2</sub> " (851)	58 <sup>5</sup> / <sub>16</sub> " (1481)
Freezer Backer Panel	34 <sup>1</sup> / <sub>8</sub> " (867)	58 <sup>15</sup> / <sub>16</sub> " (1497)

IMPORTANT NOTE: Panel specifications are for Built-In overlay (O) models. Panel specifications for framed models are on pages 20-21.

## OVERLAY DOOR PANEL SPECIFICATIONS

Over-and-Under Overlay (O) Models

Model 611	W	H
Refrigerator Overlay Panel	28 <sup>7</sup> / <sub>16</sub> " (722)	48 <sup>7</sup> / <sub>8</sub> " (1241)
Refrigerator Spacer Panel	27 <sup>1</sup> / <sub>2</sub> " (699)	47 <sup>7</sup> / <sub>16</sub> " (1205)
Refrigerator Backer Panel	28 <sup>1</sup> / <sub>8</sub> " (714)	48 <sup>1</sup> / <sub>16</sub> " (1221)
Freezer Overlay Panel	28 <sup>7</sup> / <sub>16</sub> " (722)	18 <sup>11</sup> / <sub>16</sub> " (475)
Freezer Spacer Panel	27 <sup>1</sup> / <sub>2</sub> " (699)	17 <sup>3</sup> / <sub>4</sub> " (451)
Freezer Backer Panel	28 <sup>1</sup> / <sub>8</sub> " (714)	18 <sup>3</sup> / <sub>8</sub> " (467)

Model 611G	W	H
Refrigerator Overlay Panel	28 <sup>7</sup> / <sub>16</sub> " (722)	48 <sup>7</sup> / <sub>8</sub> " (1241)
Refrigerator Spacer Panel	27 <sup>1</sup> / <sub>2</sub> " (699)	47 <sup>7</sup> / <sub>16</sub> " (1205)
Refrigerator Backer Panel	28 <sup>1</sup> / <sub>8</sub> " (714)	48 <sup>1</sup> / <sub>16</sub> " (1221)
Freezer Overlay Panel	28 <sup>7</sup> / <sub>16</sub> " (722)	18 <sup>11</sup> / <sub>16</sub> " (475)
Freezer Spacer Panel	27 <sup>1</sup> / <sub>2</sub> " (699)	17 <sup>3</sup> / <sub>4</sub> " (451)
Freezer Backer Panel	28 <sup>1</sup> / <sub>8</sub> " (714)	18 <sup>3</sup> / <sub>8</sub> " (467)
Window Cut-Out Dimensions	19 <sup>7</sup> / <sub>16</sub> " (494)	39 <sup>3</sup> / <sub>8</sub> " (1000)
Window Cut-Out Location	C) 4 <sup>1</sup> / <sub>2</sub> " (114)	D) 5" (127)

Model 650	W	H
Refrigerator Overlay Panel	34 <sup>7</sup> / <sub>16</sub> " (875)	48 <sup>7</sup> / <sub>8</sub> " (1241)
Refrigerator Spacer Panel	33 <sup>1</sup> / <sub>2</sub> " (851)	47 <sup>7</sup> / <sub>16</sub> " (1205)
Refrigerator Backer Panel	34 <sup>1</sup> / <sub>8</sub> " (867)	48 <sup>1</sup> / <sub>16</sub> " (1221)
Freezer Overlay Panel	34 <sup>7</sup> / <sub>16</sub> " (875)	18 <sup>11</sup> / <sub>16</sub> " (475)
Freezer Spacer Panel	33 <sup>1</sup> / <sub>2</sub> " (851)	17 <sup>3</sup> / <sub>4</sub> " (451)
Freezer Backer Panel	34 <sup>1</sup> / <sub>8</sub> " (867)	18 <sup>3</sup> / <sub>8</sub> " (467)

Model 650G	W	H
Refrigerator Overlay Panel	34 <sup>7</sup> / <sub>16</sub> " (875)	48 <sup>7</sup> / <sub>8</sub> " (1241)
Refrigerator Spacer Panel	33 <sup>1</sup> / <sub>2</sub> " (851)	47 <sup>7</sup> / <sub>16</sub> " (1205)
Refrigerator Backer Panel	34 <sup>1</sup> / <sub>8</sub> " (867)	48 <sup>1</sup> / <sub>16</sub> " (1221)
Freezer Overlay Panel	34 <sup>7</sup> / <sub>16</sub> " (875)	18 <sup>11</sup> / <sub>16</sub> " (475)
Freezer Spacer Panel	33 <sup>1</sup> / <sub>2</sub> " (851)	17 <sup>3</sup> / <sub>4</sub> " (451)
Freezer Backer Panel	34 <sup>1</sup> / <sub>8</sub> " (867)	18 <sup>3</sup> / <sub>8</sub> " (467)
Window Cut-Out Dimensions	25 <sup>7</sup> / <sub>16</sub> " (646)	39 <sup>3</sup> / <sub>8</sub> " (1000)
Window Cut-Out Location	C) 4 <sup>1</sup> / <sub>2</sub> " (114)	D) 5" (127)

IMPORTANT NOTE: Panel specifications are for Built-In overlay (O) models. Panel specifications for framed models are on pages 20-21.

## OVERLAY PANELS

Panel specifications are for Built-In overlay (O) models.

Dimensions in parentheses are in millimeters unless otherwise specified.

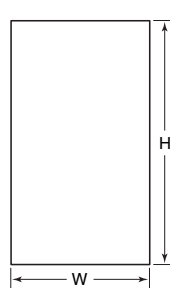

Models 601R and 601F

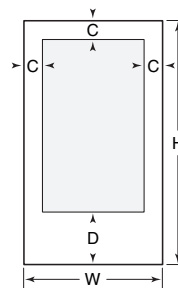

Model 601RG

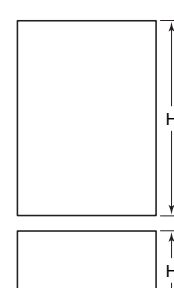

Models 611 and 650

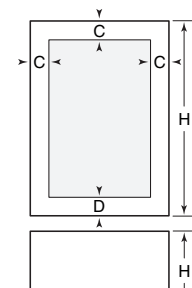

Models 611G and 650G





OVERLAY DOOR PANEL SPECIFICATIONS

Side-by-Side Overlay (O) Models

Model 661	W	H
Refrigerator Overlay Panel	19 <sup>7</sup> / <sub>16</sub> " (494)	68" (1727)
Refrigerator Spacer Panel	18 <sup>1</sup> / <sub>2</sub> " (470)	67 <sup>1</sup> / <sub>16</sub> " (1703)
Refrigerator Backer Panel	19 <sup>1</sup> / <sub>8</sub> " (486)	67 <sup>11</sup> / <sub>16</sub> " (1719)
Freezer Overlay Panel	14 <sup>15</sup> / <sub>16</sub> " (379)	68" (1727)
Freezer Spacer Panel	14" (356)	67 <sup>1</sup> / <sub>16</sub> " (1703)
Freezer Backer Panel	14 <sup>5</sup> / <sub>8</sub> " (371)	67 <sup>11</sup> / <sub>16</sub> " (1719)

Models 642 and 685	W	H
Refrigerator Overlay Panel	24 <sup>5</sup> / <sub>16</sub> " (618)	68" (1727)
Refrigerator Spacer Panel	23 <sup>3</sup> / <sub>8</sub> " (594)	67 <sup>1</sup> / <sub>16</sub> " (1703)
Refrigerator Backer Panel	24" (610)	67 <sup>11</sup> / <sub>16</sub> " (1719)
Freezer Overlay Panel	15 <sup>15</sup> / <sub>16</sub> " (405)	68" (1727)
Freezer Spacer Panel	15" (381)	67 <sup>1</sup> / <sub>16</sub> " (1703)
Freezer Backer Panel	15 <sup>5</sup> / <sub>8</sub> " (397)	67 <sup>11</sup> / <sub>16</sub> " (1719)

Models 632 and 695	W	H
Refrigerator Overlay Panel	28" (711)	68" (1727)
Refrigerator Spacer Panel	27 <sup>1</sup> / <sub>16</sub> " (687)	67 <sup>1</sup> / <sub>16</sub> " (1703)
Refrigerator Backer Panel	27 <sup>11</sup> / <sub>16</sub> " (703)	67 <sup>11</sup> / <sub>16</sub> " (1719)
Freezer Overlay Panel	18 <sup>1</sup> / <sub>4</sub> " (464)	68" (1727)
Freezer Spacer Panel	17 <sup>5</sup> / <sub>16</sub> " (440)	67 <sup>1</sup> / <sub>16</sub> " (1703)
Freezer Backer Panel	17 <sup>15</sup> / <sub>16</sub> " (456)	67 <sup>11</sup> / <sub>16</sub> " (1719)

Glasswell Cut-Out - Models 685 and 695	W	H
Glasswell Cut-Out Dimensions	5 <sup>7</sup> / <sub>8</sub> " (150)	12 <sup>7</sup> / <sub>16</sub> " (315)
Glasswell Location (Overlay)	E) 1 <sup>11</sup> / <sub>16</sub> " (43)	F) 28 <sup>3</sup> / <sub>4</sub> " (730)
Glasswell Location (Spacer)	E) 1 <sup>1</sup> / <sub>4</sub> " (31)	F) 28 <sup>1</sup> / <sub>4</sub> " (718)
Glasswell Location (Backer)	E) 1 <sup>9</sup> / <sub>16</sub> " (39)	F) 28 <sup>9</sup> / <sub>16</sub> " (726)

**IMPORTANT NOTE:** Panel specifications are for Built-In overlay (O) models. Panel specifications for framed models are on pages 20-21.

For Models 685 and 695, panel thickness in the glasswell area can range from 1/4" (6) to a maximum of 1 1/8" (29). If the panel is thicker, you must rout out a minimum 1/4" (6) flat landing area to accommodate the bezel surrounding the glasswell.

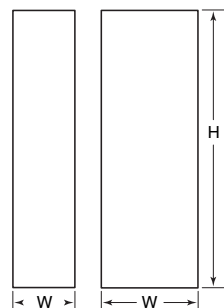

Models 661, 642 and 632

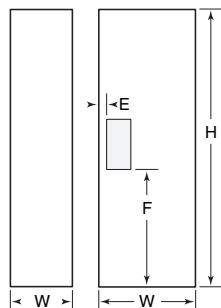

Models 685 and 695

OVERLAY GRILLE PANEL

Overlay (O) Models  
Width Dimensions

Models 611 and 611G	W
Overlay Panel Width	28 <sup>7</sup> / <sub>16</sub> " (722)
Spacer Panel Width	27 <sup>1</sup> / <sub>2</sub> " (699)
Backer Panel Width	28 <sup>1</sup> / <sub>8</sub> " (714)

Models 650, 650G, 661	W
Overlay Panel Width	34 <sup>7</sup> / <sub>16</sub> " (875)
Spacer Panel Width	33 <sup>1</sup> / <sub>2</sub> " (851)
Backer Panel Width	34 <sup>1</sup> / <sub>8</sub> " (867)

Models 642 and 685	W
Overlay Panel Width	40 <sup>7</sup> / <sub>16</sub> " (1027)
Spacer Panel Width	39 <sup>1</sup> / <sub>2</sub> " (1003)
Backer Panel Width	40 <sup>1</sup> / <sub>8</sub> " (1019)

Models 632 and 695	W
Overlay Panel Width	46 <sup>7</sup> / <sub>16</sub> " (1180)
Spacer Panel Width	45 <sup>1</sup> / <sub>2</sub> " (1156)
Backer Panel Width	46 <sup>1</sup> / <sub>8</sub> " (1172)

Height Dimensions

10" (254) Grille	H
Overlay Panel Height	9 <sup>1</sup> / <sub>4</sub> " (235)
Spacer Panel Height	8 <sup>5</sup> / <sub>16</sub> " (211)
Backer Panel Height	8 <sup>15</sup> / <sub>16</sub> " (227)

11" (279) Grille (standard)	H
Overlay Panel Height	10 <sup>1</sup> / <sub>4</sub> " (260)
Spacer Panel Height	9 <sup>5</sup> / <sub>16</sub> " (237)
Backer Panel Height	9 <sup>15</sup> / <sub>16</sub> " (252)

12" (305) Grille Height	H
Overlay Panel Height	11 <sup>1</sup> / <sub>4</sub> " (286)
Spacer Panel Height	10 <sup>5</sup> / <sub>16</sub> " (262)
Backer Panel Height	10 <sup>15</sup> / <sub>16</sub> " (278)

13" (330) Grille	H
Overlay Panel Height	12 <sup>1</sup> / <sub>4</sub> " (311)
Spacer Panel Height	11 <sup>5</sup> / <sub>16</sub> " (287)
Backer Panel Height	11 <sup>15</sup> / <sub>16</sub> " (303)

14" (356) Grille	H
Overlay Panel Height	13 <sup>1</sup> / <sub>4</sub> " (337)
Spacer Panel Height	12 <sup>5</sup> / <sub>16</sub> " (313)
Backer Panel Height	12 <sup>15</sup> / <sub>16</sub> " (329)

15" (381) Grille	H
Overlay Panel Height	14 <sup>1</sup> / <sub>4</sub> " (362)
Spacer Panel Height	13 <sup>5</sup> / <sub>16</sub> " (338)
Backer Panel Height	13 <sup>15</sup> / <sub>16</sub> " (354)

For grille panel size, use width dimensions listed for your model and height dimensions for grille option. 11" (279) grille is standard.

Panel grille is available for all overlay units except Models 601R, 601RG and 601F.

OVERLAY PANELS

To install overlay panels, see the detailed procedures outlined in the Sub-Zero Built-In Installation Instructions.



**HANDLE HARDWARE**

Overlay models come without handle hardware. The beauty of this design is that you can match the surrounding cabinet hardware. You or the cabinet manufacturer must provide handle hardware to match the overall decorating scheme.

The handle hardware must be installed before installing the panel assembly. Use larger D-style handles. If screws with thick heads are used, the screws will need to be countersunk into the door before the panel is put into place.

**IMPORTANT NOTE:** Sub-Zero does not recommend using single pull knobs on any of its Built-In models.

For overlay Models 685 and 695, mounting placement of the refrigerator door handle must assure proper access to the glasswell and adequate clearance under the handle. Illustration 9 shows placement of the refrigerator door handle in relationship to the glasswell bezel on stainless steel models.

Optional stainless steel handles are available in a variety of diameters and lengths, as are handles to match the color and style of Wolf ovens. Contact your Sub-Zero dealer for specifics.

Refer to the full-scale illustrations at the end of this section for handle hardware considerations.

**SIDE PANELS**

Side panels can be used with the framed, overlay and stainless steel design applications. When planning for side panels with the installation of a Built-In model, you need to be aware of space configuration to achieve a pleasing fit. Depending on the exact panel you are using with your unit, the height of the panel will vary.

Cut-outs around the toe kick and grille area are required if a 1/4" (6) thick panel will be inserted into the main frame channel. The panel will need to be 24" (610) deep. If a 3/8" (10) thick panel is used, the panel will abut the main frame and should be 23 7/8" (606) deep. Refer to illustrations 10-12 below for placement of toe kick and grille area cut-outs for your specific model. These dimensions do not apply to Models 648PRO and 648PROG.

The toe kick area may or may not be cut out depending on the look you want to achieve.

**IMPORTANT NOTE:** The use of side panels may change the width of your rough opening.

ACCESSORIES

Optional accessories are available through your Sub-Zero dealer. To obtain local dealer information, visit the Showroom Locator section of our website, [subzero.com](http://subzero.com).

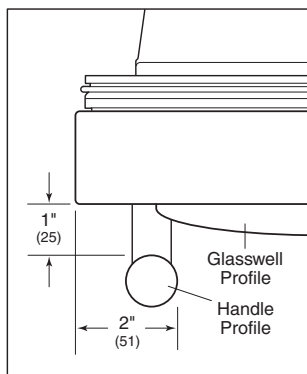

Illus. 9

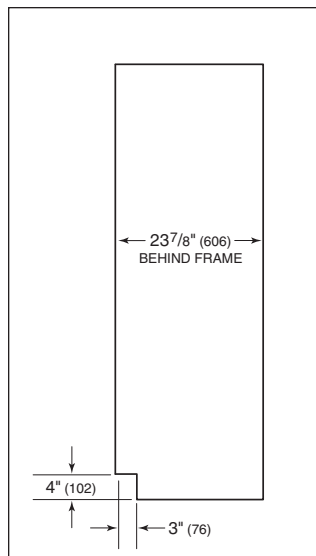

Illus. 10—Models 601R, 601RG and 601F

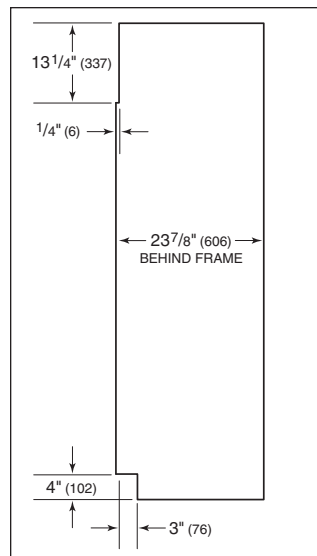

Illus. 11—Models 611, 611G, 650 and 650G

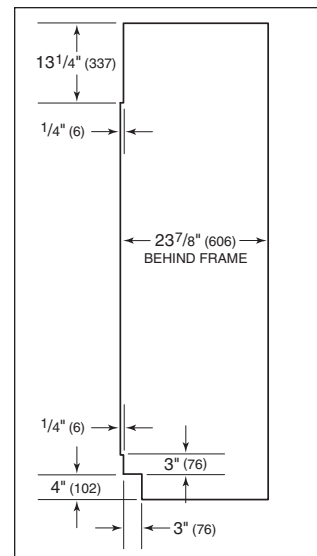

Illus. 12—Models 661, 642, 632, 685 and 695



PANEL AND HANDLE PROFILE – FRAMED APPLICATION

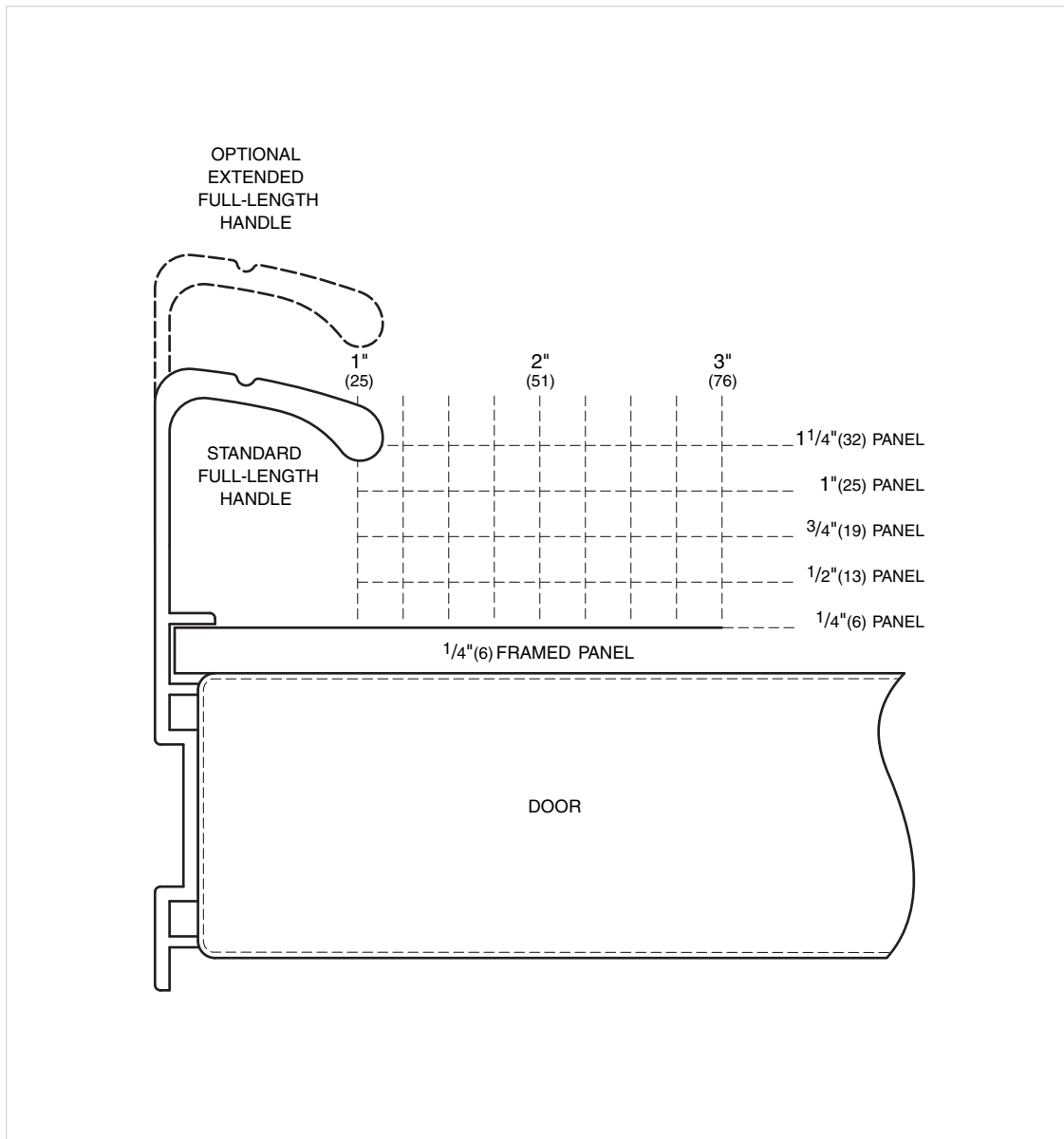

FULL-SCALE TEMPLATES

The full-scale illustrations on the following pages enable you to understand some of the unique situations you may face as you plan for the installation of the Built-In models. Use these illustrations as templates for panel and handle hardware considerations.

The full-scale illustration above shows handle placement for the framed application standard full-length handle and the optional extended full-length handle shown in the dashed line.

Dimensions in parentheses are in millimeters unless otherwise specified.



PANEL AND HANDLE PROFILE – OVERLAY AND STAINLESS STEEL APPLICATION

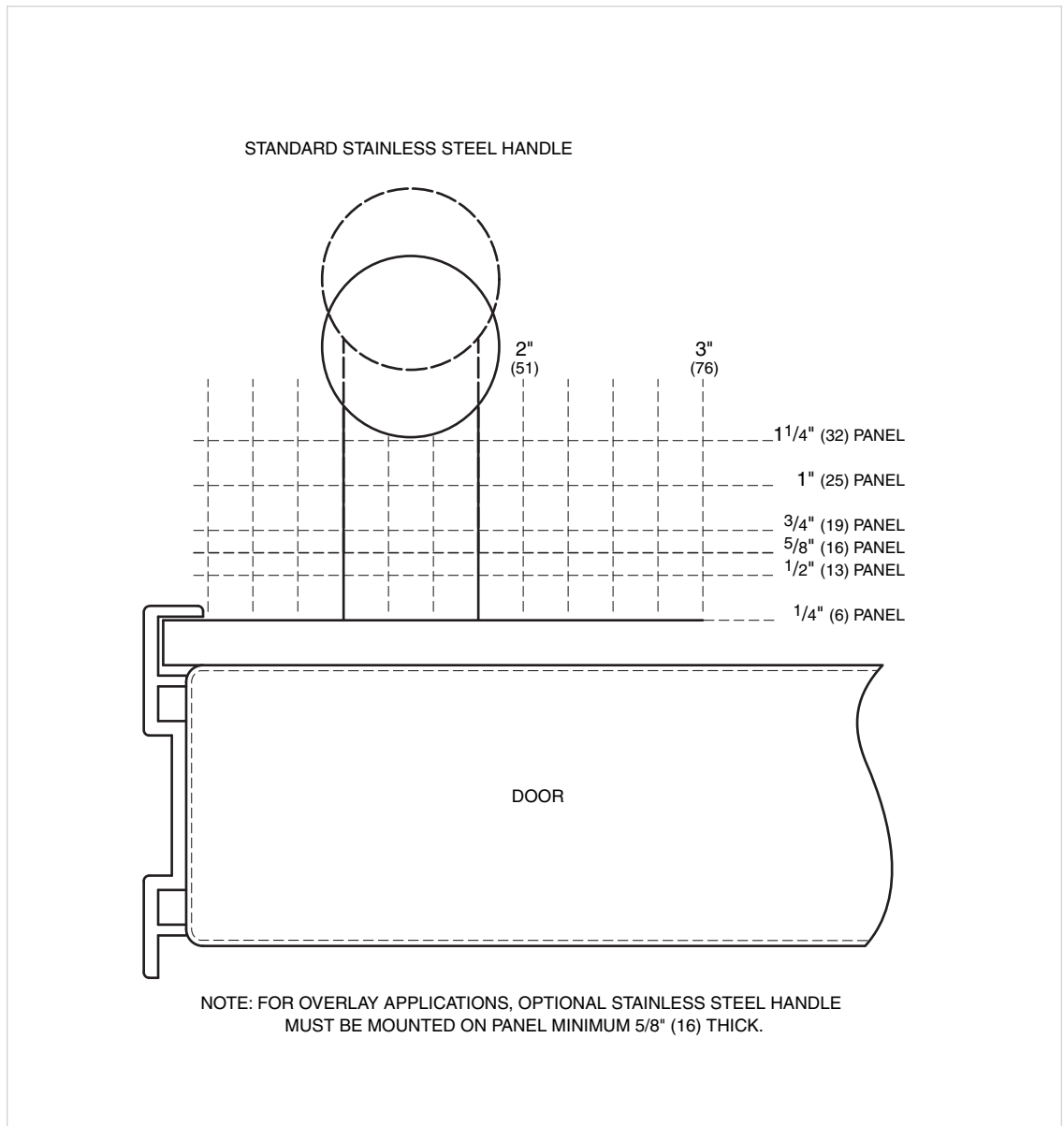

The full-scale illustration above shows handle placement for the standard stainless steel handle on the wrapped stainless steel door and on overlay panel applications shown in the dashed line.

**IMPORTANT NOTE:** For overlay applications, the panel must be a minimum of 5/8" (16) thick to support mounting the handle hardware.

For overlay applications, mount door handles close to the opening edge of the door for ease of opening.

Dimensions in parentheses are in millimeters unless otherwise specified.



PANEL AND HANDLE PROFILE - 130° DOOR OPENING (TOP VIEW)

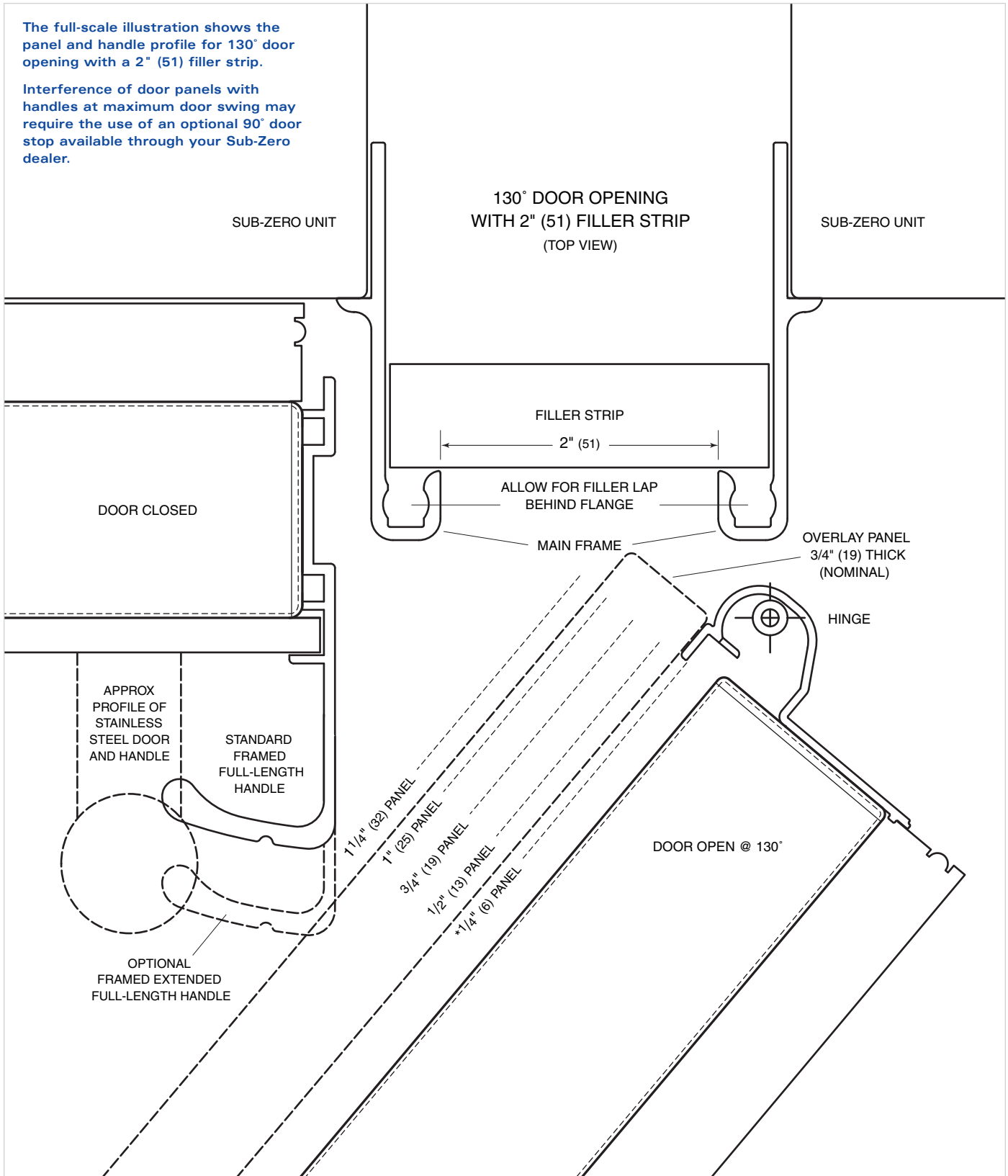

\*Approximate thickness of wrapped stainless steel door.



OVERLAY PANEL APPLICATION - 90° DOOR OPENING (TOP VIEW)

The full-scale illustration shows what considerations you need to make for overlay panel applications and how they may interact with adjacent cabinets and countertops.

NOMINAL OVERALL WIDTH OF SUB-ZERO

SUB-ZERO UNIT

23 7/8" (606) TO REAR OF SUB-ZERO

MAIN FRAME

DOOR CLOSED

- 0" (0)
- 1/4" (6)
- 1/2" (13)
- 3/4" (19)
- 1" (25)
- 1 1/4" (32)
- 1 1/2" (38)
- 1 3/4" (44)
- 2" (51)
- 2 1/4" (57)
- 2 1/2" (63)
- 2 3/4" (70)
- 3" (76)
- 3 1/4" (83)
- 3 1/2" (89)

HINGE

DOOR OPEN @ 90°

- 1 1/4" (32) PANEL
- 1" (25) PANEL
- 3/4" (19) PANEL
- 1/2" (13) PANEL
- \*1/4" (6) PANEL

OVERLAY PANEL  
3/4" (19) THICK (NOMINAL)

Dimensions in parentheses are in millimeters unless otherwise specified.

\*Approximate thickness of wrapped stainless steel door.



**INTEGRATED REFRIGERATION**

For generations, the Sub-Zero name has been synonymous with built-in refrigeration. With the Integrated line, we have taken the idea a step further—refrigerators and freezers you can hide anywhere in the house, inside the furniture or cabinetry of your choosing.

Created to blend invisibly into your home's decor, the Integrated line lets you integrate refrigeration into the kitchen, master suite, media room or workout room. Available as tall units or two-drawer base units, the Integrated line expands the possibilities for the way you shape your home.

Tall units are 80" (2032) high and offered in two different widths—27" (686) and 36" (914). The 27" (686) wide tall unit can be ordered as an all refrigerator, all freezer or combination refrigerator (upper cabinet) and freezer (drawers). The 36" (914) wide tall unit is offered as an all refrigerator or combination unit. All of these models are 24" (610) deep.

Base units are offered in the 27" (686) width only. They can be ordered as an all refrigerator, all freezer or combination refrigerator (top drawer) and freezer (bottom drawer). Base units are 34 1/2" (876) high and 24" (610) deep.

You just need to add whatever beautiful cabinetry you want to use. Optional stainless steel panels with tubular handles are offered in the classic, platinum and carbon stainless steel finishes and are ordered and shipped as sales accessories. There are some size limitations on the premium finishes of platinum and carbon stainless steel.

For information regarding specific Integrated models, refer to the illustrations in this section.

**ALL REFRIGERATOR | ALL FREEZER**

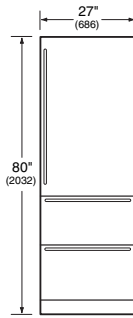

**MODEL 700TR**  
*All Refrigerator*

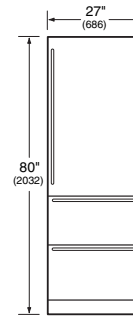

**MODEL 700TF(1)**  
*All Freezer*

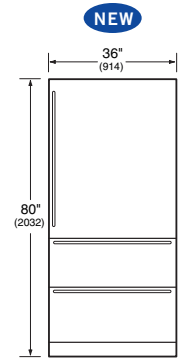

**MODEL 736TR**  
*All Refrigerator*

**OVER-AND-UNDER**

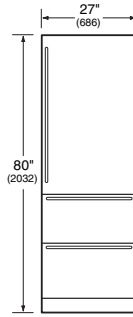

**MODEL 700TC(1)**  
*Refrigerator | Freezer*

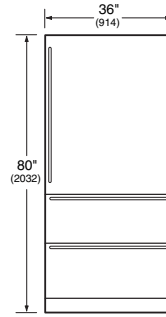

**MODEL 736TC(1)**  
*Refrigerator | Freezer*

**DRAWERS**

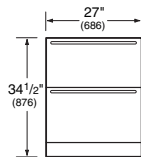

**MODEL 700BR**  
*All Refrigerator*  
*Energy Star Qualified*

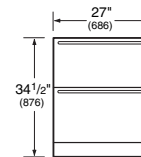

**MODEL 700BF(1)**  
*All Freezer*

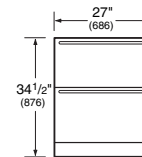

**MODEL 700BC(1)**  
*Refrigerator | Freezer*

Comprehensive installation instructions are shipped with each model. Refer to those instructions in preparing and installing all Sub-Zero products. The instructions can also be found on our website, [subzero.com](http://subzero.com).



With the installation of a harness kit, tall models are Star-K compliant to meet strict religious regulations in conjunction with specific instructions found on [www.star-k.org](http://www.star-k.org). Drawer models are Star-K certified from the factory with no extra wiring harness required. For details about the harness kit, contact your Sub-Zero dealer.



**MODEL 700TR**

ALL REFRIGERATOR

**SPECIFICATIONS**

Overall Width	<b>27" (686)</b>
Overall Height	<b>80" (2032)</b>
Overall Depth	<b>24" (610)</b>
Refrigerator Capacity	<b>15.5 cu ft (439 L)</b>
Min Height Required	<b>79 1/2" (2019)</b>
Door Swing Clearance	<b>25 1/2" (648)</b>
Specify Door Swing	<b>LH or RH</b>
Drawer Clearance	<b>19 1/2" (495)</b>
Annual Energy Usage	<b>425 kWh   \$39*</b>
Shipping Weight	<b>360 lbs (163 kg)</b>

**REFRIGERATOR FEATURES**

- Dual Refrigeration
- 2 Temperature Zones
- 3 Adjustable Glass Shelves
- 1 Stationary Shelf
- 2 Storage Drawers
- Removable Crisper Cover
- 2 Removable Drawer Dividers
- Adjustable Deli Drawer
- 3 Adjustable Door Shelves
- Adjustable Dairy Compartment
- Egg Container

**PANEL OPTIONS**

Integrated  
 Classic, platinum or carbon stainless steel finish (includes handles)\*\*

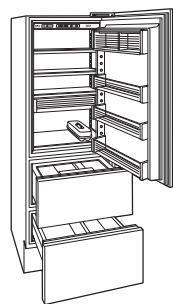

**MODEL 700TR**

**MODEL 736TR**



ALL REFRIGERATOR

**SPECIFICATIONS**

Overall Width	<b>36" (914)</b>
Overall Height	<b>80" (2032)</b>
Overall Depth	<b>24" (610)</b>
Refrigerator Capacity	<b>20.9 cu ft (592 L)</b>
Min Height Required	<b>79 1/2" (2019)</b>
Door Swing Clearance	<b>34 1/2" (876)</b>
Specify Door Swing	<b>LH or RH</b>
Drawer Clearance	<b>19 1/2" (495)</b>
Annual Energy Usage	<b>478 kWh   \$44*</b>
Shipping Weight	<b>480 lbs (218 kg)</b>

**REFRIGERATOR FEATURES**

- Dual Refrigeration
- 2 Temperature Zones
- 3 Adjustable Glass Shelves
- 1 Stationary Shelf
- 2 Storage Drawers
- Removable Crisper Cover
- 4 Removable Drawer Dividers
- Adjustable Deli Drawer
- 3 Adjustable Door Shelves
- Adjustable Dairy Compartment
- Egg Container

**PANEL OPTIONS**

Integrated  
 Classic, platinum or carbon stainless steel finish (includes handles)\*\*

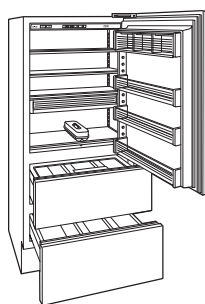

**MODEL 736TR**

**MODEL 700TF**

ALL FREEZER

**MODEL OPTIONS**

Automatic Ice Maker **700TFI**

**SPECIFICATIONS**

Overall Width	<b>27" (686)</b>
Overall Height	<b>80" (2032)</b>
Overall Depth	<b>24" (610)</b>
Freezer Capacity	<b>15.3 cu ft (433 L)</b>
Min Height Required	<b>79 1/2" (2019)</b>
Door Swing Clearance	<b>25 1/2" (648)</b>
Specify Door Swing	<b>LH or RH</b>
Drawer Clearance	<b>19 1/2" (495)</b>
Annual Energy Usage	<b>652 kWh   \$60*</b>
Shipping Weight	<b>360 lbs (163 kg)</b>

**FREEZER FEATURES**

- 1 Temperature Zone
- 3 Adjustable Glass Shelves
- 1 Stationary Shelf
- 2 Storage Drawers
- 2 Removable Drawer Dividers (700TF)
- 1 Removable Drawer Divider (700TFI)
- 4 Adjustable Door Shelves
- Automatic Defrost
- Automatic Ice Maker **Model 700TFI**

**PANEL OPTIONS**

Integrated  
 Classic, platinum or carbon stainless steel finish (includes handles)\*\*

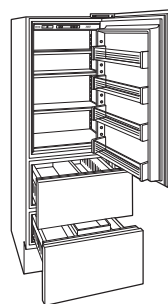

**MODEL 700TF(I)**





**MODEL 700TC**

OVER-AND-UNDER

**MODEL OPTIONS**

Automatic Ice Maker **700TCI**

**SPECIFICATIONS**

Overall Width **27" (686)**  
 Overall Height **80" (2032)**  
 Overall Depth **24" (610)**  
 Refrigerator Capacity **10.2 cu ft (289 L)**  
 Freezer Capacity **5.1 cu ft (144 L)**  
 Min Height Required **79 1/2" (2019)**  
 Door Swing Clearance **25 1/2" (648)**  
 Specify Door Swing **LH or RH**  
 Drawer Clearance **19 1/2" (495)**  
 Annual Energy Usage **540 kWh | \$49\***  
 Shipping Weight **360 lbs (163 kg)**

**REFRIGERATOR (DOOR)**

Dual Refrigeration  
**3** Adjustable Glass Shelves  
**1** Stationary Shelf  
 Adjustable Deli Drawer  
**3** Adjustable Door Shelves  
 Adjustable Dairy Compartment  
 Egg Container

**FREEZER (DRAWERS)**

**2** Removable Drawer Dividers (700TC)  
**1** Removable Drawer Divider (700TCI)  
 Automatic Defrost  
 Automatic Ice Maker (700TCI)

**PANEL OPTIONS**

Integrated  
 Classic, platinum or carbon stainless steel finish (includes handles)\*\*

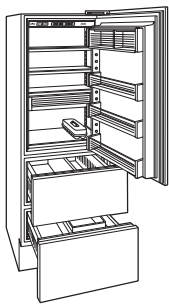

**MODEL 700TC(I)**

**MODEL 736TC**

OVER-AND-UNDER

**MODEL OPTIONS**

Automatic Ice Maker **736TCI**

**SPECIFICATIONS**

Overall Width **36" (914)**  
 Overall Height **80" (2032)**  
 Overall Depth **24" (610)**  
 Refrigerator Capacity **13.3 cu ft (377 L)**  
 Freezer Capacity **7.1 cu ft (201 L)**  
 Min Height Required **79 1/2" (2019)**  
 Door Swing Clearance **34 1/2" (876)**  
 Specify Door Swing **LH or RH**  
 Drawer Clearance **19 1/2" (495)**  
 Annual Energy Usage **569 kWh | \$52\***  
 Shipping Weight **480 lbs (218 kg)**

**REFRIGERATOR (DOOR)**

Dual Refrigeration  
**3** Adjustable Glass Shelves  
**1** Stationary Shelf  
 High-Humidity Crisper Drawer with Dividers  
**3** Adjustable Door Shelves  
 Adjustable Dairy Compartment  
 Egg Container

**FREEZER (DRAWERS)**

**2** Removable Drawer Dividers (736TC)  
**1** Removable Drawer Divider (736TCI)  
 Automatic Defrost  
 Automatic Ice Maker (736TCI)

**PANEL OPTIONS**

Integrated  
 Classic, platinum or carbon stainless steel finish (includes handles)\*\*

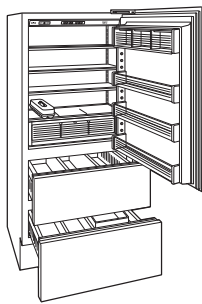

**MODEL 736TC(I)**

*\*Annual energy costs are based on 9.06 cents per kilowatt hour.*

*\*\*Optional stainless steel panels and handles are ordered and shipped as sales accessories. For additional information on panel and handle sizes and applications, check our website, subzero.com.*

**ACCESSORIES**

Contact your Sub-Zero Dealer

**Classic stainless steel front panels—platinum and carbon available in certain sizes**

**Tubular handles in classic, platinum and carbon stainless steel**

**High-humidity crisper drawer and shelf assembly\***

**Adjustable deli drawer and shelf assembly\***

**Crisper cover with lid\***

**Dozen egg container with lid\***

**Dual installation heater kit**

**Harness kit for Star-K compliance**

*\*Accessory is not available for every model.*

Dimensions in parentheses are in millimeters unless otherwise specified.



**MODEL 700BR**

REFRIGERATOR DRAWERS

*Energy Star Qualified*

**SPECIFICATIONS**

Overall Width	<b>27" (686)</b>
Overall Height	<b>34 1/2" (876)</b>
Overall Depth	<b>24" (610)</b>
Refrigerator Capacity	<b>5.3 cu ft (150 L)</b>
Min Height Required	<b>34" (864)</b>
Drawer Clearance	<b>19 1/2" (495)</b>
Annual Energy Usage	<b>337 kWh   \$31*</b>
Shipping Weight	<b>190 lbs (86 kg)</b>

**REFRIGERATOR FEATURES**

- 1 Temperature Zone
- 2 Storage Drawers
- Removable Crisper Cover
- 2 Removable Drawer Dividers

**PANEL OPTIONS**

Integrated  
 Classic, platinum or carbon stainless steel finish (includes handles)\*\*

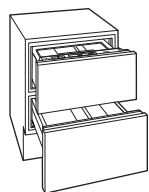

**MODEL 700BR**

**MODEL 700BF**

FREEZER DRAWERS

**MODEL OPTIONS**

Automatic Ice Maker **700BFI**

**SPECIFICATIONS**

Overall Width	<b>27" (686)</b>
Overall Height	<b>34 1/2" (876)</b>
Overall Depth	<b>24" (610)</b>
Freezer Capacity	<b>5.1 cu ft (144 L)</b>
Min Height Required	<b>34" (864)</b>
Drawer Clearance	<b>19 1/2" (495)</b>
Annual Energy Usage	<b>488 kWh   \$45*</b>
Shipping Weight	<b>190 lbs (86 kg)</b>

**FREEZER FEATURES**

- 1 Temperature Zone
- 2 Storage Drawers
- 2 Removable Drawer Dividers (700BF)
- 1 Removable Drawer Divider (700BFI)
- Automatic Defrost
- Automatic Ice Maker (700BFI)

**PANEL OPTIONS**

Integrated  
 Classic, platinum or carbon stainless steel finish (includes handles)\*\*

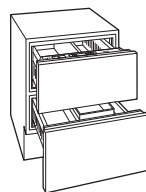

**MODEL 700BF(I)**

**MODEL 700BC**

REFRIGERATOR | FREEZER DRAWERS

**MODEL OPTIONS**

Automatic Ice Maker **700BCI**

**SPECIFICATIONS**

Overall Width	<b>27" (686)</b>
Overall Height	<b>34 1/2" (876)</b>
Overall Depth	<b>24" (610)</b>
Refrigerator Capacity	<b>2.9 cu ft (82 L)</b>
Freezer Capacity	<b>2.1 cu ft (59 L)</b>
Min Height Required	<b>34" (864)</b>
Drawer Clearance	<b>19 1/2" (495)</b>
Annual Energy Usage	<b>448 kWh   \$41*</b>
Shipping Weight	<b>190 lbs (86 kg)</b>

**FEATURES**

- 2 Temperature Zones
- 2 Storage Drawers
- Removable Crisper Cover
- 1 Removable Drawer Divider (700BC)
- Automatic Ice Maker (700BCI)

**PANEL OPTIONS**

Integrated  
 Classic, platinum or carbon stainless steel finish (includes handles)\*\*

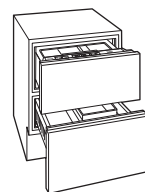

**MODEL 700BC(I)**

*\*Annual energy costs are based on 9.06 cents per kilowatt hour.*

*\*\*Optional stainless steel panels and handles are ordered and shipped as sales accessories. For additional information on panel and handle sizes and applications, check our website, subzero.com.*

Dimensions in parentheses are in millimeters unless otherwise specified.

**ACCESSORIES**  
Contact your Sub-Zero Dealer

- Front panels in classic, platinum and carbon stainless steel**
- Tubular handles in classic, platinum and carbon stainless steel**
- Crisper cover with lid\***
- Dozen egg container with lid\***
- Dual installation heater kit**

*\*Accessory is not available for every model.*



## INTEGRATED FEATURES

All Integrated models accept wood or stainless steel panels. The optional stainless steel panels and handles are available in classic, platinum and carbon stainless steel finishes at the 80" (2032) height, and only classic stainless steel at the 84" (2134) height. Stainless steel panels are ordered and shipped as sales accessories.

**Functional Design.** These models can be placed anywhere in the home. Think about "point-of-use refrigeration" when planning where to place your units.

**Integrated Design.** All Sub-Zero models are 24" (610) deep. Tall Integrated units are 80" (2032) high and are offered in two different widths—27" (686) and 36" (914). All base units are 27" (686) wide and 34 1/2" (876) high.

**Microprocessor.** The "brains" of the Integrated units, this computer allows the best in temperature control, efficiency and food preservation.

**Temperature Zones.** On tall refrigerator and combination units, you have the flexibility of having two temperatures within the same unit.

**Automatic Defrost.** Depending on usage and exact climate, the Integrated unit will adapt to the unique situation and adjust accordingly to offer greater efficiency. Integrated freezer and combination units have an automatic defrost system.

**Kickplate.** The adjustable solid kickplate meets standards of the American Institute of Architects. The toe kick area for a solid, decorative kickplate is 4" (102) high by 3" (76) deep. You can show a 10" (254) toe kick, but you cannot cover the louvers of the kickplate. If you choose, the kickplate can be painted.

**Front Venting.** All models have the mechanical equipment in an area below the lower drawer. The lower drawer panel can extend to cover these louvers, but a removable decorative kickplate cannot cover the fins.

**Lighting.** Flat to the ceiling, superior lighting provides white, efficient light in cabinet and drawer units.

**Door/Drawer Alarm.** When activated, if your door or drawer is accidentally left open for more than 30 seconds, an audible alarm will sound.

**Spill-Proof Shelves.** The cabinet section of the tall units features adjustable spill-proof one-piece glass shelves that are easily removed for cleaning.

**Dairy Shelf.** This magnetically sealed compartment is fully adjustable on the tall refrigerator and combination units.

**Crisper Cover.** On the tall and base refrigerator units and the base combination unit, a removable crisper cover is offered for one of the drawer sections.

**Deli Drawer.** Smaller items are not lost in this handy feature of the Models 700TR and 700TC(I). Available as a sales accessory for Model 736TC(I).

**Crisper—Model 736TC(I).** Model 736TC(I) is equipped with a sealed crisper. It is large and deep, with smooth sides for easy cleaning. The space features removable dividers.

**Egg Container.** You can store a dozen eggs in this removable egg container with lid in the tall refrigerator and tall combination units.

**Ice Maker.** An automatic ice maker, providing crescent-shaped ice, is available as an option on the tall and base freezers as well as the tall and base combination units. This optional equipment must be factory installed.

**Door Swing.** You can choose left or right door swing on the tall units. This option must be ordered when requesting the unit. You cannot reverse the door in the field.

**Dual-Action Hinge.** An exclusive dual-action hinge is featured on all of the tall units, allowing for a fully integrated look.

**Door Stop.** On all of the tall units, a 90° door stop is built in to the hinge. Normal door swing is 105°.

**Temperature Zones.** With the microprocessor in the Integrated models, you have the capability of setting different optimum temperatures.

## SUB-ZERO WARRANTY

Sub-Zero products are covered by a two, five and twelve year residential warranty (exclusions apply). See warranty details at the end of this guide.

## TEMPERATURE ZONES

**Model 700BR – One zone,  
34°F (1°C) to 45°F (7°C)**

**Models 700TR and 736TR –  
Two zones, 34°F (1°C) to 45°F (7°C)**

**Models 700BF(I) and 700TF(I) –  
One zone, -5°F (-21°C) to +5°F (-15°C)**

**Model 700TF(I) – One zone,  
-5°F (-21°C) to +5°F (-15°C)**

**Model 700BC(I) – Two zones,  
34°F (1°C) to 45°F (7°C) top drawer;  
-5°F (-21°C) to +5°F (-15°C) bottom  
drawer**

**Models 700TC(I) and 736TC(I) –  
Two zones, 34°F (1°C) to 45°F (7°C)  
cabinet; -5°F (-21°C) to +5°F (-15°C)  
drawers**

## PLANNING INFORMATION

Before moving the Integrated unit into place, be sure that the finished opening dimensions, electrical and plumbing locations and minimum door and drawer clearances are accurate. Refer to the Installation Specifications illustration for your model on the following pages. Be sure your installer has this information before finishing work is completed.

Integrated models without an automatic ice maker will not require the plumbing connections shown in the illustrations.

The height of the tall unit is set at 80" (2032). You can allow the top of the door panel to exceed this dimension with caution. If you are working with 84" (2134) or 96" (2438) neighboring panels, you can utilize door panels to match this height. Other critical dimensions regarding the door swing, drawer openings and toe kick clearance are noted in the Overall Dimensions illustrations on the following pages. Also refer to the full-scale illustrations at the end of this section for specifics on door openings and other specifications.

**IMPORTANT NOTE:** The anti-tip bracket must be installed to prevent the unit from tipping forward.

## ELECTRICAL REQUIREMENTS

A 115 V AC, 60 Hz, 15 amp circuit breaker and electrical supply are required. A separate circuit, servicing each base and tall unit, is required.

All Sub-Zero Integrated models are equipped with a power supply cord with a 3-prong grounding plug, which must be plugged into a mating 3-prong grounding-type wall receptacle. Follow the National Electrical Code and local codes and ordinances when installing the receptacle.

**IMPORTANT NOTE:** The electrical outlet must be placed so the grounding prong is to the right of the thinner blades. The outlet must be flush with the back wall. Refer to the Installation Specifications illustration for your model for exact placement.

**IMPORTANT NOTE:** A ground fault circuit interrupter (GFCI) is not recommended and may cause interruption of operation.

## ⚠ WARNING

**Do not use an extension cord or 2-prong adapter. Electrical ground is required.**

**Do not under any circumstances remove the power supply cord ground prong.**

## PLUMBING CONSIDERATIONS

For models with an automatic ice maker, rough in the water supply line. Connect a 1/4" OD copper line to the house supply, being sure to use an easily accessible shut-off valve between the supply and the unit. This shut-off valve should not be installed behind the unit.

Do not use self-piercing valves. A saddle valve kit (4200880) is available from your Sub-Zero dealer. An in-line filter is required when water conditions have a high sediment content. The ice maker operates on constant water pressure between 20 psi (1.4 bar) and 100 psi (6.9 bar).

**IMPORTANT NOTE:** In some cases, a reverse osmosis water filter system may not be able to maintain the minimum pressure consistently.

The Installation Specifications illustration for your model on the following pages shows the precise placement of the water line. When routing the water through the side walls, you must place the water line within 1/2" (13) of the floor and as close as possible to the back wall. The line must be routed around the anti-tip bracket so it clears the bracket and the leveling feet of the unit as shown in the top view of the illustration. Regardless of the routing, allow for 27" (686) of excess copper tubing to remain outside the wall or floor for easy connection to the unit.

**IMPORTANT NOTE:** Do not route water supply line in front of the compressor tray. The tray must be slid forward for service.



OVERALL DIMENSIONS

Models 700TR, 700TF(I) and 700TC(I)

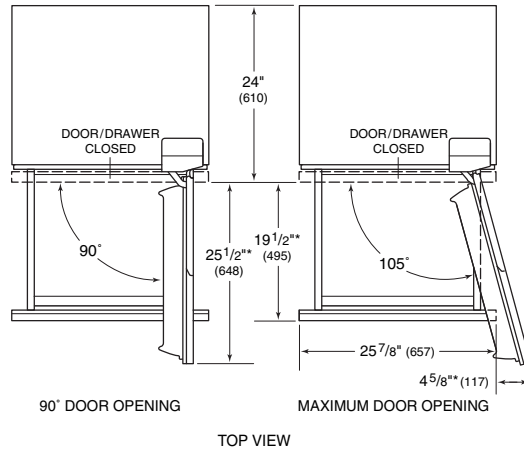
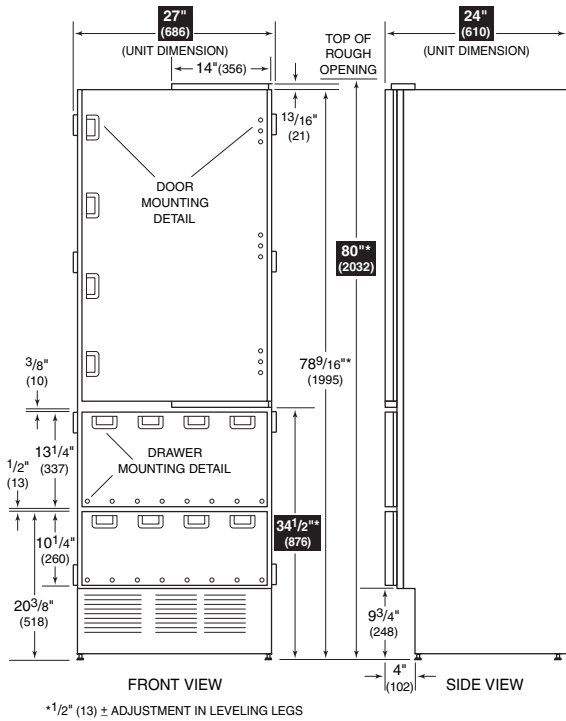

ALL REFRIGERATOR  
 ALL FREEZER

**Model 700TR**  
 All Refrigerator

**Model 700TF**  
 All Freezer

**Model 700TFI**  
 All Freezer  
 with Ice Maker

OVER-AND-UNDER  
 Refrigerator / Freezer

**Model 700TC**

**Model 700TCI**  
 with Ice Maker

INSTALLATION  
 SPECIFICATIONS

Models 700TR, 700TF(I) and 700TC(I)

Models without an ice maker will not  
 require the water line connection.

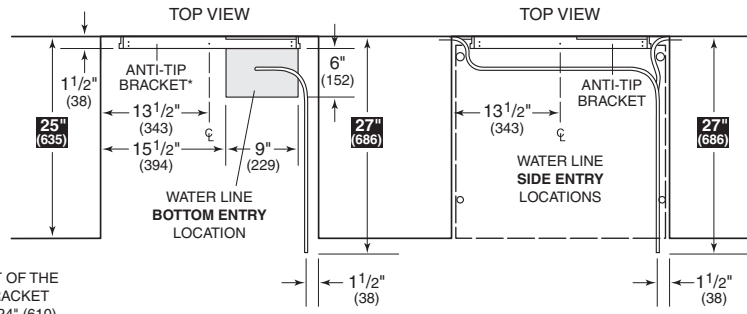

\*PLACEMENT OF THE ANTI-TIP BRACKET SHOULD BE 24" (610) FROM THE FRONT OF THE UNIT WITHOUT PANELS TO THE BACK OF THE ANTI-TIP BRACKET.

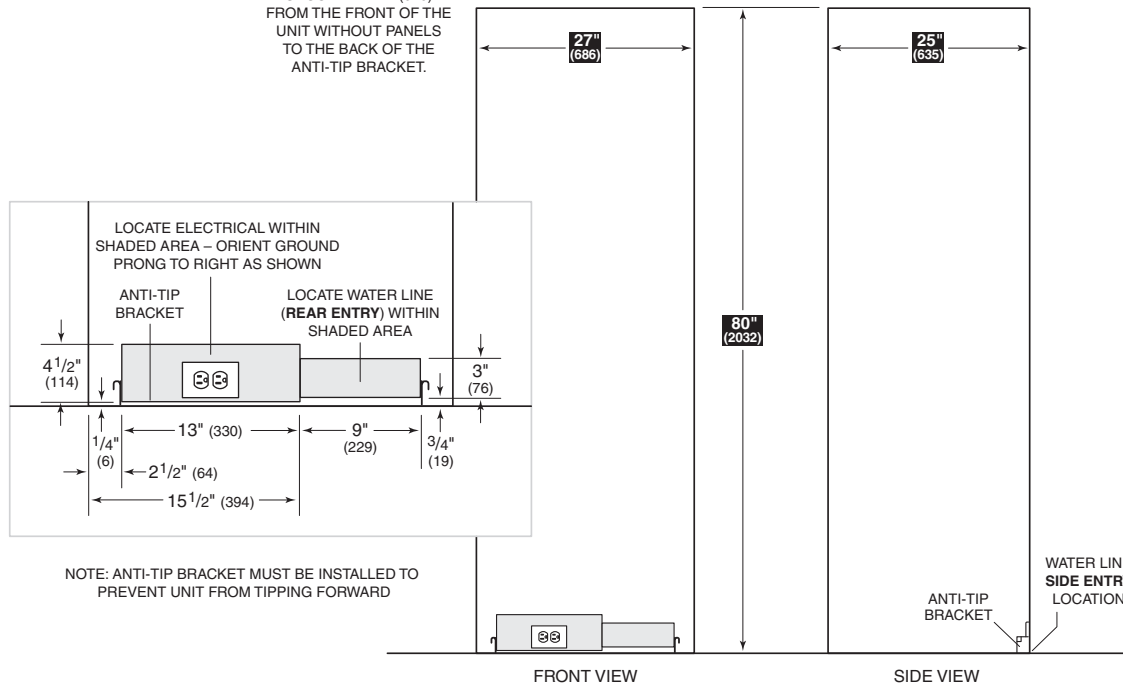

NOTE: ANTI-TIP BRACKET MUST BE INSTALLED TO PREVENT UNIT FROM TIPPING FORWARD

MODEL 700TR  
 MODEL 700TF(I)  
 MODEL 700TC(I)

**Overall Dimensions**

Width 27" (686)  
 Height 80" (2032)  
 Depth 24" (610)

**Finished Opening**

Width 27" (686)  
 Height 80" (2032)  
 Depth 25" (635)\*

\*The depth of the unit is 24" (610) from the front of the unit to its back. Your design may necessitate moving the unit back or cabinets forward to achieve a flush fit. This will require a minimum rough opening depth of 25" (635).

Refer to installation instructions shipped with each Wolf product for detailed specifications.





OVERALL DIMENSIONS

Models 700BR, 700BF(I) and 700BC(I)

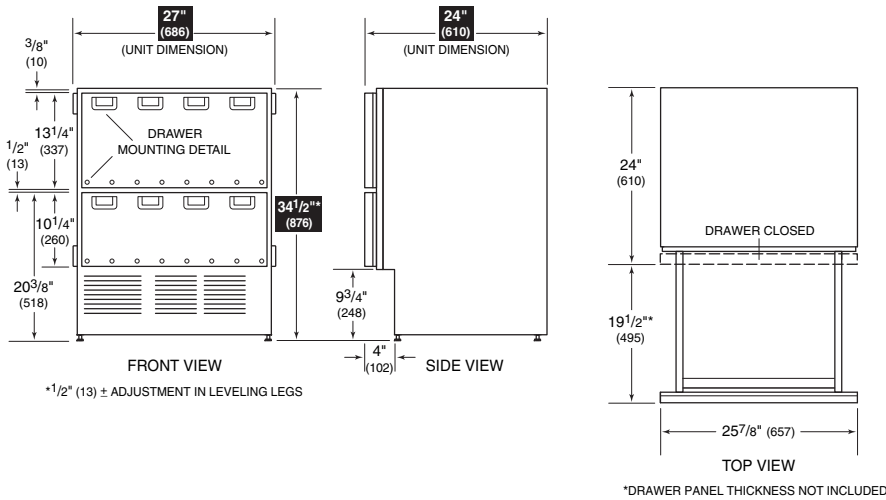

DRAWERS

Model 700BR  
All Refrigerator

Model 700BF  
All Freezer

Model 700BF(I)  
All Freezer  
with Ice Maker

Model 700BC  
Refrigerator / Freezer

Model 700BC(I)  
Refrigerator / Freezer  
with Ice Maker

INSTALLATION SPECIFICATIONS

Models 700BR, 700BF(I) and 700BC(I)

Models without an ice maker will not require the water line connection.

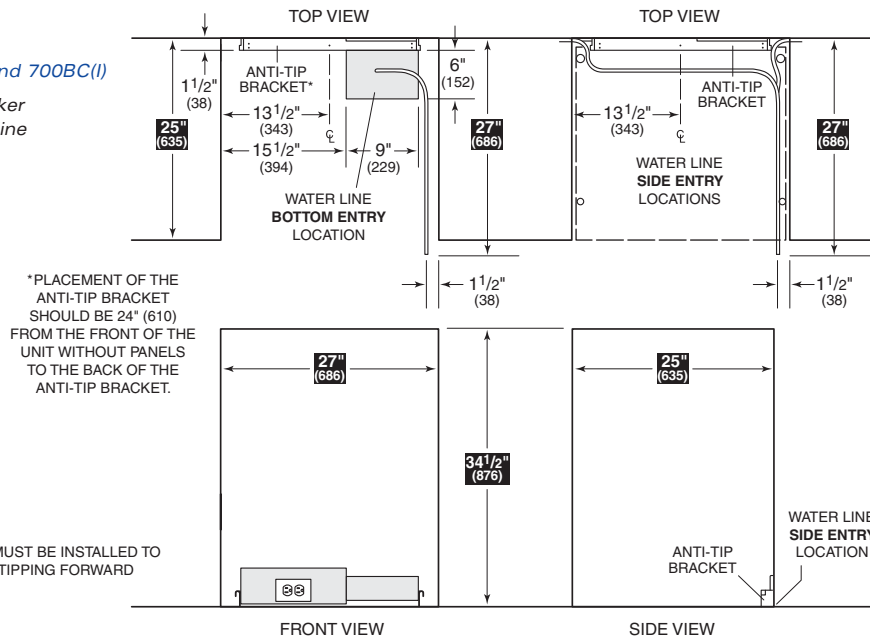

MODEL 700BR  
MODEL 700BF(I)  
MODEL 700BC(I)

Overall Dimensions

Width 27" (686)  
Height 34 1/2" (876)  
Depth 24" (610)

Finished Opening

Width 27" (686)  
Height 34 1/2" (876)  
Depth 25" (635)\*

\*The depth of the unit is 24" (610) from the front of the unit to its back. Your design may necessitate moving the unit back or cabinets forward to achieve a flush fit. This will require a minimum rough opening depth of 25" (635).

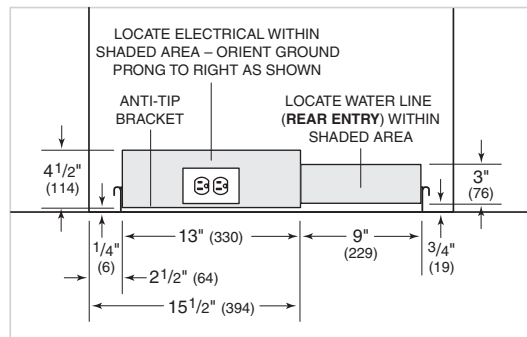

Refer to installation instructions shipped with each Wolf product for detailed specifications.



**CABINETRY APPLICATIONS**

Integrated refrigeration is compatible with virtually any style and look of cabinetry. The models can be used with framed as well as frameless cabinets. Because of the precise application and the look you may want to achieve, there are important questions you need to answer before ordering panels for the doors/drawers. As you look at styles of cabinets, keep some important facts in mind:

**IMPORTANT NOTE:** The depth of each Integrated model is 24" (610) from the front of the unit to its back. You **must** allow for the thickness of the panel you are applying when planning for the finished rough opening depth if you want the front panel to be flush with surrounding cabinetry. You **must** move the unit back into drywall or bring the cabinets forward to achieve a flush fit.

The height of the door panel can grow beyond 45<sup>3</sup>/<sub>8</sub>" (1153) and exceed the 80" (2032) overall height as long as you stay below the recommended door panel weight limit.

The toe kick clearance can vary with the height of the lower drawer panel; the maximum panel height is 16<sup>11</sup>/<sub>16</sub>" (424). You must keep a minimum space of 4" (102) clear below the bottom edge of the lower drawer panel so the unit can be properly vented.

We recommend using D-style handles. For the cabinet door, handles must be located near the edge of the panel opposite the hinge, centered top to bottom. Locate handles in the top center area of the drawer panels.

**IMPORTANT NOTE:** The inside edges of the rough opening, as well as the sides and a portion of the backside of the decorative panels will need to be finished, as they will be exposed when the doors are open.

**FRAMED CABINETRY**

Framed cabinetry applications present you with different questions to address. The illustrations below show common applications of framed cabinetry. These are not meant to be the only alternatives, but are suggestions from designers around the country. Also refer to the full-scale illustrations at the end of this section for specifics on door openings.

NOTE: In the illustrations below, the first width dimension shown is for 27" (686) wide units and the second dimension is for 36" (914) wide units.

PANEL REQUIREMENTS

Door and drawer panels must be a minimum of 5/8" (16) thick.

The door panel cannot exceed 40 lbs (18 kg) and each drawer panel must not exceed 12 lbs (5 kg) for 27" (686) wide units. For 36" (914) wide units, the door panel weight limit is 53 lbs (24 kg) and 16 lbs (7 kg) for each drawer panel.

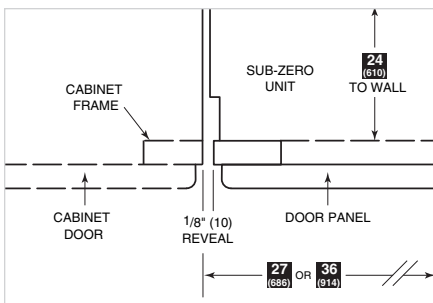

Traditional frame - full overlay (top view)

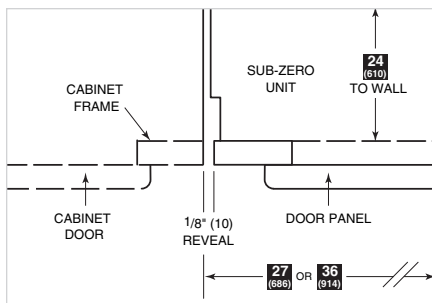

Traditional frame - standard overlay (top view)

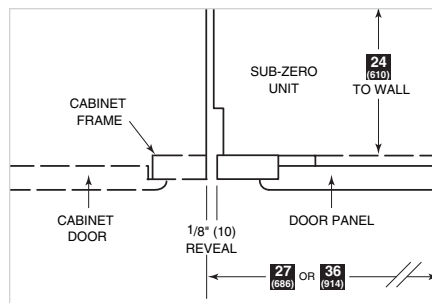

Traditional frame - 3/8" (10) offset (top view)





**FRAMED CABINETRY –  
BEADED INSET APPLICATION**

The illustration below shows a 27" (686) wide integrated base or tall unit installed within a framed cabinetry, beaded inset application. Review, giving particular attention to the overall panel specifications. Also refer to the full-scale illustrations at the end of this section for specifics on door openings.

27" (686)  
WIDE MODELS

**Installation of a  
27" (686) wide  
Integrated base or  
tall unit within  
framed cabinetry.**

*\*Dimensions may vary.*

*Dimensions are based on a 1/8" (3) reveal. A reveal of up to 1/4" (6) is possible, but panel dimensions need to be adjusted accordingly.*

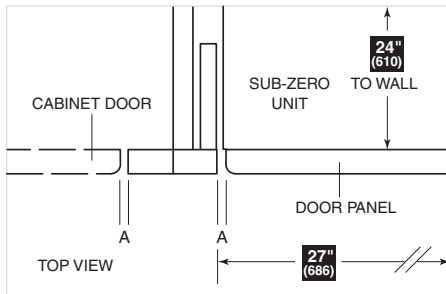

- A) ALL REVEALS ARE 1/8" (3)
- B) DRAWER RAILS ARE ATTACHED TO DRAWER FRONTS
- C) BOTTOM RAIL MUST BE REMOVABLE

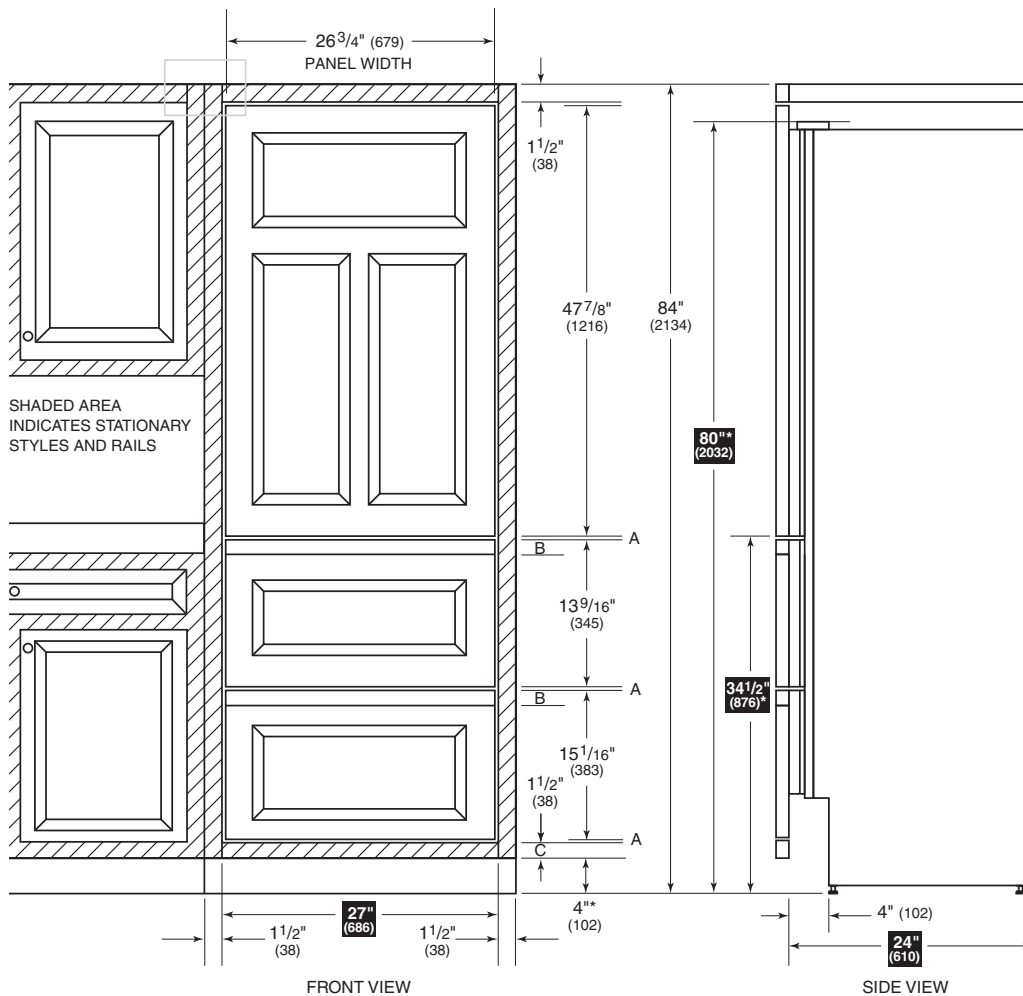

Dimensions are in inches with millimeters in parentheses unless otherwise specified.



### FRAMED CABINETS – BEADED INSET APPLICATION

The illustration below shows 36" (914) wide Integrated tall unit installed within a framed cabinetry, beaded inset application. Review, giving particular attention to the overall panel specifications. Also refer to the full-scale illustrations at the end of this section for specifics on door openings.

36" (914)  
WIDE MODELS

**Installation of a 36" (914) wide Integrated tall unit within framed cabinetry.**

*\*Dimensions may vary.*

*Dimensions are based on a 1/8" (3) reveal. A reveal of up to 1/4" (6) is possible, but panel dimensions need to be adjusted accordingly.*

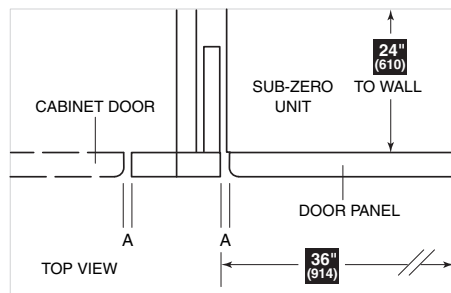

- A) ALL REVEALS ARE 1/8" (3)
- B) DRAWER RAILS ARE ATTACHED TO DRAWER FRONTS
- C) BOTTOM RAIL MUST BE REMOVABLE

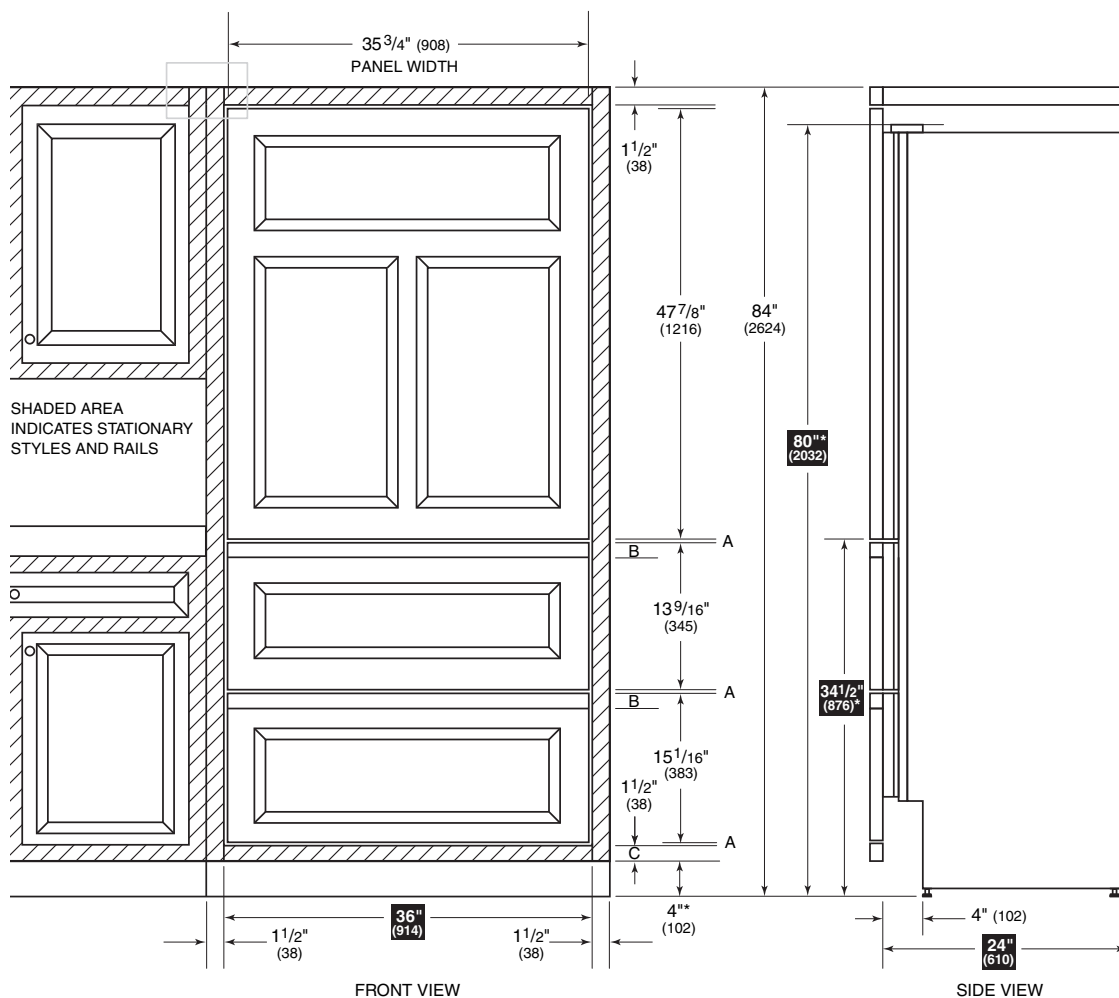

Dimensions in parentheses are in millimeters unless otherwise specified.



**FRAMELESS CABINETRY**

The illustrations show hypothetical installations of Integrated base or tall units within frameless cabinetry. Review, giving particular attention to the overall panel specifications. Also refer to the full-scale illustrations at the end of this section for specifics on door openings.

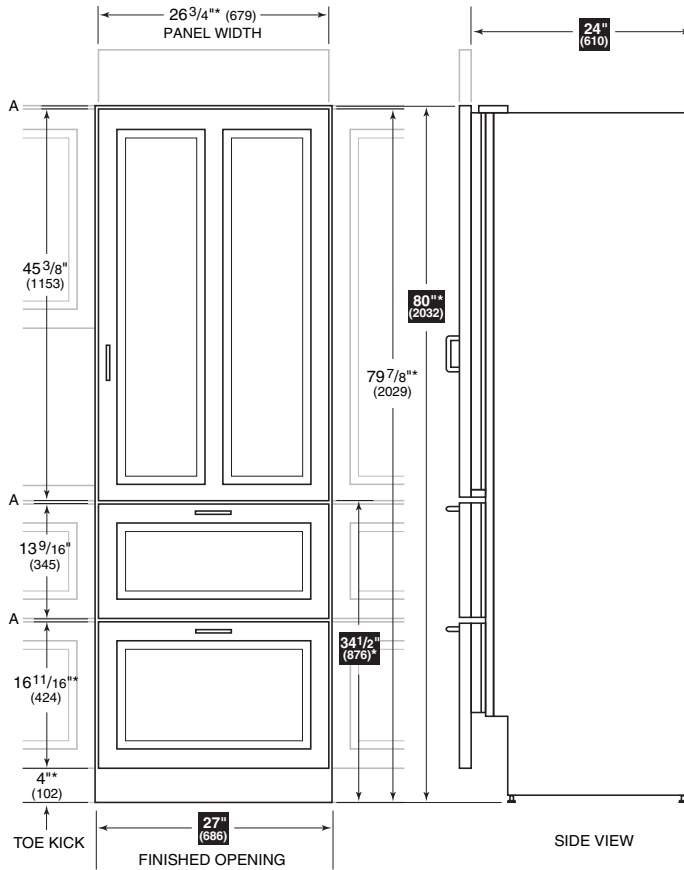

A) ALL REVEALS ARE 1/8" (3)

27" (686)  
WIDE MODELS

**Installation of a 27" (686) wide Integrated base or tall unit within frameless cabinetry.**

*\*Dimensions may vary. Dimensions are based on a 1/8" (3) reveal. A reveal of up to 1/4" (6) is possible, but panel dimensions need to be adjusted accordingly.*

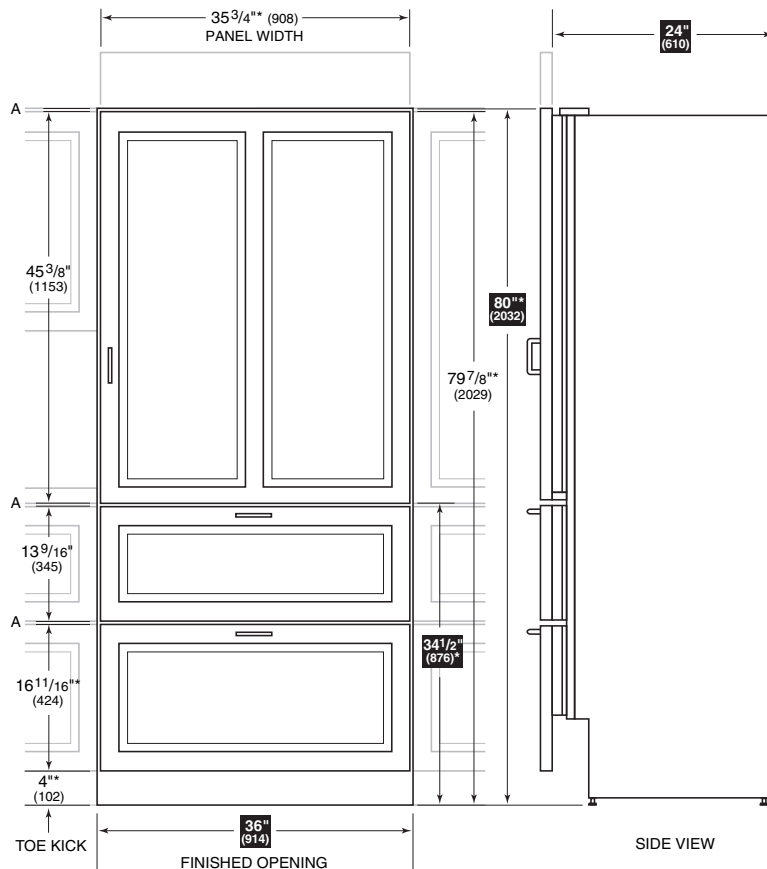

A) ALL REVEALS ARE 1/8" (3)

36" (914)  
WIDE MODELS

**Installation of a 36" (914) wide Integrated tall unit within frameless cabinetry.**

*\*Dimensions may vary. Dimensions are based on a 1/8" (3) reveal. A reveal of up to 1/4" (6) is possible, but panel dimensions need to be adjusted accordingly.*

To install integrated panels, see the detailed procedures outlined in the Sub-Zero Integrated Installation Instructions.



PANEL CONSIDERATIONS

The illustrations below provide panel width dimensions for installation of a single tall unit, 27" (686) and 36" (914) wide models.

Illustrations on the following page provide panel width dimensions for installing two tall units side by side, 27" (686) wide models and 36" (914) wide models.

**IMPORTANT NOTE:** The depth of each Integrated model is 24" (610) from the front of the unit to its back. You **must** allow for the thickness of the panel you are applying when planning for the finished rough opening depth if you want the front panel to be flush with surrounding cabinetry. You may have to move the unit back into drywall or bring the cabinets forward to achieve a flush fit.

PANEL REQUIREMENTS

Door and drawer panels must be a minimum of 5/8" (16) thick.

The door panel cannot exceed 40 lbs (18 kg) and each drawer panel must not exceed 12 lbs (5 kg) for 27" (686) wide units. For 36" (914) wide units, the door panel weight limit is 53 lbs (24 kg) and 16 lbs (7 kg) for each drawer panel.

27" (686) WIDE MODELS

Panel width dimensions for installation of a 27" (686) wide tall unit.

Dimensions are based on a 1/8" (3) reveal. A reveal of up to 1/4" (6) is possible, but panel dimensions need to be adjusted accordingly.

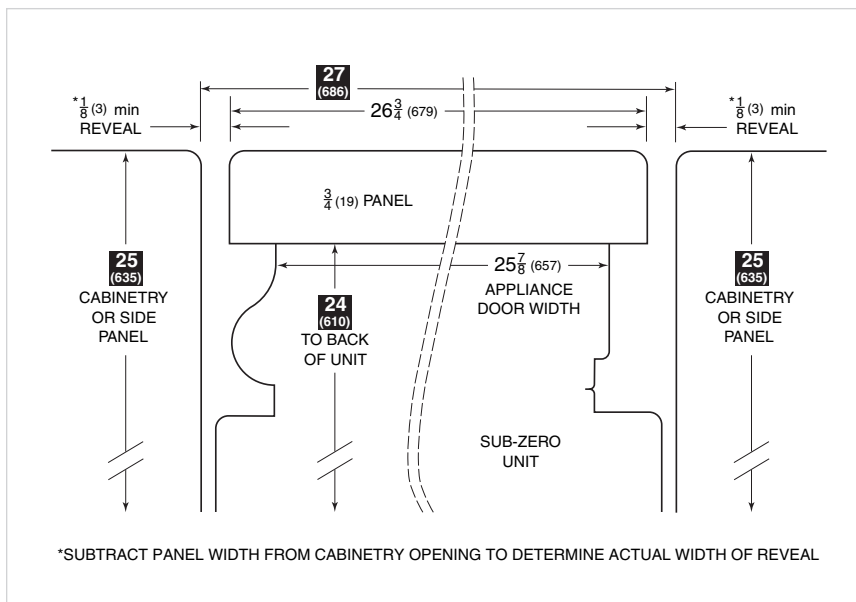

36" (914) WIDE MODELS

Panel width dimensions for installation of a 36" (914) wide tall unit.

Dimensions are based on a 1/8" (3) reveal. A reveal of up to 1/4" (6) is possible, but panel dimensions need to be adjusted accordingly.

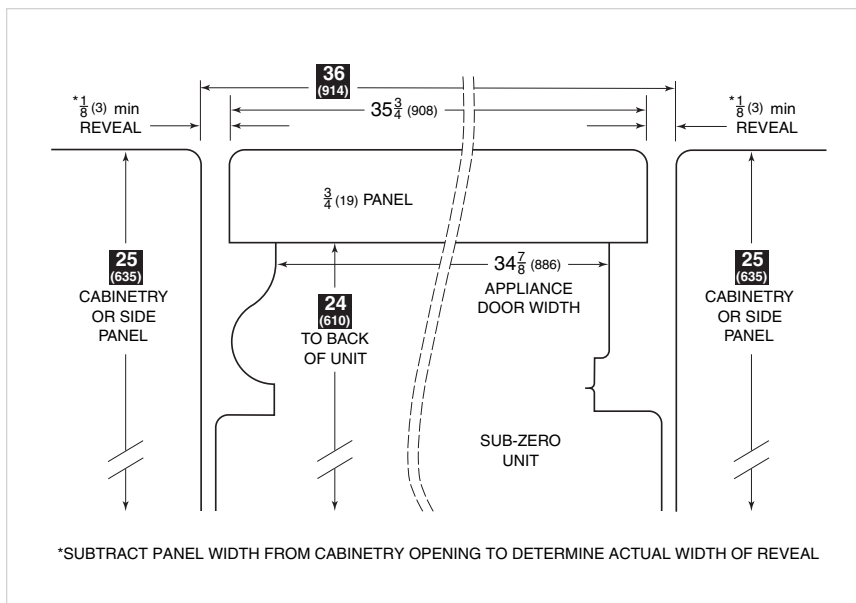

Dimensions are in inches with millimeters in parentheses unless otherwise specified.



PANEL CONSIDERATIONS

**⚠ CAUTION**  
 As the reveal between cabinets and the Integrated unit decreases, the potential exists for severe finger pinching or crushing if a hand or fingers are placed in the opening when the door is closing.

**⚠ CAUTION**  
 When 3/4" (19) or thicker panels are used and a reveal less than 1/4" (6) is maintained, the door panels may cause damage to the Sub-Zero unit when the door is open at the maximum 105° stop. You should use the built-in 90° stop to prevent damage.

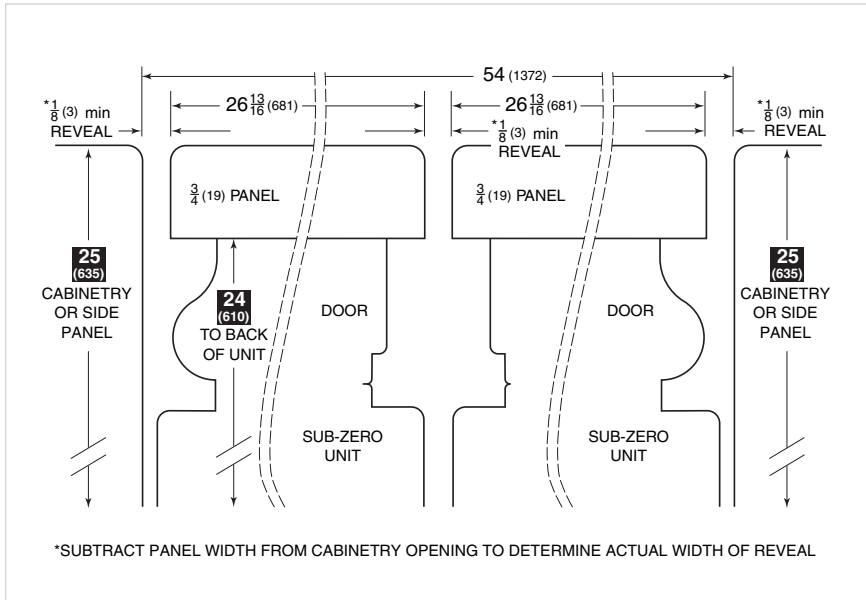

27" (686)  
 WIDE MODELS

Panel width dimensions for installation of two 27" (686) wide tall units side by side.

Dimensions are based on a 1/8" (3) reveal. A reveal of up to 1/4" (6) is possible, but panel dimensions need to be adjusted accordingly.

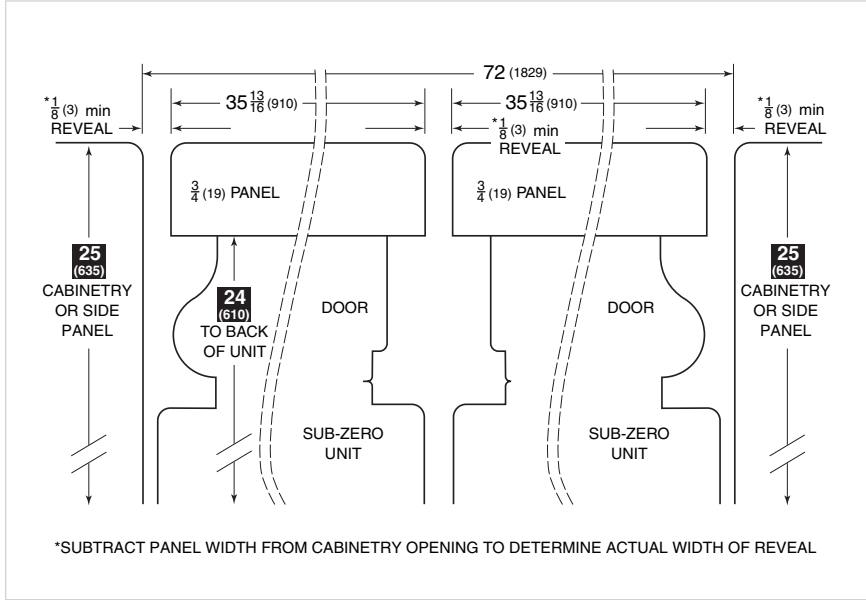

36" (914)  
 WIDE MODELS

Panel width dimensions for installation of two 36" (914) wide tall units side by side.

Dimensions are based on a 1/8" (3) reveal. A reveal of up to 1/4" (6) is possible, but panel dimensions need to be adjusted accordingly.

To install integrated panels, see the detailed procedures outlined in the Sub-Zero Integrated Installation Instructions.



INSTALLATION OPTIONS

The illustrations show some typical installations and their dimension considerations. The depth dimension in the illustrations may vary depending on cabinet styles, treatment of countertops or other design options.

**IMPORTANT NOTE:** The depth of each Integrated model is 24" (610) from the front of the unit to its back. Your design may necessitate moving the unit back or cabinets forward to achieve a flush fit. This will require a minimum rough opening depth of 25" (635). Refer to the illustrations.

**NOTE:** In the Installation Options illustrations, the first width dimension shown is for 27" (686) wide units and the second dimension is for 36" (914) wide units.

DUAL INSTALLATIONS

If two or more Integrated models are installed side by side where there is 2" (51) or less of space between the units, a heater kit is recommended—TTDUAL for two tall units installed side by side and BBDUAL for two base units or a base unit and a tall unit installed side by side. These optional components are available through your Sub-Zero dealer.

ACCESSORIES

Optional accessories are available through your Sub-Zero dealer. To obtain local dealer information, visit the Showroom Locator section of our website, subzero.com.

Dimensions are in inches with millimeters in parentheses unless otherwise specified.

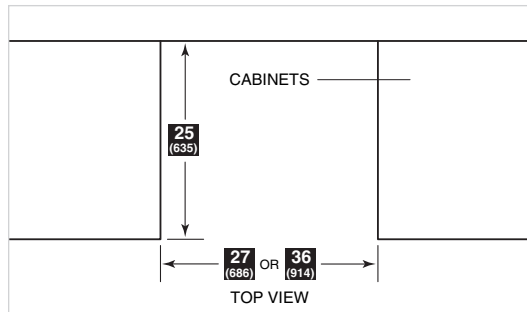

Installation without side panels

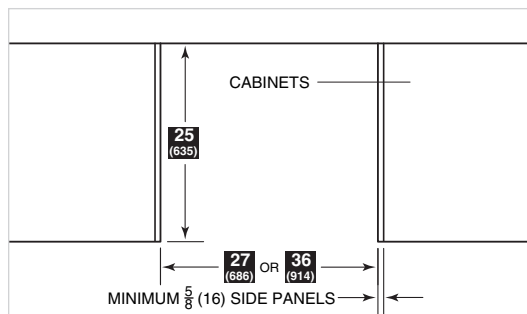

Installation with side panels

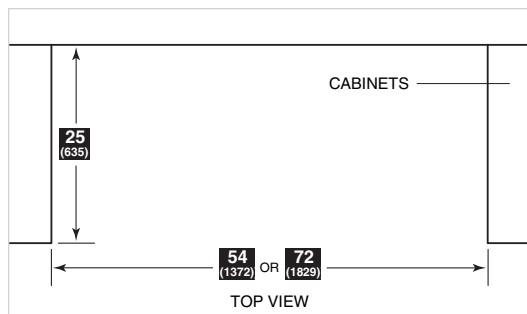

Installation of two units side by side

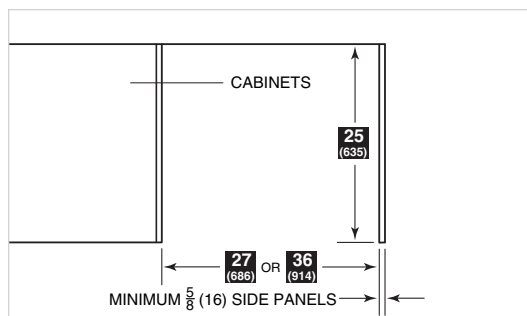

Installation at end of run



**DOOR PANEL HEIGHT**

The height of the door panel can grow beyond 45<sup>3</sup>/<sub>8</sub>" (1153) and exceed the 80" (2032) overall height, as long as you stay below the recommended door panel weight limit.

The top illustration shows how the panel may grow and what you need to consider doing to finish the area in back of the door panel.

**IMPORTANT NOTE:** The valance you use to finish the area behind the door panel must stay behind the front plane of the finished molding.

**TOE KICK CLEARANCE**

The toe kick clearance can vary with the height of the lower drawer panel; the maximum panel height is 16<sup>11</sup>/<sub>16</sub>" (424).

**IMPORTANT NOTE:** You must keep a minimum space of 4" (102) clear below the bottom edge of the lower drawer panel so the unit can be properly vented. In addition, any decorative base molding must be removable for possible servicing and cleaning of the condenser.

The bottom illustration shows the area below the lower drawer where the operating mechanical equipment of the Integrated unit is housed.

PANEL REQUIREMENTS

Door and drawer panels must be a minimum of 5/8" (16) thick.

The door panel cannot exceed 40 lbs (18 kg) and each drawer panel must not exceed 12 lbs (5 kg) for 27" (686) wide units. For 36" (914) wide units, the door panel weight limit is 53 lbs (24 kg) and 16 lbs (7 kg) for each drawer panel.

UPPER VALANCE  
*Tall Models*

The depth of each Integrated model is 24" (610) from the front of the unit to its back. Your design may necessitate moving the unit back or cabinets forward to achieve a flush fit. This will require a minimum rough opening depth of 25" (635).

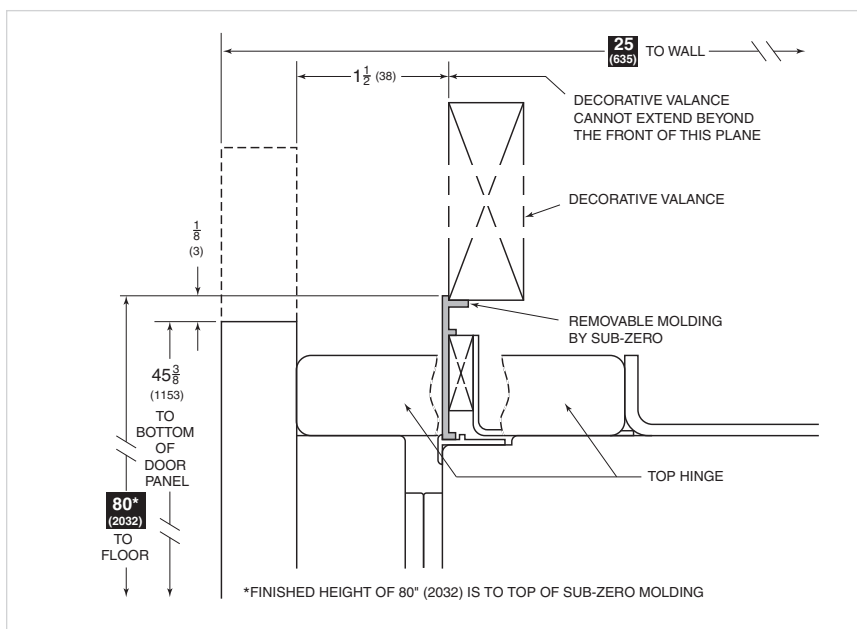

KICKPLATE AREA  
*Base and Tall Models*

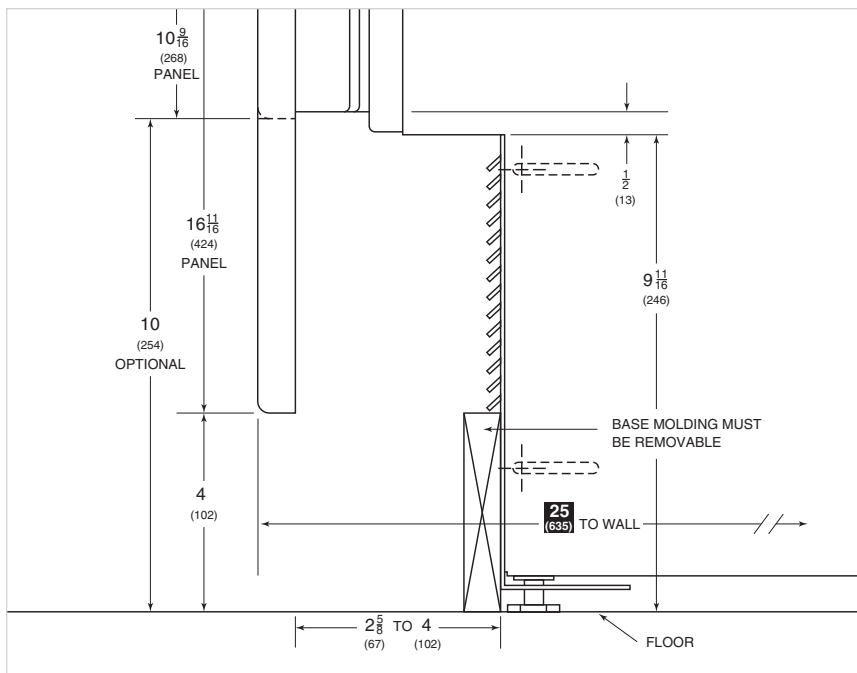



FRAMED CABINETRY

**IMPORTANT NOTE:** The depth of each Integrated model is 24" (610) from the front of the unit to its back. Your design may necessitate moving the unit back or cabinets forward to achieve a flush fit.

DOOR CLOSED  
Full-scale (top view)

105° MAXIMUM  
DOOR OPENING  
1/4 scale (top view)

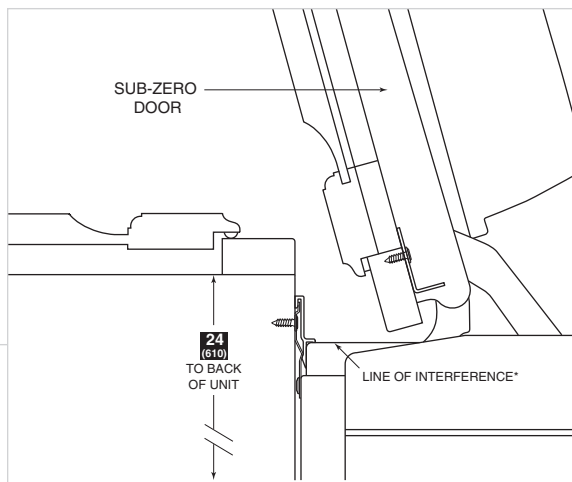
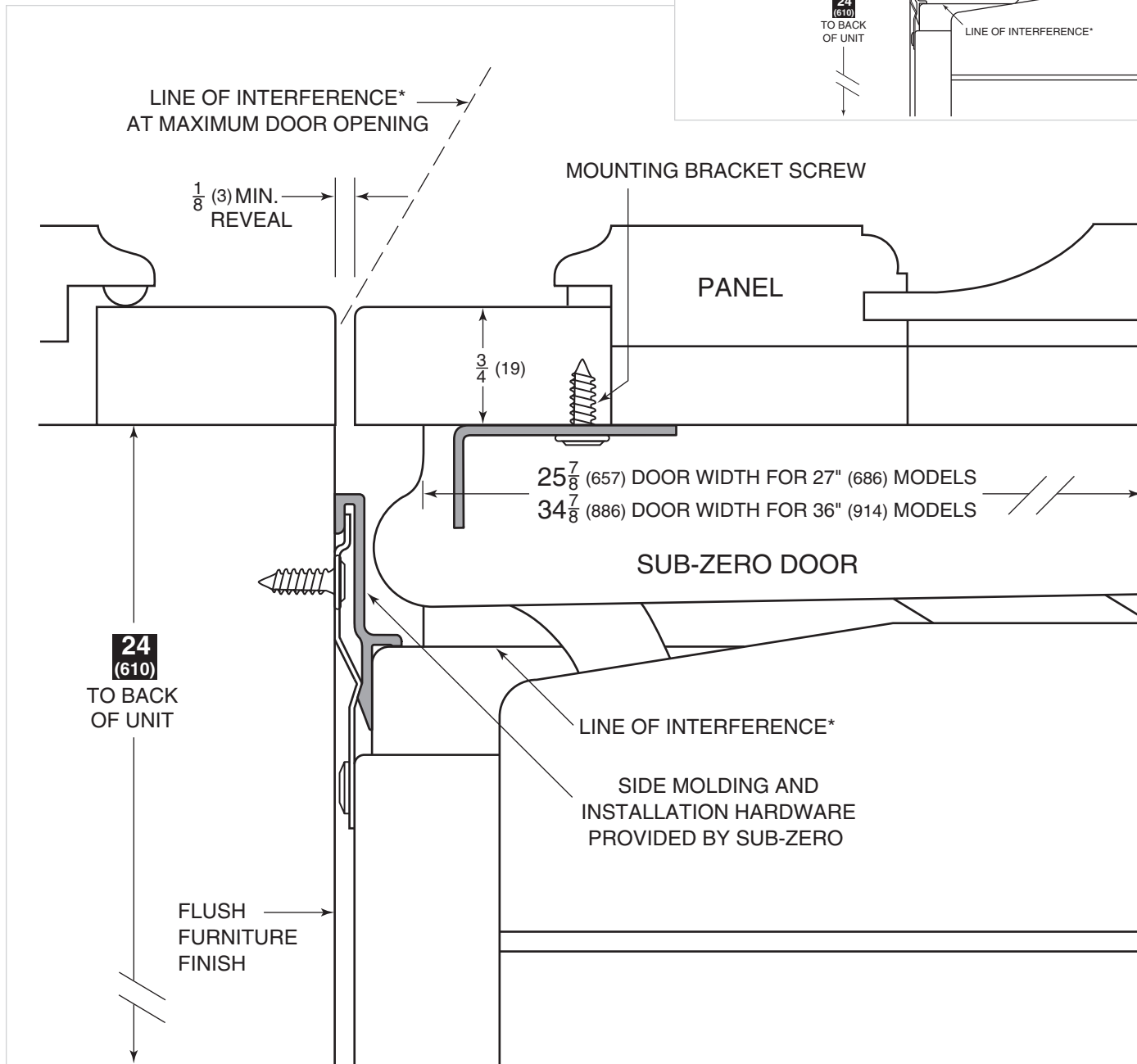

*\*If the panel is thicker than  $\frac{3}{4}$ " (19), it is recommended that you utilize the built-in 90° door stop to prevent damage to the panel and face frame.*





FRAMELESS CABINETRY

**IMPORTANT NOTE:** The depth of each Integrated model is 24" (610) from the front of the unit to its back. Your design may necessitate moving the unit back or cabinets forward to achieve a flush fit.

DOOR CLOSED  
Full-scale (top view)

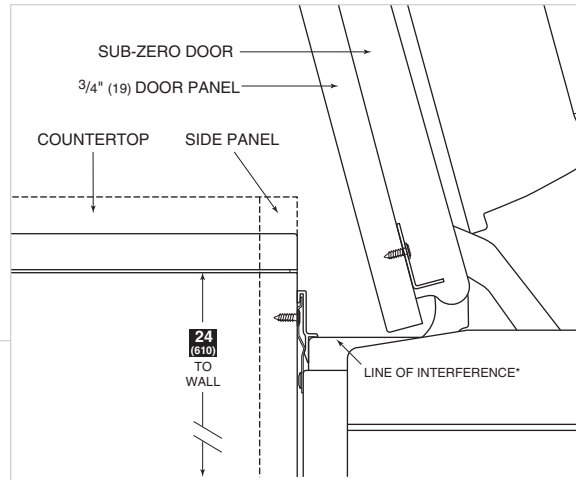

105° MAXIMUM DOOR OPENING  
1/4 scale (top view)  
Adjacent side panel and countertop application.

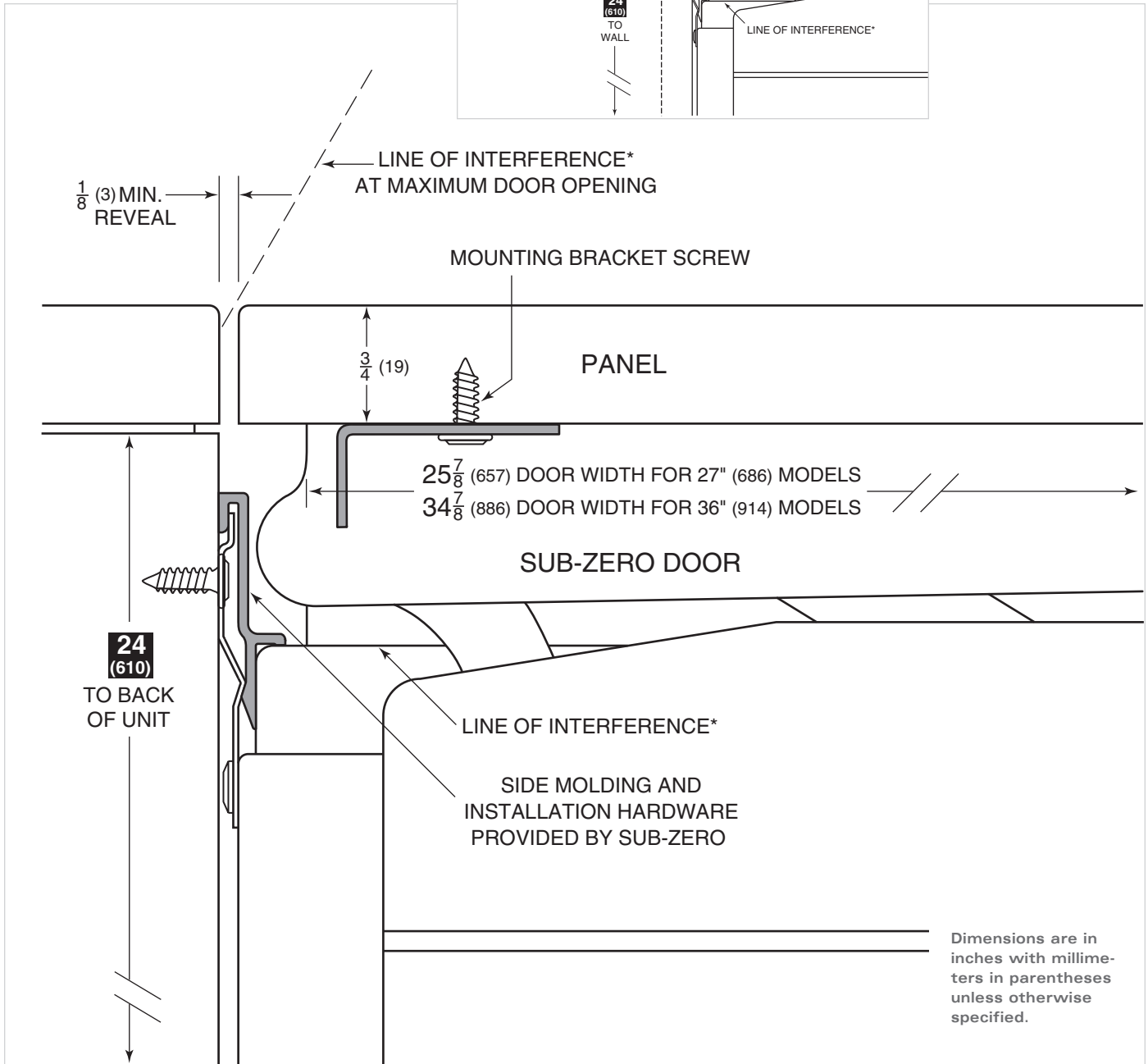

Dimensions are in inches with millimeters in parentheses unless otherwise specified.

\*If the panel is thicker than 3/4" (19), it is recommended that you utilize the built-in 90° door stop to prevent damage to the panel and face frame.



## WINE STORAGE

### UNDERCOUNTER

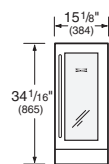

**MODEL 315W**  
Built-In

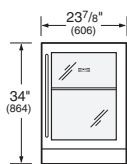

**MODEL 424**  
Built-In

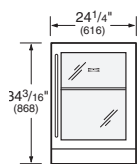

**MODEL 424FS**  
Free-Standing

### ALL WINE STORAGE

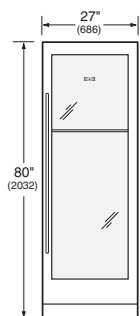

**MODEL 427**  
Integrated

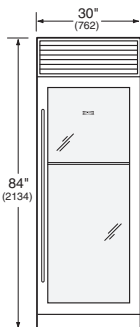

**MODEL 430**  
Built-In

*Model 430 has been redesigned as Model WS-30. For more information, visit our website, [subzero.com](http://subzero.com).*

### WINE STORAGE | REFRIGERATOR

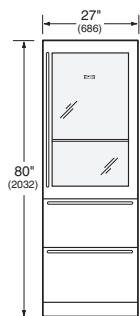

**MODEL 427R**  
Integrated

**With the installation of a harness kit, Wine Storage models, except Model 315W, are Star-K compliant to meet strict religious regulations in conjunction with specific instructions found on [www.star-k.org](http://www.star-k.org). For details about the harness kit, contact your Sub-Zero dealer.**

The illustrations represent the full line of Wine Storage models. The Model 424FS free-standing unit comes with a classic stainless steel exterior.

Comprehensive installation instructions are shipped with each model. Refer to those instructions in preparing and installing all Sub-Zero products. The instructions can also be found on our website, [subzero.com](http://subzero.com).

Dimensions in parentheses are in millimeters unless otherwise specified.

### WINE STORAGE

Sub-Zero's innovative addition to its complete line of residential refrigeration is wine storage equipment—the ultimate in beauty, engineering, and attention to detail. From the exterior and the smooth lines of the free-standing Model 424FS classic stainless steel to the ability to use wood on the Built-In and Integrated models, each unit is beautiful.

With the exception of the free-standing Model 424FS, each model is available in three stainless steel finishes and will have the capability of having wood panels applied to the doors. With the Model 427R, you can also apply the wood to the drawers.

The new Model 315W, a single-zone Wine Storage unit, comes only with a glass door and can be ordered as an overlay or classic stainless steel unit.

The free-standing Model 424FS does not require any panels or surrounding cabinetry; it comes with classic stainless steel exterior.

All models will be shipped with glass doors as standard equipment. The glass doors allow one to see the wine that is being stored. Optional solid doors and high altitude glass doors will be treated as special orders and must be ordered 90 days before you expect delivery. Model 315W cannot be ordered with a solid door.

Stainless steel models will be shipped with tubular stainless steel handles, while the overlay models will come with no handle hardware. Optional stainless steel panels and handles for Models 427 and 427R are offered in the classic, platinum and carbon stainless steel finishes and are ordered and shipped as sales accessories. The stainless steel Models 424 and 430 must be ordered in one of three stainless steel finishes of classic, platinum and carbon.

Optional handles are available for all models except the framed and stainless steel Model 430. The framed Model 430 will come with an extruded handle identical in design to our Built-In models.

Standard grille assemblies for the Model 430 will be provided in 1" (25) increments from 10" (254) to 15" (381). The standard height will be 11" (279). The framed model will have a louvered grille, the stainless steel model will feature a heavy-duty grille, and the overlay model will have the panel grille, which accepts decorative panel inserts.

For information regarding specific Wine Storage models, refer to the illustrations in this section.



## FEATURES AND OPTIONS

When looking for wine storage, you no longer have to think only about an undercounter application. Sub-Zero offers you complete flexibility from the perspective of design applications and storage capabilities.

Model 315W, a single-zone Wine Storage unit, comes as an overlay or classic stainless steel unit and is offered only with a glass door.

Model 424 comes in the overlay and stainless steel door panel configurations. Model 424FS (free-standing) is identical to the Model 424 but with classic stainless steel exterior and is designed to be attractive in a stand-alone setting. Models 424 and 424FS are available in either a glass or solid door model.

Models 427 and 427R are offered as integrated or stainless steel and are available in either a glass or solid door model. Optional stainless steel panels and handles are offered in classic, platinum and carbon stainless steel finishes at the 80" (2032) height, and only classic stainless steel at the 84" (2134) height. Stainless steel panels are available as sales accessories.

Model 430 comes in the framed, overlay and stainless steel options and is available in either a glass or solid door model. Stainless steel Model 430 must be ordered in one of the stainless steel finishes of classic, platinum and carbon.

**Built-In Look.** Sub-Zero offers you a host of design alternatives to choose from when selecting the look you want. Wood or stainless steel, framed, overlay or integrated.

**Dual Zone System\*.** With the exception of the single-zone Model 315W, all Wine Storage models allow you to have precise temperature control within one degree of your pre-set temperature in each of the two wine compartments.

**Dual Refrigeration System\*.** In a similar fashion to our Built-In, each Wine Storage model has dual refrigeration so your client will have specific, individual temperature control of the two wine compartments.

**Electronic Controls\*.** Microprocessor offers touch pad controls that are easy to understand and that set the temperatures accurately.

**Display Shelf\*.** This beautiful shelf offers your clients the opportunity to display those prize bottles or magnums of wine in their collection. It is illuminated with discreet lighting mounted in the control panel. (Not available with Models 315W, 424 and 424FS.)

**Storage Shelves.** The sturdy, rustproof wire shelves can easily accommodate standard 750 ml bottles, half bottles, as well as magnums. All the shelves are finished off with a natural cherry wood facing. In addition, all shelves will enable you to be sure the wine is stored properly and that the corks are in contact with the bottles' contents.

**Roller Assembly.** All shelves have a roller assembly, which enables you to have a three-quarter extension for easy access to all bottles of stored wine.

**Service Alert\*.** An indicator light will let you know if service may be necessary.

**Home Alarm\*.** Wiring connections give you the option of hooking the Wine Storage unit up to your home security system.

**Discreet Lighting.** Our soft low-wattage lighting is independent of door opening.

**Correct Temperature\*.** The range of each temperature zone is 38°F (3°C) to 65°F (18°C), and your set temperature is digitally displayed in the control panel.

**Humidity.** Proper humidity is maintained throughout the entire unit.

**UV Protection.** The tinted glass minimizes the amount of ultraviolet light entering the unit.

**Lock\*.** A lock will be offered as an option for all Wine Storage models. The lock is offered as a sales accessory and should be ordered through your Sub-Zero dealer. Special planning is necessary when ordering locks for Models 427 and 427R, refer to page 61 for details.

**Solid Door\*.** If you would like to order a model without glass, you have that option. This will be treated as a special order and must be ordered 90 days before you expect delivery.

**High Altitude Glass.** For installations above 5,000' (1524 m) in elevation, we offer the high altitude glass as a special order. The high altitude glass door is standard on Model 315W.

**Tight Seal.** Magnetic gaskets around the doors give extra-tight seals.

**Kickplate.** The solid, adjustable kickplate gives a true built-in look and conforms to American Institute of Architects standards.

**Front Venting.** All Sub-Zero Wine Storage models are designed for mechanical system airflow at the front of the appliance. Decorative panels must not cover louvered surfaces or prevent removal of louvered components.

## SUB-ZERO WARRANTY

Sub-Zero products are covered by a two, five and twelve year residential warranty (exclusions apply). See warranty details at the end of this guide.

\*Not available with Model 315W.

**MODEL 315W**UNDERCOUNTER  
BUILT-IN**MODEL OPTIONS**Overlay Design **315W/O**Classic Stainless Steel **315W/S****SPECIFICATIONS**

Overall Width **15<sup>1</sup>/<sub>8</sub>" (384)**  
 Overall Height **34<sup>1</sup>/<sub>16</sub>" (865)**  
 Overall Depth **24" (610)**  
 Wine Storage Capacity **26 bottles\***  
 Min Height Required **34<sup>1</sup>/<sub>16</sub>" (865)**  
 Door Swing Clearance **16<sup>5</sup>/<sub>8</sub>" (422)**  
 Specify Door Swing **LH or RH**  
 Shipping Wt (O) **114 lbs (52 kg)**  
 Shipping Wt (S) **118 lbs (54 kg)**

**FEATURES**

1 Temperature Zone  
 4 (750 ml) Bottles per Standard Shelf  
 6 Standard Shelves (24 bottles\*)  
 1 Fixed Bottle Holder (2 bottles\*)  
 Full-View High Altitude Glass Door

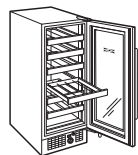
**MODEL 315W**

\*750 ml bottles.

\*\*High altitude glass doors are for installations at or above 5,000' (1524 m) in elevation and will be treated as a special order. Please allow 90 days for delivery. When ordering, add an (HA) before the (G) to obtain the correct model number.

\*\*\*Optional stainless steel panels and handles are ordered and shipped as sales accessories. For additional information on panel and handle sizes and applications, check our website, [subzero.com](http://subzero.com).

**MODEL 424**UNDERCOUNTER  
BUILT-IN**MODEL OPTIONS**Overlay Design **424/O**Classic Stainless Steel **424/S**Platinum Stainless Steel **424/P**Carbon Stainless Steel **424/B**

Full-View Glass Door (standard)

High Altitude Glass Door\*\*

Solid Door

**SPECIFICATIONS**

Overall Width **23<sup>7</sup>/<sub>8</sub>" (606)**  
 Overall Height **34" (864)**  
 Overall Depth **24" (610)**  
 Wine Storage Capacity **46 bottles\***  
 Min Height Required **34<sup>1</sup>/<sub>4</sub>" (870)**  
 Door Swing Clearance **25<sup>3</sup>/<sub>8</sub>" (645)**  
 Specify Door Swing **LH or RH**  
 Shipping Wt (glass) **190 lbs (86 kg)**  
 Shipping Wt (glass/S/P/B) **195 lbs (88 kg)**  
 Shipping Wt (solid) **185 lbs (84 kg)**

**FEATURES**

2 Temperature Zones  
 8 (750 ml) Bottles per Standard Shelf  
 2 Top Zone Shelves (16 bottles\*)  
 3 Bottom Zone Shelves (24 bottles\*)  
 1 Fixed Bottle Holder (6 bottles\*)  
 Full-View Glass Door

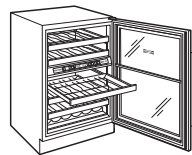
**MODEL 424****ACCESSORIES**

Contact your Sub-Zero Dealer

Classic stainless steel front panels—platinum and carbon available in certain sizes (Models 427 and 427R)\*

Tubular handles in classic, platinum and carbon stainless steel

Front, side and grille panels (framed Model 430)\*

**MODEL 424FS**UNDERCOUNTER  
FREE-STANDING**MODEL OPTIONS**

Full-View Glass Door (standard)

High Altitude Glass Door\*\*

Solid Door

**SPECIFICATIONS**

Overall Width **24<sup>1</sup>/<sub>4</sub>" (616)**  
 Overall Height **34<sup>3</sup>/<sub>16</sub>" (868)**  
 Overall Depth **24<sup>5</sup>/<sub>8</sub>" (625)**  
 Wine Storage Capacity **46 bottles\***  
 Door Swing Clearance **25<sup>3</sup>/<sub>8</sub>" (645)**  
 Specify Door Swing **LH or RH**  
 Shipping Wt **220 lbs (100 kg)**

**FEATURES**

2 Temperature Zones  
 8 (750 ml) Bottles per Standard Shelf  
 2 Top Zone Shelves (16 bottles\*)  
 3 Bottom Zone Shelves (24 bottles\*)  
 1 Fixed Bottle Holder (6 bottles\*)  
 Full-View Glass Door  
 Classic Stainless Steel Exterior and Door Frame

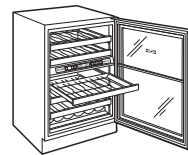
**MODEL 424FS**

Louvered, panel or stainless steel grilles in varied heights (Model 430)\*

UL-approved door lock kit

Dual installation heater kit (Models 427 and 427R)\*

\*Accessory is available only for models listed.



**MODEL 427**

ALL WINE STORAGE

**MODEL OPTIONS**

- Full-View Glass Door (standard)
- High Altitude Glass Door\*\*
- Solid Door

**SPECIFICATIONS**

Overall Width	<b>27" (686)</b>
Overall Height	<b>80" (2032)</b>
Overall Depth	<b>24" (610)</b>
Wine Storage Capacity	<b>132 bottles*</b>
Min Height Required	<b>79 1/2" (2019)</b>
Door Swing Clearance	<b>25 1/2" (648)</b>
Specify Door Swing	<b>LH or RH</b>
Shipping Wt (glass)	<b>395 lbs (179 kg)</b>
Shipping Wt (solid)	<b>386 lbs (175 kg)</b>

**FEATURES**

- 2 Temperature Zones
- 9 (750 ml) Bottles per Standard Shelf
- 5 Top Zone Shelves (45 bottles\*)
- 9 Bottom Zone Shelves (81 bottles\*)
- 1 Display Shelf (6 bottles\*)
- Full-View Glass Door

**PANEL OPTIONS**

- Integrated
- Classic, platinum or carbon stainless steel finish (includes handle)\*\*\*

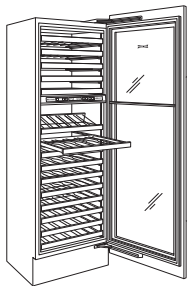

**MODEL 427**

**MODEL 430**

ALL WINE STORAGE

**MODEL OPTIONS**

- Framed Design **430/F**
- Overlay Design **430/O**
- Classic Stainless Steel **430/S**
- Platinum Stainless Steel **430/P**
- Carbon Stainless Steel **430/B**
- Full-View Glass Door (standard)
- High Altitude Glass Door\*\*
- Solid Door

**SPECIFICATIONS**

Overall Width	<b>30" (762)</b>
Overall Height	<b>84" (2134)</b>
Overall Depth	<b>24" (610)</b>
Wine Storage Capacity	<b>147 bottles*</b>
Min Height Required	<b>83" (2108)</b>
Door Swing Clearance	<b>30 1/8" (765)</b>
Specify Door Swing	<b>LH or RH</b>
Shipping Wt (glass)	<b>435 lbs (197 kg)</b>
Shipping Wt (glass/S/P/B)	<b>445 lbs (202 kg)</b>
Shipping Wt (solid)	<b>412 lbs (187 kg)</b>

**FEATURES**

- 2 Temperature Zones
- 10 (750 ml) Bottles per Standard Shelf
- 5 Top Zone Shelves (50 bottles\*)
- 9 Bottom Zone Shelves (90 bottles\*)
- 1 Display Shelf (7 bottles\*)
- Full-View Glass Door

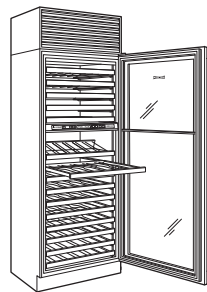

**MODEL 430**

*Model 430 has been redesigned as Model WS-30. For more information, visit our website, [subzero.com](http://subzero.com).*

**MODEL 427R**

WINE STORAGE | REFRIGERATOR

**MODEL OPTIONS**

- Full-View Glass Door (standard)
- High Altitude Glass Door\*\*
- Solid Door

**SPECIFICATIONS**

Overall Width	<b>27" (686)</b>
Overall Height	<b>80" (2032)</b>
Overall Depth	<b>24" (610)</b>
Wine Storage Capacity	<b>78 bottles*</b>
Refrigerator Capacity	<b>5.3 cu ft (150 L)</b>
Min Height Required	<b>79 1/2" (2019)</b>
Door Swing Clearance	<b>25 1/2" (648)</b>
Specify Door Swing	<b>LH or RH</b>
Drawer Clearance	<b>19 1/2" (495)</b>
Shipping Wt (glass)	<b>410 lbs (186 kg)</b>
Shipping Wt (solid)	<b>406 lbs (184 kg)</b>

**FEATURES**

- 3 Temperature Zones
- 2 Refrigerated Drawers
- 9 (750 ml) Bottles per Standard Shelf
- 6 Top Zone Shelves (54 bottles\*)
- 2 Bottom Zone Shelves (18 bottles\*)
- 1 Display Shelf (6 bottles\*)
- Full-View Glass Door

**PANEL OPTIONS**

- Integrated
- Classic, platinum or carbon stainless steel finish (includes handles)\*\*\*

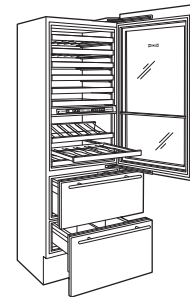

**MODEL 427R**

*NOTE: For Wine Storage standard glass door models, add (G) to the model number and for solid door models, add (S) to the model number (example 424G or 424S). The exception is Model 315W which is available as a glass door model only.*

**PLANNING INFORMATION**

Review the Overall Dimensions and Installation Specifications illustrations for your Wine Storage model on the following pages. These specifications cover all the details you need to know about space allocation and placement of electrical, whether the models are framed, overlay, stainless steel or integrated.

All Wine Storage models must be installed so that the door can open a minimum of 90° or you will have problems pulling the wine shelves out. Refer to the door clearance and door swing information.

For corner installations, you need allow for a minimum 3" (76) filler so the door can open to 90°. If you are using larger handle hardware, you will also need to take that into account.

For a maximum 90° door opening, use the door stop built into the hinge system of Model 427. An optional 90° door stop kit for Model 430 is available from your Sub-Zero dealer.

If you will be connecting the unit to a home security system, you must allow a minimum of 36" (914) of the system's wiring to be routed in the electrical area designated for your model.

**IMPORTANT NOTE:** The anti-tip bracket must be installed to prevent the unit from tipping forward.

**DUAL INSTALLATIONS**

If you are installing a Wine Storage unit next to an existing Sub-Zero unit, you may have to allow for a filler strip.

If you are installing a Model 427 or 427R Wine Storage unit next to an existing Integrated Sub-Zero unit, with 2" (51) or less between the units, an optional heater kit (BBDUAL or TTDUAL) will need to be installed to prevent moisture from forming between the units. This optional kit is available through your Sub-Zero dealer.

**ELECTRICAL REQUIREMENTS**

A 115 V AC, 60 Hz, 15 amp circuit breaker and electrical supply are required. A separate circuit servicing only this appliance is required.

All Sub-Zero Wine Storage models are equipped with a power supply cord with a 3-prong grounding plug, which must be plugged into a mating 3-prong grounding-type wall receptacle. Follow the National Electrical Code and local codes and ordinances when installing the receptacle. Refer to the Installation Specifications illustrations on the following pages for electrical placement for your model.

**IMPORTANT NOTE:** A ground fault circuit interrupter (GFCI) is not recommended and may cause interruption of operation.

## ACCESSORIES

Optional accessories are available through your Sub-Zero dealer. To obtain local dealer information, visit the Showroom Locator section of our website, [subzero.com](http://subzero.com).

Dimensions in parentheses are in millimeters unless otherwise specified.



OVERALL DIMENSIONS  
Undercounter Wine Storage

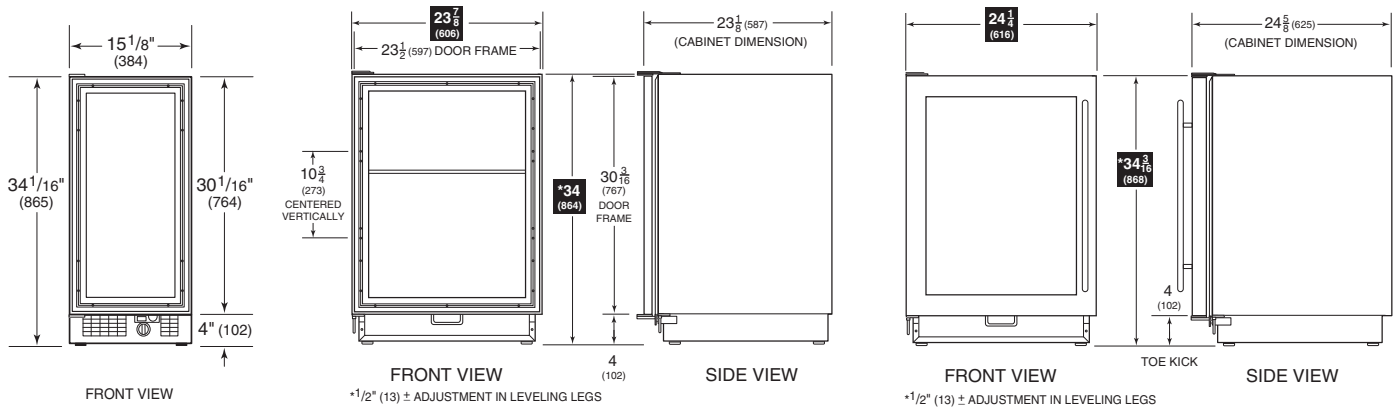

MODEL 315W  
Built-In

Width 15 1/8" (384)  
Height 34 1/16" (865)  
Depth 24" (610)

MODEL 424  
Built-In

Width 23 7/8" (606)  
Height 34" (864)  
Depth 24" (610)

MODEL 424FS  
Free-Standing

Width 24 1/4" (616)  
Height 34 3/16" (868)  
Depth 24 5/8" (625)

UNDERCOUNTER

Model 315W  
Built-In  
Model 424  
Built-In  
Model 424FS  
Free-Standing

Note the location of pre-drilled holes for optional handle hardware.

INSTALLATION SPECIFICATIONS  
Undercounter Models

Model 315W

- A) Rough Opening Width 15 1/4" (387)
- B) Rough Opening Height 34 1/2" (876)
- C) Min Door Clearance 16 5/8" (422)
- D) Min Clearance at 90° 17 1/4" (438)

Model 424

- A) Rough Opening Width 24" (610)
- B) Rough Opening Height 34 1/2" (876)
- C) Min Door Clearance 25 3/8" (644)
- D) Min Clearance at 90° 26" (660)

Model 424FS\*

- C) Min Door Clearance 25 3/8" (644)
- D) Min Clearance at 90° 26" (660)

\*Free-standing Model 424FS requires no surrounding cabinetry.

Dimensions are for finished rough openings.

Door swing clearances are based on stainless steel door and handle dimensions.

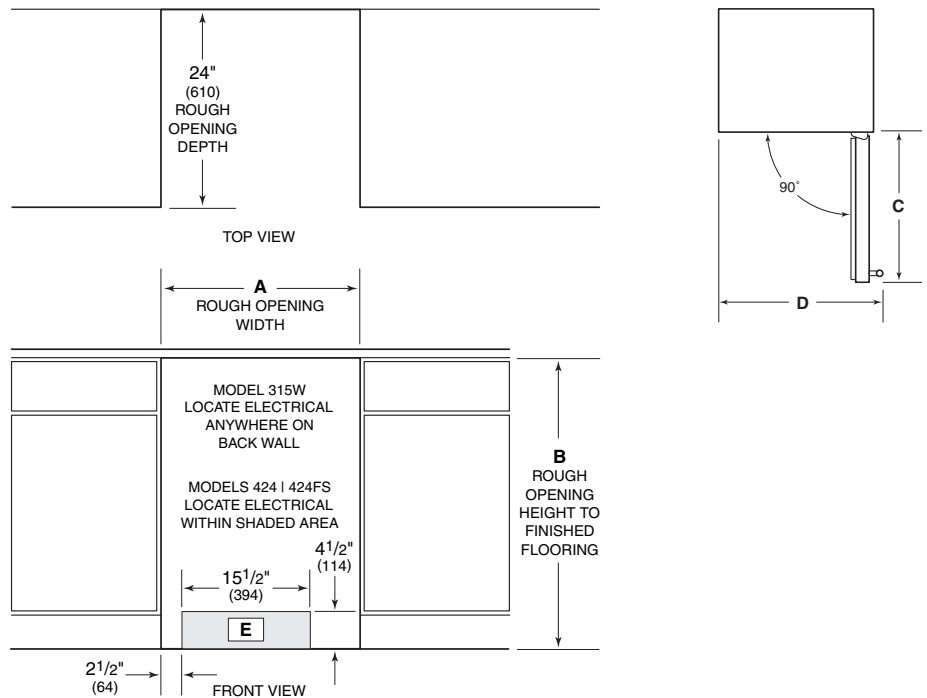

Refer to installation instructions shipped with each Wolff product for detailed specifications.



# WINE STORAGE

## OVERALL DIMENSIONS

All Wine Storage - Model 427

Wine Storage Refrigerator - Model 427R

### INTEGRATED

**Model 427**  
All Wine Storage

**Model 427R**  
Wine Storage Refrigerator

### OVERALL DIMENSIONS

Model 427 | 427R

Width **27" (686)**  
Height **80" (2032)**  
Depth **24" (610)**

Note the location of pre-drilled holes for optional handle hardware.

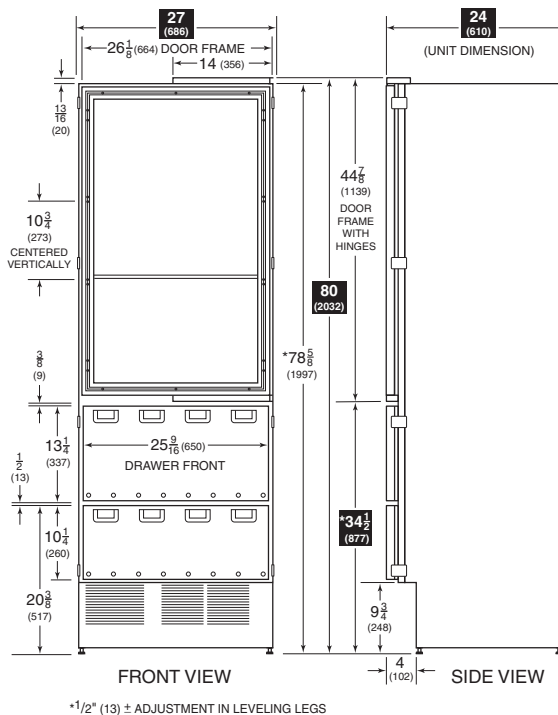
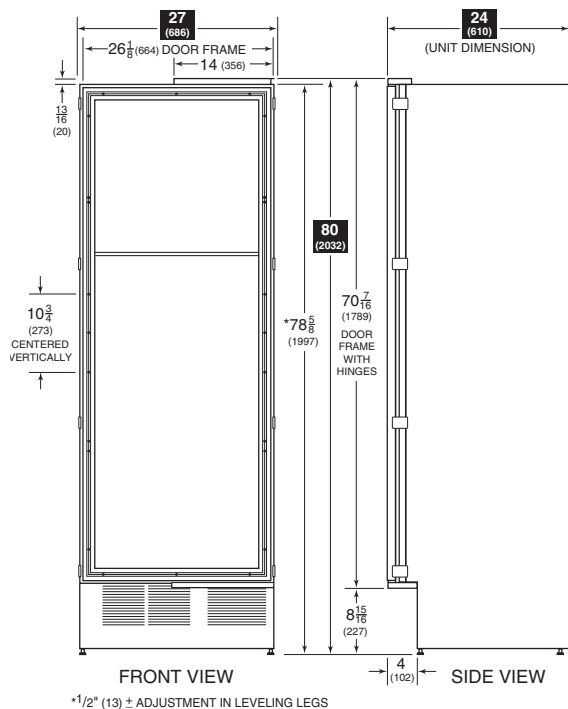

## INSTALLATION SPECIFICATIONS

Models 427 | 427R

Dimensions are for finished rough openings.

Door swing clearances are based on stainless steel door and handle dimensions.

**IMPORTANT NOTE:** The depth of Models 427 and 427R is 24" (610) from the front of the unit to its back. Your design may necessitate moving the unit back or cabinets forward to achieve a flush fit. This will require a minimum rough opening depth of 25" (635).

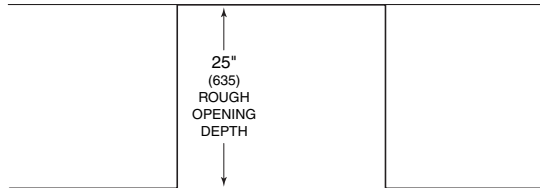

TOP VIEW

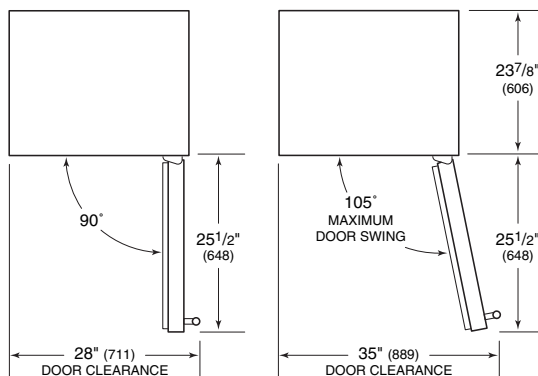

Dimensions in parentheses are in millimeters unless otherwise specified.

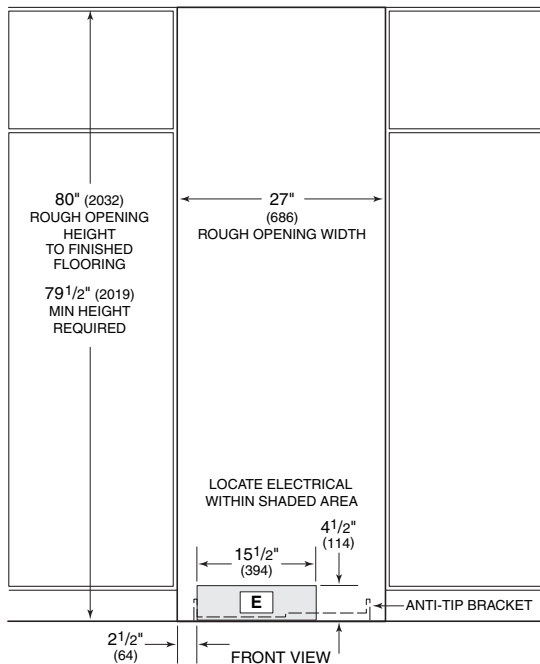





OVERALL DIMENSIONS

All Wine Storage - Model 430

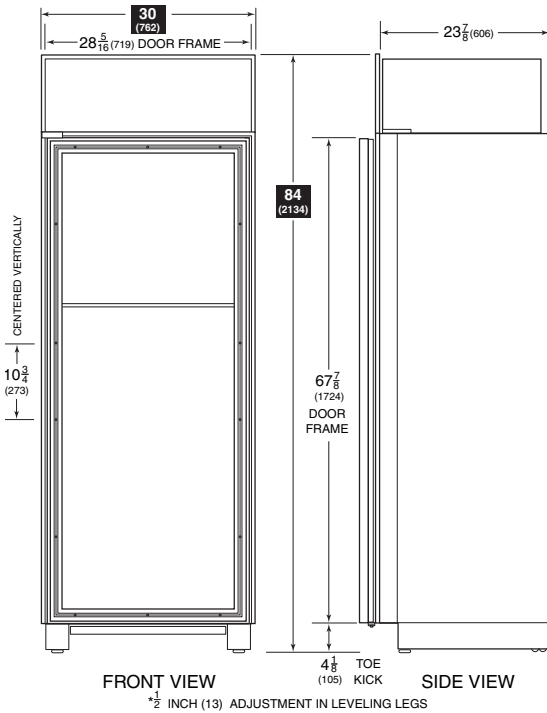

ALL WINE STORAGE

Model 430  
Built-In

OVERALL DIMENSIONS  
Model 430

Width 30" (762)  
Height 84" (2134)  
Depth 24" (610)

Note the location of pre-drilled holes for optional handle hardware.

INSTALLATION SPECIFICATIONS

All Wine Storage - Model 430

Dimensions are for finished rough openings.

Door swing clearances are based on stainless steel door and handle dimensions.

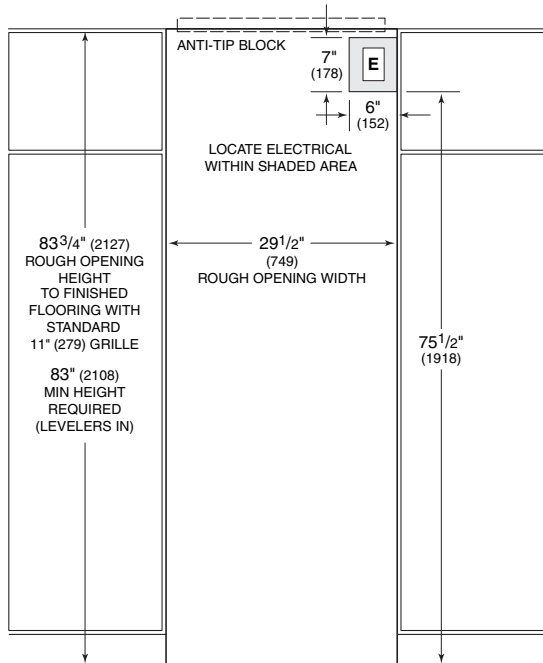
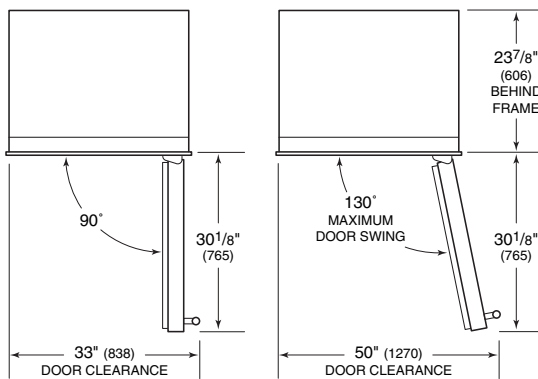
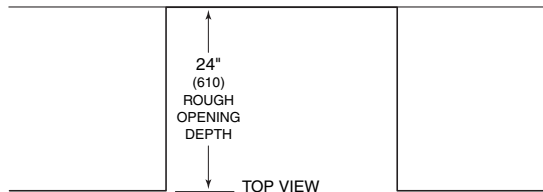

Refer to installation instructions shipped with each Wolf product for detailed specifications.



**DOOR PANELS**

Unless you are installing a stainless steel model, you will need to provide a complete door panel in the instance of a solid door model, or a frame for the glass door application where wine will be seen from the outside. If you order a stainless steel unit, Models 315W, 424, 424FS and 430 will be shipped with their panels and hardware installed and you will merely install the Sub-Zero. However, for Models 427 and 427R, you will have to have the stainless steel panels and handles installed.

Wine Storage solid door models are available as a special order. You must allow 90 days from the time of order until you can expect delivery.

**MODEL 424FS – FREE-STANDING**

The free-standing Model 424FS does not require any panels or surrounding cabinetry. It has a beautiful classic stainless steel exterior, door frame and handle. Refer to the Overall Dimensions illustration for the Model 424FS.

ACCESSORIES

Optional accessories are available through your Sub-Zero dealer. To obtain local dealer information, visit the Showroom Locator section of our website, [subzero.com](http://subzero.com).

CABINETY DIMENSIONS

*Model 315W*

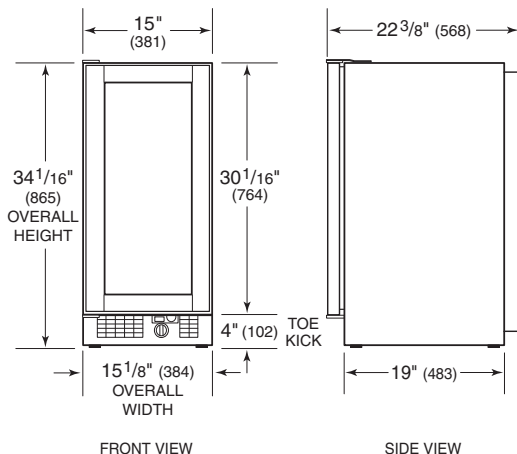

OVERLAY PANEL SPECIFICATIONS

*Model 315W*

Door Panel Width	<b>15" (381)</b>
Door Panel Height	<b>30 1/16" (764)</b>
Min Width of Rails and Stiles	<b>2 1/4" (57)</b>
Door Frame Panel Weight Limit	<b>10 lbs (5 kg)</b>
Min Panel Thickness	<b>5/8" (16)</b>

Dimensions in parentheses are in millimeters unless otherwise specified.



**OVERLAY PANELS –  
MODELS 315W | 424**

The overlay panel applied to Models 315W and 424 should not be confused with the Built-In overlay panel application. The overlay panel will consist of only a frame and would be either the 5/8" (16) or 3/4" (19) thick panel you may be using. It is affixed directly to the door itself with screws through a series of pre-drilled holes in the perimeter of the door itself. You do not need any backer or spacer panel.

Refer to the Overall Dimensions and Cabinetry Dimensions illustrations for Models 315W and 424 to give you a better idea of the exact space our unit needs and how the panel fits in relationship with the unit.

The glass door opening of the standard Model 315W and 424 are designed to be exposed to room air circulation. Decorative overlays on the glass should be kept to a minimum. Also, rails and stiles can be increased in size but should not exceed cabinet manufacturers' standard width. They cannot exceed overall door panel dimensions specified, as they would interfere with the operation of the door. The back sides of rails and stiles that will be visible through the glass door will need to be finished. Also, the inside edges of the frames must be finished to match the front surface.

The Overall Dimensions illustrations show the location of predrilled holes for optional handle hardware. Refer to page 64 for specifics about installing handles on this overlay application.

**IMPORTANT NOTE:** Wine Storage models with a solid door are available as a special order and require 90 days for delivery. When ordering panels for a solid door unit, follow the overall panel dimensions listed; rail and stile dimensions do not apply. Model 315W is not available with a solid door.

**IMPORTANT NOTE:** When planning to install the Model 315W or 424 next to adjoining cabinetry, you must make provisions to allow the door to open to a maximum of 145° and not interfere with the door panel. Refer to the full-scale illustration at the end of this section.

INSTALLATION

To install overlay panels, see the detailed procedures outlined in the Sub-Zero Wine Storage Installation Instructions.

**CAUTION**

A solid panel must not be installed on a glass door unit, as this may cause moisture to form behind the panel.

CABINERY DIMENSIONS

Model 424

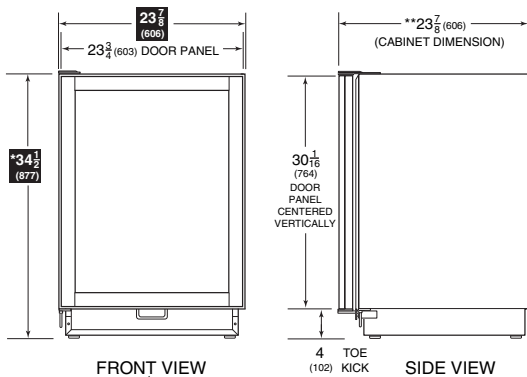

\*\* MODEL 424/S (STAINLESS STEEL WRAPPED DOOR) FINISHES OFF AT 23 5/8 INCHES DEEP

OVERLAY PANEL SPECIFICATIONS

Model 424

Door Panel Width	<b>23 3/4" (603)</b>
Door Panel Height	<b>30 1/16" (764)</b>
Min Width of Rails and Stiles	<b>2 1/4" (57)</b>
Door Frame Panel Weight Limit	<b>10 lbs (5 kg)</b>
Solid Door Panel Weight Limit	<b>20 lbs (9 kg)</b>
Min Panel Thickness	<b>5/8" (16)</b>



### INTEGRATED PANELS – MODELS 427 | 427R

The integrated full panels or frame panels for glass doors for these models will follow some of the identical planning processes used with the Integrated line. The installation of the door panels is completely different, however. Rather than using the mounting hardware we used with the Integrated line, door panels for both Models 427 and 427R will be applied with screws applied through our door.

The drawer panels for the Model 427R will be applied using the Integrated technique of mounting brackets.

Refer to the Overall Dimensions and Cabinetry Dimensions illustrations for Models 427 and 427R to give you a better idea of the exact space our unit needs and how the panel fits in relationship with the unit.

**IMPORTANT NOTE:** The depth of Models 427 and 427R is 24" (610) from the front of the unit to its back. You **must** allow for the thickness of the panel you are applying when planning for the finished rough opening depth if you want the front panel to be flush with surrounding cabinetry. You may have to move the unit back into the drywall or bring the cabinets forward. Refer to the Integrated Refrigeration section.

**IMPORTANT NOTE:** The glass door opening of the standard Models 427 and 427R is designed to be exposed to room air circulation. Decorative overlays on the glass should be kept to a minimum. While the cabinet front stiles are a minimum of 2 1/4" (57) for both Models 427 and 427R, the top and bottom rails are different.

Rails and stiles can be increased in size but should not exceed cabinet manufacturers' standard width. They cannot exceed overall door panel dimensions specified, as they would interfere with the operation of the door. The back sides of rails and stiles that will be visible through the glass door will need to be finished. Also, the inside edges of the frames must be finished to match the front surface.

**IMPORTANT NOTE:** The inside edges of the rough opening will need to be finished as they will be exposed when the doors are open.

#### ACCESSORIES

Optional accessories are available through your Sub-Zero dealer. To obtain local dealer information, visit the Showroom Locator section of our website, [subzero.com](http://subzero.com).

#### CABINETRY DIMENSIONS Model 427

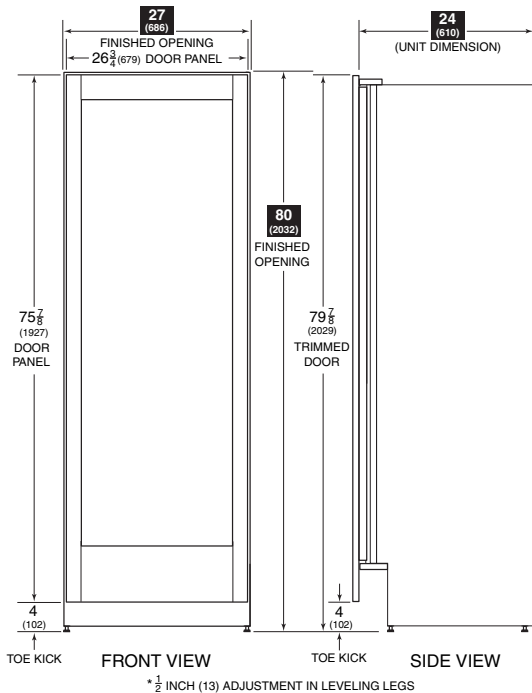

#### INTEGRATED PANEL SPECIFICATIONS Model 427

Door Panel Width	<b>26 3/4" (679)</b>
Door Panel Height	<b>75 7/8" (1927)</b>
Min Width of Top Rail	<b>3 3/4" (95)</b>
Min Width of Bottom Rail	<b>8" (203)</b>
Min Width of Stiles	<b>2 1/4" (57)</b>
Door Frame Panel Weight Limit	<b>20 lbs (9 kg)</b>
Solid Door Panel Weight Limit	<b>40 lbs (18 kg)</b>
Min Panel Thickness	<b>5/8" (16)</b>

Dimensions in parentheses are in millimeters unless otherwise specified.



**INTEGRATED PANELS –  
MODELS 427 | 427R**

**IMPORTANT NOTE:** The dimensions of these panels and stiles are assuming the models finish off at 80" (2032) in height overall and have a 4" (102) toe kick for the Model 427. If you finish off at 84" (2134), for instance, you must add 4" (102) additional to the overall height of the panel and remember to add 4" (102) to the top rail. Likewise, if you allow for a 6" (152) toe kick for the Model 427, you must subtract 2" (51) from the bottom rail.

Door panels for Models 427 and 427R can grow beyond the 80" (2032) height to accommodate any size door as long as you stay below door panel weight limit of 20 lbs (9 kg) for glass door units and 40 lbs (18 kg) for solid door units. Refer to the specifications under Door Panel Height on page 47 of the Integrated section.

**IMPORTANT NOTE:** The toe kick area on the Model 427 cannot be larger than 6" (152), and no larger than 9" (229) for the 427R. The toe kick area for either model cannot be less than 4" (102).

In the Overall Dimensions illustrations, note the location of pre-drilled holes for optional handle hardware. Refer to page 64 for specifics about installing handle hardware on this overlay application.

**IMPORTANT NOTE:** If you are installing Sub-Zero’s optional lock kit on a Model 427 or 427R, you may have to order door panels that exceed the 80" (2032) finished height. Consult the lock kit installation instructions and see if your panels will allow for an adequate installation. To obtain these instructions, check our website, subzero.com.

**IMPORTANT NOTE:** In the panel specifications for Model 427R, the bottom drawer panel height is based on a 4" (102) toe kick. If you want to show a 6" (152) toe kick, you must subtract 2" (51) from the bottom drawer panel height.

**IMPORTANT NOTE:** Wine Storage models with a solid door are available as a special order and require 90 days for delivery. When ordering panels for a solid door unit, follow the overall panel dimensions indicated in the chart; rail and stile dimensions do not apply.

INSTALLATION

To install integrated panels, see the detailed procedures outlined in the Sub-Zero Wine Storage Installation Instructions.

**⚠ CAUTION**

**A solid panel must not be installed on a glass door unit, as this may cause moisture to form behind the panel.**

CABINETRY DIMENSIONS  
Model 427R

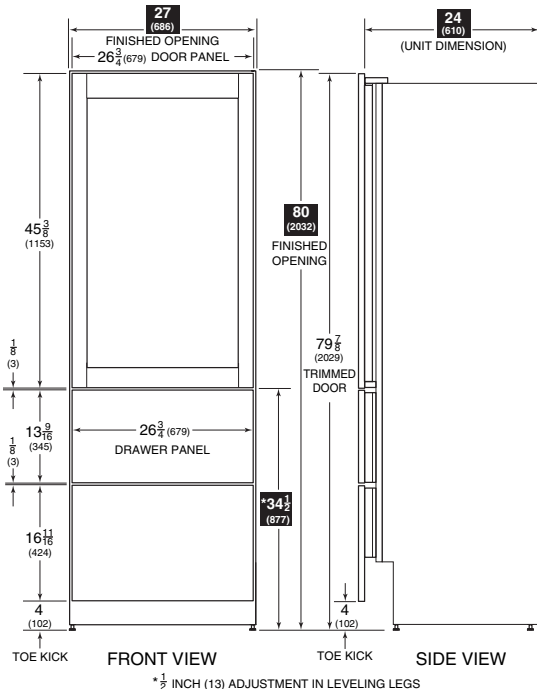

INTEGRATED PANEL SPECIFICATIONS  
Model 427R

Door Panel Width	26 3/4" (679)
Door Panel Height	45 3/8" (1153)
Min Width of Top Rail	3 3/4" (95)
Min Width of Bottom Rail	3" (76)
Min Width of Stiles	2 1/4" (57)
Door Frame Panel Weight Limit	20 lbs (9 kg)
Solid Door Panel Weight Limit	40 lbs (18 kg)
Top Drawer Panel Width	26 3/4" (679)
Top Drawer Panel Height	13 9/16" (345)
Bottom Drawer Panel Width	26 3/4" (679)
Bottom Drawer Panel Height	16 11/16" (424)
Drawer Panel Weight Limit	12 lbs (5 kg) each
Min Panel Thickness	5/8" (16)



**MODEL 430 – FRAMED PANELS**

You cannot use a 1/4" (6) panel to cover the glass door of a framed Model 430. It is fine when applying a panel to the solid door, but in either instance, you should consider using raised panels with a minimum 5/8" (16) thickness.

When using a raised framed panel, you must allow for the edge to be routed 1/4" (6) around the panel to ensure a proper fit. Refer to illustration 1.

With the framed Model 430, you will receive an extruded handle identical in appearance to the Built-In models. However, it will be an extended handle and will enable you to use raised panels without providing finger clearance to open the door.

**IMPORTANT NOTE:** Wine Storage models with a solid door are available as a special order and require 90 days for delivery. When ordering panels for a solid door unit, follow the overall panel dimensions indicated; rail and stile dimensions do not apply.

**▲ CAUTION**

**A solid panel must not be installed on a glass door unit, as this may cause moisture to form behind the panel.**

**MODEL 430 – OVERLAY PANELS**

Your overlay model will be shipped without handle hardware and with an 11" (279) overlay panel grille as standard equipment. You will need to order a panel for the grille and hardware to complement your surrounding cabinetry.

While the overlay panel design offers you a more seamless appearance, you need to be aware of adjacent cabinets and/or countertops when the door is opened. Refer to the full-scale illustrations at the end of the Built-In section.

To achieve the overlay look, you need three different panels—the decorative overlay panel, a 0.10" (3) spacer panel and a 1/4" (6) backer panel. Depending on your cabinet manufacturer, this could be one panel routed for different dimensions or more likely, three different panels. Refer to the Overlay Panel Specifications for complete details on the overlay sizing. In addition, illustrations 2 and 3 will give you a better idea of the panel construction and how it interacts with our frame.

The glass door opening of the standard Model 430 is designed to be exposed to room air circulation. Decorative overlays on the glass should be kept to a minimum. Also, rails and stiles can be increased in size but should not exceed cabinet manufacturers' standard width. They cannot exceed overall door panel dimensions specified, as they would interfere with the operation of the door.

The back sides of rails and stiles that will be visible through the glass door will need to be finished. Also, the inside edges of the frames must be finished to match the front surface.

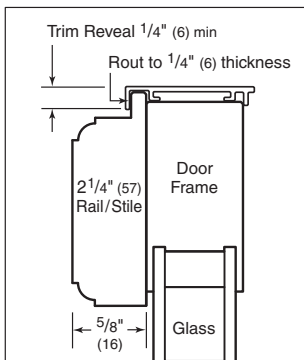

Illus. 1

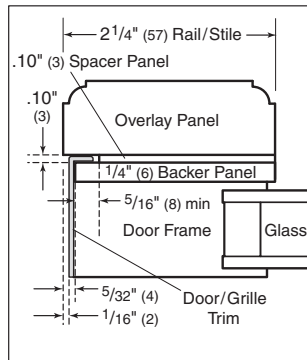

Illus. 2

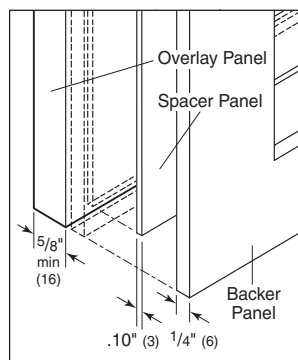

Illus. 3



**MODEL 430 – OVERLAY PANELS**

As with the Sub-Zero Built-In models, you have the flexibility of ordering grilles in a variety of heights for either the framed or overlay application. Optional panel grille dimensions for the framed Model 430 are the same as listed for Built-In Models 611 and 611G on page 21.

Overlay grille panel dimensions for the overlay Model 430, standard 11" (279) grille, are listed below. Refer to page 25 for optional grille height dimensions. The width of the overlay grille, spacer and backer panel will be the same regardless of the height.

In addition, side panel information for a Model 430 is available on page 26 of the Built-In section. Refer to illustration 12 on page 26 for placement of toe kick and grille area cut-outs.

**IMPORTANT NOTE:** Wine Storage models with a solid door are available as a special order and require 90 days for delivery. When ordering panels for a solid door unit, follow the overall panel dimensions indicated; rail and stile dimensions do not apply.

**⚠ CAUTION**  
**A solid panel must not be installed on a glass door unit, as this may cause moisture to form behind the panel.**

INSTALLATION

To install framed or overlay panels, see the detailed procedures outlined in the Sub-Zero Wine Storage Installation Instructions.

CABINETRY DIMENSIONS  
 Model 430



FRAMED PANEL SPECIFICATIONS  
 Model 430 – Framed (F)

Framed Door Panel Width	<b>28<sup>7</sup>/<sub>8</sub>" (714)</b>
Framed Door Panel Height	<b>67<sup>11</sup>/<sub>16</sub>" (1719)</b>
Min Width of Rails and Stiles	<b>2<sup>1</sup>/<sub>4</sub>" (57)</b>
Door Frame Panel Weight Limit	<b>25 lbs (11 kg)</b>
Solid Door Panel Weight Limit	<b>50 lbs (23 kg)</b>
Min Panel Thickness	<b>5<sup>5</sup>/<sub>8</sub>" (16)</b>

OVERLAY PANEL SPECIFICATIONS  
 Model 430 – Overlay (O)

Overlay Door Panel Width	<b>28<sup>7</sup>/<sub>16</sub>" (722)</b>
Overlay Door Panel Height	<b>68" (1727)</b>
Spacer Panel Width	<b>27<sup>1</sup>/<sub>2</sub>" (699)</b>
Spacer Panel Height	<b>67<sup>1</sup>/<sub>16</sub>" (1073)</b>
Backer Panel Width	<b>28<sup>1</sup>/<sub>8</sub>" (714)</b>
Backer Panel Height	<b>67<sup>11</sup>/<sub>16</sub>" (1719)</b>
Min Width of Rails and Stiles	<b>2<sup>1</sup>/<sub>4</sub>" (57)</b>
Door Frame Panel Weight Limit	<b>25 lbs (11 kg)</b>
Solid Door Panel Weight Limit	<b>50 lbs (23 kg)</b>
Min Panel Thickness	<b>5<sup>5</sup>/<sub>8</sub>" (16)</b>

GRILLE PANEL SPECIFICATIONS  
 Model 430 – Overlay (O)

Overlay Grille Panel Width	<b>28<sup>7</sup>/<sub>16</sub>" (722)</b>
Overlay Grille Panel Height*	<b>10<sup>1</sup>/<sub>4</sub>" (260)</b>
Spacer Panel Width	<b>27<sup>1</sup>/<sub>2</sub>" (699)</b>
Spacer Panel Height*	<b>9<sup>5</sup>/<sub>16</sub>" (236)</b>
Backer Panel Width	<b>28<sup>1</sup>/<sub>8</sub>" (714)</b>
Backer Panel Height*	<b>9<sup>15</sup>/<sub>16</sub>" (252)</b>
Grille Panel Weight Limit	<b>15 lbs (7 kg)</b>
Min Panel Thickness	<b>5<sup>5</sup>/<sub>8</sub>" (16)</b>

Dimensions in parentheses are in millimeters unless otherwise specified.

\*Grille panel dimensions are for standard 11" (279) grille. Refer to page 25 for optional grille heights.



### HARDWARE CONSIDERATIONS

With Models 315W and 424 (overlay), Models 427 and 427R (integrated) and the Model 430 (overlay), you must supply your own handle hardware. It is recommended you use our optional handles and use the pre-drilled holes supplied to locate the handles within the frame of our unit. The metal frame on the door has numerous mounting holes on each side to accommodate Sub-Zero accessory handles. This will allow you to provide the best possible handle alignment and not take away from the strength of the stile in this area after the unit is used a number of times. We recommend using a pull handle and not a pull knob.

If you elect to place different hardware on these units, we encourage you to fasten the hardware by passing through our door and attaching the hardware through the Sub-Zero door's frame.

Optional stainless steel handles are available in a variety of diameters and lengths, as are handles to match the color and style of Wolf ovens. Contact your Sub-Zero dealer for specifics.

#### **▲ CAUTION**

**When planning for hardware, refer to the Door Frame Profile full-scale illustration on the following page to give you a better understanding of the unit's frame and positioning of the glass for the door. You must not drill through this glass.**

### WINE SHELF WOOD FACING

Sub-Zero has provided a natural cherry wood facing to its wine storage shelves in each model. You can also replace these strips with wood more complementary to your design and surrounding cabinetry.

The Wine Shelf Wood Facing illustration on the following page can be used as a full-scale template. You must follow the layout of this format to accommodate the shelves properly. To remove the cherry strips, take the shelves out and remove the screws. Reverse the procedure to affix the new wood.

If you choose to stain or seal the wood facing, be aware that some of these substances are hazardous and will damage stored wine.

### ACCESSORIES

Optional accessories are available through your Sub-Zero dealer. To obtain local dealer information, visit the Showroom Locator section of our website, [subzero.com](http://subzero.com).

Dimensions in parentheses in millimeters unless otherwise specified.





DOOR FRAME PROFILE

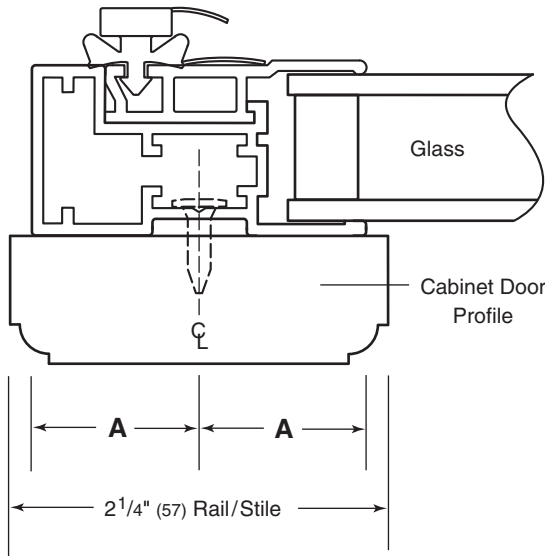

DOOR FRAME HANDLE OFFSET  
Wine Storage Models

Model	Dimension A
Model 315W	1" (25)
Model 424	1" (25)
Model 427	7/8" (22)
Model 427R	7/8" (22)
Model 430	15/16" (24)

FULL-SCALE TEMPLATES

The full-scale illustrations on the following pages enable you to understand some of the unique situations you may face as you plan for the installation of the Wine Storage units. Use these illustrations as templates.

**IMPORTANT NOTE:** Rails and stiles must be a minimum of 2 1/4" (57) wide (except for the rails of Models 427 and 427R, which must be wide enough to cover the door hinges). The back sides of rails and stiles that will be visible through the glass door will need to be finished.

This full-scale illustration is typical of the Model 424 door frame profile; details of the other Wine Storage door frames will vary slightly.

WINE SHELF WOOD FACING

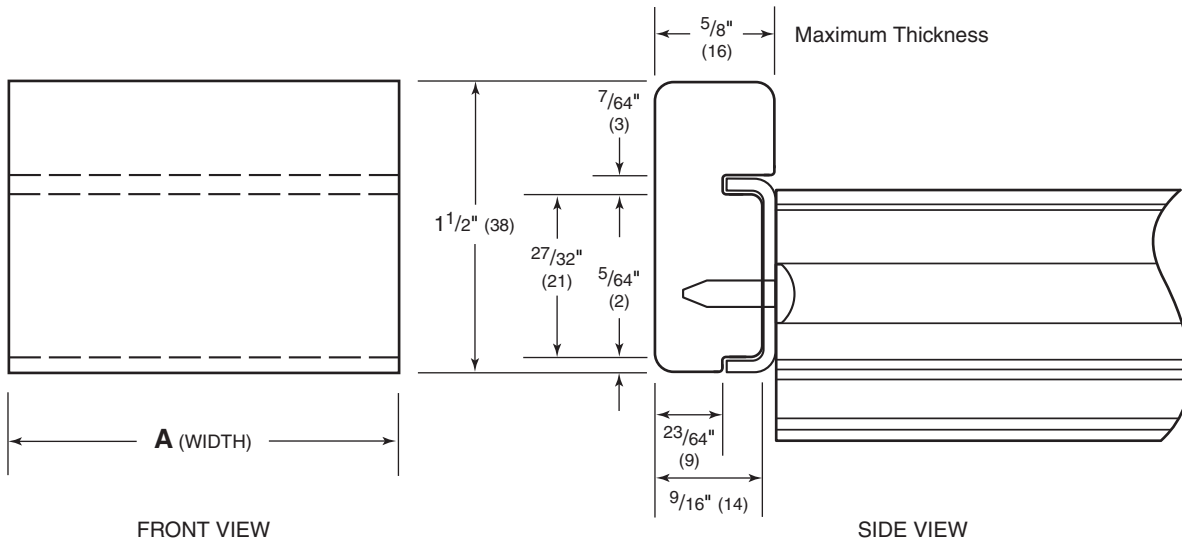

This full-scale illustration provides the dimensions you will need should you choose to replace the natural cherry wood facing of each wine shelf with wood more complementary to your design and surrounding cabinetry.

**IMPORTANT NOTE:** Dimensions will vary for Model 315W. Additional information can be found in the Specifications pdf file for Model 315W on our website, [subzero.com](http://subzero.com).

WINE SHELF WOOD FACING  
Wine Storage Models

Model	Dimension A
Model 315W*	10 15/16" (278)
Model 424	19 1/2" (495)
Model 424FS	19 1/2" (495)
Model 427	20 15/16" (532)
Model 427R	20 15/16" (532)
Model 430	24 9/16" (624)

\*Dimensions will vary for Model 315W.



MODEL 424 - DOOR CLOSED AND 145° MAX OPENING

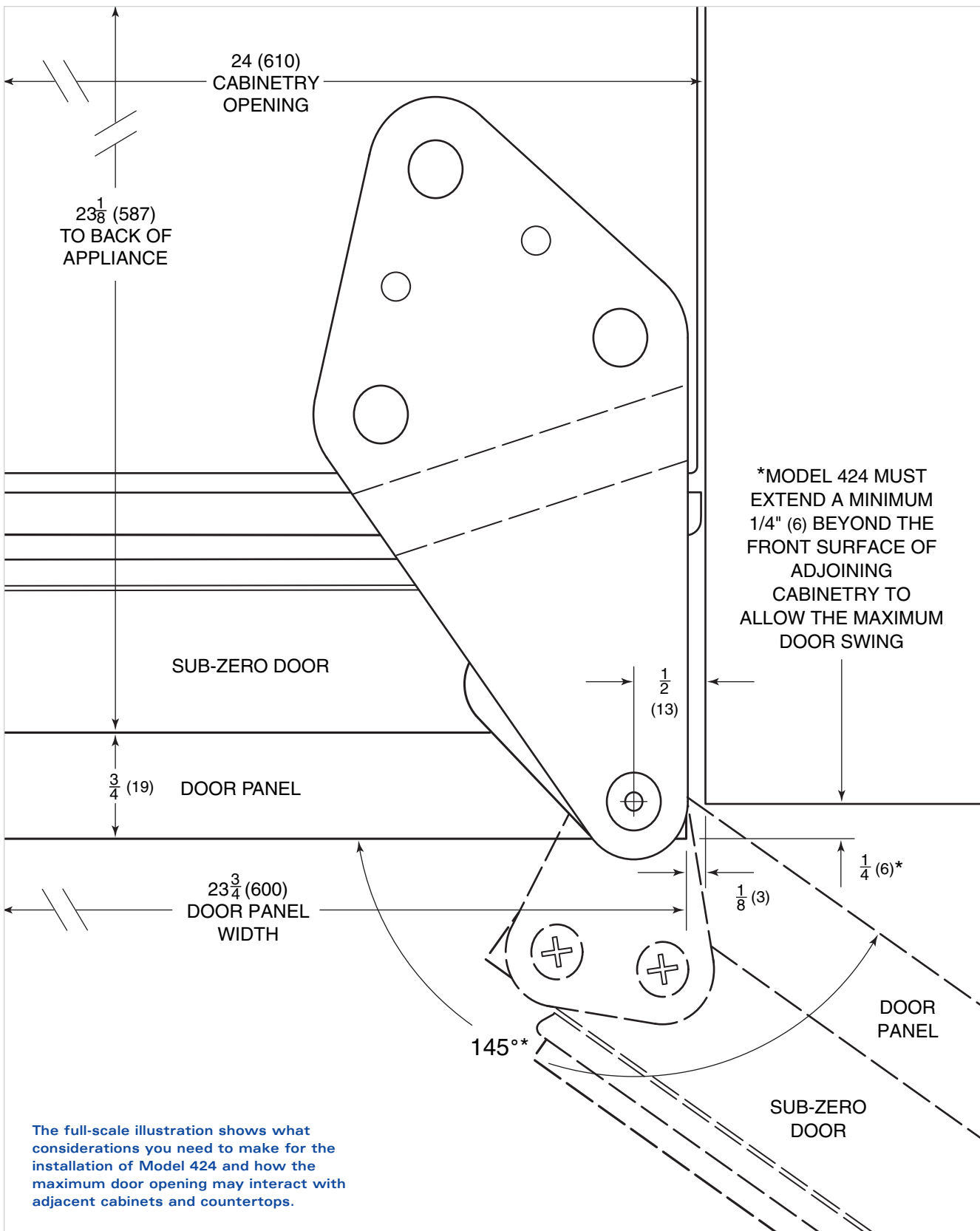



**NEW UNDERCOUNTER REFRIGERATION**

*Available in 2007*

Aside from the full-size models that Sub-Zero offers in its Built-In and Integrated lines of refrigeration and its Wine Storage equipment, we round out our product line-up with a new line of Undercounter refrigeration available in 2007.

Our new Undercounter line consists of an all refrigerator model, an all refrigerator beverage center, a refrigerator/freezer combination model and an all refrigerator model designed for outdoor applications. Included in the line is the Undercounter Model 315I(P) ice maker.

The Undercounter models accept a decorative door panel for an overlay or stainless steel application and can be built in to fit flush with virtually any base cabinet style. The outdoor Model UC-24RO is available in classic stainless steel only and comes with door panel and handle in place. Model UC-24RO must also be built-in into cabinetry and is not designed to be a free-standing unit.

A classic stainless steel door panel with handle is available as a sales accessory for Models UC-24R, UC-24C and 315I(P). Contact your Sub-Zero dealer for information on accessory panels and handles. Model UC-24B must be ordered as overlay (UC24-B/O) or stainless steel (UC-24B/S).

Sub-Zero Undercounter models are all backed by one of the best warranties in the industry.



Undercounter models, except Model 315I(P), are Star-K compliant to meet strict religious regulations in conjunction with specific instructions found on [www.star-k.org](http://www.star-k.org).

Comprehensive installation instructions are shipped with each model. Refer to those instructions in preparing and installing all Sub-Zero products. The instructions can also be found on our website, [subzero.com](http://subzero.com).

**NEW**

**ALL REFRIGERATOR**

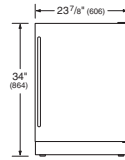

**MODEL UC-24R**

*All Refrigerator*

**NEW**

**BEVERAGE CENTER**

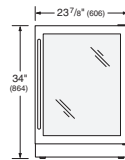

**MODEL UC-24B**

*Beverage Center*

**NEW**

**COMBINATION**

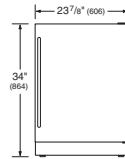

**MODEL UC-24C**

*Combination Refrigerator/Freezer*

**NEW**

**OUTDOOR MODEL**

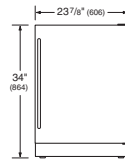

**MODEL UC-24RO**

*All Refrigerator*

**ICE MAKER**

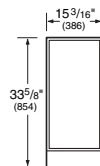

**MODEL 315I(P)**

*Ice Maker*

**SUB-ZERO WARRANTY**

Sub-Zero products are covered by a two, five and twelve year residential warranty (one and five year warranty for Model UC-24RO). See warranty details at the end of this guide.

Dimensions in parentheses are in millimeters unless otherwise specified.



**MODEL UC-24R** **NEW**

ALL REFRIGERATOR

*Energy Star Qualified*

**SPECIFICATIONS**

Overall Width	<b>23<sup>7</sup>/<sub>8</sub>" (606)</b>
Overall Height	<b>34" (864)</b>
Overall Depth	<b>24" (610)</b>
Refrigerator Capacity	<b>5.7 cu ft (161 L)</b>
Min Height Required	<b>34<sup>1</sup>/<sub>4</sub>" (870)</b>
Door Swing Clearance	<b>25<sup>3</sup>/<sub>8</sub>" (645)</b>
Specify Door Swing	<b>LH or RH</b>
Annual Energy Usage	<b>339 kWh   \$31*</b>
Shipping Weight	<b>130 lbs (59 kg)</b>

**FEATURES**

- 2 Adjustable Glass Shelves
- 1 Utility Bin
- 2 Door Shelves

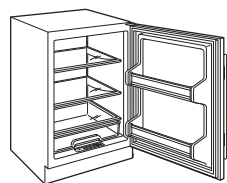

**MODEL UC-24R**

**MODEL UC-24B** **NEW**

BEVERAGE CENTER

**MODEL OPTIONS**

Overlay Design	<b>UC-24B/O</b>
Classic Stainless Steel	<b>UC-24B/S</b>
Full-View Glass Door (standard)	
High Altitude Glass Door**	

**SPECIFICATIONS**

Overall Width	<b>23<sup>7</sup>/<sub>8</sub>" (606)</b>
Overall Height	<b>34" (864)</b>
Overall Depth	<b>24" (610)</b>
Refrigerator Capacity	<b>5.7 cu ft (161 L)</b>
Wine Storage Capacity	<b>16 bottles***</b>
Min Height Required	<b>34<sup>1</sup>/<sub>4</sub>" (870)</b>
Door Swing Clearance	<b>25<sup>3</sup>/<sub>8</sub>" (645)</b>
Specify Door Swing	<b>LH or RH</b>
Annual Energy Usage	<b>424 kWh   \$39*</b>
Shipping Weight (O)	<b>130 lbs (59 kg)</b>
Shipping Weight (S)	<b>135 lbs (61 kg)</b>

**FEATURES**

- 2 Wine Storage Shelves
- 1 Adjustable Glass Shelf
- 1 Utility Bin

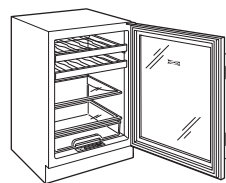

**MODEL UC-24B**

**MODEL UC-24C** **NEW**

COMBINATION REFRIGERATOR | FREEZER

*Available Fall 2007*

**SPECIFICATIONS**

Overall Width	<b>23<sup>7</sup>/<sub>8</sub>" (606)</b>
Overall Height	<b>34" (864)</b>
Overall Depth	<b>24" (610)</b>
Refrigerator Capacity	<b>3.6 cu ft (102 L)</b>
Wine Storage Capacity	<b>8 bottles***</b>
Freezer Capacity	<b>1.1 cu ft (31 L)</b>
Min Height Required	<b>34<sup>1</sup>/<sub>4</sub>" (870)</b>
Door Swing Clearance	<b>25<sup>3</sup>/<sub>8</sub>" (645)</b>
Specify Door Swing	<b>LH or RH</b>
Annual Energy Usage	<b>434 kWh   \$40*</b>
Shipping Weight	<b>130 lbs (59 kg)</b>

**FEATURES**

- 1 Wine Storage Shelf
- 1 Adjustable Glass Shelf
- 1 Door Shelf
- Automatic Defrost
- Automatic Ice Maker

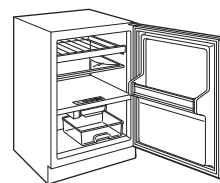

**MODEL UC-24C**

Dimensions in parentheses are in millimeters unless otherwise specified.

*\*Annual energy costs are based on 9.06 cents per kilowatt hour.*

*\*\*High altitude glass doors are for installations at or above 5,000' (1524 m) in elevation and will be treated as a special order. Please allow 90 days for delivery. When ordering, put an (A) after the (B) to obtain the correct model number.*

*\*\*750 ml bottles*

*Optional stainless steel panels and handles are ordered and shipped as sales accessories for Models UC-24R, UC-24C and 315(P).*



**MODEL UC-24RO** **NEW**

ALL REFRIGERATOR  
OUTDOOR MODEL

*Energy Star Qualified*  
*Available Summer 2007*

**SPECIFICATIONS**

Overall Width	<b>23<sup>7</sup>/<sub>8</sub>" (606)</b>
Overall Height	<b>34" (864)</b>
Overall Depth	<b>24" (610)</b>
Refrigerator Capacity	<b>5.7 cu ft (161 L)</b>
Min Height Required	<b>34<sup>1</sup>/<sub>4</sub>" (870)</b>
Door Swing Clearance	<b>25<sup>3</sup>/<sub>8</sub>" (645)</b>
Specify Door Swing	<b>LH or RH</b>
Annual Energy Usage	<b>339 kWh   \$31*</b>
Shipping Weight	<b>130 lbs (59 kg)</b>

**FEATURES**

- 2** Adjustable Glass Shelves
- 1** Utility Bin
- 2** Door Shelves
- Door Lock
- Classic Stainless Steel Finish

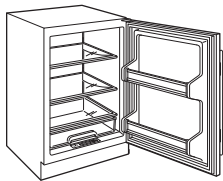

**MODEL UC-24RO**

**MODEL 315I**

ICE MAKER

**MODEL OPTIONS**

Drain Pump Model **315IP**

**SPECIFICATIONS**

Overall Width	<b>15<sup>3</sup>/<sub>16</sub>" (386)</b>
Overall Height	<b>33<sup>5</sup>/<sub>8</sub>" (854)</b>
Overall Depth	<b>24" (610)</b>
Ice Storage Capacity	<b>26 lbs (12 kg)</b>
Min Height Required	<b>33<sup>3</sup>/<sub>4</sub>" (857)</b>
Door Swing Clearance	<b>15<sup>1</sup>/<sub>4</sub>" (387)</b>
Shipping Weight	<b>100 lbs (45 kg)</b>

**FEATURES**

- Automatic Ice Maker
- Automatic Defrost
- Reversible Door Swing
- Drain Pump (Model 315IP)

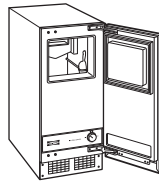

**MODEL 315I(P)**

**ACCESSORIES**

**Optional accessories are available through your Sub-Zero dealer. To obtain local dealer information, visit the Showroom Locator section of our website, [subzero.com](http://subzero.com).**

**ACCESSORIES**

*Contact your Sub-Zero Dealer*

**Classic stainless steel door front panel with tubular handle**

**Classic stainless steel tubular handle for overlay application**

**UL approved door lock**



## UNDERCOUNTER FEATURES

**Overlay Application.** The overlay application blends seamlessly into your overall room design and complements surrounding cabinetry. You add the decorative door front panel and hardware. Sub-Zero accessories handles are available. The overlay application is available for all Undercounter models except Model UC-24RO. Model UC-24B must be ordered specifically as overlay (UC24-B/O).

**Stainless Steel Application.** A classic stainless steel door front panel and handle is available as an accessory for Models UC-24R, UC-24C and 315I(P). Model UC-24B must be ordered specifically as stainless steel (UC-24B/S). Model UC-24RO is available as a classic stainless steel model only and comes with door panel and handle in place.

**Glass Door—Model UC-24B.** The full-view glass door and accent lighting of Model UC-24B matches the appearance of Wine Storage Model 424.

**Electronic Controls.** The electronic controls with digital readout LCD display are up front and easy to access—not applicable on Model 315I(P).

**Glass Shelves.** Cantilevered glass shelves are adjustable, easy to clean and spill proof. The glass floor is also spill proof.

**Utility Bin.** Refrigerator and combination units feature a clear utility bin for storage of smaller items.

**Wine Storage.** Models UC-24B and UC-24C feature wine storage of 16 and 8 (750 ml) bottles, respectively. The roller-glide wine storage shelves faced with natural cherry wood have a three-quarter extension for easy access.

**Automatic Ice Maker.** Combination Model UC-24C features an automatic ice maker with clear ice bucket. The ice maker provides high-quality, crescent-shaped ice that won't stick to the side of the glass.

**Two-Litre Bottle Storage.** Models UC-24B, UC-24R and UC-24RO feature two-litre bottle storage in the bottom door shelf.

**Door Lock.** A UL approved lock is standard on Model UC-24RO and available as a sales accessory for all other models except Model 315I(P).

**Sabbath Feature.** The Sabbath feature will allow the lights to remain off during certain religious observances—not applicable on Model 315I(P).

**Ice Maker.** Model 315I(P) provides high-quality, clear ice with a storage capacity of up to 26 lbs (12 kg). The ice is not crescent shaped, but instead resembles a small barrel.

**Drain.** Ice maker Model 315I has a gravity drain, while Model 315IP has a built-in pump to allow water to drain into adjacent sink.

SUB-ZERO  
WARRANTY

Sub-Zero products are covered by a two, five and twelve year residential warranty (one and five year warranty for Model UC-24RO). See warranty details at the end of this guide.

Dimensions in parentheses are in millimeters unless otherwise specified.



## PLANNING INFORMATION

Refer to the Installation Specifications for information regarding area requirements, minimum door clearance, placement of electrical and plumbing for Sub-Zero Undercounter models.

The Model 315I can be ordered with or without a pump. If you order the unit without a pump, you must install a drain. Refer to the illustrations on page 73. The drain must be located in a 2" (51) area centered in the opening for the unit, 23" (651) back from the front door.

## PLUMBING REQUIREMENTS

For Models UC-24C and 315I(P), rough in the water supply line. Connect a 1/4" OD copper line to the house supply with an easily accessible shut-off valve between the supply and the unit. A minimum of 26" (660) of copper tubing is required for the water line for Model UC-24C.

Do not use self-piercing valves. A saddle valve kit (4200880) is available from your Sub-Zero dealer. An in-line filter is required when water conditions have a high sediment content.

The ice maker operates on constant water pressure between 20 psi (1.4 bar) and 100 psi (6.9 bar).

**IMPORTANT NOTE:** In some cases, a reverse osmosis water filter system may not be able to maintain the minimum pressure consistently.

## ELECTRICAL REQUIREMENTS

A 115 V AC, 60 Hz, 15 amp circuit breaker and electrical supply are required. A separate circuit, servicing only this appliance is required.

All Undercounter models are equipped with a power supply cord with a 3-prong grounding plug, which must be plugged into a mating 3-prong grounding-type wall receptacle. Follow the National Electrical Code and local codes and ordinances when installing the receptacle. Refer to the Installation Specifications illustrations.

**IMPORTANT NOTE:** The Model UC-24RO is designed and safe for use in outdoor applications. When installed outdoors, a ground fault circuit interrupter (GFCI) is required to reduce the risk of electrical shock. A GFCI is not recommended for use with other Undercounter models and may cause interruption of operation.

## MODEL OPTIONS

**Model UC-24R**  
*All Refrigerator*

**Model UC-24B**  
*All Refrigerator  
Beverage Center*

**Model UC-24C**  
*Refrigerator / Freezer  
with Ice Maker*

**Model UC-24RO**  
*All Refrigerator  
Outdoor Model*

**Model 315IP**  
*Ice Maker with  
Drain Pump*



## UNDERCOUNTER REFRIGERATION

### INSTALLATION SPECIFICATIONS

*Models UC-24R, UC-24B, UC-24C and UC-24RO*

#### Overall Dimensions

Overall Width	<b>23<sup>7</sup>/<sub>8</sub>" (606)</b>
Overall Height	<b>34" (864)</b>
Overall Depth	<b>24" (610)</b>

#### Finished Opening Dimensions

Opening Width	<b>24" (610)</b>
Opening Height	<b>34<sup>1</sup>/<sub>2</sub>" (876)</b>
Opening Depth	<b>24" (610)</b>
Door Swing Clearance	<b>25<sup>3</sup>/<sub>8</sub>" (645)</b>

*Models without an ice maker will not require the water line connection.*

*Door swing clearance based on stainless steel door panel and handle dimensions.*

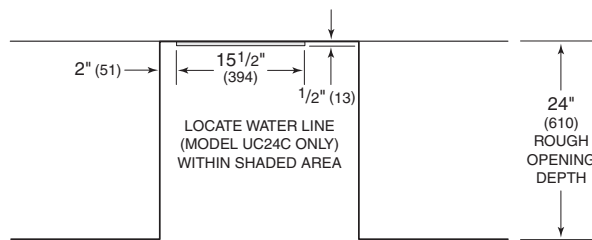
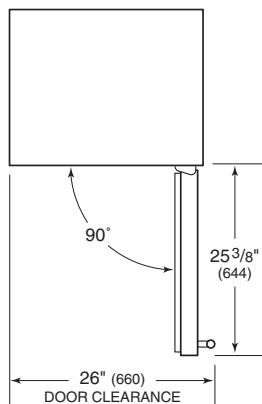

TOP VIEW

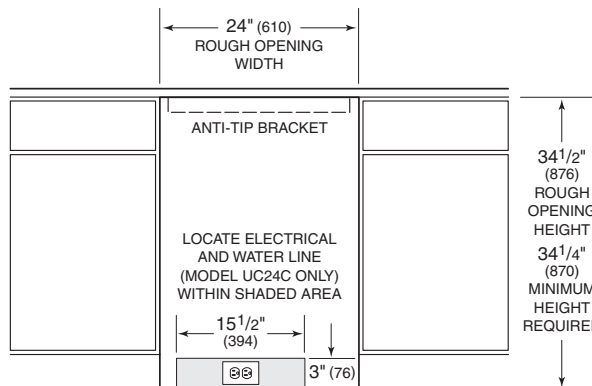

FRONT VIEW

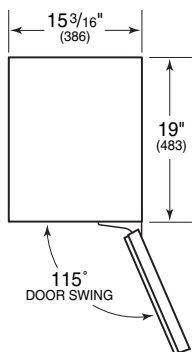

### INSTALLATION SPECIFICATIONS

*Model 315I(P)*

#### Overall Dimensions

Overall Width	<b>15<sup>3</sup>/<sub>16</sub>" (386)</b>
Overall Height	<b>33<sup>5</sup>/<sub>8</sub>" (854)</b>
Overall Depth	<b>24" (610)</b>

#### Finished Opening Dimensions

Opening Width	<b>15<sup>1</sup>/<sub>4</sub>" (387)</b>
Opening Height	<b>34<sup>1</sup>/<sub>2</sub>" (876)</b>
Opening Depth	<b>24" (610)</b>
Door Swing Clearance	<b>15<sup>1</sup>/<sub>4</sub>" (387)</b>

*Refer to the illustrations on the following page for additional specifications.*

*Door swing clearance based on stainless steel door panel and handle dimensions.*

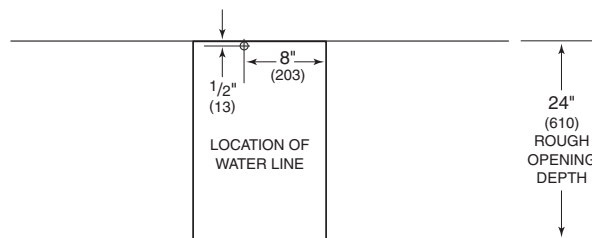

TOP VIEW

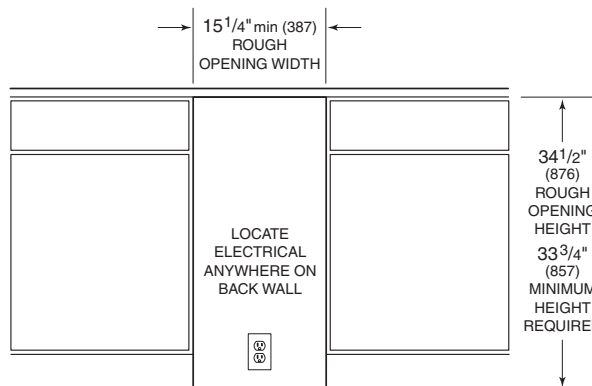

FRONT VIEW

Dimensions in parentheses are in millimeters unless otherwise specified.





**MODEL 315I(P) – GRAVITY DRAIN OR DRAIN PUMP**

The Undercounter ice maker can be ordered with a pump (Model 315IP) or without a pump (Model 315I). The model without a drain pump drains its water by gravity. However, the gravity drain model may be converted to a pump model through the installation of a drain pump kit and drain pump.

Specific step-by-step instructions are included with the drain pump kit. Contact your Sub-Zero dealer for specifics.

The drain and inlet water tubes must be plumbed before connecting to the ice maker. For the gravity drain, all horizontal runs of drain lines must have a 1/4" (6) per 12" (305) fall. An air gap will likely be required between the ice maker drain tube and the drain/waste receptacle. A stand pipe with a trap below it would be acceptable for the drain/waste receptacle. Refer to the illustrations below.

**IMPORTANT NOTE:** Poor drainage will cause a high rate of ice melting in the bin.

ACCESSORIES

Optional accessories are available through your Sub-Zero dealer. To obtain local dealer information, visit the Showroom Locator section of our website, [subzero.com](http://subzero.com).

INSTALLATION SPECIFICATIONS

*Model 315I - Gravity Drain*

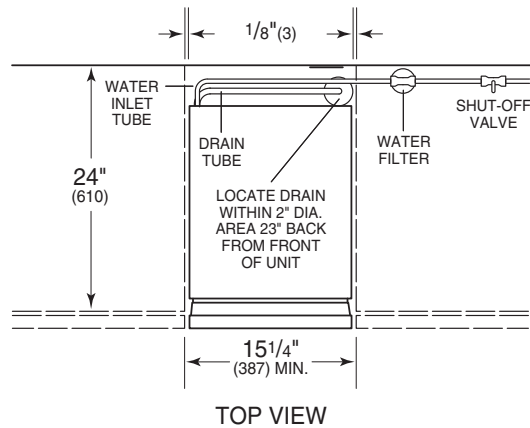

*Model 315IP - Drain Pump*

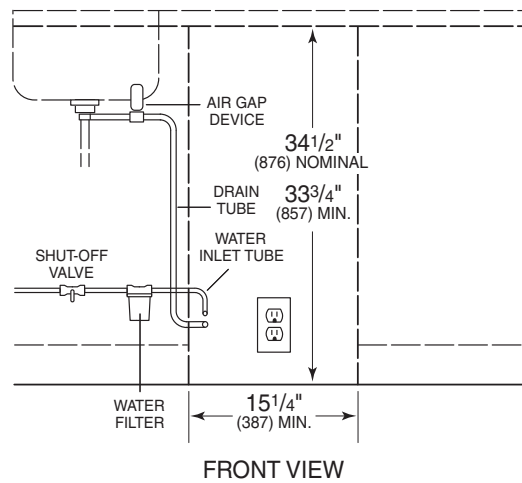
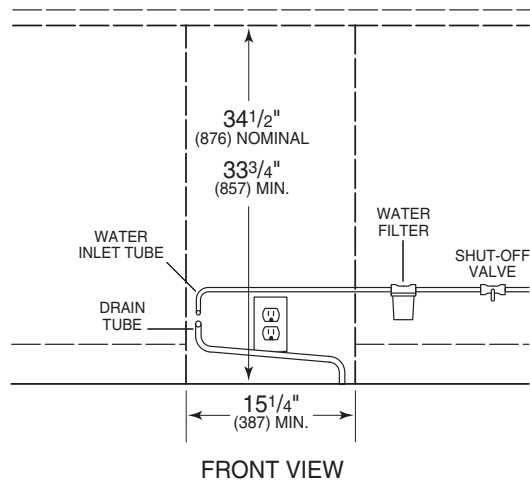
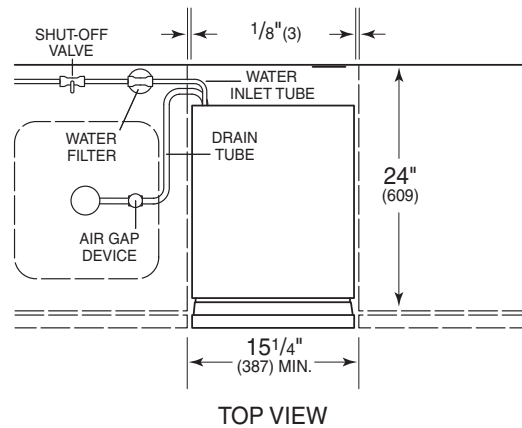

Refer to installation instructions shipped with each Wolf product for detailed specifications.



**OVERLAY PANEL – MODELS UC-24R AND UC-24C**

The overlay door panel design allows for a decorative panel to cover the door trim for a seamless appearance that will compliment surrounding cabinetry. You may also choose to match the handle hardware of surrounding cabinetry.

Refer to the Overlay Panel Specifications below for the panel dimensions of your specific model. Outdoor Model UC-24RO is available as a classic stainless steel model only and comes with door panel and handle in place.

**OVERLAY PANEL – MODEL UC-24B**

The overlay door panel applied to the Model UC-24B will consist of only a frame and will affix directly to the door with screws through a series of predrilled holes in the perimeter of the door.

The glass door opening of the Model UC-24B is designed to be exposed to room air circulation. Decorative overlays on the glass should be kept to a minimum. Refer to the Overlay Panel Specifications below for panel dimensions.

Rails and stiles must be a minimum of 2<sup>1</sup>/<sub>4</sub>" (57) wide. They can be increased in size but should not exceed cabinet manufacturers standard width. Rails and stiles cannot exceed the overall door panel dimensions specified, as they would interfere with the operation of the door. The back sides of rails and stiles that will be visible through the glass door will need to be finished. Also, the inside edges of the frames must be finished to match the front surface.

**⚠ CAUTION**  
**A solid panel must not be installed on a glass door unit, as this may cause moisture to form behind the panel.**

**OVERLAY PANEL – MODEL 315I(P)**

It is important to understand the differences in mounting any wood panel to the Model 315I(P). Refer to the Overlay Panel Specifications below for panel dimensions. Also refer to the installation instructions packaged with the unit to understand how the panel is installed.

INSTALLATION

To install framed or overlay panels, see the detailed procedures outlined in the Sub-Zero Under-counter Installation Instructions.

Refer to the full-scale illustrations at the end of this section for specifics on door openings and other specifications.

OVERLAY PANEL SPECIFICATIONS  
*Undercounter Models*

**Models UC-24R and UC-24C**

Door Panel Width	<b>23<sup>3</sup>/<sub>4</sub>" (603)</b>
Door Panel Height	<b>30<sup>1</sup>/<sub>16</sub>" (764)</b>
Panel Thickness	<b>5/<sub>8</sub>" (16) min</b>
Panel Weight Limit	<b>20 lbs (9 kg) max</b>

**Model UC-24B**

Door Panel Width	<b>23<sup>3</sup>/<sub>4</sub>" (603)</b>
Door Panel Height	<b>30<sup>1</sup>/<sub>16</sub>" (764)</b>
Width of Rails and Stiles	<b>2<sup>1</sup>/<sub>4</sub>" (57) min</b>
Panel Thickness	<b>5/<sub>8</sub>" (16) min</b>
Panel Weight Limit	<b>10 lbs (5 kg) max</b>

**Model 315I(P)**

Door Panel Width	<b>15" (381)</b>
Door Panel Height	<b>30<sup>3</sup>/<sub>8</sub>" (772)</b>
Panel Thickness	<b>5/<sub>8</sub>" (16) min</b>
Panel Weight Limit	<b>15 lbs (7 kg) max</b>

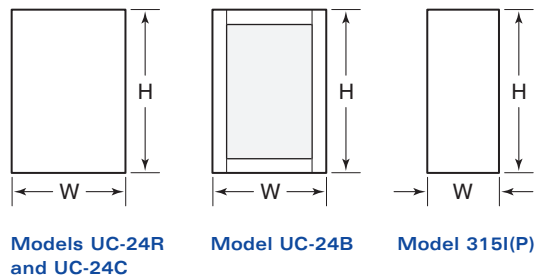

Dimensions in parentheses are in millimeters unless otherwise specified.



DOOR FRAME PROFILE – MODEL UC-24B

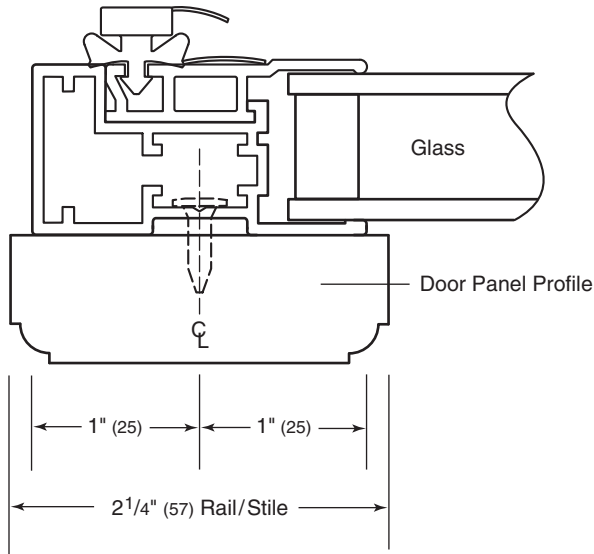

The full-scale illustration shows the door frame profile for Model UC-24B.

**IMPORTANT NOTE:** Rails and stiles must be a minimum of 2 1/4" (57) wide. The back sides of rails and stiles that will be visible through the glass door will need to be finished.

FULL-SCALE TEMPLATES

The full-scale illustrations on the following pages enable you to understand some of the unique situations you may face as you plan for the installation of the Undercounter units. Use these illustrations as templates.

DOOR FRAME PROFILE

WINE SHELF WOOD FACING – MODELS UC-24B AND UC-24C

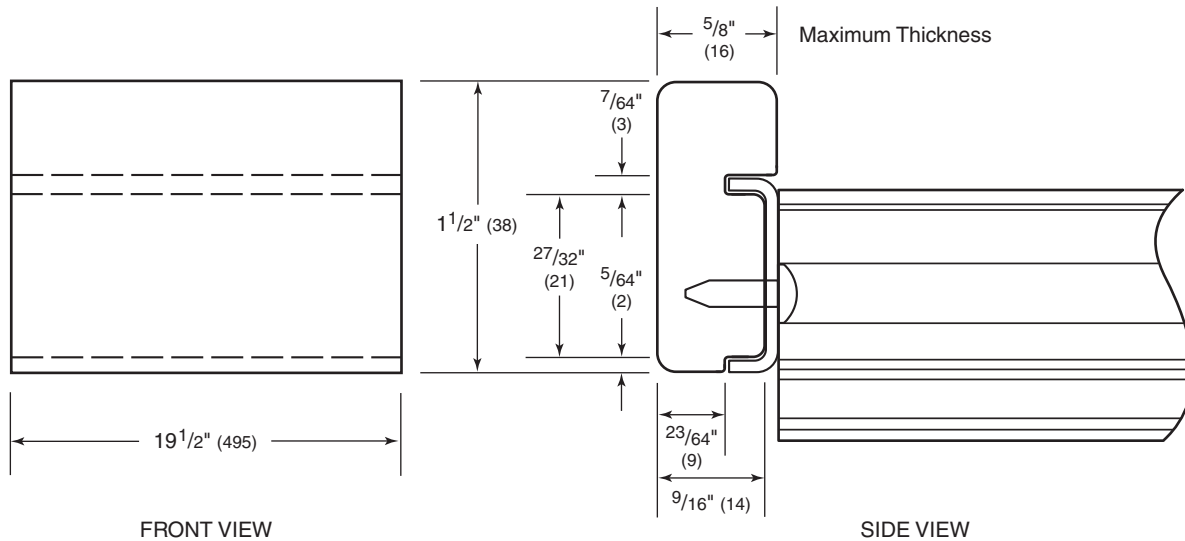

FRONT VIEW

SIDE VIEW

For Models UC-24B and UC-24C, use the full-scale illustration above as a template if you choose to replace the natural cherry wood facing with wood more complementary to your design and surrounding cabinetry.



UNDERCOUNTER DOOR CLOSED AND 145° MAX OPENING

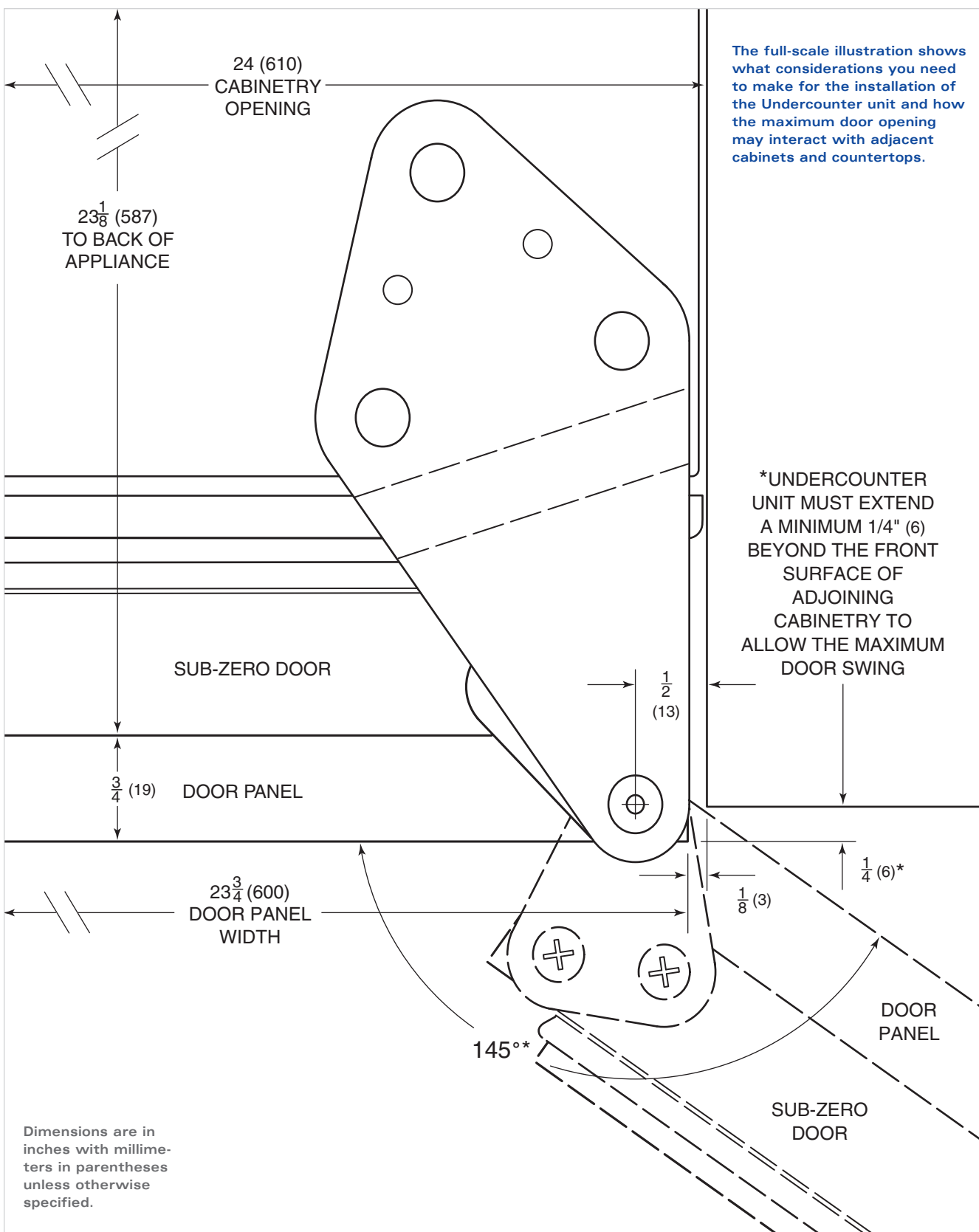

# SUB-ZERO PRODUCTS LIMITED WARRANTY

RESIDENTIAL USE ONLY

## FULL FIVE YEAR SEALED SYSTEM WARRANTY LIMITED SIXTH THROUGH TWELFTH YEAR WARRANTY ON THE SEALED SYSTEM FULL TWO YEAR WARRANTY ON TOTAL PRODUCT\*

### FULL FIVE YEAR SEALED SYSTEM WARRANTY

For five years from the date of original installation, your Sub-Zero warranty covers all parts and labor to repair or replace any components that prove to be defective in materials or workmanship in the sealed system. The sealed system consists of the compressor, condenser, evaporator, drier and all connecting tubing.

### FULL TWO YEAR WARRANTY\*

For two years from the date of original installation, your Sub-Zero warranty covers all parts and labor to repair or replace any part of the product, that proves to be defective in materials or workmanship.

### LIMITED SIXTH THROUGH TWELFTH YEAR SEALED SYSTEM WARRANTY

From the 6th through the 12th year from the date of original installation, your Sub-Zero warranty covers all parts that prove to be defective in materials or workmanship in the sealed system (parts only). The sealed system consists of the compressor, condenser, evaporator, drier and all connecting tubing.

### TERMS APPLICABLE TO EACH WARRANTY

All service provided by Sub-Zero under the above warranty must be performed by an authorized Sub-Zero service center, unless otherwise specified by Sub-Zero. Service will be provided in the home during the normal business hours. This warranty applies only to products installed for normal residential use. Details regarding a non-residential warranty are available upon request.

The warranty applies only to products installed in any one of the fifty states of the United States, the District of Columbia or the ten provinces of Canada. This warranty does not cover any parts or labor to correct any defect caused by negligence, accident or improper use, maintenance, installation, service or repair, including but not limited to improper removal and reinstallation (whether in the unit or at a remote location) of the condensing unit.

**THE REMEDIES DESCRIBED ABOVE FOR EACH WARRANTY ARE THE ONLY ONES THAT SUB-ZERO WILL PROVIDE, EITHER UNDER THESE WARRANTIES OR UNDER ANY WARRANTY ARISING BY OPERATION OF LAW. SUB-ZERO WILL NOT BE RESPONSIBLE FOR ANY CONSEQUENTIAL OR INCIDENTAL DAMAGES ARISING FROM THE BREACH OF THESE WARRANTIES OR ANY OTHER WARRANTIES, WHETHER EXPRESS, IMPLIED OR STATUTORY.**

Some states do not allow the exclusion or limitation of incidental or consequential damages, so the above limitation or exclusion may not apply to you. This warranty gives you specific legal rights and you may also have other legal rights, which vary from state to state.

To receive parts and/or service and the name of the Sub-Zero authorized service center nearest you, contact your Sub-Zero dealer, distributor or the Sub-Zero Customer Service Department, P.O. Box 44130, Madison Wisconsin, 53744-4130; check the Constant Care section of our website, [subzero.com](http://subzero.com), or call 800-222-7820.

\* Stainless Steel (classic, platinum and carbon) doors, panels, product frames and stainless interior surfaces are covered by a limited 60 day parts and labor warranty for cosmetic defects.

\* Replacement water filter cartridges are not covered by the product warranty.



## **SUB-ZERO OUTDOOR PRODUCTS LIMITED WARRANTY**

RESIDENTIAL USE ONLY

### **FULL FIVE YEAR SEALED SYSTEM WARRANTY FULL ONE YEAR WARRANTY ON TOTAL PRODUCT\***

#### **FULL FIVE YEAR SEALED SYSTEM WARRANTY**

For five years from the date of original installation, your Sub-Zero warranty covers all parts and labor to repair or replace any components that prove to be defective in materials or workmanship in the sealed system. The sealed system consists of the compressor, condenser, evaporator, drier and all connecting tubing.

#### **FULL ONE YEAR WARRANTY\***

For one year from the date of original installation, your Sub-Zero warranty covers all parts and labor to repair or replace any part of the product which proves to be defective in materials or workmanship.

#### **TERMS APPLICABLE TO EACH WARRANTY**

All service provided by Sub-Zero under the above warranty must be performed by an authorized Sub-Zero service center, unless otherwise specified by Sub-Zero. Service will be provided in the home during the normal business hours. This warranty applies only to products installed for normal residential use. Details regarding a non-residential warranty are available upon request.

The warranty applies only to products installed in any one of the fifty states of the United States, the District of Columbia or the ten provinces of Canada. This warranty does not cover any parts or labor to correct any defect caused by negligence, accident or improper use, maintenance, installation, service or repair, including but not limited to improper removal and reinstallation (whether in the unit or at a remote location) of the condensing unit.

**THE REMEDIES DESCRIBED ABOVE FOR EACH WARRANTY ARE THE ONLY ONES THAT SUB-ZERO WILL PROVIDE, EITHER UNDER THESE WARRANTIES OR UNDER ANY WARRANTY ARISING BY OPERATION OF LAW. SUB-ZERO WILL NOT BE RESPONSIBLE FOR ANY CONSEQUENTIAL OR INCIDENTAL DAMAGES ARISING FROM THE BREACH OF THESE WARRANTIES OR ANY OTHER WARRANTIES, WHETHER EXPRESS, IMPLIED OR STATUTORY.**

Some states do not allow the exclusion or limitation of incidental or consequential damages, so the above limitation or exclusion may not apply to you. This warranty gives you specific legal rights and you may also have other legal rights which vary from state to state.

To receive parts and/or service and the name of the Sub-Zero authorized service center nearest you, contact your Sub-Zero dealer, distributor or the Sub-Zero Customer Service Department, P.O. Box 44130, Madison Wisconsin, 53744-4130; check the Constant Care section of our website, [subzero.com](http://subzero.com), or call 800-222-7820.

\*Stainless Steel (classic finish) doors, panels, product frames and stainless interior surfaces are covered by a limited 60 day parts and labor warranty for cosmetic defects.



The information and images in this guide are the copyright property of Sub-Zero, Inc. Neither this book nor any information or images contained herein may be copied or used in whole or in part without the express written permission of Sub-Zero, Inc.

©Sub-Zero, Inc. all rights reserved.



SUB-ZERO, INC.

P. O. BOX 44130  
MADISON, WI 53744-4130  
800.222.7820  
SUBZERO.COM

