

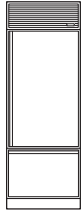

### Model 611 Over-and-Under Refrigerator | Freezer



BUILT-IN



Model 611/F  
Framed

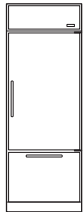

Model 611/O  
Overlay

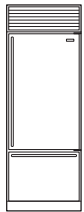

Model 611/S (P/B)  
Stainless Steel

Front venting allows unit to be completely built in

Lighted electronic control panel

Adjustable spill-proof glass shelves

Adjustable roll-out utility basket

Egg container

High humidity crisper drawer

Automatic ice maker

Two-tier wire storage baskets

Removable kickplate

Hermetically sealed refrigeration units

Serial and model number plate

Adjustable dairy compartment

Adjustable door shelves

Four-sided magnetic gaskets

Door closers

Full-extension roll-out freezer drawer



With the installation of a harness kit, these appliances are Star-K compliant to meet strict religious regulations in conjunction with specific instructions found on [star-k.org](http://star-k.org). You may purchase this harness kit through your Sub-Zero dealer. To obtain local dealer information, visit the Locator section of our website, [subzero.com](http://subzero.com).

► The Sub-Zero Model 611 over-and-under refrigerator/freezer is available in your choice of the framed, overlay or stainless steel design application. Three stainless steel finishes are offered—classic (S), platinum (P) and carbon (B).

This is the smallest combination refrigerator/freezer unit that Sub-Zero offers in the Built-In line. The 30" (762) width enables this model to be installed in the smallest galley kitchen and, when paired with another 611, offers plenty of storage space for your entire home needs.

Dimensions in parentheses are in millimeters unless otherwise specified.



## Model 611

### FEATURES

- ▶ 30" (762) wide over-and-under refrigerator / freezer
- ▶ Energy Star qualified
- ▶ Framed, overlay and stainless steel applications provide complete design flexibility
- ▶ Sub-Zero's dual refrigeration system ensures the freshest food and energy efficiency
- ▶ Shallow-depth design means access is easy to any area of the refrigerator
- ▶ Electronic digital controls are up front and easy to use
- ▶ Bright interior lighting
- ▶ Adjustable spill-proof glass shelves in the refrigerator
- ▶ High humidity crisper drawer is large and deep with removable divider and smooth sides for easy cleaning
- ▶ Full-extension freezer drawer
- ▶ Door alarm will let you know with an audible beeping if your refrigerator door or freezer drawer are left ajar
- ▶ Automatic ice maker provides an ample supply of crescent-shaped ice
- ▶ Solid core door and drawer with magnetic gaskets and door/drawer closers
- ▶ Front venting allows unit to be completely built in and serviced from the front
- ▶ UL approved for US and Canada
- ▶ Two, five and twelve year residential warranty – exclusions apply; warranty information can be found on our website, [subzero.com](http://subzero.com)

### OVERALL DIMENSIONS ▼

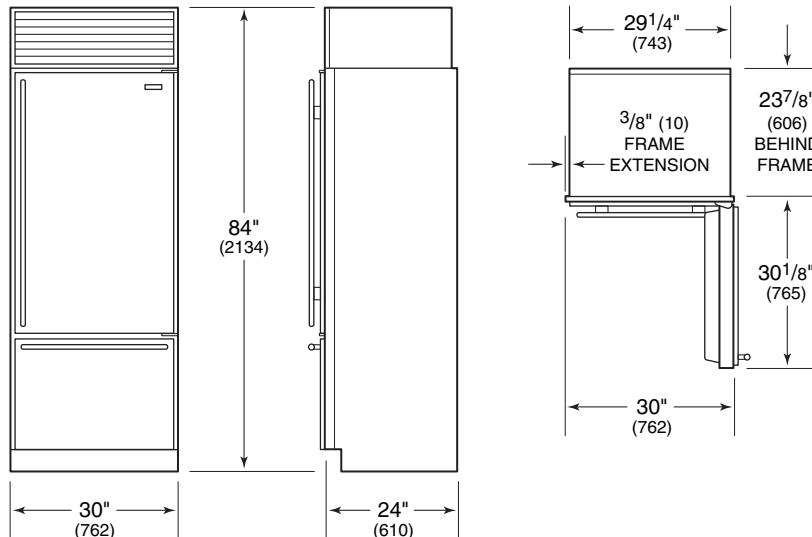

BUILT-IN

*Stainless steel design shown.*

*Dimensions may vary by ± 1/8" (3).*

*Dimensions in parentheses are in millimeters unless otherwise specified.*



## Model 611



BUILT-IN

### MODEL OPTIONS

Framed Design	611/F
Overlay Design	611/O
Classic Stainless Steel	611/S
Platinum Stainless Steel	611/P
Carbon Stainless Steel	611/B

*You must allow 90 days from order to delivery for platinum and carbon finishes.*

### ACCESSORIES

- ▶ Louvered, panel or stainless steel grilles in 1" (25) increments from 10" (254) to 15" (381) high
- ▶ Front and grille panels for framed design in white, almond and classic stainless steel
- ▶ Side panels in white, almond and classic stainless steel
- ▶ Extended framed handles
- ▶ Stainless steel and polished chrome handles for overlay design
- ▶ Gallon door shelf
- ▶ Dozen egg container with lid

*Accessories are available through your Sub-Zero dealer. To obtain local dealer information, visit the Locator section of our website, [subzero.com](http://subzero.com).*

### SPECIFICATIONS

Model 611	Over-and-Under Refrigerator/Freezer
Overall Width	30" (762)
Overall Height	84" (2134)
Overall Depth	24" (610)
Refrigerator Capacity	12.7 cu ft (360 L)
Freezer Capacity	3.9 cu ft (110 L)
Minimum Height (levelers in)	83" (2108)
Door Swing Clearance	30 1/8" (765)
Electrical Requirements	115 V AC, 60 Hz, 15 amp circuit
Plumbing Requirements	1/4" copper line
Water Supply	20-100 psi
Annual Energy Usage (based on 8.29 cents per kilowatt hour)	463 kWh / \$39
Energy Star Qualified	
Shipping Weight	Framed - 430 lbs (195 kg) Overlay - 430 lbs (195 kg) Stainless Steel - 462 lbs (210 kg)
Special Note	Model 611 can also be ordered with a glass door as Model 611G

*Specifications are subject to change without notice.*

Model 611

INSTALLATION SPECIFICATIONS



BUILT-IN

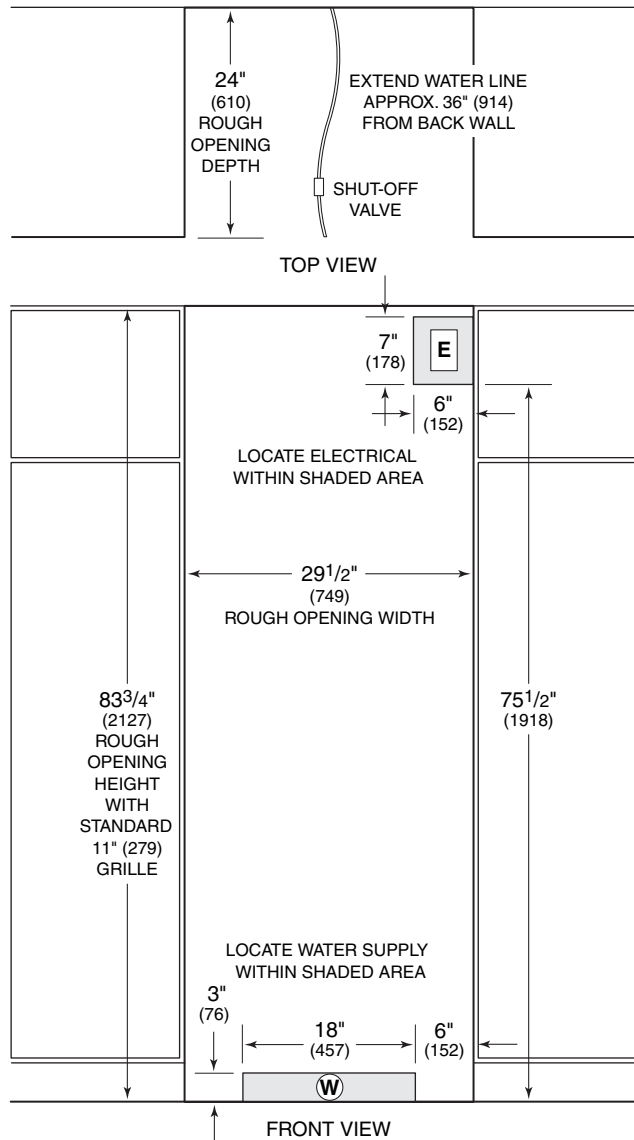

Dimensions may vary by  $\pm 1/8"$  (3).

DIMENSIONS

Finished Rough Opening Width	29 1/2" (749)
Finished Rough Opening Height	83 3/4" (2127)
Finished Rough Opening Depth	24" (610)
Location of Electrical	Within upper shaded area
Location of Water Supply	Within lower shaded area

See Installation Instructions shipped with unit for detailed specifications.  
Refer to the Sub-Zero Design Guide pdf file for additional specifications.

Dimensions in parentheses are in millimeters unless otherwise specified.



## Model 611

### INSTALLATION NOTES

- ▶ Refer to the illustrations and specifications for overall dimensions, finished rough opening dimensions and installation specifics.
- ▶ Allow the door to open a minimum of 90° or you'll have problems removing drawers. With the door opening at 90°, you may have to move drawers slightly to clear the door interior. Refer to the minimum door swing clearance in the specifications chart.
- ▶ For corner installations, allow for a minimum 3" (76) filler so that the door can open to 90°. If you're using raised panels, consider using a wider filler.
- ▶ Refer to the full-scale illustrations at the end of this section for specifics on door openings and filler size alternatives.
- ▶ If your client has chosen the stainless steel design, the unit will be shipped complete with wrapped stainless steel doors and handle hardware. You will not have to install front panels.
- ▶ If your client has chosen the framed or overlay design, you will be adding front panels to give the unit the custom Sub-Zero look. For the overlay design, handles are not provided with the unit. Your own handles can be used or you can obtain accessory handles through your Sub-Zero dealer.
- ▶ For Built-In models with an automatic ice maker, rough in the water supply line. Connect a 1/4" OD copper line to the house supply, being sure to use an easily accessible shut off valve between the supply and the unit.
- ▶ Do not use self-piercing valves. A saddle valve kit (4200880) is available from your Sub-Zero dealer. To obtain local dealer information, visit the Locator section of our website, [subzero.com](http://subzero.com).
- ▶ A line filter is required when water conditions have a high sediment content. The ice maker operates on water pressure of 20 psi (1.4 bar) to 100 psi (6.9 bar). In some cases a reverse osmosis water filter system may not be able to maintain the minimum water pressure consistently.
- ▶ The water line should be routed up through the floor within 1/2" (13) from the back wall and no higher than 3" (76) off the floor. If you have to come through the wall, make sure the water line is no more than 3" (76) from the floor. Locate water supply within the shaded area shown in the installation illustration.
- ▶ Regardless of the routing, allow 3' (.9 m) of excess copper tubing to remain outside the wall or floor for easy connection to the unit.
- ▶ A 115 volt, 60 Hz, 15 amp electrical supply is required. The supply circuit for this appliance must be protected by a 15 amp fuse or circuit breaker. It is recommended that a separate circuit, serving only this appliance, be provided.
- ▶ All Built-In models are equipped with a 6' (1.8 m) power supply cord with a 3-prong grounding plug which must be plugged into a mating 3-prong grounding type wall receptacle. Locate electrical within the shaded area shown in the installation illustration.
- ▶ You must follow all National Electrical Code regulations. In addition, be aware of local codes and ordinances when installing your service.
- ▶ To prevent the unit from tipping forward and provide a stable installation, the unit must be secured in place with an anti-tip blocking kit. If there is a solid soffit above the unit with clearance between the unit and the soffit of 1" (25) or less, you won't need to block the unit.
- ▶ For installations with clearances of more than 1" (25), you must block the unit with the anti-tip blocking kit (wood block and hardware) provided with each Built-In unit.
- ▶ Refer to the Built-In Installation Instructions packed with the appliance, which provides step-by-step procedures for making sure the unit is installed properly.

**Model 611**  
**PANEL SPECIFICATIONS**



BUILT-IN

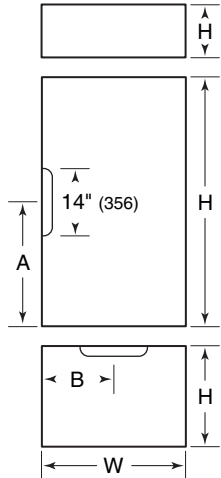

- ▶ Framed Door Panels
- ▶ Framed Grille Panel

**FRAMED PANELS**

An 11" (279) louvered grille is standard on framed applications. Optional louvered grilles are available in 1" (25) height increments from 10" (254) to 15" (381).

You may choose to use Sub-Zero's optional panel grille for the framed application. Optional panel grilles are available in 1" (25) height increments from 10" (254) to 15" (381). Refer to the chart below for panel dimensions.

**FRAMED PANEL DIMENSIONS** ▼

	WIDTH	HEIGHT
Refrigerator Door Panel	28 <sup>1</sup> / <sub>8</sub> " (714)	48 <sup>1</sup> / <sub>16</sub> " (1221)
Freezer Door Panel	28 <sup>1</sup> / <sub>8</sub> " (714)	18 <sup>3</sup> / <sub>8</sub> " (467)
Handle Recess Location		A – 24 <sup>1</sup> / <sub>32</sub> " (610) B – 14 <sup>1</sup> / <sub>16</sub> " (357)
Maximum Weight (per panel)		50 lbs (23 kg)

**FRAMED GRILLE PANEL DIMENSIONS** ▼

	WIDTH	HEIGHT
10" (254) Grille	28 <sup>3</sup> / <sub>16</sub> " (716)	8 <sup>15</sup> / <sub>16</sub> " (227)
11" (279) Grille	28 <sup>3</sup> / <sub>16</sub> " (716)	9 <sup>15</sup> / <sub>16</sub> " (252)
12" (305) Grille	28 <sup>3</sup> / <sub>16</sub> " (716)	10 <sup>15</sup> / <sub>16</sub> " (278)
13" (330) Grille	28 <sup>3</sup> / <sub>16</sub> " (716)	11 <sup>15</sup> / <sub>16</sub> " (303)
14" (356) Grille	28 <sup>3</sup> / <sub>16</sub> " (716)	12 <sup>15</sup> / <sub>16</sub> " (329)
15" (381) Grille	28 <sup>3</sup> / <sub>16</sub> " (716)	13 <sup>15</sup> / <sub>16</sub> " (354)

## Model 611 PANEL SPECIFICATIONS



BUILT-IN

### FRAMED PANELS ▼

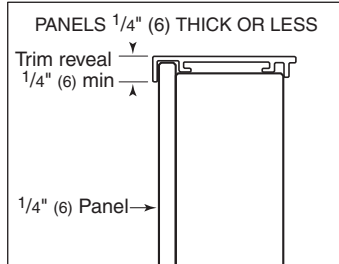

► Framed door panel  $\frac{1}{4}$ " (6) thick or less

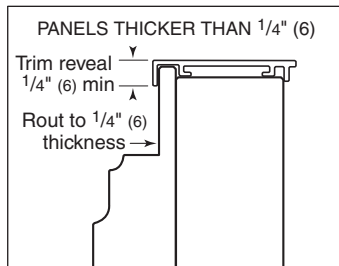

► Framed door panel thicker than  $\frac{1}{4}$ " (6)

### FRAMED PANELS

If the thickness of the custom panels is less than  $\frac{1}{4}$ " (6), they must be backed up with a sheet of shim material to build the total thickness to  $\frac{1}{4}$ " (6). If the panel is thicker than  $\frac{1}{4}$ " (6), an edge must be routed around the panel to ensure a proper fit. Refer to the illustrations on this page.

**IMPORTANT NOTE:** Routing, recessing or optional extended handles may be required on raised panels for finger clearance under the handle. Refer to the full-scale illustrations at the end of this section.

**IMPORTANT NOTE:** The weight of each panel cannot exceed 50 lbs (23 kg).

The traditional framed models come with an 11" (279) louvered grille and elegant full-length handle. Optional extended full-length handles that provide additional finger clearance for raised panels are available through your Sub-Zero dealer. To obtain local dealer information, visit the Locator section of our website, [subzero.com](http://subzero.com).

For framed door panel dimensions and dimensions for the optional panel grille for the framed application, refer to specifications on page 6.

To install framed panels, refer to the installation instructions shipped with each unit. These instructions can also be found on our website, [subzero.com](http://subzero.com).

## Model 611 PANEL SPECIFICATIONS



BUILT-IN

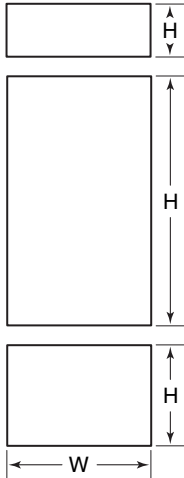

- ▶ Overlay Door Panels
- ▶ Overlay Grille Panel

▶ **IMPORTANT NOTE:** The overlay refrigerator door panel will require a recessed area to prevent the unit's lower hinge plate from hitting the door panel.

### OVERLAY PANELS

An 11" (279) panel grille is standard on overlay applications. Optional panel grilles are available in 1" (25) height increments from 10" (254) to 15" (381).

### OVERLAY PANEL DIMENSIONS ▼

	WIDTH	HEIGHT
Refrigerator Door Panel	28 <sup>7</sup> / <sub>16</sub> " (722)	48 <sup>7</sup> / <sub>8</sub> " (1241)
Refrigerator Door Spacer	27 <sup>1</sup> / <sub>2</sub> " (699)	47 <sup>7</sup> / <sub>16</sub> " (1205)
Refrigerator Door Backer	28 <sup>1</sup> / <sub>8</sub> " (714)	48 <sup>1</sup> / <sub>16</sub> " (1221)
Freezer Door Panel	28 <sup>7</sup> / <sub>16</sub> " (722)	18 <sup>11</sup> / <sub>16</sub> " (475)
Freezer Door Spacer	27 <sup>1</sup> / <sub>2</sub> " (699)	17 <sup>3</sup> / <sub>4</sub> " (451)
Freezer Door Backer	28 <sup>1</sup> / <sub>8</sub> " (714)	18 <sup>3</sup> / <sub>8</sub> " (467)
Maximum Weight (per panel assembly)		50 lbs (23 kg)

### OVERLAY GRILLE PANEL DIMENSIONS ▼

	WIDTH	HEIGHT
10" (254) Grille Panel	28 <sup>7</sup> / <sub>16</sub> " (722)	9 <sup>1</sup> / <sub>4</sub> " (235)
10" (254) Grille Spacer	27 <sup>1</sup> / <sub>2</sub> " (699)	8 <sup>5</sup> / <sub>16</sub> " (211)
10" (254) Grille Backer	28 <sup>1</sup> / <sub>8</sub> " (714)	8 <sup>15</sup> / <sub>16</sub> " (227)
11" (279) Grille Panel	28 <sup>7</sup> / <sub>16</sub> " (722)	10 <sup>1</sup> / <sub>4</sub> " (260)
11" (279) Grille Spacer	27 <sup>1</sup> / <sub>2</sub> " (699)	9 <sup>5</sup> / <sub>16</sub> " (237)
11" (279) Grille Backer	28 <sup>1</sup> / <sub>8</sub> " (714)	9 <sup>15</sup> / <sub>16</sub> " (252)
12" (305) Grille Panel	28 <sup>7</sup> / <sub>16</sub> " (722)	11 <sup>1</sup> / <sub>4</sub> " (286)
12" (305) Grille Spacer	27 <sup>1</sup> / <sub>2</sub> " (699)	10 <sup>5</sup> / <sub>16</sub> " (262)
12" (305) Grille Backer	28 <sup>1</sup> / <sub>8</sub> " (714)	10 <sup>15</sup> / <sub>16</sub> " (278)
13" (330) Grille Panel	28 <sup>7</sup> / <sub>16</sub> " (722)	12 <sup>1</sup> / <sub>4</sub> " (311)
13" (330) Grille Spacer	27 <sup>1</sup> / <sub>2</sub> " (699)	11 <sup>5</sup> / <sub>16</sub> " (287)
13" (330) Grille Backer	28 <sup>1</sup> / <sub>8</sub> " (714)	11 <sup>15</sup> / <sub>16</sub> " (303)
14" (356) Grille Panel	28 <sup>7</sup> / <sub>16</sub> " (722)	13 <sup>1</sup> / <sub>4</sub> " (337)
14" (356) Grille Spacer	27 <sup>1</sup> / <sub>2</sub> " (699)	12 <sup>5</sup> / <sub>16</sub> " (313)
14" (356) Grille Backer	28 <sup>1</sup> / <sub>8</sub> " (714)	12 <sup>15</sup> / <sub>16</sub> " (329)
15" (381) Grille Panel	28 <sup>7</sup> / <sub>16</sub> " (722)	14 <sup>1</sup> / <sub>4</sub> " (362)
15" (381) Grille Spacer	27 <sup>1</sup> / <sub>2</sub> " (699)	13 <sup>5</sup> / <sub>16</sub> " (338)
15" (381) Grille Backer	28 <sup>1</sup> / <sub>8</sub> " (714)	13 <sup>15</sup> / <sub>16</sub> " (354)



**Model 611**  
**PANEL SPECIFICATIONS**



BUILT-IN

**OVERLAY PANELS** ▼

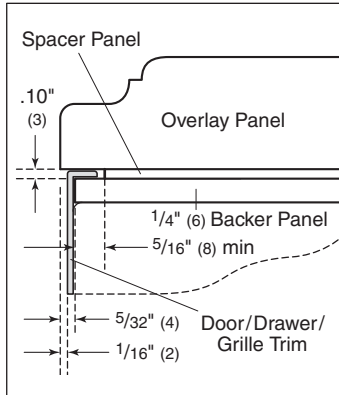

► Three panel assembly—cross section

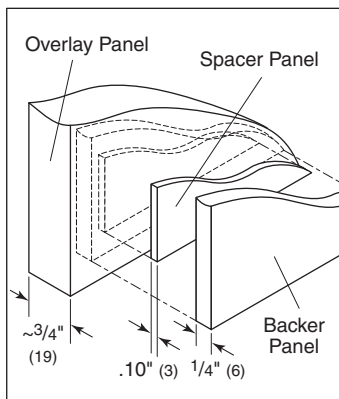

► Three panel assembly—rear view

**OVERLAY PANELS**

The overlay design allows decorative panels to cover the door trim for a more seamless appearance that blends with the design of the room. To achieve this look, the most common way is to work with three panels—the decorative overlay panel, a .10" (3) spacer panel and a 1/4" (6) backer panel. Depending on your cabinet manufacturer, this could be one panel routed for different dimensions or more likely, three different panels.

Regardless of the physical construction of the panels (routing or three panel assembly), you will need to follow the exact dimensions and panel placement to ensure a proper fit.

The top illustration on this page is a cross section view of the three panel assembly showing placement of the door/drawer/grille trim. The bottom illustration shows a rear view of the three panel assembly and critical dimensions, standard for all overlay models.

Overlay models will come with no handle hardware, because the beauty of this design is that you can match the surrounding cabinetry hardware. These models will come with an 11" (279) panel grille which will accept decorative panel inserts to match the look of the door panels. For overlay door and grille panel dimensions, refer to specifications on page 8.

**IMPORTANT NOTE:** Keep in mind that the Sub-Zero door panels have the potential for hitting adjacent cabinets and/or countertops when they are opened. You need to be aware of your surrounding cabinetry and space limitations when using the overlay models. Refer to the full-scale illustrations at the end of this section.

**IMPORTANT NOTE:** The weight of each door panel assembly cannot exceed 50 lbs (23 kg). The total thickness of all panels for an overlay model must be at least 5/8" (16) thick.

To install overlay panels, refer to the installation instructions shipped with each unit. These instructions can also be found on our website, [subzero.com](http://subzero.com).

**⚠ CAUTION**

**Do not exceed the dimensions listed for the overlay grille panel. The decorative panel cannot be any larger or it may restrict the air flow to the compressor area and cause problems with the operation of the unit.**

## Model 611 PANEL SPECIFICATIONS



BUILT-IN

### OVERLAY PANELS ▼

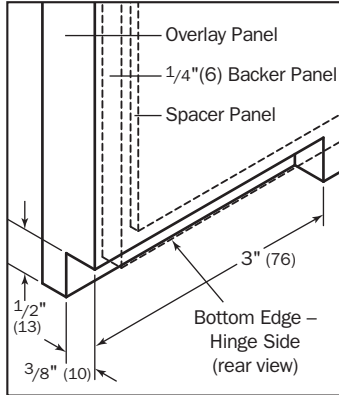

► Recessed area for hinge plate

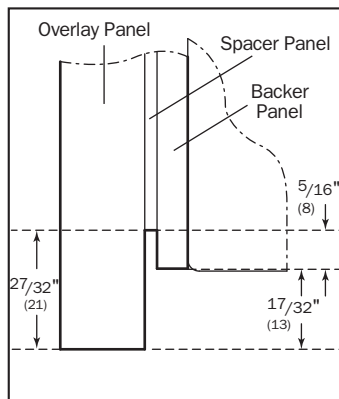

► Reveal area for door panel

### OVERLAY PANELS

**IMPORTANT NOTE:** For overlay door panels, it is necessary to rout a space for the unit's lower hinge plate so that it does not strike the door panel. Refer to the top illustration on this page.

You will minimize the reveal between the bottom of the overlay door panel and the top of the overlay drawer panel. Refer to the bottom illustration on this page.

If you choose not to rout a space for the lower hinge plate, you can reduce the total height of the overlay panel (decorative panel only) by  $\frac{1}{2}$ " (13).

#### ⚠ CAUTION

Do not exceed the overlay panel dimensions listed. If you try to make the reveal tighter between the door and drawer panels, the panels may hit when opening and closing, causing possible damage to the panels and the Sub-Zero unit.

**Model 611**  
**PANEL SPECIFICATIONS**



BUILT-IN

**SIDE PANELS** ▼

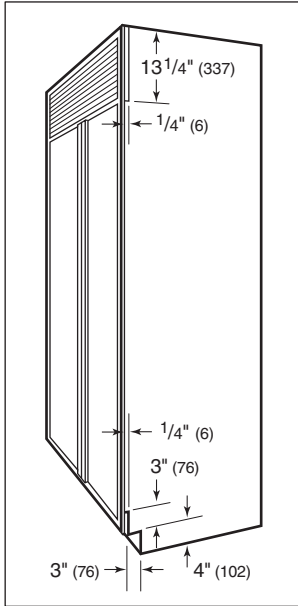

► *Cut-outs for grille and kickplate area*

**SIDE PANELS**

Side panels can be used with the framed, overlay and stainless steel design applications. When planning for side panels with the installation of the Built-In unit, you need to be aware of space configuration to achieve a pleasing fit. Depending on the exact panel you are using with your unit, the height of the panel will vary.

Cut-outs around the kickplate and grille area are required if a 1/4" (6) thick panel will be inserted into the main frame channel. The panel will need to be 24" (610) deep. Refer to the illustration on this page for placement of cut-outs. If a 3/8" (10) thick panel is used, the panel will abut the main frame and should be 23 7/8" (606) deep. The toe kick area may or may not be cut out depending on the look you want to achieve.

**HARDWARE CONSIDERATIONS**

Overlay models come without handle hardware. The beauty of this design is that you can match the surrounding cabinet hardware. You or the cabinet manufacturer must provide handle hardware to match the overall decorating scheme.

The handle hardware must be installed before installing the panel assembly. Use larger D-style handles. If screws with thick heads are used, the screws will need to be countersunk into the door before the panel is put into place. Refer to the full-scale illustrations at the end of this section for handle hardware considerations.

**IMPORTANT NOTE:** Sub-Zero does not recommend using single pull knobs on any of its Built-In units.

Optional stainless steel handles are available in a variety of diameters and lengths, as well as handles to match the color and style of Wolf ovens. Contact your Sub-Zero dealer for specifics. To obtain local dealer information, visit the Locator section of our website, [subzero.com](http://subzero.com).

**Model 611**  
**FULL-SCALE TEMPLATE**

**HANDLE PROFILE - FRAMED APPLICATION**

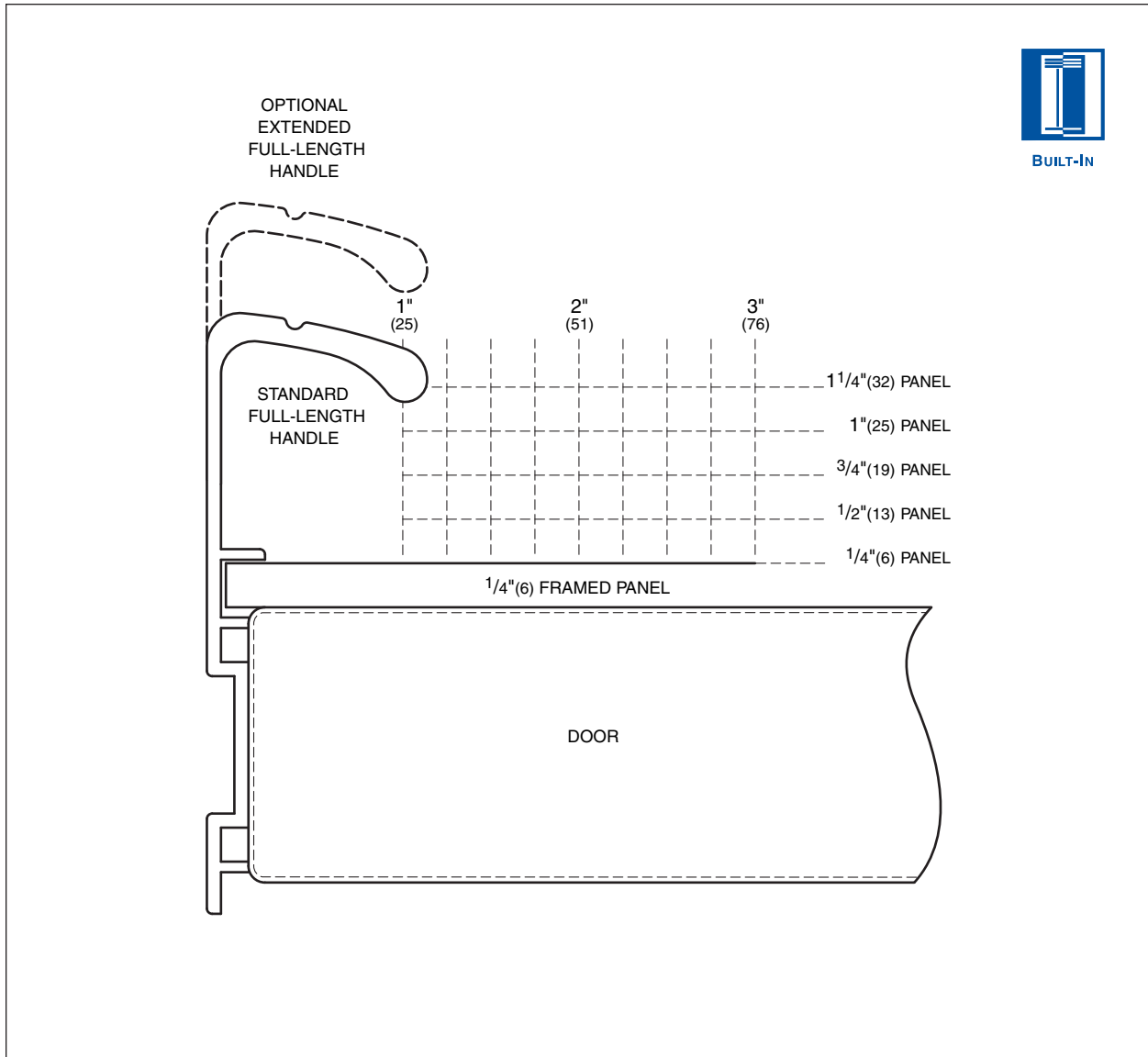

**BUILT-IN**

**FULL-SCALE TEMPLATES**

The following full-scale illustrations enable you to understand some of the unique situations you may face as you design the Built-In units into homes. These templates can be easily photocopied or used in your tracings.

**HANDLE PROFILE**

The full-scale illustration above shows handle placement for the framed application standard full-length handle and the optional extended full-length handle shown in the dashed line.

*Dimensions in parentheses are in millimeters unless otherwise specified.*

**Model 611**  
**FULL-SCALE TEMPLATE**

**HANDLE PROFILE - STAINLESS STEEL / OVERLAY APPLICATIONS**

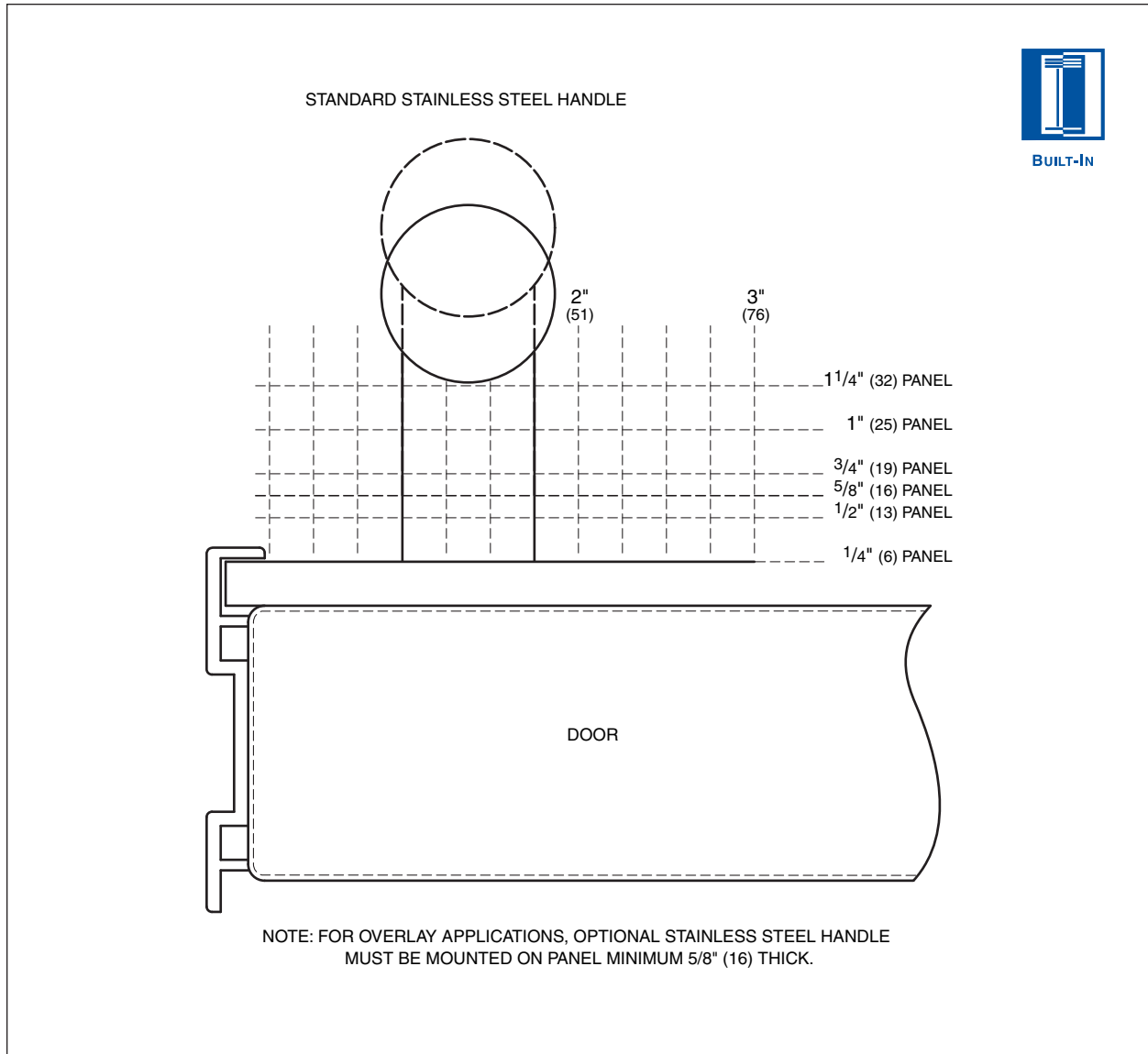

**PANEL AND HANDLE PROFILE**

The full-scale illustration above shows handle placement for the standard stainless steel handle on the wrapped stainless steel door and on overlay panel applications shown in the dashed line.

**IMPORTANT NOTE:** For overlay applications, the optional stainless steel handle must be mounted on a panel at least 5/8" (16) thick.

**Model 611**  
**FULL-SCALE TEMPLATE**

**PANEL AND HANDLE PROFILE - 130° DOOR OPENING**

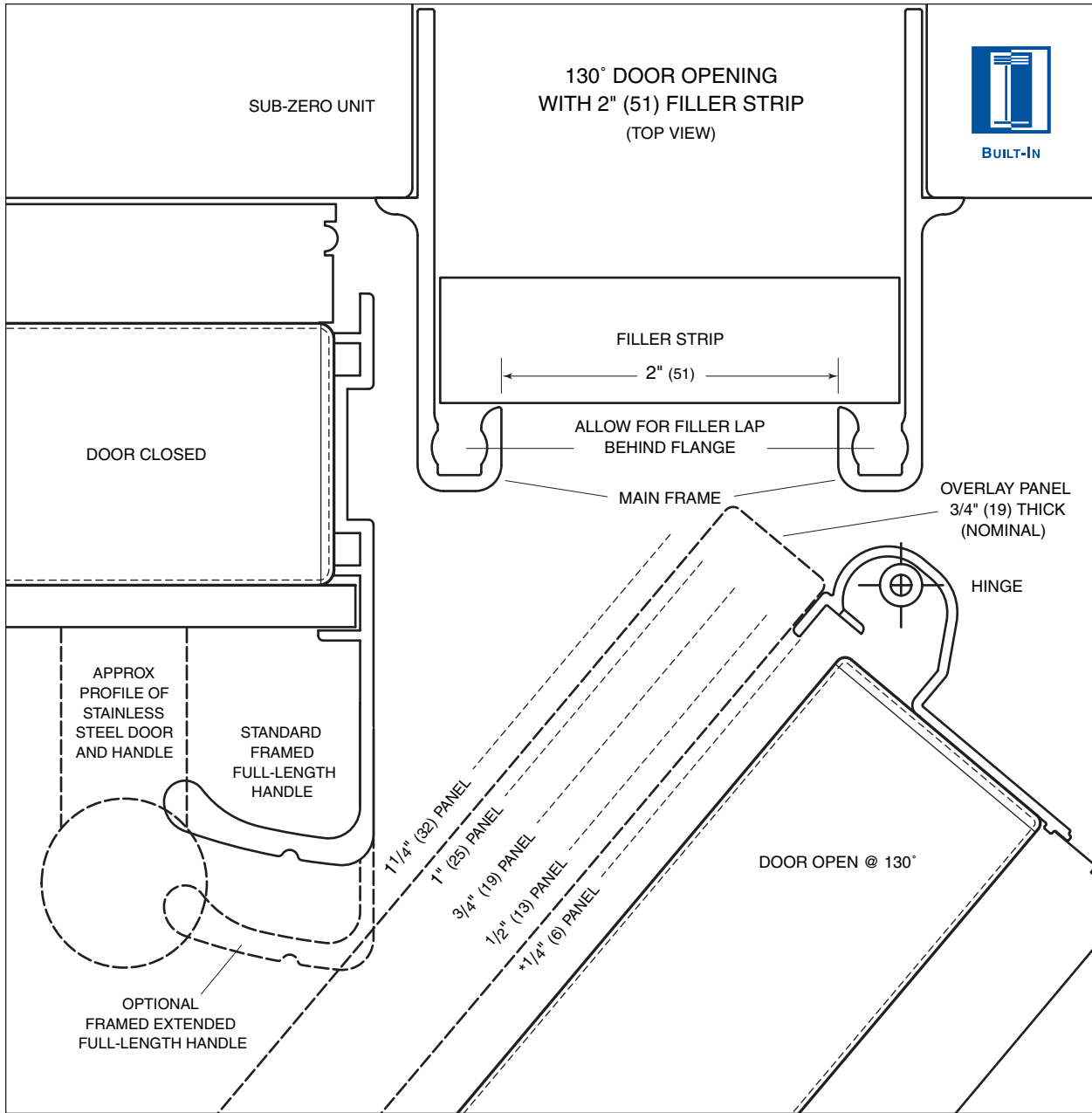

The full-scale illustration above shows the panel and handle profile of a 130° door opening with 2" (51) filler strip for framed applications.

Interference of door panels with handles at maximum door swing may require the use of an optional 90° door stop available through your Sub-Zero dealer.

*\*Approximate thickness of wrapped stainless steel door.*

*Dimensions in parentheses are in millimeters unless otherwise specified.*

To obtain local dealer information, visit the Locator section of our website, [subzero.com](http://subzero.com).

The full-scale illustration on the following page lets you see what considerations you need to make for any overlay panel applications, and how they may interact with adjacent cabinets and/or countertops.

**Model 611**  
**FULL-SCALE TEMPLATE**

**OVERLAY PANEL APPLICATION - 90° DOOR OPENING**

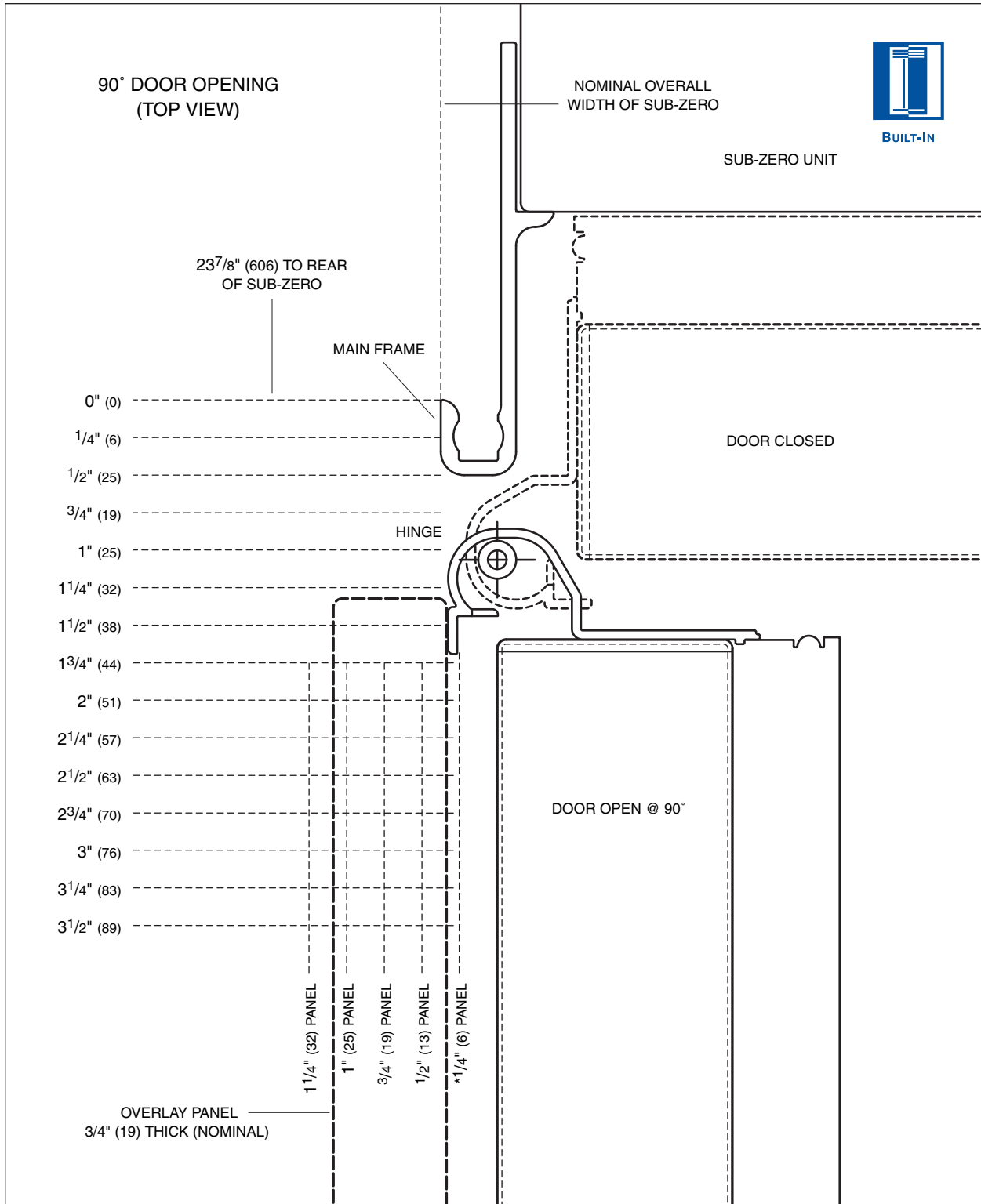

*\*Approximate thickness of wrapped stainless steel door.*

*Dimensions in parentheses are in millimeters unless otherwise specified.*