

SMH8165

# Microwave Oven

## user manual

imagine the possibilities

Thank you for purchasing this Samsung product. Please register your product at [www.samsung.com/global/register](http://www.samsung.com/global/register)

**SAMSUNG**

# features of your new microwave oven

---

- **Luxurious Look**

The Stainless Steel (STSS) exterior delivers a luxurious look to your kitchen. The design matches perfectly with your other kitchen appliances, providing a harmonious kitchen interior.

- **Controllable Ventilation System**

Depending on the duct location, you can set the orientation of the vent. You can also select the ventilation power (High, Low, Off) depending on your cooking selection.

- **One Touch Instant Cooking**

One touch Cooking saves you time and allows you to cook easily, simply by using various instant cooking options consisting of frequently used choices. Moreover, your Over The Range (OTR) oven provides optimal cook settings for various items guaranteeing satisfaction.

- **Cook-top Lighting**

Illuminate your cooking experience with Cook-top Lighting and oven control the degree of lighting (High/Low/Off)

- **Sensor Cooking**

Don't know how to cook? Samsung's new OTR sensor technology offers preset functions resulting in perfectly cooked dishes every time. Simply select a cooking menu, and the cooking results will astound you.

- **VFD display**

With an informative VFD (Vacuum Fluorescent Display), your OTR lets you easily use all available functions.











# important safety instruction

Throughout this manual, you'll see Warning and Caution notes.

These warnings, cautions, and the important safety instructions that follow do not cover all possible conditions and situations that may occur.

It's your responsibility to use common sense, caution, and care when installing, maintaining, and operation your microwave oven. Samsung is not liable for damages resulting from improper use.

## WHAT THE ICONS AND SIGNS IN THIS MANUAL MEAN:

 WARNING	<b>WARNING:</b> Hazards or unsafe practices that may result in severe personal injury or death.
 CAUTION	<b>CAUTION:</b> Hazards or unsafe practices that may result in minor personal injury or property damage.
	Do not attempt or use.
	Do not repair.
	Do not touch.
	Be careful
	Follow directions explicitly.
	Unplug the power plug from the wall socket.
	Make sure the machine is grounded to prevent electric shock.
	Call the service center for help.
	Note

## PRECAUTIONS TO AVOID POSSIBLE EXPOSURE TO EXCESSIVE MICROWAVE ENERGY:

-  Do not attempt to operate this microwave oven with the door open since open-door operation can result in harmful exposure to microwave energy. It is important not to defeat or tamper with the safety interlocks.

Do not place any object between the microwave oven front face and the door or allow soil or cleaner residue to accumulate on sealing surfaces.

**SAVE THESE INSTRUCTIONS**

# important safety instruction

---

Do not operate the microwave oven if it is damaged. It is particularly important that the microwave oven door close properly and that there is no damage to the

- Door (bent or dented),
- Hinges and latches (broken or loosened),
- Door seals and sealing surfaces.

 The microwave oven should not be adjusted or repaired by anyone except properly qualified service personnel.

## IMPORTANT SAFETY INSTRUCTIONS

---

When using any electrical appliance, basic safety precautions should be followed, including the following:



### WARNING

 Always observe Safety Precautions when using your oven. Never try to repair the oven on your own - there is dangerous voltage inside. If the oven needs to be repaired, call 1-800-SAMSUNG (7267864) for the name of an authorized service center near you.

## TO REDUCE RISK OF BURNS, ELECTRIC SHOCK, FIRE, PERSONAL INJURY OR EXPOSURE TO EXCESSIVE MICROWAVE ENERGY:

---

 Read all safety instructions before using the appliance.

Read and follow the specific “PRECAUTIONS TO AVOID EXPOSURE TO EXCESSIVE MICROWAVE ENERGY” on page 3.

This appliance must be grounded. Connect only to properly grounded outlets. See “IMPORTANT GROUNDING INSTRUCTIONS” on page 7 of this manual.

Install or place this appliance only in accordance with the installation instructions provided.

Use this appliance only for its intended use as described in the manual. Do not use corrosive chemicals or vapors in this appliance. This type of oven is specifically designed to heat, cook, or dry food. It is not designed for industrial or laboratory use.

As with any appliance, close supervision is necessary when used by children.

Keep the inside of the oven clean. Food particles or spattered oils stuck to the oven walls or floor can cause paint damage and reduce the efficiency of the oven.

Keep the power cord away from heated surfaces.

## SAVE THESE INSTRUCTIONS

When cleaning the door and oven surfaces, use only mild, nonabrasive soaps or detergents applied with a sponge or soft cloth.

Remove lids from baby food before heating. After heating baby food, stir well and test temperature by tasting before serving.

This over-the-range oven was designed for use over ranges no wider than 36 inches. It may be installed over both gas and electric cooking equipment.

-  Liquids, such as water, coffee, or tea are able to be overheated beyond the boiling point without appearing to be boiling. Visible bubbling or boiling when the container is removed from the microwave oven is not always present. THIS COULD RESULT IN VERY HOT LIQUIDS SUDDENLY BOILING OVER WHEN THE CONTAINER IS DISTURBED BY A SPOON OR OTHER UTENSILS, INSERTED INTO THE LIQUID.

Carefully remove container coverings, directing steam away from your hands and face.

Some items, like whole eggs and food in sealed containers, may explode if heated in this oven.

-  Do not operate this appliance if it has a damaged power cord or plug, if it is not working properly, or if it has been damaged.

Do not cover or block any of the openings on this appliance.

Do not store this appliance outdoors. Do not use near water - for example, near a kitchen sink, in a wet basement, or near a swimming pool, etc.

Do not immerse the power cord or plug in water.

Do not let the power cord hang over edge of table or counter.

Do not try to preheat the microwave oven or operate it while empty.

Do not cook without the glass tray in place on the oven floor. Food will not cook properly without the tray in place.

Do not defrost frozen beverages in narrow-necked bottles. The containers can break.

Dishes and containers may become hot. Handle with care.

Do not mount over a sink.

Do not store anything directly on top of the appliance when it is in operation.

-  This appliance should be serviced only by qualified service personnel. Contact the nearest authorized service facility for examination, repair, or adjustment.

## SAVE THESE INSTRUCTIONS

# important safety instruction

---

## **TO REDUCE THE RISK OF FIRE IN THE OVEN:**

---

- Remove wire twist-ties from plastic cooking bags before placing bags in oven.
- Do not use the oven compartment for storage purposes. Do not leave paper products, cooking utensils, or food in the oven when not in use.  
  
Do not overcook food. Watch appliance carefully if paper, plastic, or other combustible materials are inside.
- If materials inside the oven ignite, keep the oven door closed, turn the oven off, disconnect the power cord, or shut off the power at the fuse or circuit breaker panel. If the door is opened, the fire may spread.

## **TO REDUCE THE RISK OF INJURY TO PERSONS:**

---

- Stir the liquid both before and halfway through heating it.  
  
After heating, allow the container to stand in the microwave oven for a short time before removing the container.
- Do not use straight-sided containers with narrow necks.  
  
Do not overheat liquids.
- Use extreme care when inserting a spoon or other utensils into the container.

**SAVE THESE INSTRUCTIONS**



# IMPORTANT GROUNDING INSTRUCTIONS

---

-  This appliance must be grounded. In the event of an electrical short circuit, grounding reduces the risk of electric shock by providing an escape wire for the electrical current. This appliance is equipped with a power cord that includes a grounding wire and a grounding plug. The plug must be plugged into an outlet that is properly installed and grounded. Plug the three-prong power cord into a properly grounded outlet of standard 115-120 voltage, 60 Hz. Your oven should be the only appliance on this circuit.

## **WARNING**

---

-  **CAUTION** Improper use of the grounding plug can result in a risk of electric shock. Consult a qualified electrician or servicer if you do not understand the grounding instructions or if you are not sure if the appliance is properly grounded.
-  Do not use an extension cord with this appliance. If the power cord is too short, have a qualified electrician or service technician install an outlet near the appliance.  
  
Do not cut or remove the third (ground) prong from the power cord under any circumstances.
-  Connect the oven only to a 15A dedicated circuit.

## THE VENT FAN



---

-  The fan will operate automatically under certain conditions. Take care to prevent the starting and spreading of accidental cooking fires while the vent fan is in use.

In the event of a grease fire on the surface units below the microwave oven, smother a flaming pan on the surface unit by covering the pan completely with a lid, a cookie sheet or a flat tray.

Clean Ventilating Hoods Frequently - Grease should not be allowed to accumulate on the ventilating hood.

When flaming foods under the hood, turn the fan on.

-  Use care when cleaning the vent-hood filter. A corrosive cleaning agent, such as lye-based oven cleaner, may damage the filter.
-  Never leave surface units beneath your microwave oven unattended at high heat settings. Boilovers cause smoking and greasy spillovers that may ignite and spread if the microwave vent fan is operating. To minimize automatic fan operation, use adequate sized cookware and use high heat on surface units only when necessary.

**SAVE THESE INSTRUCTIONS**

# contents

---

## **SETTING UP YOUR NEW MICROWAVE OVEN**

10

- 10 Checking the parts
- 11 Warranty and service information
- 11 Setting up your microwave oven
- 12 Checking the control panel
- 14 Setting the time

## **USING YOUR MICROWAVE OVEN**

15

- 15 Using the Kitchen Timer Button
- 15 Using the One Minute+ Button
- 15 Using the More/Less Buttons
- 15 Using the Vent Hi/Lo/Off Button
- 15 Using the Light Hi/Lo/Off Button
- 16 Using the Turntable On/Off button
- 16 Using the metal shelf
- 17 Using the Sensor Cook buttons
- 18 Using the Auto Defrost button
- 20 Using the Sensor Reheat button
- 21 Using the Custom Cook button
- 21 Using the Handy Helper button
- 22 Using the Kids Meals button
- 23 Using the Snack Bar button
- 24 Microwave cooking times & Power levels

## **COOKWARE GUIDE**

26

- 26 Microwave-safe Utensils

## **COOKING GUIDE**

28

- 28 Microwaves



**CLEANING AND MAINTAINING YOUR  
MICROWAVE OVEN**

31

- 31** Cleaning the exterior
- 31** Cleaning the interior
- 31** Cleaning the door and door seals
- 31** Cleaning the turntable and roller rings
- 32** Cleaning the grease filter
- 32** Storing and repairing your microwave oven
- 33** Replacing the Cooktop/Night light
- 33** Replacing the oven light
- 34** Replacing the charcoal filter

**TROUBLESHOOTING**

35

- 35** Check these points if your microwave oven...

**APPENDIX**

36

- 36** Specifications

**WARRANTY**

37

# setting up your new microwave oven

---

Be sure to follow these instructions closely so that your new microwave oven works properly.

## CHECKING THE PARTS

---

Carefully unpack your microwave oven, and make sure you've received all the parts shown below. If your microwave oven was damaged during shipping, or if you do not have all the parts, contact Samsung Customer Service. (Refer to the "WARRANTY AND SERVICE INFORMATION" on page 11.)

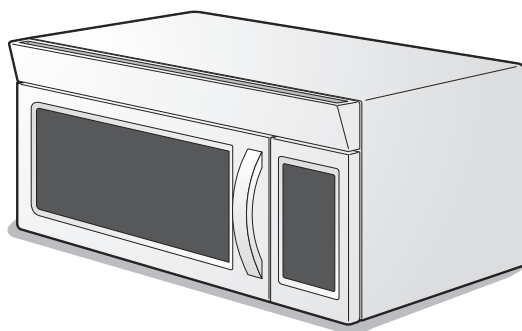

**Microwave oven**

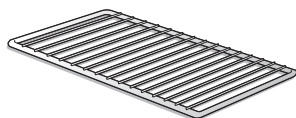

**Shelf**  
DE75-00032A

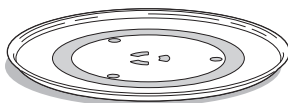

**Glass tray**  
DE74-20016A



**Roller guide ring**  
DE92-90495A

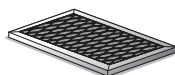

**Charcoal filter**  
DE63-00367A

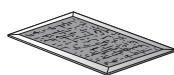

**Grease filter**  
DE63-00196B



**Hardware-kit**  
DE68-90505E

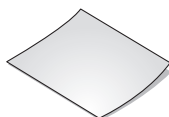

**Registration Card**  
6801-001581



**Manual**  
(User DE68-00355D &  
Installations DE68-00357R)

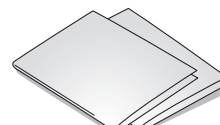

**Templates**  
(Top DE68-01682C &  
Wall DE68-02230Q)

## WARRANTY AND SERVICE INFORMATION

To help us to serve you better, please complete the enclosed registration card and promptly return it by mail. If the registration card is missing, you can call Samsung Electronics, Inc., at **1-800-SAMSUNG (726-7864)** or register online at **www.samsung.com/global/register**. When contacting Samsung, please provide the specific model and serial number information which is usually located on the back or bottom of the product. Please record these numbers below, along with the other requested information. Keep this information in a safe place as a permanent record of your purchase to aid in identification in case of theft or loss, and a copy of your sales receipt as a proof of purchase if warranty service is needed.

**MODEL NUMBER** \_\_\_\_\_

**SERIAL NUMBER** \_\_\_\_\_

**DATE PURCHASED** \_\_\_\_\_

**PURCHASED FROM** \_\_\_\_\_

Warranty service can only be performed by a Samsung Authorized Service Center. If you should require warranty service, provide the above information with a copy of your sales receipt to the Samsung Authorized Service Center.

For service assistance and the location of the nearest service center, please call **1-800-SAMSUNG (7267864)**.

## SETTING UP YOUR MICROWAVE OVEN

1. Open the door by pulling the handle on the right side of the door.
2. Wipe the inside of the oven with a damp cloth.

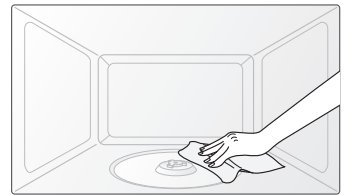

3. Install the pre-assembled ring into the indentation at the center of the microwave oven.

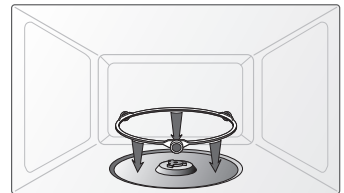

4. Place the glass tray securely in the center of the pre-assembled roller ring.

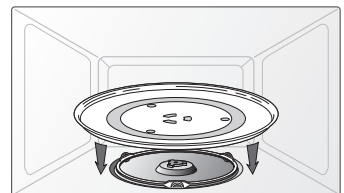

# setting up your new microwave oven

## CHECKING THE CONTROL PANEL

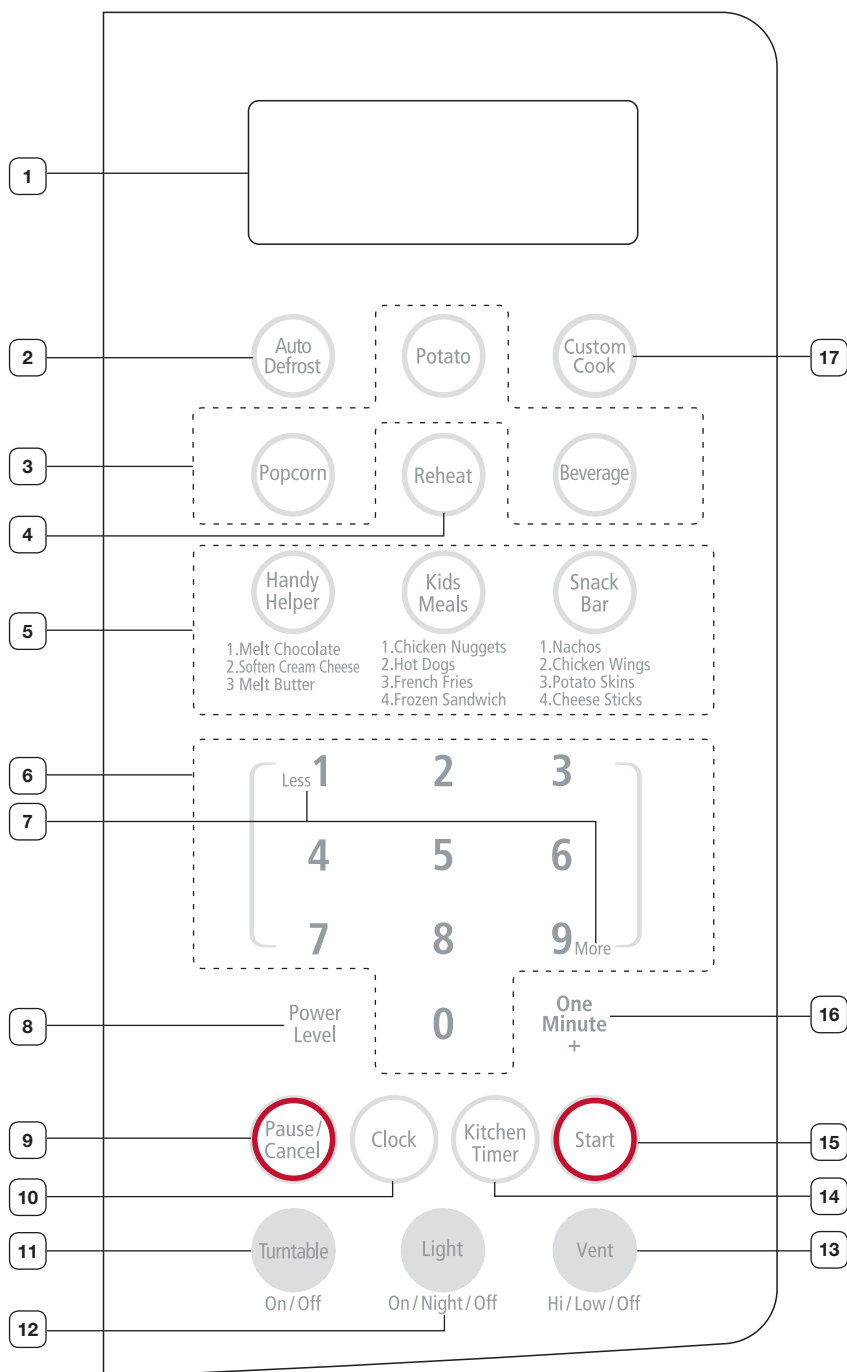

1	<b>DISPLAY</b>	The display displays the time when the microwave is not being used, as well as your selected cooking time settings and cooking functions.
2	<b>AUTO DEFROST BUTTON</b>	Use this button to defrost food according to its weight.
3	<b>SENSOR COOK BUTTON</b>	Use these buttons to select a preset cooking cycle.
4	<b>SENSOR REHEAT BUTTON</b>	Use this button to reheat dinner plates, casseroles, and pasta.
5	<b>HANDY HELPER, KIDS MEALS, SNACK BAR BUTTONS</b>	Press these buttons to cook specific foods. The items are listed under the buttons.
6	<b>NUMBER BUTTONS</b>	Use the number buttons to enter the cooking time, power level, quantity, or weight.
7	<b>MORE/LESS BUTTONS</b>	The <b>More/Less</b> buttons allow you to adjust the pre-set cooking times once you have started cooking.
8	<b>POWER LEVEL BUTTON</b>	Press this button to select a cooking power level.
9	<b>PAUSE/CANCEL BUTTON</b>	Use this button to stop/pause the oven or to clear all entries.
10	<b>CLOCK BUTTON</b>	Use this button to enter the time.
11	<b>TURNTABLE ON/OFF BUTTON</b>	Use this button to turn the turntable on or off.
12	<b>LIGHT BUTTON</b>	The <b>Light</b> button allows you to select a light setting for your microwave.
13	<b>VENT BUTTON</b>	The vent removes steam and other vapors from the cooking surface.
14	<b>KITCHEN TIMER BUTTON</b>	This microwave allows you to use your microwave oven as a timer. Use the Kitchen Timer button for timing up to 99 minutes 99 seconds.
15	<b>START BUTTON</b>	Press this button to start a selected function. If you open the door after the oven begins to cook, close the door and press the <b>Start</b> button again.
16	<b>ONE MINUTE+ BUTTON</b>	This simplified control saves you time, letting you quickly start cooking at 100% power without the need to press the <b>Start</b> button.
17	<b>CUSTOM COOK BUTTON</b>	Press this button to store cooking instructions or recall them later from memory.

 Refer to “Using your microwave oven” below for detailed information on the buttons described in the table above.

# setting up your new microwave oven

---

## SETTING THE TIME

---

Your microwave oven is equipped with a built-in clock. Set the clock when first installing your microwave oven and after a power failure. The time is displayed whenever the microwave oven is not being used.

1. Press the **Clock** button.
2. Select AM/PM by press **Clock** button.
3. Enter time.
4. Press **Clock** button.

# using your microwave oven

---

Cooking has never been easier than with your new Samsung microwave oven. The following section describes everything you need to know about using your microwave oven.

## USING THE KITCHEN TIMER BUTTON

---

This microwave allows you to use your microwave oven as a timer. Use the Kitchen Timer for timing up to 99 minutes, 99 seconds.

1. Enter the time by using the number buttons.
  2. Press the **Kitchen Timer** button.
- When the time is over, four beeps will sound and *End* is displayed.

## USING THE ONE MINUTE+ BUTTON

---

This simplified control saves you time, letting you quickly start cooking at 100% power without the need to press the **START** button.

1. Press the **One Minute+** button for each minute you wish the food to be cooked for. For example, press it twice to cook it for two minutes. The time is displayed and the oven starts automatically.
2. Add minutes to a cooking program already in progress by pressing the **One Minute+** button for every additional minute you wish to add.

## USING THE MORE/LESS BUTTONS

---

The **More (9)/Less (1)** buttons allow you to adjust the pre-set cook times. They only work for the "Reheat", "Auto Cooking", "One Minute+", and "Time Cook" modes. Use the **More (9)/Less (1)** buttons only after you have already begun cooking using one of these modes.

1. Use the **More (9)** button to add time to an automatic cooking procedure.
2. Use the **Less (1)** button to decrease the time of an automatic cooking procedure.
  - Each time you press the More (9) button while cooking manually, the current cooking time increases by 10 seconds. Press the Less (1) button to decrease it by 10 seconds.
  - Function is disabled for "Auto Defrost" & "Beverage" option.

## USING THE VENT HI/LO/OFF BUTTON

---

The vent removes steam and other vapors from the cooking surface. You can manually select the vent setting.

1. Press the **Vent Hi/Lo/Off** button once for a high fan speed.
2. Press the **Vent Hi/Lo/Off** button twice for a low fan speed.
3. Press the **Vent Hi/Lo/Off** button three times to turn the fan off.

If the temperature becomes too hot around the microwave oven, the fan in the vent hood will automatically turn on at the low setting to cool the oven. The fan will automatically turn off when the oven has cooled down sufficiently. This is an automated process and cannot be turned off.

## USING THE LIGHT ON/NIGHT/OFF BUTTON

---

The **Light Hi/Lo/Off** button allows you to select a light setting for your microwave.

1. Press the **Light On/Night/Off** button once for the bright light setting.
2. Press the **Light On/Night/Off** button twice for the night light
3. Press the **Light On/Night/Off** button three times to turn the light completely off.

# using your microwave oven

## USING THE TURNTABLE ON/OFF BUTTON

For best cooking results leave the turntable on. However, for large dishes it can be turned off. Press the TURNTABLE ON/OFF button to turn the turntable on or off.

 The turntable may become too hot to touch. Use pot holders to touch the turntable during and after cooking.

## USING THE METAL SHELF

Use the metal shelf to cook more than one item at the same time.

-  CAUTION
- Do not use a microwave browning dish on the shelf. The shelf could overheat.
  - Do not use the oven with the shelf on the microwave floor. This could damage the microwave.
  - Use pot holders when handling the shelf as it may be hot.
  - Do not use the metal shelf when cooking popcorn.

Food cooks best on the turntable.

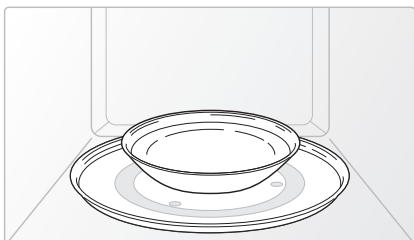

**For best results**

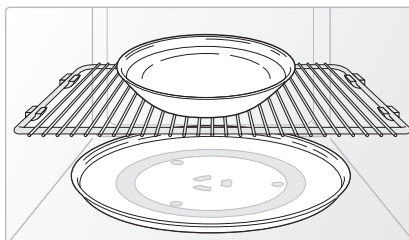

**Uneven results**

The shelf gives you the option to reheat more than one dish at the same time.

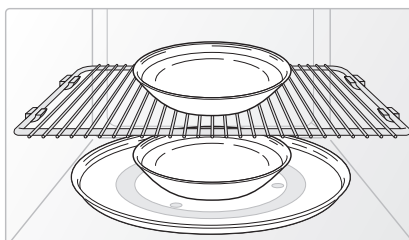
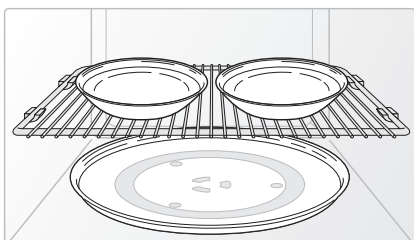

## Reheating food

To reheat food on 2 levels or to reheat food on the lower level:

- Multiply the reheating time by 1½.
- Switch places halfway through the reheating process.

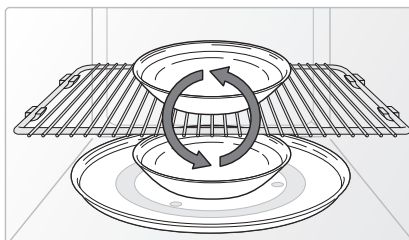
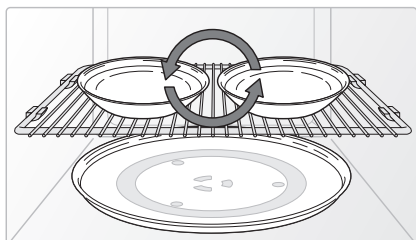



## USING THE SENSOR COOK BUTTONS

The **Sensor Cook** buttons consist of frequently used settings allowing you to select them quickly and conveniently. Use the **More (9)/Less (1)** buttons to set your temperature preference. If the food is not thoroughly cooked or reheated when using the auto cook feature, complete the cooking process by selecting a power level and cooking time.



Do not continuously use the **Sensor Cook** buttons. The oven must cool for 5 minutes between uses or the food will overcook.

### Sensor cooking utensils & covers

To obtain good cooking results using these functions, follow the directions for selecting the appropriate containers and covers in the Cookware section on p26.

Always use microwave-safe containers and cover with a lid or plastic wrap. When using plastic wrap, turn back one corner to allow steam to escape.



CAUTION

Always use the proper lid for the container. If the utensil does not have its own lid, use plastic wrap.



CAUTION

Fill containers at least half full.



Foods that require stirring or rotating should be stirred or turned at the end of the Sensor Cook cycle, when the time has started to count down on the display.



Do not use the Auto Sensor cooking feature continuously. Wait 5 minutes before selecting another sensor cooking operation.



To avoid poor results, do not use the Auto Sensor when the room ambient temperature is too high or too low.

### Sensor cooking table

FOOD	AMOUNT	PROCEDURE
Popcorn	3.0 - 3.5 oz 1 package	Use only one microwave popcorn bag at a time. Be careful when removing and opening the heated bag from the oven. Let the oven cool for at least 5 minutes before using it again.
Potatoes	1 to 6 potatoes.	Pierce each potato several times with a fork. Place on the turntable in a spoke-like fashion. After cooking, let the potatoes stand for 3-5 minutes. Let the oven cool for at least 5 minutes before using it again.
Beverage	8 oz.	Use a measuring cup or mug and do not cover. Place the beverage in the oven. After heating, stir well. Let the oven cool for at least 5 minutes before using it again.

The correct food temperature varies from person to person. Use the **More (9)/Less (1)** buttons to select your personal temperature preference.

# using your microwave oven

---

## USING THE AUTO DEFROST BUTTON

---

The defrost choices are preset in the oven. The defrost cycle provides you with the best defrosting method for frozen foods, because the oven automatically sets the defrosting times according to the entered weight. For added convenience, the auto defrost function beeps to remind you to check or turn over the food during the defrost cycle.

Press the **Auto Defrost** button once and select the food weight. The available weight ranges from 0.1 to 6.0 lbs.

1. Press the **Auto Defrost** button.
2. Use the number buttons to enter the weight or press the **Auto Defrost** button to select weight.
3. Unit automatic on.



After the **start**, the display counts down the defrosting time. The oven will beep twice during the defrost cycle. At this time, open the door and turn the food as needed. Remove any thawed portions, then return the frozen portions to the oven and press the **START** button to resume the defrost cycle.

The defrost cycle continues while the oven is beeping and only stops when the door is opened.

## Defrosting tips

---

When using auto defrost, the entered weight is the net weight in pounds and tenths of pounds (the weight of the food minus the container).

Use the auto defrost cycle for raw food only. The auto defrost cycle gives best results when the food to be thawed is a minimum of 0°F (taken directly from a true freezer). If food has been stored in a refrigerator-freezer that does not maintain a temperature of 5°F or below, always program a lower food weight (for a shorter defrosting time) to prevent actually cooking the food.

If the food is stored outside the freezer for up to 20 minutes, enter a lower food weight.

The shape of the package alters the defrosting time. Shallow rectangular packets defrost more quickly than a thick block.

Separate the pieces as they begin to defrost. Separated pieces defrost more easily.

Shield areas of food with small pieces of foil if they start to become warm.

You can use small pieces of aluminum foil to shield foods such as chicken wings, leg tips, and fish tails, but the foil must not touch the sides of the oven as foil causes arcing, which can damage the oven lining.

## Auto defrosting table

Follow the instructions below when defrosting different types of food.

FOOD	AMOUNT	PROCEDURE
<b>Roast Beef, Pork</b>	2.5-6.0 lbs.	Start with the food placed fat side down. After each stage, turn the food over and shield any warm portions with narrow strips of aluminum foil. Let stand, covered for 10-20 minutes.
<b>Steaks, Chops, Fish</b>	0.5-3.0 lbs.	After each stage, rearrange the food. If there are any warm or thawed portions of food, shield them with narrow, flat pieces of aluminum foil. Remove any pieces of food that are nearly defrosted. Let stand, covered for 5-10 minutes.
<b>Ground Meat</b>	0.5-3.0 lbs.	After each stage, remove any pieces of food that are nearly defrosted. Let stand, covered with foil for 5-10 minutes.
<b>Whole Chicken</b>	2.5-6.0 lbs.	Remove giblets before freezing poultry. Start defrosting with the breast side down. After the first stage, turn the chicken over and shield any warm portions with narrow strips of aluminum foil. After the second stage, again shield any warm portions with narrow strips of aluminum foil. Let stand, covered for 30-60 minutes in the refrigerator.
<b>Chicken Pieces</b>	0.5-3.0 lbs.	After each stage, rearrange or remove any pieces of food that are nearly defrosted. Let stand for 10-20 minutes.
<b>Bread</b>	0.1-2.0 lbs.	Arrange the rolls in a circle on kitchen paper in the middle of the turntable Turn over halfway through the defrosting time.

-  Check the food when you hear the oven signal. After the final stage, small sections may still be icy; let them stand to continue the thawing process. Do not defrost until all ice crystals have thawed. Shielding roasts and pieces of steak using small pieces of foil prevents the edges from being cooked before the center of the food has defrosted. Use narrow, flat, smooth strips of aluminum foil to cover edges and thinner sections of the food.

# using your microwave oven

## USING THE SENSOR REHEAT BUTTON

Heating leftovers and precooked foods is easy with your new microwave. By actually sensing the humidity that escapes as the food is heated, the oven's heating time is automatically adjusted depending on the type and amount of precooked food.

 All food must already be precooked. Plates of food and casseroles should be stored at refrigerator temperature.

Press the **Sensor Reheat** button to begin reheating your precooked food. The display will show *REHEAT* and the oven will start automatically. Use the **More (9)/Less (1)** buttons to adjust the heating time. If you want to check the current time appear in VFD while reheating, press the **Clock** button.

### Sensor reheating table

Follow the instructions below when reheating different types of food.

FOOD	AMOUNT	PROCEDURE
Plates of food	1 serving (1 plate)	Use only precooked, refrigerated foods. Cover the plate with vented plastic wrap or waxed paper tucked under the plate. If the food is not as hot as you would like after using the Sensor Reheat function, continue heating using additional time and power.  <b>Contents:</b> 3-4 oz. meat, poultry or fish (up to 6 oz. with bone) ½ cup starch (potatoes, pasta, rice, etc.) ½ cup vegetables (about 3 - 4 oz.)
Casserole Reheating pasta	1 to 4 servings	Cover the plate with a lid or vented plastic wrap. If the food is not as hot as you would like after using the "Sensor Reheat" function, continue heating using additional time and power. Stir the food once before serving.  <b>Contents:</b> Casserole, refrigerated foods. Pasta: canned spaghetti and ravioli

## USING THE CUSTOM COOK BUTTON

The custom cook button lets you store cooking instructions, and recall them later from memory and begin cooking quickly.

### Storing/Memorizing a recipe

1. Press the **Custom Cook** button. (Touch the pad twice to delete the previous Custom setting.)
2. Enter the cook time.
3. Press the **Power Level** button.
4. Enter the power level.
5. Press the **Custom Cook** button.

### Recalling a stored recipe

1. Press the **Custom Cook** button.
2. Press the **START** button.
3. When the cook time is over, four beeps will sound and *End* is displayed.
  - You can only recall one stored recipe at a time.

## USING THE HANDY HELPER BUTTON

1. Press the **Handy Helper** button. The display will show: *MELT CHOCOLATE 1 CUP CHIPS*. (Refer to the Handy helper table). Press the button repeatedly to cycle through the available items.
2. Press the number **1** or **2** buttons to select the serving size. Only number **1** (serving) is available for the Melt Chocolate and Soften Cream Cheese options. (Refer to the Handy helper table for the serving size).
3. Press the **Start** button to begin cooking.

### Handy helper table





ITEM	AMOUNT	REMARKS
<b>Melt chocolate</b>	1 cup chips or 1 square	Place the chocolate chips or squares in a microwave-safe container. When the oven beeps, stir the chocolate and restart the oven. Stir and let stand for 1 minute.
<b>Soften cream cheese</b>	8-oz package	Unwrap the cream cheese and place on a microwave-safe container. Cut in half vertically. Let stand for 2 minutes.
<b>Melt butter</b>	1 stick (serving) 2 sticks (serving)	Remove the wrapping and cut the butter in half vertically. Place the butter in a dish and cover with wax paper. Stir well after finishing and let stand for 1-2 minutes.

# using your microwave oven

## USING THE KIDS MEALS BUTTON

1. Press the **Kids Meals** button. The display will show *CHICKEN NUGGETS*. (Refer to the Kids meals table). Press the button repeatedly to cycle through the available items.
2. Press the number **1** or **2** buttons to select the serving size. (Refer to the Kids meals table for the serving size.)
3. Press the **Start** button to begin cooking.

### Kids meals table

ITEM	AMOUNT	REMARKS
Chicken nuggets (frozen)	1 serving 2 servings	Place a paper towel on a plate and arrange the nuggets in a spoke-like fashion on the paper towel. Do not cover. Let stand for 1 minute after heating.  Refer to the package directions for the serving size and the amount of food. Use the More button to add additional cooking time if the chicken nuggets are not hot enough.
Hot dogs	2 hot dogs 4 hot dogs	Pierce the hot dogs and place them on a plate. When the oven beeps, add the buns and restart the oven. Let stand for 1 minute after heating.  For the best texture, the buns should be added to the hot dogs when the oven beeps.
French fries (frozen)	1 serving 2 servings	Place two paper towels on a microwave-safe plate and arrange the french fries on the towels without letting them overlap. Blot the fries with additional paper towels after removing from the oven. Let stand for 1 minute.  refer to the directions on the packaging for the serving size and the amount of food.
Frozen sandwiches (in crisping sleeve) 9-oz package size	1 sandwich 2 sandwiches	Place the frozen sandwich in a susceptor “crisping sleeve” (which is in a package) and place on a microwave-safe plate. Remove from the “crisping sleeve”. Let stand for 2 minutes after heating.  For large sandwiches, use the <b>More (9)</b> button to increase the heating time.

## USING THE SNACK BAR BUTTON

1. Press the **Snack Bar** button. The display will show *NACHOS 1 SERVING*. (Refer to the snack bar table). Press the button repeatedly to cycle through the available items.
2. Press the number **1** or **2** buttons to select the serving size. Only number **1** (serving) is available for Nachos. (Refer to the snack bar table for the serving size).
3. Press the **Start** button to begin cooking.

### Snack bar table

ITEM	AMOUNT	REMARKS
Nachos	1 serving	Place the nachos on a plate without letting them overlap. Sprinkle cheese evenly over them. <b>Contents:</b> 2 cups tortilla chips 1/3 cup grated cheese
Chicken wings	5-6 oz. 7-8 oz.	Use precooked, refrigerated chicken wings. Place the chicken wings around the plate in a spoke-like fashion and cover with wax paper. Let stand for 1 to 2 minutes.
Potato skins	1 cooked potato 2 cooked potatoes	Cut the cooked potato into 4 even wedges. Scoop or cut out the potato flesh, leaving about a ¼ in. of skin. Place the skins in a spoke-like fashion around the plate. Sprinkle with bacon, onions and cheese. Do not cover. Let stand 1 to 2 minutes.
Cheese sticks (frozen)	5-7 pcs 8-10 pcs	Place the cheese sticks on a plate in a spoke-like fashion. Do not cover. Let stand for 1 to 2 minutes after heating.  The sizes of the cheese sticks may vary. For smaller size cheese nuggets, use the <b>Less (1)</b> button to decrease the heating time. For larger size cheese sticks, use the <b>More (9)</b> button to increase the heating time.

# using your microwave oven

---

## MICROWAVE COOKING TIMES & POWER LEVELS

---

Your oven allows you to set two different cooking stages, each with their own time length and power level. The power level lets you control the heating intensity from Warm (1) through to High (10).

### Cooking at high power levels

---

1. Use the number buttons to enter the cook time.
2. Press the **START** button.
3. When the cook time is over, four beeps will sound and *End* is displayed.

 If you do not enter a power level, the microwave oven cooks at the High Power Level by default.

### Cooking at lower power levels

---

Cooking at high power does not always give you the best results with foods that require slower cooking, such as roasts, baked goods, or custards. Your oven has 9 additional power settings in addition to high.

1. Use the number buttons to enter the cook time.
2. Press the **Power Level** button.
3. Use the number buttons to enter the power level.
4. Press the **START** button.
5. When the cook time is over, four beeps will sound and *End* is displayed.



## Cooking with more than one cook cycle

For best results, some recipes call for one Power Level for a certain length of time, and another Power Level for another length of time. Your oven can be set to change from one to another automatically, if the first cycle is the defrost cycle.

1. Use the number buttons to enter the cook time.
2. Press the **Power Level** button.
3. Use the number buttons to enter the power level.
4. Use the number buttons to enter the second cook time.
5. Press the **Power Level** button.
6. Use the number buttons to enter the power level.
7. Press the **START** button.
8. When the cook time is over, four beeps will sound and *End* is displayed.

## Power Levels

The 10 power levels allow you to choose the best power level for any food you may be cooking. The power levels are listed below with examples of foods and liquids best cooked at each level, and the amount of microwave power being used.

POWER LEVEL	MICROWAVE OUTPUT	USE
10 (High)	100 %	Boiling water. Cooking ground beef. Making candy. Cooking fresh fruit and vegetables. Cooking fish and poultry. Preheating browning dish. Reheating beverages. Bacon slices.
9	90 %	Reheating meat slices quickly. Sautéing onions, celery, and green pepper
8	80 %	Reheating all types of items(Dinner plate, pasta, meat, soup or sauce, etc.). Cooking scrambled eggs.
7	70 %	Cooking breads and cereal products. Cooking cheese dishes, veal. Cooking cakes, muffins, brownies, cupcakes.
6	60 %	Cooking pasta.
5	50 %	Cooking meats, whole poultry. Heating custard Cooking whole chickens, turkey, spare ribs, rib roasts, sirloin roasts.
4	40 %	Cooking less tender cuts of meat. Reheating frozen convenience foods.
3	30 %	Thawing meat, poultry, and seafood. Cooking small quantities of food. Finishing cooking casserole, stew, and some sauces.
2	20 %	Softening butter and cream cheese. Heating small amounts of food.
1	10 %	Softening ice cream. Raising yeast dough.

# cookware guide

To cook food in the microwave oven, the microwaves must be able to penetrate the food without being reflected or absorbed by the dish.

It is important to choose the correct cookware, therefore look for cookware that is marked microwave-safe.

The table below lists various types of cookware and indicates if and how they should be used in a microwave oven.

## MICROWAVE-SAFE UTENSILS

If you are not sure whether an item is microwave-safe or not, you can perform the following simple test:

1. Fill 1 cup of a glass measuring cup –with water and put it inside your oven next to the item to test.
2. Press the **One Minute+** button once to heat them both for one minute at high power. After the minute, the water should be warm and the item you are testing should be cool. If the dish is warm, then it is absorbing microwave energy and is not microwave-safe.

COOKWARE	MICROWAVE-SAFE	COMMENTS
Aluminum foil	✓ X	Can be used in small quantities to protect areas against overcooking. Arcing can occur if the foil is too close to the oven wall or if too much foil is used.
Browning plate	✓	Do not preheat for more than eight minutes.
Ceramic, porcelain, and stoneware	✓	Porcelain, pottery, glazed earthenware and bone china are usually suitable, unless decorated with a metal trim.
Disposable polyester cardboard	✓	Some frozen foods are packaged in these materials.
Fast-food packaging		
Polystyrene cups/containers	✓	Can be used to warm food. Overheating may cause the polystyrene to melt.
Paper bags or newspaper	X	May catch fire.
Recycled paper or metal trims Glassware	X	May cause arcing.
Glassware		
Oven-to-table ware	✓	Can be used, unless decorated with a metal trim.
Fine glassware	✓	Can be used to warm foods or liquids. Delicate glass may break or crack if heated suddenly.
Glass jars	✓	Regular glass is too thin to be used in a microwave, and can shatter.
Metal		
Dishes, Utensils	X	May cause arcing or fire.
Freezer bag twist ties	X	
Paper		

COOKWARE	MICROWAVE-SAFE	COMMENTS
Plates, cups, napkins and Kitchen paper	✓	For short cooking times and warming. Also to absorb excess moisture.
Recycled paper	✓	Do not use recycled paper towels, which may contain metal and may catch fire or cause arcing.
<b>Plastic</b>		
Containers	✓	Can be used if heat-resistant thermoplastic. Some plastics may warp or discolor at high temperatures. Do not use Melamine plastic.
Cling film	✓	Can be used to retain moisture. Avoid wrapping the food too tight. Take care when removing the film as hot steam will escape.
Freezer bags	✓ X	Only if boilable or oven-proof. Should not be airtight. Prick with a fork, if necessary.
<b>Wax or grease-proof paper</b>	✓	Can be used to retain moisture and prevent spattering.
<b>Thermometer</b>	✓	Use only those marked “Microwave-safe” and follow the directions. Check the temperature in several places. Conventional thermometers can be used once the food has been removed from the oven.
<b>Straw, wicker, and wood</b>	✓ X	Use only for short-term heating, as these materials can be flammable.

- ✓ : Recommended  
 ✓ X : Use Caution  
 X : Unsafe

# cooking guide

## MICROWAVES

Microwave energy actually penetrates food, attracted and absorbed by the water, fat and sugar content. The microwaves cause the molecules in the food to move rapidly and the rapid movement of these molecules creates friction and the resulting heat cooks the food.

### Cooking meat

Place the meat fat-side down on a microwave-safe roasting rack in a microwave-safe dish. Use narrow strips of aluminum foil to shield any bone tips or thin pieces of meat. Check the temperature in several places before letting the meat stand the recommended time.

The following temperatures are removal temperatures. The temperature of the food will rise during standing time.

FOOD	COOKING TIME/POWER LEVEL	INSTRUCTIONS
Roast beef (boneless) Up to 4 lbs.	<b>Cooking Time:</b> 10-15 min. / lb. for 145 °F - Rare 12-17 min. / lb. for 160 °F - Medium 14-19 min. / lb. for 170 °F - Well Done	Place the roast fat-side down on the roasting rack and cover with wax paper. Turn over halfway through the cooking process. Let stand for 10 to 15 minutes.
	<b>Power Level:</b> High (10) for first 5 minutes, then Medium (5).	
Pork (boneless or bone-in) Up to 4 lbs.	<b>Cooking Time:</b> 15-20 min. / lb. for 170 °F - Well Done	Place the roast fat-side down on the roasting rack and cover with wax paper. Turn over halfway through cooking. Let stand for 10 to 15 minutes.
	<b>Power Level:</b> High (10) for first 5 minutes, then Medium (5).	

Expect a 10°F rise in temperature during standing time.

FOOD		REMOVE FROM OVEN	AFTER STANDING (10 MIN.)
Beef	Rare	135 °F	145 °F
	Medium	150 °F	160 °F
	Well Done	160 °F	170 °F
Pork	Medium	150 °F	160 °F
	Well Done	160 °F	170 °F
Poultry	Dark meat	170 °F	180 °F
	Light meat	160 °F	170 °F

## Cooking poultry

Place the poultry on a microwave-safe roasting rack in a microwave-safe dish and cover with wax paper to prevent spattering. Use aluminum foil to shield the bone tips, thin pieces of meat, or areas that are starting to overcook.

Check the temperature in several places before letting the poultry stand the recommended time.

FOOD	COOKING TIME/POWER LEVEL	INSTRUCTIONS
Whole chicken Up to 4 lbs.	<b>Cooking Time:</b> 6-10 min./lb. 180 °F dark meat 170 °F light meat	Place the chicken breast-side down on the roasting rack. Cover with wax paper. Turn over half way through cooking. Cook until the juices run clear and the meat near the bone is no longer pink. Let stand for 5-10 minutes.
	<b>Power Level:</b> Medium High (7).	
Chicken pieces Up to 2 lbs.	<b>Cooking Time:</b> 6-10 min./lb. 180 °F dark meat 170 °F light meat	Place the chicken bone-side down on the dish, with the thickest portions towards the outside of the dish. Cover with wax paper. Turn over halfway through the cooking process. Cook until the juices run clear and the meat near the bone is no longer pink. Let stand for 5-10 minutes.
	<b>Power Level:</b> Medium High (7).	

## Cooking seafood

Place the fish on a microwave-safe roasting rack in a microwave-safe dish. Use a tight cover to steam the fish. A lighter cover of wax paper or paper towel will decrease steaming. Cook the fish until it flakes easily with a fork. Do not overcook fish; check it after the minimum cook time.

FOOD	COOKING TIME/POWER LEVEL	INSTRUCTIONS
Tuna steaks and salmon steaks Up to 1.5 lbs.	<b>Cooking Time:</b> 7-11 min. / lb.	Arrange the steaks on a roasting rack with the meaty portions towards the outside of the rack. Cover with wax paper. Turn them over when the cooking time is halfway through. Cook until the fish flakes easily with a fork. Let stand for 3-5 minutes.
	<b>Power Level:</b> Medium-High (7).	
Fillets Up to 1.5 lbs.	<b>Cooking Time:</b> 4-8 min. / lb	Arrange the fillets in a baking dish, tucking any thin pieces under. Cover with wax paper. If the fillets are thicker than ½", turn them over when the cook time is halfway. Cook until the fish flakes easily with a fork. Let stand for 2-3 minutes.
	<b>Power Level:</b> Medium-High (7).	
Shrimp Up to 1.5 lbs.	<b>Cooking Time:</b> 4-6½ min. / lb.	Arrange the shrimp in a baking dish without overlapping or layering them. Cover with wax paper. Cook until firm and opaque, stirring 2 or 3 times. Let stand for 5 minutes.
	<b>Power Level:</b> Medium-High (7).	

# cooking guide

---

## Cooking eggs

---



Never cook eggs in their shells, and never warm up boiled eggs in their shells as they can explode. Always pierce whole eggs to keep them from bursting.

## Cooking vegetables

---

Vegetables should be washed prior to cooking. Usually no extra water is needed. If dense vegetables such as potatoes, carrots and green beans are being cooked, add about  $\frac{1}{4}$  cup water.

Small vegetables (sliced carrots, peas, lima beans, etc.) will cook faster than larger ones.

Whole vegetables, such as potatoes, acorn squash or corn on the cob should be arranged in a circle on the turntable before cooking. They will cook more evenly if turned over halfway through the cook time.

Always place vegetables such as asparagus and broccoli with the stem pointing towards the edge of the dish and the tips toward the center.

When cooking cut vegetables, always cover the dish with a lid or vented microwavable plastic wrap.

Whole, unpeeled vegetables such as potatoes, squash, eggplant, etc., should have their skins pierced in several spots before cooking to prevent them from bursting.

For a more even cooking result, stir or rearrange whole vegetables halfway through the cook time.

Generally, the denser the food, the longer the standing time. (Standing time refers to the time necessary for dense, large foods and vegetables to finish cooking after they come out of the oven.) A baked potato can stand on the counter for five minutes before cooking is completed, while a dish of peas can be served immediately.

# cleaning and maintaining your microwave oven

---

Keeping your microwave oven clean improves its performance, wards off unnecessary repairs, and lengthens its life.

## CLEANING THE EXTERIOR

---

It's best to clean spills on the outside of your microwave oven as they occur. Use a soft cloth and warm, soapy water. Rinse and dry.

 Do not get water into the vents. Never use abrasive products or chemical solvents.

CAUTION

## CLEANING THE INTERIOR

---

 Ensure that the microwave oven has cooled down before cleaning it to avoid injury.

CAUTION

 Remove the glass tray from the oven when cleaning the oven or tray. To prevent the tray from breaking, handle it with care and do not put it in water immediately after cooking. Wash the tray carefully in warm sudsy water or in the microwave oven.

CAUTION

Clean the interior surfaces (oven cavity) of your microwave oven periodically to remove any splashes or stains. To remove hardened food articles and remove smells, place 2 cups of water (add lemon juice for extra freshness) in a four-cup measuring glass at High power for 5 minutes or until boiling. Let it stand in the oven for one or two minutes.

## CLEANING THE DOOR AND DOOR SEALS

---

Always ensure that the door seals are clean and that the door closes properly. Take particular care when cleaning the door seals to ensure that no particles accumulate and prevent the door from closing correctly. Wash the glass door with very mild soap and water. Be sure to use a soft cloth to avoid scratching.

 If steam accumulates inside or outside the oven door, wipe with a soft cloth. Steam can accumulate when operating the oven at high humidity and in no way indicates microwave leakage.

## CLEANING THE TURNTABLE AND ROLLER RINGS

---

Clean the roller rings periodically and wash the turntable as required. The turntable can safely be washed in your microwave oven.

# cleaning and maintaining your microwave oven

---

## CLEANING THE GREASE FILTER

---

The grease filter should be removed and cleaned at least once a month.



To avoid risk of personal injury or property damage, do not operate oven hood without filters in place.

1. To avoid risk of personal injury or property damage, do not operate the oven hood without the filters in place.

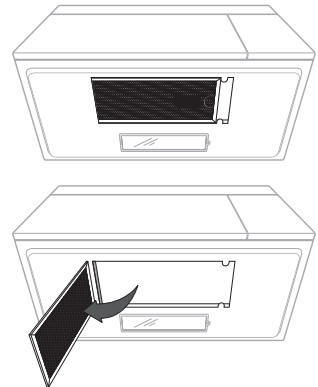

2. Soak the grease filter in hot water and a mild detergent. Rinse well and shake to dry.



Do not use ammonia or put the grease filter in the microwave oven. The aluminum will darken.

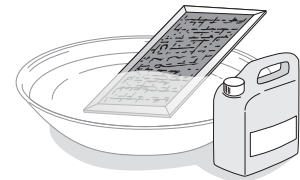

3. To return the filter to its position, slide it into the side slot, then push it upwards and towards the oven center to lock it.

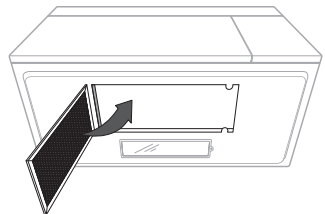

## STORING AND REPAIRING YOUR MICROWAVE OVEN

---

If you need to store your microwave oven for a short or extended period of time, choose a dust-free, dry location. Dust and dampness may adversely affect the ability of the microwave parts.



Do not repair, replace or service any part of your microwave oven yourself. Allow only a qualified service technician to perform repairs. If the oven is faulty and needs servicing, or you are in doubt about its condition, unplug the oven from the power outlet and contact your nearest service center.

Do not use the oven if the microwave oven is damaged, in particular when the door or door seals are damaged. This could be a broken hinge, a worn out seal or distorted/bent casing.

Do not remove the oven from its casing.

This microwave oven is for home use only and is not intended for commercial use.



## REPLACING THE COOKTOP/NIGHT LIGHT

When replacing the night light, make sure that you are wearing gloves to avoid injury from the heat of the bulb.

1. Unplug the oven or turn off the power at the main power supply.
2. Remove the bulb cover, and mounting screws.
3. Replace the bulb with a 40 watt appliance bulb.
4. Replace the bulb cover and mounting screws.
5. Turn the power back on at the main power supply.

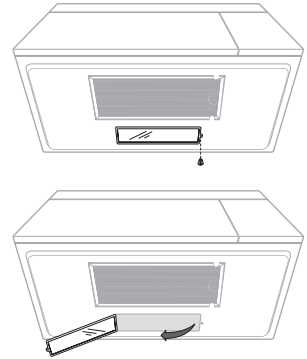

## REPLACING THE OVEN LIGHT

When replacing the oven light, make sure that you are wearing gloves to avoid injury from the heat of the bulb.

1. Unplug the oven plug or turn off the power at the main power supply.
2. Open the door.
3. Remove the vent cover mounting screws (2 middle screws).
4. Slide the vent grille to the left, then pull it straight out.
5. Remove the charcoal filter, if present.
6. Remove the cover. Remove the bulb by turning it gently.
7. Replace the bulb with a 40 watt appliance bulb.
8. Replace the bulb holder.
9. Replace the vent grille and the 2 screws.
10. Turn the power back on.

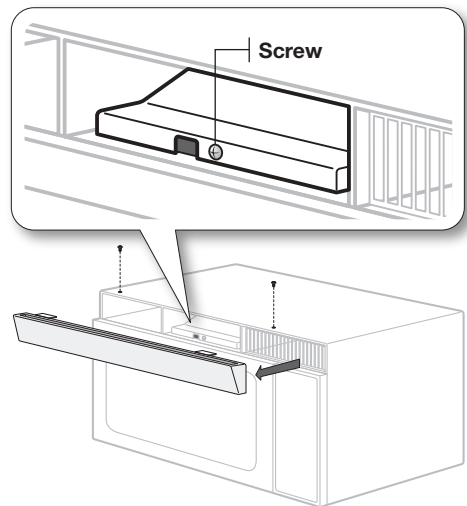

# cleaning and maintaining your microwave oven

---

## REPLACING THE CHARCOAL FILTER

---

If your oven is vented to the inside, the charcoal filter should be replaced every 6 to 12 months and more often if necessary. The charcoal filter cannot be cleaned. To order a new charcoal filter, contact the Parts Department at 1-800-627-4368 or your Samsung dealer. You can also order online at [www.samsungparts.com](http://www.samsungparts.com)

**(Charcoal filter part no.: DE63-00367A)**

1. Unplug the oven plug or turn off the power at the main power supply.
2. Open the door.
3. Remove the vent grille mounting screws (2 middle screws).
4. Slide the vent grille to the left, then pull it straight out.
5. Push the hook and remove the old filter.

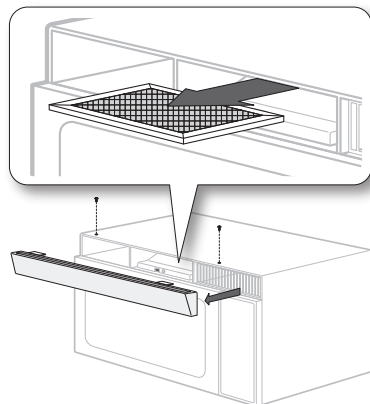

6. Slide a new charcoal filter into place. The filter should rest at the angle shown.
7. Replace the vent grille and 2 screws and close the door. Turn the power back on and set the clock.

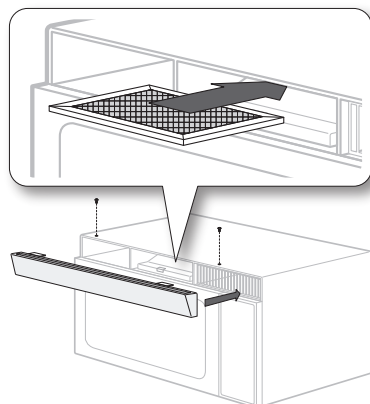

# troubleshooting

---

## CHECK THESE POINTS IF YOUR MICROWAVE OVEN...

---

PROBLEM	SOLUTION
Display is not working.	Make sure the plug is properly connected to a grounded outlet. If the wall outlet is controlled by a wall switch, make sure the wall switch is turned on. Remove the plug from the outlet, wait ten seconds, and plug it in again. Reset the circuit breaker or replace any blown fuses. Plug a different appliance into the outlet. If the other appliance doesn't work, call a qualified electrician to repair the wall outlet. Plug the oven into a different outlet.
The display is working, but the power won't come on.	Make sure the door is closed securely. Check if any packaging material or anything else is stuck in the door seal. Check if the door is damaged. Touch Cancel twice and re-enter all cooking instructions.
Is the power going off before the set time has elapsed?	If there was a power outage, the time indicator will display: 88:88. If no power outage occurred, remove the plug from the outlet, wait ten seconds, and plug it in again. Reset the clock and any cooking instructions. Reset the circuit breaker or replace any blown fuses.
Cooks food too slowly.	Make sure the oven has its own 20 amp circuit line. Operating another appliance on the same circuit can cause a voltage drop. If necessary, move the oven to its own circuit.
Has sparks or arcing.	Remove any metallic utensils, cookware, or metal ties. If using foil, use only narrow strips and allow at least one inch between the foil and the interior oven walls.
The turntable makes noise or becomes stuck.	Clean the turntable, roller ring and oven floor. Make sure the turntable and roller ring are positioned correctly.
Causes TV or radio interference.	This is similar to interference caused by other small appliances, such as hair dryers. Move your microwave (or appliance) away from such appliances, such as your TV or radio.

# appendix

---

## SPECIFICATIONS

---

<b>MODEL NUMBER</b>	<b>SMH8165STG</b>
Oven Cavity	1.6 CuFt
Controls	10 power levels, including defrost
Timer	99 minutes, 99 seconds
Power Source	120 VAC, 60 Hz
Power Consumption	1500 Watts
Power Output	950 Watts
Oven Cavity Dimensions	20 1/4"(W) X 9 1/4"(H) X 14 13/32"(D)
Outside Dimensions	29 7/8"(W) X 16 1/2"(H) X 15 1/16"(D)
Shipping Dimensions	33 3/8"(W) X 19 15/16"(H) X 19 13/32"(D)
Net Weight	STSS : 52.9 lbs Plastic : 52.2 lbs
Gross Weight	STSS : 59.5 lbs Plastic : 58.9 lbs

# warranty

---

## **SAMSUNG OVER-THE-RANGE(OTR) MICROWAVE OVEN**

---

### **Limited warranty to original purchaser**

This SAMSUNG brand product, as supplied and distributed by Samsung Electronics America, Inc. (SAMSUNG) and delivered new, in the original carton to the original consumer purchaser, is warranted by SAMSUNG against manufacturing defects in materials and workmanship for a limited warranty period of:

### **ONE (1) YEAR PARTS AND LABOR, TEN (10) YEARS PARTS WARRANTY FOR MAGNETRON**

This limited warranty begins on the original date of purchase, and is valid only on products purchased and used in the United States. To receive warranty service, the purchaser must contact SAMSUNG for problem determination and service procedures. Warranty service can only be performed by a SAMSUNG authorized service center. The original dated bill of sale must be presented upon request as proof of purchase to SAMSUNG or SAMSUNG's authorized service center.

SAMSUNG will repair or replace this product, at our option and at no charge as stipulated herein, with new or reconditioned parts or products if found to be defective during the limited warranty period specified above. All replaced parts and products become the property of SAMSUNG and must be returned to SAMSUNG. Replacement parts and products assume the remaining original warranty, or ninety (90) days, whichever is longer.

In-home service will be provided during the warranty labor period subject to availability within the contiguous United States. In-home service is not available in all areas. To receive in-home service, the product must be unobstructed and accessible to service personnel. If during in-home service repair can not be completed, it may be necessary to remove, repair and return the product. If in-home service is unavailable, SAMSUNG may elect, at our option, to provide for transportation of our choice to and from a SAMSUNG authorized service center. Otherwise, transportation to and from the SAMSUNG authorized service center is the responsibility of the purchaser.

This limited warranty covers manufacturing defects in materials and workmanship encountered in normal, noncommercial use of this product and shall not apply to the following, including, but not limited to: damage which occurs in shipment; delivery and installation; applications and uses for which this product was not intended; altered product or serial numbers; cosmetic damage or exterior finish; accidents, abuse, neglect, fire, water, lightning or other acts of nature; use of products, equipment, systems, utilities, services, parts, supplies, accessories, applications, installations, repairs, external wiring or connectors not supplied or authorized by SAMSUNG which damage this product or result in service problems; incorrect electrical line voltage, fluctuations and surges; customer adjustments and failure to follow operating instructions, cleaning, maintenance and environmental instructions that are covered and prescribed in the instruction book; problems caused by pest infestations, and overheating or overcooking by user; glass tray or turntable; reduced magnetron power output related to normal aging. SAMSUNG does not warrant uninterrupted or error-free operation of the product.

THERE ARE NO EXPRESS WARRANTIES OTHER THAN THOSE LISTED AND DESCRIBED ABOVE, AND NO WARRANTIES WHETHER EXPRESS OR IMPLIED, INCLUDING, BUT NOT LIMITED TO, ANY IMPLIED WARRANTIES OF MERCHANTABILITY OR FITNESS FOR A PARTICULAR PURPOSE, SHALL APPLY AFTER THE EXPRESS WARRANTY PERIODS STATED ABOVE, AND NO OTHER EXPRESS WARRANTY OR GUARANTY GIVEN BY ANY PERSON, FIRM OR CORPORATION WITH RESPECT TO THIS PRODUCT SHALL BE BINDING ON SAMSUNG. SAMSUNG SHALL NOT BE LIABLE FOR LOSS OF REVENUE OR PROFITS, FAILURE TO REALIZE SAVINGS OR OTHER BENEFITS, OR ANY OTHER SPECIAL, INCIDENTAL OR CONSEQUENTIAL DAMAGES CAUSED BY THE USE, MISUSE OR INABILITY TO USE THIS PRODUCT, REGARDLESS OF THE LEGAL THEORY ON WHICH THE CLAIM IS BASED, AND EVEN IF SAMSUNG HAS BEEN ADVISED OF THE POSSIBILITY OF SUCH DAMAGES. NOR SHALL RECOVERY OF ANY KIND AGAINST SAMSUNG BE GREATER IN AMOUNT THAN THE PURCHASE PRICE OF THE PRODUCT SOLD BY SAMSUNG AND CAUSING THE ALLEGED DAMAGE. WITHOUT LIMITING THE FOREGOING, PURCHASER ASSUMES ALL RISK AND LIABILITY FOR LOSS, DAMAGE OR INJURY TO PURCHASER AND PURCHASER'S PROPERTY AND TO OTHERS AND THEIR PROPERTY ARISING OUT OF THE USE, MISUSE OR INABILITY TO USE THIS PRODUCT SOLD BY SAMSUNG NOT CAUSED DIRECTLY BY THE NEGLIGENCE OF SAMSUNG. THIS LIMITED WARRANTY SHALL NOT EXTEND TO ANYONE OTHER THAN THE ORIGINAL PURCHASER OF THIS PRODUCT, IS NONTRANSFERABLE AND STATES YOUR EXCLUSIVE REMEDY.

Some states do not allow limitations on how long an implied warranty lasts, or the exclusion or limitation of incidental or consequential damages, so the above limitations or exclusions may not apply to you. This warranty gives you specific legal rights, and you may also have other rights which vary from state to state.

To obtain warranty service, please contact SAMSUNG at:

**1-800-SAMSUNG (7267864) and [www.samsung.com](http://www.samsung.com)**

memo

---

memo

---



QUESTIONS OR COMMENTS

COUNTRY	CALL	OR VISIT US ONLINE AT
CANADA	1-800-SAMSUNG (7267864)	<a href="http://www.samsung.com">www.samsung.com</a>

Code No.: DE68-00355D