

SMH7185  
SMH7187

# Microwave Oven

## user manual

imagine the possibilities

Thank you for purchasing this Samsung  
product. Please register your product at  
[www.samsung.com/global/register](http://www.samsung.com/global/register)

**SAMSUNG**

# features of your new microwave oven

---

- **Professional Design**

The new Stainless Steel Samsung Over The Range (OTR) oven has a clean, professional look that matches your other kitchen appliances perfectly, providing a harmonious and complete kitchen solution.

- **Turbo vent**

With 400 CFM of ventilation power, your new Over The Range (OTR) oven offers optimal cooking conditions by absorbing smoke and odor from the cook-top. It is also as silent as other OTRs with much lower ventilation power. Experience maximum power with no additional noise!

- **Large Interior capacity**

With its 1.8 cu.ft capacity, your OTR oven delivers plenty of space for all your cooking needs. A big capacity combined with 1,100 watts of output guarantees superior cooking results.

- **Auto Louver (SMH7187STG Only)**

The Motorized Louver opens automatically only when the OTR is working. Therefore, you can prevent contamination and also easily and speedily cleans the OTR.

- **Sensor Cooking**

Don't know how to cook? Samsung's new OTR sensor technology offers preset functions resulting in perfectly cooked dishes every time. Simply select a cooking menu, and the cooking results will astound you.

- **VFD display**

With an informative VFD (Vacuum Fluorescent Display), your OTR lets you easily use all available functions.











# important safety instruction

Throughout this manual, you'll see Warning and Caution notes.

These warnings, cautions, and the important safety instructions that follow do not cover all possible conditions and situations that may occur.

It's your responsibility to use common sense, caution, and care when installing, maintaining, and operation your microwave oven. Samsung is not liable for damages resulting from improper use.

## WHAT THE ICONS AND SIGNS IN THIS MANUAL MEAN:

 WARNING	<b>WARNING:</b> Hazards or unsafe practices that may result in severe personal injury or death.
 CAUTION	<b>CAUTION:</b> Hazards or unsafe practices that may result in minor personal injury or property damage.
	Do not attempt or use.
	Do not repair.
	Do not touch.
	Be careful
	Follow directions explicitly.
	Unplug the power plug from the wall socket.
	Make sure the machine is grounded to prevent electric shock.
	Call the service center for help.
	Note

## PRECAUTIONS TO AVOID POSSIBLE EXPOSURE TO EXCESSIVE MICROWAVE ENERGY:

-  Do not attempt to operate this microwave oven with the door open since open-door operation can result in harmful exposure to microwave energy. It is important not to defeat or tamper with the safety interlocks.

Do not place any object between the microwave oven front face and the door or allow soil or cleaner residue to accumulate on sealing surfaces.

### SAVE THESE INSTRUCTIONS

# important safety instruction

---

Do not operate the microwave oven if it is damaged. It is particularly important that the microwave oven door close properly and that there is no damage to the

- Door (bent or dented),
- Hinges and latches (broken or loosened),
- Door seals and sealing surfaces.

 The microwave oven should not be adjusted or repaired by anyone except properly qualified service personnel.

## IMPORTANT SAFETY INSTRUCTIONS

---

When using any electrical appliance, basic safety precautions should be followed, including the following:



### WARNING

 Always observe Safety Precautions when using your oven. Never try to repair the oven on your own - there is dangerous voltage inside. If the oven needs to be repaired, call 1-800-SAMSUNG (7267864) for the name of an authorized service center near you.

## TO REDUCE RISK OF BURNS, ELECTRIC SHOCK, FIRE, PERSONAL INJURY OR EXPOSURE TO EXCESSIVE MICROWAVE ENERGY:

---

 Read all safety instructions before using the appliance.

Read and follow the specific “PRECAUTIONS TO AVOID EXPOSURE TO EXCESSIVE MICROWAVE ENERGY” on page 3.

This appliance must be grounded. Connect only to properly grounded outlets. See “IMPORTANT GROUNDING INSTRUCTIONS” on page 7 of this manual.

Install or place this appliance only in accordance with the installation instructions provided.

Use this appliance only for its intended use as described in the manual. Do not use corrosive chemicals or vapors in this appliance. This type of oven is specifically designed to heat, cook, or dry food. It is not designed for industrial or laboratory use.

As with any appliance, close supervision is necessary when used by children.

Keep the inside of the oven clean. Food particles or spattered oils stuck to the oven walls or floor can cause paint damage and reduce the efficiency of the oven.

Keep the power cord away from heated surfaces.

## SAVE THESE INSTRUCTIONS

When cleaning the door and oven surfaces, use only mild, nonabrasive soaps or detergents applied with a sponge or soft cloth.

Remove lids from baby food before heating. After heating baby food, stir well and test temperature by tasting before serving.

This over-the-range oven was designed for use over ranges no wider than 36 inches. It may be installed over both gas and electric cooking equipment.

 Liquids, such as water, coffee, or tea are able to be overheated beyond the boiling point without appearing to be boiling. Visible bubbling or boiling when the container is removed from the microwave oven is not always present. THIS COULD RESULT IN VERY HOT LIQUIDS SUDDENLY BOILING OVER WHEN THE CONTAINER IS DISTURBED BY A SPOON OR OTHER UTENSILS, INSERTED INTO THE LIQUID.

Carefully remove container coverings, directing steam away from your hands and face.

Some items, like whole eggs and food in sealed containers, may explode if heated in this oven.

 Do not operate this appliance if it has a damaged cord or plug, if it is not working properly, or if it has been damaged.

Do not cover or block any of the openings on this appliance.

Do not store this appliance outdoors. Do not use near water - for example, near a kitchen sink, in a wet basement, or near a swimming pool, etc.

Do not immerse the power cord or plug in water.

Do not let the power cord hang over edge of table or counter.

Do not try to preheat the microwave oven or operate it while empty.

Do not cook without the glass tray in place on the oven floor. Food will not cook properly without the tray in place.

Do not defrost frozen beverages in narrow-necked bottles. The containers can break.

Dishes and containers may become hot. Handle with care.

Do not mount unit over or near any portion of a heating or cooking appliance.

Do not mount over a sink.

Do not store anything directly on top of the appliance when it is in operation.

 This appliance should be serviced only by qualified service personnel. Contact the nearest authorized service facility for examination, repair, or adjustment.

## SAVE THESE INSTRUCTIONS

# important safety instruction

---

## **TO REDUCE THE RISK OF FIRE IN THE OVEN:**

---

 Remove wire twist-ties from plastic cooking bags before placing bags in oven.

 Do not use the oven compartment for storage purposes. Do not leave paper products, cooking utensils, or food in the oven when not in use.

Do not overcook food. Watch appliance carefully if paper, plastic, or other combustible materials are inside.

 If materials inside the oven ignite, keep the oven door closed, turn the oven off, disconnect the power cord, or shut off the power at the fuse or circuit breaker panel. If the door is opened, the fire may spread.

## **TO REDUCE THE RISK OF INJURY TO PERSONS:**

---

 Stir the liquid both before and halfway through heating it.

After heating, allow the container to stand in the microwave oven for a short time before removing the container.

 Do not use straight-sided containers with narrow necks.

Do not overheat liquids.

 Use extreme care when inserting a spoon or other utensils into the container.

**SAVE THESE INSTRUCTIONS**



# IMPORTANT GROUNDING INSTRUCTIONS

---

-  This appliance must be grounded. In the event of an electrical short circuit, grounding reduces the risk of electric shock by providing an escape wire for the electrical current. This appliance is equipped with a power cord that includes a grounding wire and a grounding plug. The plug must be plugged into an outlet that is properly installed and grounded. Plug the three-prong power cord into a properly grounded outlet of standard 115-120 voltage, 60 Hz. Your oven should be the only appliance on this circuit.



## **WARNING**

---

-  **CAUTION** Improper use of the grounding plug can result in a risk of electric shock. Consult a qualified electrician or servicer if you do not understand the grounding instructions or if you are not sure if the appliance is properly grounded.
-  Do not use an extension cord with this appliance. If the power cord is too short, have a qualified electrician or service technician install an outlet near the appliance.  
  
Do not cut or remove the third (ground) prong from the power cord under any circumstances.
-  Connect the oven only to a 15A dedicated circuit.

## THE VENT FAN

---

-  The fan will operate automatically under certain conditions. Take care to prevent the starting and spreading of accidental cooking fires while the vent fan is in use.  
  
In the event of a grease fire on the surface units below the microwave oven, smother a flaming pan on the surface unit by covering the pan completely with a lid, a cookie sheet or a flat tray.  
  
Clean Ventilating Hoods Frequently - Grease should not be allowed to accumulate on the ventilating hood.  
  
When flaming foods under the hood, turn the fan on.
-  Use care when cleaning the vent-hood filter. A corrosive cleaning agent, such as lyebased oven cleaner, may damage the filter.
-  Never leave surface units beneath your microwave oven unattended at high heat settings. Boilovers cause smoking and greasy spillovers that may ignite and spread if the microwave vent fan is operating. To minimize automatic fan operation, use adequate sized cookware and use high heat on surface units only when necessary.

**SAVE THESE INSTRUCTIONS**

# contents

---

## **SETTING UP YOUR NEW MICROWAVE OVEN**

10

- 10 Checking the parts
- 11 Warranty and service information
- 11 Setting up your microwave oven
- 12 Turning on the power for the first time
- 12 My Choice
- 13 Setting the time
- 13 Help button
- 13 Child lock
- 14 Checking the control panel

## **USING YOUR MICROWAVE OVEN**

16

- 16 Using the Kitchen Timer button
- 16 Using the One Minute+ button
- 16 Using the More/Less buttons
- 16 Using the Turbo Vent button
- 16 Using the Light button
- 17 Using the Turntable On/Off button
- 17 Using the metal shelf
- 18 Using the Sensor Cook buttons
- 20 Using the Sensor Reheat button
- 21 Using the Auto/Power Defrost button
- 22 Using the Handy Helper button
- 23 Using the Kids Meals button
- 24 Using the Snack Bar button
- 25 Microwave cooking times & power levels
- 26 Using the Custom Cook button

## **COOKWARE GUIDE**

27

- 27 Microwave-safe utensils

## **COOKING GUIDE**

29

- 29 General microwave tips
- 30 Cooking meat
- 31 Cooking poultry
- 31 Cooking seafood
- 32 Cooking eggs
- 32 Cooking vegetables
- 33 Recipes



## **CLEANING AND MAINTAINING YOUR MICROWAVE OVEN**

35

- 35** Cleaning the exterior
- 35** Cleaning the interior
- 35** Cleaning the turntable and roller rings
- 36** Storing and repairing your microwave oven
- 36** Replacing the cooktop/night light
- 36** Replacing the oven light
- 37** Cleaning the grease filter
- 38** Replacing the charcoal filter

## **TROUBLESHOOTING**

39

- 39** Check these points if your microwave oven...

## **APPENDIX**

40

- 40** Specifications

## **WARRANTY**

41

# setting up your new microwave oven

Be sure to follow these instructions closely so that your new microwave oven works properly.

## CHECKING THE PARTS

Carefully unpack your microwave oven, and make sure you've received all the parts shown below. If your microwave oven was damaged during shipping, or if you do not have all the parts, contact Samsung Customer Service. (Refer to the "WARRANTY AND SERVICE INFORMATION" on page 11.)

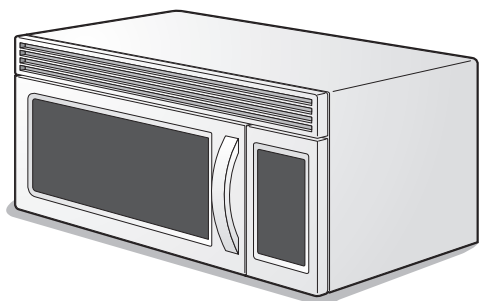

**Microwave oven (SMH7185)**

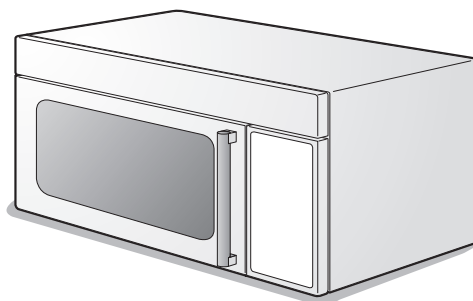

**Microwave oven (SMH7187)**

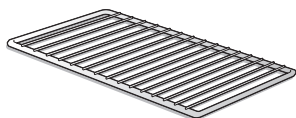

**Shelf**  
DE75-00036A

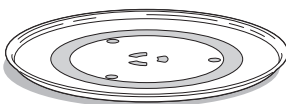

**Glass Tray**  
DE74-20002C



**Roller Guide Ring**  
DE97-00368A

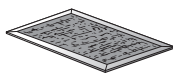

**Grease Filters (2ea)**  
DE63-00196A

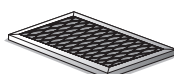

**Charcoal filter**  
DE63-00367D

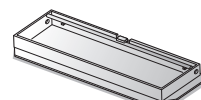

**Exhaust adaptor**  
DE92-90242D



**Hardware kit (Screws & Brackets)**  
DE92-90505E

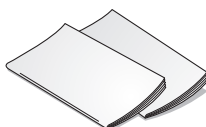

**Manuals**  
(User DE68-00356W & Installation DE68-00357N)

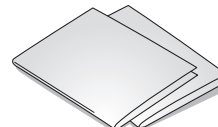

**Templates**  
(Top DE68-03144B & Wall DE68-03142B)

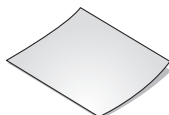

**Registration Card**  
6801-001581

## WARRANTY AND SERVICE INFORMATION

To help us to serve you better, please complete the enclosed registration card and promptly return it by mail. If the registration card is missing, you can call Samsung Electronics, Inc., at **1-800-SAMSUNG (726-7864)** or register online at [www.samsung.com/global/register](http://www.samsung.com/global/register). When contacting Samsung, please provide the specific model and serial number information which is usually located on the back or bottom of the product. Please record these numbers below, along with the other requested information. Keep this information in a safe place as a permanent record of your purchase to aid in identification in case of theft or loss, and a copy of your sales receipt as a proof of purchase if warranty service is needed.

**MODEL NUMBER** \_\_\_\_\_

**SERIAL NUMBER** \_\_\_\_\_

**DATE PURCHASED** \_\_\_\_\_

**PURCHASED FROM** \_\_\_\_\_

Warranty service can only be performed by a Samsung Authorized Service Center. If you should require warranty service, provide the above information with a copy of your sales receipt to the Samsung Authorized Service Center.

For service assistance and the location of the nearest service center, please call **1-800-SAMSUNG (7267864)**.

## SETTING UP YOUR MICROWAVE OVEN

1. Open the door by pulling the handle on the right side of the door.
2. Wipe the inside of the oven with a damp cloth.

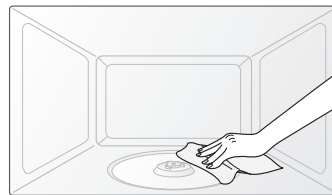

3. Install the pre-assembled ring into the indentation at the center of the microwave oven.

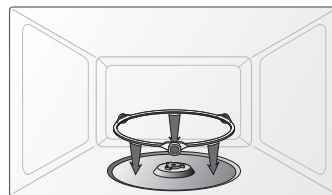

4. Place the glass tray securely in the center of the pre-assembled roller ring.

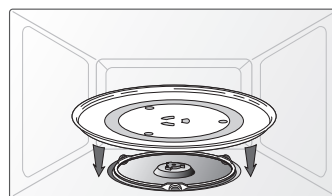

### Installing the metal shelf

When you need to use the Metal Shelf, place it on the plastic hooks inside your oven and make sure it is positioned properly to avoid arcing and damaging your oven.



CAUTION Make sure the shelf is positioned properly inside the microwave to prevent damage to the oven from arcing.

# setting up your new microwave oven

---

## TURNING ON THE POWER FOR THE FIRST TIME

---

The first time you plug the power cord into an outlet the display turns on after four seconds with: *ENJOY YOUR COOKING* - - - - *PRESS MY CHOICE FOR PERSONAL OPTIONS*

 This will also occur after a power interruption

## MY CHOICE

---

Your new microwave oven can be customized to suit your personal preferences. Simply press the **My Choice** button to configure the following options. The options are summarized in the following table:

NUMBER	MY CHOICE OPTIONS	DESCRIPTION
1	Language choice	The language options are English, French or Spanish.
2	Display weight	Select either pounds or kilograms.
3	Remind end signal	The remind end signal can be turned on and off.
4	Daylight savings time adjustment	The time can be increased/decreased by selecting Daylight Savings Time.  The time needs to be set to use this function.

### Selecting the display language

---

1. Press the **My Choice** button immediately after plugging in your microwave and then press the number **1** button. The display will show: *LANGUAGE CHOICE PRESS MY CHOICE*
2. Press the **My Choice** button. The display will show: *ENGLISH PRESS START*
3. Press the **My Choice** button repeatedly to cycle through the language options: *ENGLISH, FRENCH, SPANISH*
4. Press the **Start** button to select your language.

### Selecting the weight units

---

You can choose between pounds (LBS) and kilograms (KG).

1. Press the **My Choice** button and then press the number **2** button. The display shows: *LBS OR KG PRESS MY CHOICE*.
2. Press the **My Choice** button. The display shows: *LBS*.
3. Press the **My Choice** button repeatedly to select the weight measurements you wish to use.
4. Press the **Start** button to select the weight units.

### Setting the remind end signal

---

The Remind End Signal can be turned On or Off.

1. Press the **My Choice** button and then press the number **3** button. The display shows: *REMINDE END SIGNAL ON/OFF PRESS MY CHOICE*.
2. Press the **My Choice** button repeatedly to select either ON or OFF. The display will display your selection.
3. Press the **Start** button to make your selection.

## SETTING THE TIME

---

Your microwave oven is equipped with a built-in clock. Set the clock when first installing your microwave oven and after a power failure. The time is displayed whenever the microwave oven is not being used.

1. Press the **Clock** button.
2. The display will show *SELECT AM/PM*. Use the **Clock** button to select AM/PM.
3. Use the number buttons to enter the current time. You need to press at least three numbers to set the clock. For example, if the current time is 5:00, press 5, 0, 0. The display will show: *500*.
4. Press the **Clock** button again.
5. A colon appears indicating that the time is set.

 To check the time while cooking, press the **Clock** button.

### Adjusting for Daylight Saving Time

---

1. Press the **My Choice** button and then the number 4 button. The display will show: *DAYLIGHT SAVING TIME ON/OFF PRESS MY CHOICE*.
2. Press the **My Choice** button repeatedly to toggle between ON and OFF.
3. Press the **Start** button. The time of day will either increase (ON) or decrease by one hour (OFF).

 If the clock is set to standard time, this function allows convenient time changes without needing to reset the clock. Daylight Saving Time begins for most of the United States at 2 a.m. on the second Sunday of March, and reverts to Standard time at 2 a.m. on the first Sunday in November.

## HELP BUTTON

---

Your microwave offers helpful instructions for many of the procedures of your microwave.

When you need information on features as well as helpful hints, press the **Help** button followed by the button for which you require information on. Help information is available in 3 languages (English, French and Spanish).

## CHILD LOCK

---

The Child Lock function allows you to lock the buttons so that the microwave oven cannot be operated accidentally. The oven can be locked at any time.

### Activating/Deactivating

If you want to activate or deactivate the child lock function, press the **My Choice** button and the **5** button at the same time for 3 seconds.

The display will show *CHILD LOCK ON* when the oven is locked and then returns to displaying the time.

# setting up your new microwave oven

## CHECKING THE CONTROL PANEL

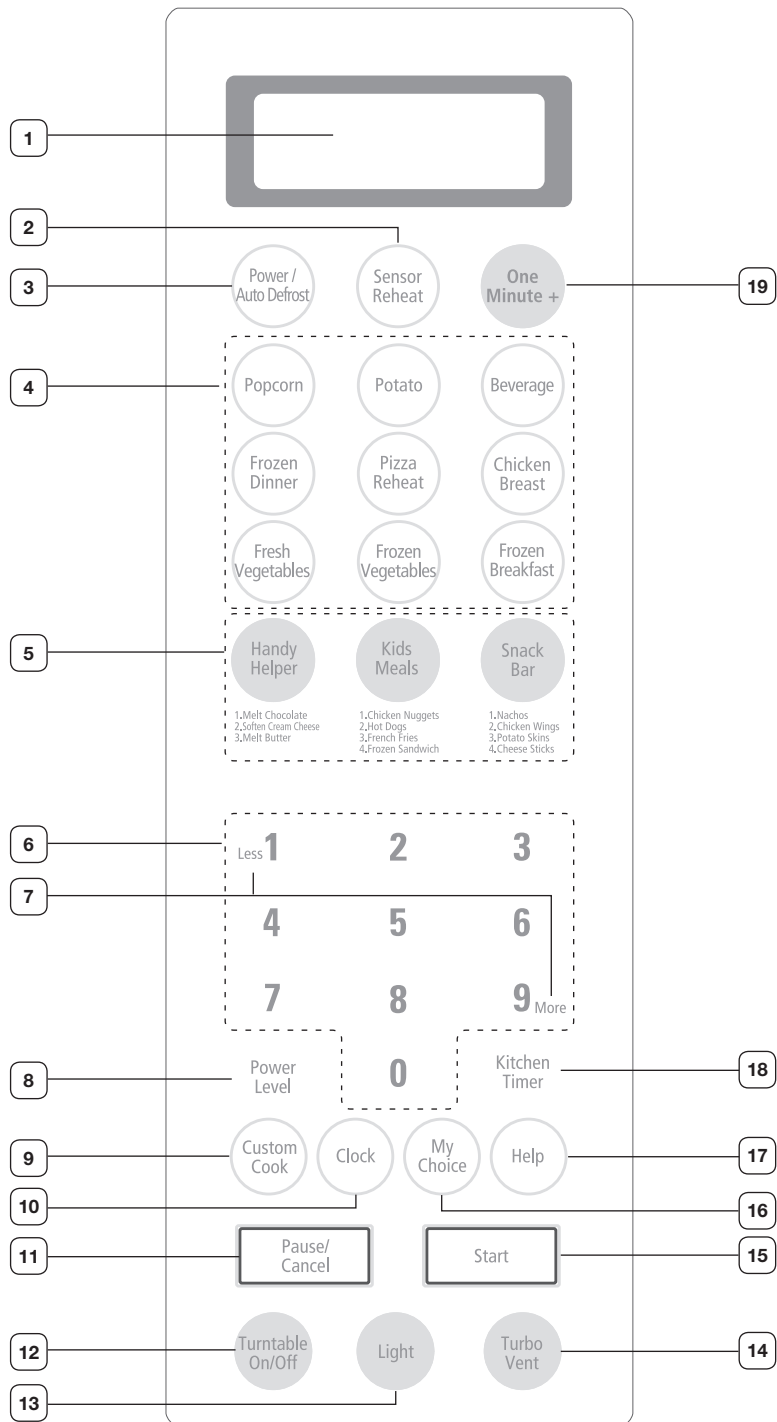

1	<b>DISPLAY</b>	The display displays the time when the microwave is not being used, as well as your selected cooking time settings and cooking functions.
2	<b>SENSOR REHEAT BUTTON</b>	Use this button to reheat dinner plates, casseroles, and pasta.
3	<b>POWER/AUTO DEFROST BUTTON</b>	Use this button to defrost food according to its weight.
4	<b>SENSOR COOK BUTTON</b>	Use these buttons to select a preset cooking cycle.
5	<b>HANDY HELPER, KIDS MEALS, SNACK BAR BUTTONS</b>	Press these buttons to cook specific foods. The items are listed under the buttons.
6	<b>NUMBER BUTTONS</b>	Use the number buttons to enter the cooking time, power level, quantity, or weight.
7	<b>MORE/LESS BUTTONS</b>	The <b>More/Less</b> buttons allow you to adjust the pre-set cooking times once you have started cooking.
8	<b>POWER LEVEL BUTTON</b>	Press this button to select a cooking power level.
9	<b>CUSTOM COOK BUTTON</b>	Press this button to store cooking instructions or recall them later from memory.
10	<b>CLOCK BUTTON</b>	Use this button to enter the time.
11	<b>PAUSE/CANCEL BUTTON</b>	Use this button to stop/pause the oven or to clear all entries.
12	<b>TURNTABLE ON/OFF BUTTON</b>	Use this button to turn the turntable on or off.
13	<b>LIGHT BUTTON</b>	The <b>Light</b> button allows you to select a light setting for your microwave.
14	<b>TURBO VENT BUTTON</b>	The vent removes steam and other vapors from the cooking surface.
15	<b>START BUTTON</b>	Press this button to start a selected function. If you open the door after the oven begins to cook, close the door and press the <b>Start</b> button again.
16	<b>MY CHOICE BUTTON</b>	Use this button to select your personal preferences such as the language, weight units, and whether to use the remind end signal and the daylight savings time.
17	<b>HELP BUTTON</b>	Use this button to get information on features as well as helpful hints.
18	<b>KITCHEN TIMER BUTTON</b>	This microwave allows you to use your microwave oven as a timer. Use the Kitchen Timer button for timing up to 99 minutes 99 seconds.
19	<b>ONE MINUTE+ BUTTON</b>	This simplified control saves you time, letting you quickly start cooking at 100% power without the need to press the <b>Start</b> button.



Refer to "Using your microwave oven" below for detailed information on the buttons described in the table above.

# using your microwave oven

---

Cooking has never been easier than with your new Samsung microwave oven. The following section describes everything you need to know about using your microwave oven.

## USING THE KITCHEN TIMER BUTTON

---

This microwave allows you to use your microwave oven as a timer. Use the Kitchen Timer for timing up to 99 minutes, 99 seconds.

1. Use the number buttons to set the length of time you want the timer to run.
2. Press the **KITCHEN TIMER** button.
3. The display counts down and beeps when the time has elapsed.
4. To cancel timer setting: Press **PAUSE/CANCEL** button twice.

## USING THE ONE MINUTE+ BUTTON

---

This simplified control saves you time, letting you quickly start cooking at 100% power without the need to press the **Start** button.

1. Press the **One Minute+** button for each minute you wish the food to be cooked for. For example, press it twice to cook it for two minutes. The time is displayed and the oven starts automatically.
2. Add minutes to a cooking program already in progress by pressing the **One Minute+** button for every additional minute you wish to add.

## USING THE MORE/LESS BUTTONS

---

The **More (9)/Less (1)** buttons allow you to adjust the pre-set cooking times. They only work for the "Sensor Reheat", "Sensor Cooking(except Beverage)", "One Minute+", "Custom Cook", "Kitchen Timer", "Handy Helper", "Kids Meals", "Snack Bar" and "Time Cook" modes. Use the **More (9)/Less (1)** buttons only after you have already begun cooking with one of these modes.

1. Use the **More (9)** button to add time to increase the time of an automatic cooking procedure.
2. Use the **Less (1)** button to decrease the time of an automatic cooking procedure.
  - Each time you press the More (9) button while cooking manually, the current cooking time increases by 10 seconds. Press the Less (1) button to decrease it by 10 seconds.

## USING THE TURBO VENT BUTTON

---

The vent removes steam and other vapors from the cooking surface. You can manually select the vent setting.

1. Press the **Turbo Vent** button once for turbo fan speed.
2. Press the **Turbo Vent** button twice for high fan speed.
3. Press the **Turbo Vent** button three for low fan speed.
4. Press the **Turbo Vent** button four times to turn the fan off.

 If the temperature becomes too hot around the microwave oven, the fan in the vent hood will automatically turn on at the low setting to cool the oven. The fan will automatically turn off when the oven has cooled down sufficiently. This is an automated process and cannot be turned off. The fan may stay on for 30 minutes or more after the cooktop and microwave controls are turned off. The Vent Fan will only operate in Hi/Low modes while the microwave is working.

## USING THE LIGHT BUTTON

---

The **Light** button allows you to select a light setting for your microwave.

1. Press the **Light** button once to turn the light on.
2. Press the **Light** button twice for the night light.
3. Press the **Light** button three times to turn the light completely off.



## USING THE TURNTABLE ON/OFF BUTTON

For best cooking results leave the turntable on. However, for large dishes it can be turned off. Press the TURNTABLE ON/OFF button to turn the turntable on or off.

 The turntable may become too hot to touch. Use pot holders to touch the turntable during and after cooking.

## USING THE METAL SHELF

Use the metal shelf to cook more than one item at the same time.

-  CAUTION
- Do not use a microwave browning dish on the shelf. The shelf could overheat.
  - Do not use the oven with the shelf on the microwave floor. This could damage the microwave.
  - Use pot holders when handling the shelf as it may be hot.
  - Do not use the metal shelf when cooking popcorn.

Food cooks best on the turntable.

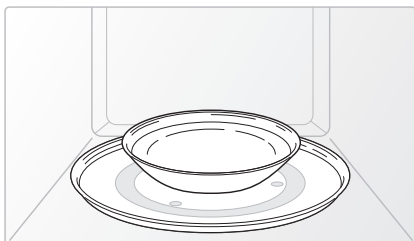

**For best results**

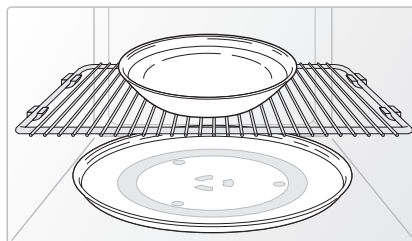

**Uneven results**

The shelf gives you the option to reheat more than one dish at the same time.

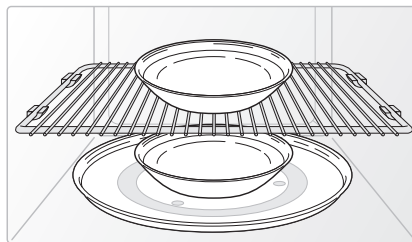
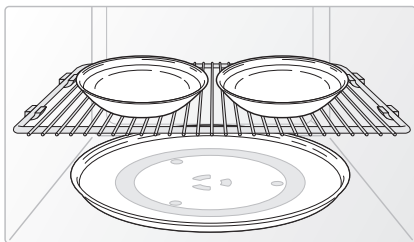

## Reheating food

To reheat food on 2 levels or to reheat food on the lower level:

- Multiply the reheating time by 1½.
- Switch places halfway through the reheating process.

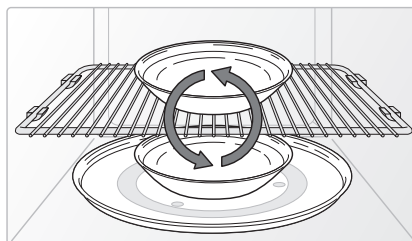
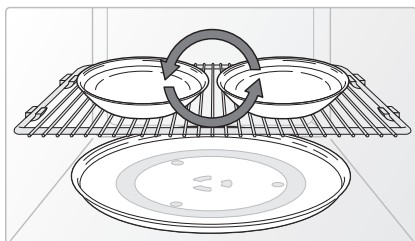

# using your microwave oven

## USING THE SENSOR COOK BUTTONS

The **Sensor Cook** buttons consist of frequently used settings allowing you to select them quickly and conveniently. Use the **More (9)/Less (1)** buttons to set your temperature preference. If the food is not thoroughly cooked or reheated when using the auto cook feature, complete the cooking process by selecting a power level and cooking time.

 Do not continuously use the **Sensor Cook** buttons. The oven must cool for 5 minutes between uses or the food will overcook.

### Sensor cooking utensils & covers

To obtain good cooking results using these functions, follow the directions for selecting the appropriate containers and covers in the Cookware section on p26.

Always use microwave-safe containers and cover with a lid or plastic wrap. When using plastic wrap, turn back one corner to allow steam to escape.

 Always use the proper lid for the container. If the utensil does not have its own lid, use plastic wrap.

 Fill containers at least half full.

 Foods that require stirring or rotating should be stirred or turned at the end of the Sensor Cook cycle, when the time has started to count down on the display.

 Do not use the Auto Sensor cooking feature continuously. Wait 5 minutes before selecting another sensor cooking operation.

 To avoid poor results, do not use the Auto Sensor when the room ambient temperature is too high or too low.

### Sensor cooking table

FOOD	AMOUNT	PROCEDURE
Popcorn	3.0 - 3.5 oz 1 package	Use only one microwave popcorn bag at a time. Be careful when removing and opening the heated bag from the oven. Let the oven cool for at least 5 minutes before using it again.
Potatoes	1 to 6 potatoes.	Pierce each potato several times with a fork. Place on the turntable in a spoke-like fashion. After cooking, let the potatoes stand for 3-5 minutes. Let the oven cool for at least 5 minutes before using it again.
Beverage	8 oz.	Use a measuring cup or mug and do not cover. Place the beverage in the oven. After heating, stir well. Let the oven cool for at least 5 minutes before using it again.
Frozen dinner	8 to 14 oz.	Remove the food from its wrapping and follow the instructions on the box for covering and standing instructions. Let the oven cool for at least 5 minutes before using it again.

FOOD	AMOUNT	PROCEDURE
<b>Pizza reheat</b>	1 to 3 slices	Place 1-3 pizza slices on a microwave-safe plate with the wide ends of the slices towards the outside edge of the plate. Do not let the slices overlap. Do not cover. Let the oven cool for at least 5 minutes before using it again. Use the <b>More (9)</b> button to increase the reheating time for pizzas with thick crusts.
<b>Frozen vegetables</b>	1 to 4 servings	Place the frozen vegetables in a microwave-safe ceramic, glass or plastic dish and add 2-4 tbs. water. Cover with a lid or vented plastic wrap while cooking and stir before standing for 3-5 minutes. Let the oven cool for at least 5 minutes before using it again. Use the <b>More (9)</b> button when cooking dense vegetables such as carrots or broccoli spears.
<b>Chicken breast</b>	8 to 16 oz.	Place the chicken breasts on a microwave safe plate and cover with plastic wrap. Cook to an internal temperature of 170 °F. Let stand for 5 minutes. Use the MORE button to increase the cooking time for larger or thicker chicken breasts.
<b>Frozen breakfast</b>	4 to 8 oz.	Follow the package instructions for covering and standing. Use this button for frozen sandwiches, breakfast entrees, pancakes, waffles, etc. Let the oven cool for at least 5 minutes before using it again.
<b>Fresh vegetables</b>	1 to 4 cups	Place the fresh vegetables in a microwave-safe ceramic, glass or plastic dish and add 2-4 tbs. water. Cover with a lid or vented plastic wrap while cooking and stir before standing. Let the oven cool for at least 5 minutes before using it again.

The correct food temperature varies from person to person. Use the **More (9)/Less (1)** buttons to select your personal temperature preference.

# using your microwave oven

## USING THE SENSOR REHEAT BUTTON

Heating leftovers and precooked foods is easy with your new microwave. By actually sensing the humidity that escapes as the food is heated, the oven's heating time is automatically adjusted depending on the type and amount of precooked food.

 All food must already be precooked. Plates of food and casseroles should be stored at refrigerator temperature.

Press the **Sensor Reheat** button to begin reheating your precooked food. The display will show *REHEAT* and the oven will start automatically. Use the **More (9)/Less (0)** buttons to adjust the heating time. If you want to check the current time at any time while reheating, press the **Clock** button.

### Sensor reheating table

Follow the instructions below when reheating different types of food.

FOOD	AMOUNT	PROCEDURE
<b>Plates of food</b>	1 serving (1 plate)	Use only precooked, refrigerated foods. Cover the plate with vented plastic wrap or waxed paper tucked under the plate. If the food is not as hot as you would like after using the Sensor Reheat function, continue heating using additional time and power.  <b>Contents:</b> 3-4 oz. meat, poultry or fish (up to 6 oz. with bone) ½ cup starch (potatoes, pasta, rice, etc.) ½ cup vegetables (about 3 - 4 oz.)
<b>Casserole Reheating pasta</b>	1 to 4 servings	Cover the plate with a lid or vented plastic wrap. If the food is not as hot as you would like after using the "Sensor Reheat" function, continue heating using additional time and power. Stir the food once before serving.  <b>Contents:</b> Casserole, refrigerated foods. Pasta: canned spaghetti and ravioli

## USING THE AUTO/POWER DEFROST BUTTON

To thaw frozen foods, enter the weight of the food, and the microwave automatically sets the defrosting time, power level and standing time. The Power Defrost function is automatically activated when defrosting foods that weigh less than 1.0 lbs. The Auto Defrost function is automatically activated when defrosting foods that weigh over 1.0 lbs.

 The “Auto Defrost” function (for foods over 1.0 lbs) takes several minutes longer than the “Power Defrost” function (for food under 1.0 lbs).

1. Press the **Power/Auto Defrost** button. The display shows: *0.5 LB (0.2 Kg* if you have set your oven to metric measurement).
2. Press the **Power/Auto Defrost** button repeatedly to set the weight of your food. The weight is increased in 0.5 lb increments, up to 6.0 lbs. You can also use the number buttons to directly enter the weight of the food. The oven calculates the defrosting time and starts automatically.
3. The oven will beep and the display will read *TURN THE FOOD OVER* twice during the defrosting process. Open the oven door, and turn the food over.
4. If you do not turn the food over when *TURN THE FOOD OVER* is displayed, the oven will be paused until the **Start** button is pressed.

### Auto/Power defrosting table

Follow the instructions below when defrosting different types of food.

FOOD	AMOUNT	PROCEDURE
<b>Roast Beef, Pork</b>	2.5-6.0 lbs.	Start with the food placed fat side down. After each stage, turn the food over and shield any warm portions with narrow strips of aluminum foil. Let stand, covered for 10-20 minutes.
<b>Steaks, Chops, Fish</b>	0.5-3.0 lbs.	After each stage, rearrange the food. If there are any warm or thawed portions of food, shield them with narrow, flat pieces of aluminum foil. Remove any pieces of food that are nearly defrosted. Let stand, covered for 5-10 minutes.
<b>Ground Meat</b>	0.5-3.0 lbs.	After each stage, remove any pieces of food that are nearly defrosted. Let stand, covered with foil for 5-10 minutes.
<b>Whole Chicken</b>	2.5-6.0 lbs.	Remove giblets before freezing poultry. Start defrosting with the breast side down. After the first stage, turn the chicken over and shield any warm portions with narrow strips of aluminum foil. After the second stage, again shield any warm portions with narrow strips of aluminum foil. Let stand, covered for 30-60 minutes in the refrigerator.
<b>Chicken Pieces</b>	0.5-3.0 lbs.	After each stage, rearrange or remove any pieces of food that are nearly defrosted. Let stand for 10-20 minutes.

 Check the food when you hear the oven signal. After the final stage, small sections may still be icy; let them stand to continue the thawing process. Do not defrost until all ice crystals have thawed. Shielding roasts and pieces of steak using small pieces of foil prevents the edges from being cooked before the center of the food has defrosted. Use narrow, flat, smooth strips of aluminum foil to cover edges and thinner sections of the food.

# using your microwave oven

## USING THE HANDY HELPER BUTTON

1. Press the **Handy Helper** button. The display will show: *MELT CHOCOLATE 1 CUP CHIPS*. (Refer to the Handy helper table). Press the button repeatedly to cycle through the available items.
2. Press the number **1** or **2** buttons to select the serving size. Only number **1** (serving) is available for the Melt Chocolate and Soften Cream Cheese options. (Refer to the Handy helper table for the serving size).
3. Press the **Start** button to begin cooking.





### Handy helper table

ITEM	AMOUNT	REMARKS
Melt chocolate	1 cup chips or 1 square	Place the chocolate chips or squares in a microwave-safe container. When the oven beeps, stir the chocolate and restart the oven. Stir and let stand for 1 minute.
Soften cream cheese	8-oz package	Unwrap the cream cheese and place on a microwave-safe container. Cut in half vertically. Let stand for 2 minutes.
Melt butter	1 stick (serving) 2 sticks (serving)	Remove the wrapping and cut the butter in half vertically. Place the butter in a dish and cover with wax paper. Stir well after finishing and let stand for 1-2 minutes.

## USING THE KIDS MEALS BUTTON

1. Press the **Kids Meals** button. The display will show *CHICKEN NUGGETS*. (Refer to the Kids meals table). Press the button repeatedly to cycle through the available items.
2. Press the number **1** or **2** buttons to select the serving size. (Refer to the Kids meals table for the serving size.)
3. Press the **Start** button to begin cooking.

### Kids meals table

ITEM	AMOUNT	REMARKS
<b>Chicken nuggets (frozen)</b>	1 serving 2 servings	Place a paper towel on a plate and arrange the nuggets in a spoke-like fashion on the paper towel. Do not cover. Let stand for 1 minute after heating.  Refer to the package directions for the serving size and the amount of food. Use the More button to add additional cooking time if the chicken nuggets are not hot enough.
<b>Hot dogs</b>	2 hot dogs 4 hot dogs	Pierce the hot dogs and place them on a plate. When the oven beeps, add the buns and restart the oven. Let stand for 1 minute after heating.  For the best texture, the buns should be added to the hot dogs when the oven beeps.
<b>French fries (frozen)</b>	1 serving 2 servings	Place two paper towels on a microwave-safe plate and arrange the french fries on the towels without letting them overlap. Blot the fries with additional paper towels after removing from the oven. Let stand for 1 minute.  refer to the directions on the packaging for the serving size and the amount of food.
<b>Frozen sandwiches (in crisping sleeve) 9-oz package size</b>	1 sandwich 2 sandwiches	Place the frozen sandwich in a susceptor "crisping sleeve" (which is in a package) and place on a microwave-safe plate. Remove from the "crisping sleeve". Let stand for 2 minutes after heating.  For large sandwiches, use the <b>More (9)</b> button to increase the heating time.

# using your microwave oven

## USING THE SNACK BAR BUTTON

1. Press the **Snack Bar** button. The display will show *NACHOS 1 SERVING*. (Refer to the snack bar table). Press the button repeatedly to cycle through the available items.
2. Press the number **1** or **2** buttons to select the serving size. Only number **1** (serving) is available for Nachos. (Refer to the snack bar table for the serving size).
3. Press the **Start** button to begin cooking.

### Snack bar table

ITEM	AMOUNT	REMARKS
Nachos	1 serving	Place the nachos on a plate without letting them overlap. Sprinkle cheese evenly over them. <b>Contents:</b> 2 cups tortilla chips 1/3 cup grated cheese
Chicken wings	5-6 oz. 7-8 oz.	Use precooked, refrigerated chicken wings. Place the chicken wings around the plate in a spoke-like fashion and cover with wax paper. Let stand for 1 to 2 minutes.
Potato skins	1 cooked potato 2 cooked potatoes	Cut the cooked potato into 4 even wedges. Scoop or cut out the potato flesh, leaving about a 1/4 in. of skin. Place the skins in a spoke-like fashion around the plate. Sprinkle with bacon, onions and cheese. Do not cover. Let stand 1 to 2 minutes.
Cheese sticks (frozen)	5-7 pcs 8-10 pcs	Place the cheese sticks on a plate in a spoke-like fashion. Do not cover. Let stand for 1 to 2 minutes after heating.  The sizes of the cheese sticks may vary. For smaller size cheese nuggets, use the <b>Less (1)</b> button to decrease the heating time. For larger size cheese sticks, use the <b>More (9)</b> button to increase the heating time.



## MICROWAVE COOKING TIMES & POWER LEVELS

Your oven allows you to set three different cooking stages, each with their own time length and power level. The power level lets you control the heating intensity from Warm (1) through to High (0).

### One-stage cooking

For simple one-stage cooking, you only need to set the cooking time. The power level is automatically set to High. If you want to set the power level to any other level, use the **Power Level** button.

1. Use the number buttons to set a cooking time. You can enter a time from one second right up to 99 minutes and 99 seconds. To select a time greater than one minute, enter the seconds too. (For example, to set a cooking time of 20 minutes, enter **2, 0, 0, 0**.)
2. If you want to set the power level to a level other than High, press the **Power Level** button and use the number buttons to enter the power level. The display will show: *PRESS START OR ENTER NEXT STAGE COOKING TIME*.
3. Press the **Start** button to begin cooking. If you want to change the power level, press the **Pause/Cancel** button before you press the **Start** button, and enter all the instructions again.

 Some recipes require different cooking stages at different temperatures. Your microwave allows you to set multiple cooking stages.

### Multi-stage cooking

1. Follow steps 1 and 2 from the “One-stage cooking” section. The display will show: *PRESS START OR ENTER NEXT STAGE COOKING TIME* appears in the display.

 When selecting more than one cooking stage, the **Power Level** button must be pressed before the second cooking stage can be entered.

 Press the **Power Level** button twice to set the power level to High for a cooking stage.

2. Use the number buttons to set a second cooking time.
3. Press the **Power Level** button, then use the number buttons to set the power level for the second cooking stage. The display shows the selected power level and then displays *PRESS START OR ENTER NEXT STAGE COOKING TIME*.
4. Press the **Start** button to begin cooking, or repeat steps 2 and 3 to set a cooking time and power level for a third cooking stage. When finished, press the **Start** button.

### Power Levels

The 10 power levels allow you to choose the optimal power level for your cooking needs.

POWER LEVEL			
1	Warm	6	Simmer
2	Low	7	Medium high
3	Defrost	8	Reheat
4	Medium low	9	Sauté
5	Medium	0	High

# using your microwave oven

---

## USING THE CUSTOM COOK BUTTON

---

The **Custom Cook** button lets you store a customized set of cooking instructions, and recall this setting later from memory to begin cooking quickly.

 Only one set of instructions can be stored at a time.

1. Press the **Custom Cook** button. Press the button twice to delete the previous Custom Cook setting. The display shows *ENTER COOKING TIME AND POWER*.
  2. Use the number buttons to enter the cooking time. The display will show the set time.
  3. Press the **Power Level** button and use the number buttons to enter the power level. The display will show the selected power level. You can set the power level from 0 to 9.
  4. Press the **Custom Cook** button again. The display will read *CUSTOM RECIPE SAVED*.
  5. To retrieve a Custom Recipe, press the **Custom Cook** button, then press the **Start** button.
- You can only recall one stored recipe at a time.

You can check the power level anytime while cooking by pressing the **Power Level** button.



# cookware guide

To cook food in the microwave oven, the microwaves must be able to penetrate the food without being reflected or absorbed by the dish.

It is important to choose the correct cookware, therefore look for cookware that is marked microwave-safe.

The following table lists various types of cookware and indicates if and how they should be used in a microwave oven.

## MICROWAVE-SAFE UTENSILS

If you are not sure whether an item is microwave-safe or not, you can perform the following simple test:

1. Place 1 cup of water (in a glass-measuring cup) inside your oven next to the item to be tested.
2. Press the **One Minute+** button once to heat them both for one minute at high power.

After one minute, the water should be warm and the item you are testing should be cool. If the dish is warm, then it is absorbing microwave energy and is not microwave-safe.

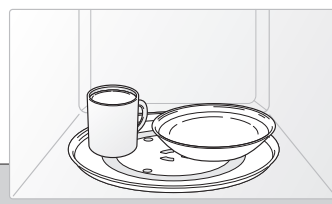

COOKWARE	MICROWAVE-SAFE	COMMENTS
<b>Aluminum foil</b>	✓ X	Can be used in small quantities to protect areas against overcooking. Arcing can occur if the foil is too close to the oven wall or if too much foil is used.
<b>Browning plate</b>	✓	Do not preheat for more than eight minutes.
<b>Ceramic, porcelain, and stoneware</b>	✓	Porcelain, pottery, glazed earthenware and bone china are usually suitable, unless decorated with a metal trim.
<b>Disposable polyester cardboard</b>	✓	Some frozen foods are packaged in these materials.
<b>Fast-food packaging</b>		
Polystyrene cups/containers	✓	Can be used to warm food. Overheating may cause the polystyrene to melt.
Paper bags or newspaper	X	May catch fire.
Recycled paper or metal trims	X	May cause arcing.
<b>Glassware</b>		
Oven-to-table ware	✓	Can be used, unless decorated with a metal trim.
Fine glassware	✓	Can be used to warm foods or liquids. Delicate glass may break or crack if heated suddenly.
Glass jars	✓	Regular glass is too thin to be used in a microwave, and can shatter.
<b>Metal</b>		

<b>COOKWARE</b>	<b>MICROWAVE-SAFE</b>	<b>COMMENTS</b>
Dishes, Utensils	✗	May cause arcing or fire.
Freezer bag twist ties	✗	
<b>Paper</b>		
Plates, cups, napkins and kitchen paper	✓	For short cooking times and warming. Also to absorb excess moisture.
Recycled paper	✓	Do not use recycled paper towels, which may contain metal and may catch fire or cause arcing.
<b>Plastic</b>		
Containers	✓	Can be used if heat-resistant thermoplastic. Some plastics may warp or discolor at high temperatures. Do not use Melamine plastic.
Cling film	✓	Can be used to retain moisture. Avoid wrapping the food too tight. Take care when removing the film as hot steam will escape.
Freezer bags	✓ ✗	Only if boilable or oven-proof. Should not be airtight. Pierce with a fork, if necessary.
<b>Wax or grease-proof paper</b>	✓	Can be used to retain moisture and prevent spattering.
<b>Thermometer</b>	✓	Use only those marked “Microwave-safe” and follow the directions. Check the temperature in several places. Conventional thermometers can be used once the food has been removed from the oven.
<b>Straw, wicker, and wood</b>	✓ ✗	Use only for short-term heating, as these materials can be flammable.

- ✓ : Recommended
- ✓ ✗ : Use Caution
- ✗ : Unsafe

# cooking guide

---

Microwave energy actually penetrates food, attracted and absorbed by the water, fat and sugar content. The microwaves cause the molecules in the food to move rapidly. The rapid movement of these molecules creates friction and the resulting heat cooks the food.

## GENERAL MICROWAVE TIPS

---

Dense foods, such as potatoes, take longer to heat than lighter foods. Foods with a delicate texture should be heated at a low power level to avoid becoming tough.

Foods with a non-porous skin such as potatoes or hot dogs, should be pierced to prevent bursting.

Putting heating oil or fat in the microwave is not recommended. Fat and oil can suddenly boil over and cause severe burns.

Some ingredients heat faster than others. For example the jelly in the jelly doughnut will be hotter than the dough. Keep this in mind to avoid burns.

The altitude and the type of cookware you are using can affect the cooking time. When using a new recipe, use the minimum cooking time and check the food occasionally to prevent overcooking.

Home canning in the microwave oven is not recommended because not all harmful bacteria may be destroyed by the microwave heating process.

Although microwaves do not heat the cookware, the heat from the food is often transferred to the cookware. Always use pot holders when removing food from the microwave and instruct children to do the same.

Making candy in the microwave is not recommended as candy can be heated to very high temperatures. Keep this in mind to avoid injury.

## Cooking techniques

---



If the oven is set to cook for more than 25 minutes, it will automatically adjust to 70 percent power after 25 minutes to avoid overcooking.

### Stirring

Stir foods such as casseroles and vegetables while cooking to distribute heat evenly. Food at the outside of the dish absorbs more energy and heats more quickly, so stir from the outside towards the center. The oven will turn off when you open the door to stir your food.

### Arrangement

Arrange unevenly shaped foods, such as chicken pieces or chops, with the thicker, meatier parts toward the outside of the turntable where they receive more microwave energy. To prevent overcooking, place thin or delicate parts towards the center of the turntable.

### Shielding

Shield food with narrow strips of aluminum foil to prevent overcooking. Areas that need shielding include poultry wing-tips, the ends of poultry legs, and corners of square baking dishes. Use only small amounts of aluminum foil. Larger amounts can damage your oven.

### Turning

Turn foods over midway through the cooking cycle to expose all parts to the microwave energy. This is especially important with large items such as roasts.

### Standing

Foods cooked in the microwave build up internal heat and continue to cook for a few minutes after the oven stops. Let foods stand to complete the cooking process, especially foods such as roasts and whole vegetables. Roasts need this time to complete cooking in the center without overcooking the outer areas. All liquids, such as soup or hot chocolate should be shaken or stirred when cooking is complete. Let liquids stand a moment before serving. When heating baby food, stir well and test the temperature before serving.

## Adding moisture

Microwave energy is attracted to water molecules. Food that is uneven in moisture content should be covered or allowed to stand so that the heat disperses evenly. Add a small amount of water to dry food to help it cook.

## Venting

After covering a dish with plastic wrap, vent the plastic wrap by turning back one corner to let excess steam escape.

## COOKING MEAT

Place the meat fat side down on a microwave-safe roasting rack in a microwave-safe dish. Use narrow strips of aluminum foil to shield any bone tips or thin pieces of meat. Check the temperature in several places before letting the meat stand the recommended time.

The following temperatures are the removal temperatures. The temperature of the food will rise during standing time.

FOOD	COOKING TIME/POWER LEVEL	INSTRUCTIONS
<b>Roast beef (boneless)</b> Up to 4 lbs.	<b>Cooking Time:</b> 7-11 min. / lb. for 145 °F - Rare 8-12 min. / lb. for 160 °F - Medium 9-14 min. / lb. for 170 °F - Well Done	Place the roast fat-side down on the roasting rack and cover with wax paper. Turn over halfway through the cooking process. Let stand for 10 to 15 minutes.
	<b>Power Level:</b> High (0) for first 5 minutes, then Medium (5).	
<b>Pork (boneless or bone-in)</b> Up to 4 lbs.	<b>Cooking Time:</b> 11-15 min. / lb. at 170 °F Well Done	Place the roast fat-side down on the roasting rack and cover with wax paper. Turn over halfway through cooking process. Let stand for 10 to 15 minutes.
	<b>Power Level:</b> High (0) for first 5 minutes, then Medium (5).	

Expect a 10 °F rise in temperature during the standing time.

FOOD		REMOVE FROM OVEN	AFTER STANDING (10 MIN.)
<b>Beef</b>	<b>Rare</b>	135 °F	145 °F
	<b>Medium</b>	150 °F	160 °F
	<b>Well Done</b>	160 °F	170 °F
<b>Pork</b>	<b>Medium</b>	150 °F	160 °F
	<b>Well Done</b>	160 °F	170 °F
<b>Poultry</b>	<b>Dark meat</b>	170 °F	180 °F
	<b>Light meat</b>	160 °F	170 °F

## COOKING POULTRY

Place the poultry on a microwave-safe roasting rack in a microwave-safe dish and cover with wax paper to prevent spattering. Use aluminum foil to shield the bone tips, thin pieces of meat, or areas that may start to overcook.

Check the temperature in several places before letting the poultry stand the recommended time.

FOOD	COOKING TIME/POWER LEVEL	INSTRUCTIONS
Whole chicken Up to 4 lbs.	<b>Cooking Time:</b> 6-9 min. / lb. 180 °F dark meat 170 °F light meat	Place the chicken breast-side down on the roasting rack. Cover with wax paper. Turn over half way through cooking process. Cook until the juices run clear and the meat near the bone is no longer pink. Let stand for 5-10 minutes.
	<b>Power Level:</b> Medium High (7).	
Chicken pieces Up to 2 lbs.	<b>Cooking Time:</b> 6-9 min. / lb. 180 °F dark meat 170 °F light meat	Place the chicken bone-side down on the dish, with the thickest portions towards the outside of the dish. Cover with wax paper. Turn over halfway through the cooking process. Cook until the juices run clear and the meat near the bone is no longer pink. Let stand for 5-10 minutes.
	<b>Power Level:</b> Medium High (7).	

## COOKING SEAFOOD

Place the fish on a microwave-safe roasting rack in a microwave-safe dish. Use a tight cover to steam the fish. A lighter cover of wax paper or paper towel will decrease steaming. Cook the fish until it flakes easily with a fork. Do not overcook fish; check it after the minimum cooking time.

FOOD	COOKING TIME/POWER LEVEL	INSTRUCTIONS
Tuna steaks and salmon steaks Up to 1.5 lbs.	<b>Cooking Time:</b> 6-10 min. / lb.	Arrange the steaks on a roasting rack with the meaty portions towards the outside of the rack. Cover with wax paper. Turn them over halfway through the cooking process. Cook until the fish flakes easily with a fork. Let stand for 3-5 minutes.
	<b>Power Level:</b> Medium-High (7).	
Fillets Up to 1.5 lbs.	<b>Cooking Time:</b> 3-7 min. / lb.	Arrange the fillets in a baking dish, tucking any thin pieces under. Cover with wax paper. If the fillets are thicker than ½ in., turn them over halfway through the cooking process. Cook until the fish flakes easily with a fork. Let stand for 2-3 minutes.
	<b>Power Level:</b> Medium-High (7).	
Shrimp Up to 1.5 lbs.	<b>Cooking Time:</b> 3-5½ min. / lb.	Arrange the shrimp in a baking dish without overlapping or layering them. Cover with wax paper. Cook until firm and opaque, stirring 2 or 3 times. Let stand for 5 minutes.
	<b>Power Level:</b> Medium-High (7).	

# cooking guide

---

## COOKING EGGS

---

You can use your microwave oven to cook eggs. Cook them until they are just set as they become tough if they are overcooked.



Never cook eggs in their shells, and never warm up hard-boiled eggs in their shells as they may explode. Always pierce whole eggs to keep them from bursting.

## COOKING VEGETABLES

---

Vegetables should be washed prior to cooking. Usually, no extra water is needed. If dense vegetables such as potatoes, carrots and green beans are being cooked, add about ¼ cup water.

Small vegetables (sliced carrots, peas, lima beans, etc.) will cook faster than larger ones.

Whole vegetables, such as potatoes, acorn squash or corn on the cob, should be arranged in a circle on the turntable before cooking. They will cook more evenly if turned over halfway through the cooking process.

Always place vegetables such as asparagus and broccoli with the stems pointing towards the edge of the dish and the tips toward the center.

When cooking cut vegetables, always cover the dish with a lid or vented microwavable plastic wrap.

Whole, unpeeled vegetables such as potatoes, squash, eggplant, etc., should have their skins pierced in several spots before cooking to prevent them from bursting.

For a more even cooking result, stir or rearrange whole vegetables halfway through the cook time.

Generally, the denser the food, the longer the standing time. (The standing time refers to the time necessary for dense, large foods and vegetables to finish cooking after they come out of the oven.) A baked potato can stand on the counter for five minutes before cooking is completed, while a dish of peas can be served immediately.



## RECIPES

---

### Beef and barley stew

---

1½ lbs. beef stew cubes, cut into ½-inch pieces  
½ cup chopped onion  
2 Tbs. all-purpose flour  
1 Tbs. Worcestershire sauce  
1 can (13.75-14.5 oz.) beef broth  
2 medium carrots, cut into ½-inch slices (about 1 cup)  
½ cup barley  
1 bay leaf  
¼ tsp. pepper  
1 pkg. (9-10 oz.) frozen peas, thawed

---

1. In a 2-quart casserole, combine the beef, onion, flour, and Worcestershire sauce and mix well. Cover with lid. Cook at High for 6 to 8 minutes until the beef is no longer pink, stirring once.
2. Stir in beef broth, carrots, barley, bay leaves, and pepper. Cover with lid. Cook at Medium for 1 to 1½ hours until carrots and beef are tender, stirring 2 to 3 times.
3. Stir in peas. Cover with lid. Cook at Medium for 10 minutes. Let stand for 10 minutes. Remove bay leaves before serving.

Makes 6 servings.

### Broccoli and cheese casserole

---

¼ cup butter or margarine  
¼ cup chopped onion  
1½ Tbs. flour  
½ tsp. salt  
¼ tsp. dry mustard  
1/8 tsp. pepper  
1½ cups milk  
¼ cup chopped red pepper  
8 oz. (2 cups) cheddar cheese, shredded  
1 pkg. (9-10 oz.) frozen chopped broccoli, thawed  
4 cups cooked spiral shaped pasta (8 oz. dry)

---

1. In a 2-quart casserole, cook butter and onion at High for 1 to 2 minutes until the onion is soft, stirring once.
2. Add flour, salt, mustard, and pepper; mix well. Cook at High for 30 to 60 seconds until mixture boils. Stir in milk until smooth.
3. Stir in red pepper. Cook at High for 2 to 3 minutes until mixture boils and thickens slightly, stirring twice. Stir in cheese until melted.
4. Add broccoli and pasta, mix well. Cover with lid. Cook at High for 4 to 6 minutes until heated through, stirring once. Stir before serving.

Makes 6 servings.

# cooking guide

---

## Warm potato salad

---

2 lbs. small red potatoes, cut into ½-inch pieces  
4 slices bacon (uncooked), cut into ½-inch pieces  
¼ cup chopped onion  
2 tsp. sugar  
1 tsp. salt  
1 tsp. flour  
½ tsp. celery seed  
1/8 tsp. pepper  
2½ Tbs. apple cider vinegar

---

1. In a 2-quart casserole, combine the potatoes and ¼ cup water. Cover with lid. Cook at High until the potatoes are tender (7-10 minutes); stir twice. Drain and set aside to cool slightly.
2. In a medium bowl, cook the bacon at High until crisp (2½-3½ minutes); stir once. Place the bacon on a paper towel. Reserve 1 Tbs. drippings.
3. Combine the drippings and onion. Cover with plastic wrap; turn a corner back to vent steam. Cook at High until tender (1½-2½ minutes); stir once.
4. Stir in sugar, salt, flour, celery seed, and pepper. Cook at High until mixture boils (30-40 seconds). Stir in vinegar and ½ cup water. Cook at High until liquid boils and thickens slightly (1-2 minutes); stir once. Add bacon to dressing. Pour dressing over potatoes. Stir well.

Makes 6 servings.

## Black bean soup

---

1 cup chopped onion  
1 clove garlic, minced  
2 cans (15 oz. each) black beans, drained  
1 can (14-16 oz.) stewed tomatoes, chopped  
1 can (13.75-14.5 oz.) chicken broth  
1 can (7-8.5 oz.) corn  
1 can (4 oz.) chopped green chilies  
1-2 tsp. ground cumin, or to taste \*\*\* what does 'or to taste' mean? \*\*\*

---

1. Place the onion and garlic in a 3-quart casserole. Cover with lid. Cook at High for 2 to 4 minutes until tender.
2. Add one can of beans, and mash the beans with a fork. Add remaining ingredients and mix well.
3. Cook uncovered at High for 10 minutes; stir. Reduce power to Medium and cook for 5 minutes. Stir before serving.

Makes about 2 quarts.

# cleaning and maintaining your microwave oven

---

Keeping your microwave oven clean improves its performance, wards off unnecessary repairs, and lengthens its life.

## CLEANING THE EXTERIOR

---

It's best to clean spills on the outside of your microwave oven as they occur. Use a soft cloth and warm, soapy water. Rinse and dry.

 Do not get water into the vents. Never use abrasive products or chemical solvents such as ammonia or alcohol as they can damage the appearance of your microwave.

### Cleaning under your microwave oven

---

Regularly clean grease and dust from the bottom of your microwave using a solution of warm water and detergent.

### Cleaning the control panel

---

Wipe with a damp cloth and dry thoroughly. Do not use cleaning sprays, large amounts of soap and water, abrasives or sharp objects on the panel as it is easily damaged.

### Cleaning the door and door seals

---

Always ensure that the door seals are clean and that the door closes properly. Take particular care when cleaning the door seals to ensure that no particles accumulate and prevent the door from closing correctly. Wash the glass door with very mild soap and water. Be sure to use a soft cloth to avoid scratching.

 If steam accumulates inside or outside the oven door, wipe with a soft cloth. Steam can accumulate when operating the oven at high humidity and in no way indicates microwave leakage.

## CLEANING THE INTERIOR

---

 Ensure that the microwave oven has cooled down before cleaning it to avoid injury.

 Remove the glass tray from the oven when cleaning the oven or tray. To prevent the tray from breaking, handle it with care and do not put it in water immediately after cooking. Wash the tray carefully in warm sudsy water or in the dishwasher.

Clean the interior surfaces (oven cavity) of your microwave oven periodically to remove any splashes or stains. To remove hardened food articles and remove smells, place 2 cups of water (add lemon juice for extra freshness) in a four-cup measuring glass (why a 4-cup measuring glass) at High power for 5 minutes or until boiling. Let it stand in the oven for one or two minutes.

## CLEANING THE TURNTABLE AND ROLLER RINGS

---

Clean the roller rings periodically and wash the turntable as required. The turntable can safely be washed in your dishwasher.

# cleaning and maintaining your microwave oven

---

## STORING AND REPAIRING YOUR MICROWAVE OVEN

---

If you need to store your microwave oven for a short or extended period of time, choose a dust-free, dry location. Dust and dampness may adversely affect the ability of the microwave parts.

 **WARNING** Do not repair, replace or service any part of your microwave oven yourself. Allow only a qualified service technician to perform repairs. If the oven is faulty and needs servicing, or you are in doubt about its condition, unplug the oven from the power outlet and contact your nearest service center.

Do not use the oven if the microwave oven is damaged, in particular when the door or door seals are damaged. This could be a broken hinge, a worn out seal or distorted/bent casing.

Do not remove the oven from its casing.

This microwave oven is for home use only and is not intended for commercial use.

## REPLACING THE COOKTOP/NIGHT LIGHT

---

When replacing the night light, make sure that you are wearing gloves to avoid injury from the heat of the bulb.

1. Unplug the oven or turn off the power at the main power supply.
2. Remove the screw from the light cover and lower the cover.
3. Replace bulb with 40 watt incandescent bulb.
4. Replace the light cover and mounting screw.
5. Turn the power back on at the main power supply.

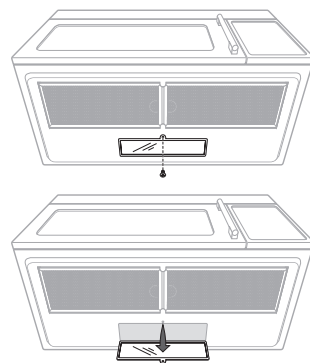

## REPLACING THE OVEN LIGHT

---

When replacing the night light, make sure that you are wearing gloves to avoid injury from the heat of the bulb.

1. Unplug the oven plug or turn off the power at the main power supply.
2. Remove the two screws holding the top vent grille in place.
3. Next, remove the screw located above the door near the center of the oven that holds the light housing.
4. Remove the light housing and light bulb.
5. Insert the new light bulb.
6. Replace the light housing and screw.
7. Replace the vent cover and the 2 mounting screws.
8. Turn the power back on.

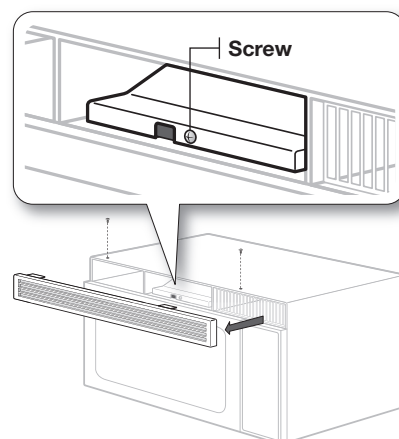

## CLEANING THE GREASE FILTER

Your microwave oven has two metal reusable grease filters. The grease filters should be removed and cleaned at least once a month, or as required.



**WARNING** To avoid risk of personal injury or property damage, do not operate the oven hood without filters in place.

1. To remove the filter, slide it to the left (or right) using the tab.

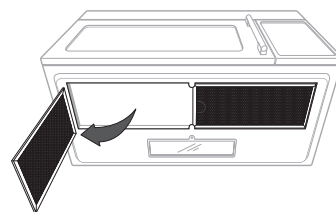
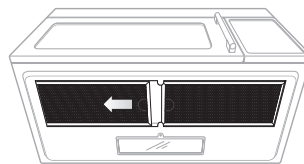

2. Soak the grease filter in hot water and a mild detergent. Rinse well and shake to dry. Brushing the filter lightly can remove embedded dirt.



**WARNING** Do not use ammonia or put the grease filter in the microwave oven. The aluminum will darken.

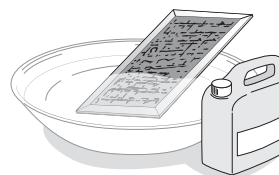

3. To return the filter to its position, slide it into the frame slot on the left (or right), then push it upwards and to the right (or left) to lock it.

# cleaning and maintaining your microwave oven

---

## REPLACING THE CHARCOAL FILTER

---

If your oven is not vented to the outside, the charcoal filter should be replaced when it is noticeably dirty or discolored (every 6 to 12 months, and more often if necessary). The charcoal filter cannot be cleaned. To order a new charcoal filter, contact the Parts Department at your nearest Authorized Service Center or Samsung dealer. **(Charcoal filter part no.: DE63-00367D)**

1. Unplug the oven plug or turn off the power at the main power supply.
2. Remove the two screws from the top vent grille.
3. Slide the filter towards the front of the oven and then remove it.
4. Remove the plastic and any other outer wrapping from the new filter.

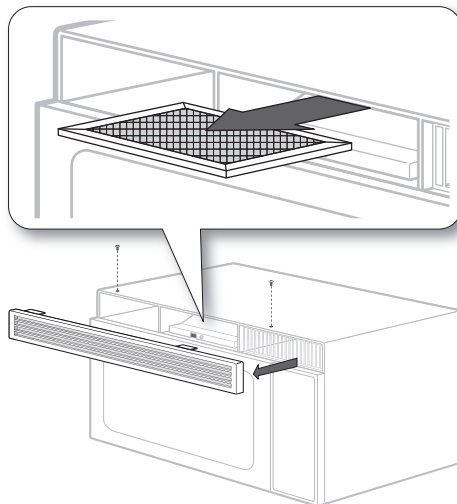

5. Insert the new filter into the top opening of the oven as shown. The filter should rest at an angle on 2 side support tabs and in front of the right rear tab.
6. Replace the vent grille and the 2 screws.
7. Turn the power back on and set the clock.

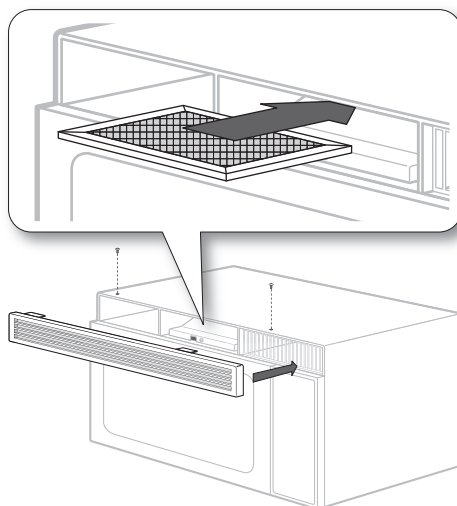

# troubleshooting

## CHECK THESE POINTS IF YOUR MICROWAVE OVEN...

PROBLEM	SOLUTION
The display and/or the oven is not working.	Make sure the plug is properly connected to a grounded outlet. If the wall outlet is controlled by a wall switch, make sure the wall switch is turned on. Remove the plug from the outlet, wait ten seconds, and plug it in again. Reset the circuit breaker or replace any blown fuses. Plug a different appliance into the outlet. If the other appliance doesn't work, call a qualified electrician to repair the wall outlet. Plug the oven into a different outlet.
The display is working, but the power won't come on.	Make sure the door is closed securely. Check if any packaging material or anything else is stuck in the door seal. Check if the door is damaged. Touch Cancel twice and enter all the cooking instructions again.
Is the power going off before the set time has elapsed?	If there was a power outage, the time indicator will display: 88:88. If no power outage occurred, remove the plug from the outlet, wait ten seconds, and plug it in again. Reset the clock and any cooking instructions. Reset the circuit breaker or replace any blown fuses.
Cooks food too slowly.	Make sure the oven has its own 20 amp circuit line. Operating another appliance on the same circuit can cause a voltage drop. If necessary, move the oven to its own circuit.
Has sparks or arcing.	Remove any metallic utensils, cookware, or metal ties. If using foil, use only narrow strips and allow at least one inch between the foil and the interior oven walls.
The turntable makes noise or becomes stuck.	Clean the turntable, roller ring and oven floor. Make sure the turntable and roller ring are positioned correctly.
Causes TV or radio interference.	This is similar to interference caused by other small appliances, such as hair dryers. Move your microwave (or appliance) away from appliances, such as your TV or radio.

# appendix

## SPECIFICATIONS

<b>MODEL NUMBER</b>	<b>SMH7185BG / SHM7185WG</b>
Oven Cavity	1.8 cuft
Controls	10 power levels, including defrost
Timer	99 minutes, 99 seconds
Power Source	120 VAC, 60 Hz
Power Consumption	1650 Watts
Power Output	1100 Watts
Oven Cavity Dimensions	21 <sup>13</sup> / <sub>32</sub> "(W) X 10 <sup>9</sup> / <sub>32</sub> "(H) X 14 <sup>17</sup> / <sub>32</sub> "(D)
Outside Dimensions	29 <sup>7</sup> / <sub>8</sub> "(W) X 16 <sup>1</sup> / <sub>2</sub> "(H) X 15 <sup>15</sup> / <sub>32</sub> "(D)
Shipping Dimensions	33 <sup>3</sup> / <sub>8</sub> "(W) X 19 <sup>15</sup> / <sub>16</sub> "(H) X 19 <sup>13</sup> / <sub>32</sub> "(D)
Net/Shipping Weight	50.56/61.12 lbs

<b>MODEL NUMBER</b>	<b>SMH7185STG / SMH7187STG</b>
Oven Cavity	1.8 cuft
Controls	10 power levels, including defrost
Timer	99 minutes, 99 seconds
Power Source	120 VAC, 60 Hz
Power Consumption	1650 Watts
Power Output	1100 Watts
Oven Cavity Dimensions	21 <sup>13</sup> / <sub>32</sub> "(W) X 10 <sup>9</sup> / <sub>32</sub> "(H) X 14 <sup>17</sup> / <sub>32</sub> "(D)
Outside Dimensions	29 <sup>7</sup> / <sub>8</sub> "(W) X 16 <sup>1</sup> / <sub>2</sub> "(H) X 15 <sup>15</sup> / <sub>32</sub> "(D)
Shipping Dimensions	33 <sup>3</sup> / <sub>8</sub> "(W) X 19 <sup>15</sup> / <sub>16</sub> "(H) X 19 <sup>13</sup> / <sub>32</sub> "(D)
Net/Shipping Weight	51.6/62.7 lbs



# warranty

---

## **SAMSUNG OVER-THE-RANGE(OTR) MICROWAVE OVEN**

---

### **Limited warranty to original purchaser**

This SAMSUNG brand product, as supplied and distributed by Samsung Electronics America, Inc. (SAMSUNG) and delivered new, in the original carton to the original consumer purchaser, is warranted by SAMSUNG against manufacturing defects in materials and workmanship for a limited warranty period of:

### **ONE (1) YEAR PARTS AND LABOR, TEN (10) YEARS PARTS WARRANTY FOR MAGNETRON**

This limited warranty begins on the original date of purchase, and is valid only on products purchased and used in the United States. To receive warranty service, the purchaser must contact SAMSUNG for problem determination and service procedures. Warranty service can only be performed by a SAMSUNG authorized service center. The original dated bill of sale must be presented upon request as proof of purchase to SAMSUNG or SAMSUNG's authorized service center.

SAMSUNG will repair or replace this product, at our option and at no charge as stipulated herein, with new or reconditioned parts or products if found to be defective during the limited warranty period specified above. All replaced parts and products become the property of SAMSUNG and must be returned to SAMSUNG. Replacement parts and products assume the remaining original warranty, or ninety (90) days, whichever is longer.

In-home service will be provided during the warranty labor period subject to availability within the contiguous United States. In-home service is not available in all areas. To receive in-home service, the product must be unobstructed and accessible to service personnel. If during in-home service repair can not be completed, it may be necessary to remove, repair and return the product. If in-home service is unavailable, SAMSUNG may elect, at our option, to provide for transportation of our choice to and from a SAMSUNG authorized service center. Otherwise, transportation to and from the SAMSUNG authorized service center is the responsibility of the purchaser.

This limited warranty covers manufacturing defects in materials and workmanship encountered in normal, noncommercial use of this product and shall not apply to the following, including, but not limited to: damage which occurs in shipment; delivery and installation; applications and uses for which this product was not intended; altered product or serial numbers; cosmetic damage or exterior finish; accidents, abuse, neglect, fire, water, lightning or other acts of nature; use of products, equipment, systems, utilities, services, parts, supplies, accessories, applications, installations, repairs, external wiring or connectors not supplied or authorized by SAMSUNG which damage this product or result in service problems; incorrect electrical line voltage, fluctuations and surges; customer adjustments and failure to follow operating instructions, cleaning, maintenance and environmental instructions that are covered and prescribed in the instruction book; problems caused by pest infestations, and overheating or overcooking by user; glass tray or turntable; reduced magnetron power output related to normal aging. SAMSUNG does not warrant uninterrupted or error-free operation of the product.

THERE ARE NO EXPRESS WARRANTIES OTHER THAN THOSE LISTED AND DESCRIBED ABOVE, AND NO WARRANTIES WHETHER EXPRESS OR IMPLIED, INCLUDING, BUT NOT LIMITED TO, ANY IMPLIED WARRANTIES OF MERCHANTABILITY OR FITNESS FOR A PARTICULAR PURPOSE, SHALL APPLY AFTER THE EXPRESS WARRANTY PERIODS STATED ABOVE, AND NO OTHER EXPRESS WARRANTY OR GUARANTY GIVEN BY ANY PERSON, FIRM OR CORPORATION WITH RESPECT TO THIS PRODUCT SHALL BE BINDING ON SAMSUNG. SAMSUNG SHALL NOT BE LIABLE FOR LOSS OF REVENUE OR PROFITS, FAILURE TO REALIZE SAVINGS OR OTHER BENEFITS, OR ANY OTHER SPECIAL, INCIDENTAL OR CONSEQUENTIAL DAMAGES CAUSED BY THE USE, MISUSE OR INABILITY TO USE THIS PRODUCT, REGARDLESS OF THE LEGAL THEORY ON WHICH THE CLAIM IS BASED, AND EVEN IF SAMSUNG HAS BEEN ADVISED OF THE POSSIBILITY OF SUCH DAMAGES. NOR SHALL RECOVERY OF ANY KIND AGAINST SAMSUNG BE GREATER IN AMOUNT THAN THE PURCHASE PRICE OF THE PRODUCT SOLD BY SAMSUNG AND CAUSING THE ALLEGED DAMAGE. WITHOUT LIMITING THE FOREGOING, PURCHASER ASSUMES ALL RISK AND LIABILITY FOR LOSS, DAMAGE OR INJURY TO PURCHASER AND PURCHASER'S PROPERTY AND TO OTHERS AND THEIR PROPERTY ARISING OUT OF THE USE, MISUSE OR INABILITY TO USE THIS PRODUCT SOLD BY SAMSUNG NOT CAUSED DIRECTLY BY THE NEGLIGENCE OF SAMSUNG. THIS LIMITED WARRANTY SHALL NOT EXTEND TO ANYONE OTHER THAN THE ORIGINAL PURCHASER OF THIS PRODUCT, IS NONTRANSFERABLE AND STATES YOUR EXCLUSIVE REMEDY.

Some states do not allow limitations on how long an implied warranty lasts, or the exclusion or limitation of incidental or consequential damages, so the above limitations or exclusions may not apply to you. This warranty gives you specific legal rights, and you may also have other rights which vary from state to state.

To obtain warranty service, please contact SAMSUNG at:

**1-800-SAMSUNG (7267864) and [www.samsung.com](http://www.samsung.com)**

memo

---

memo

---



QUESTIONS OR COMMENTS

COUNTRY	CALL	OR VISIT US ONLINE AT
USA	1-800-SAMSUNG(726-7864)	<a href="http://www.samsung.com/us">www.samsung.com/us</a>

Code No.: DE68-00356W-01