

INSTALLATION/USE INSTRUCTIONS

FOOD WASTE DISPOSER

VIKING RANGE CORPORATION
111 Front Street
Greenwood, Mississippi 38930 USA
(662) 455-1200

TOOLS AND MATERIALS YOU WILL NEED:

Slotted Screwdriver, Adjustable Pliers, Plumber's compound, Electrical Tape



TOOLS AND MATERIALS YOU MAY NEED:

Phillips Screwdriver, Drain Auger, Hammer, Hacksaw, Pipe Wrench, 3/8 inch Electrical Clamp Connector, Wire Nuts (2), Second 1 1/2 inch Drain Trap, Water Hose Clamp, Copper Ground Wire, Dishwasher Drain Connection Kit, Air Gap, Electrical On/Off Switch, Drain Tube Extension

Read through the complete instructions before installing the disposer. Determine which of the tools and materials you will need before you begin. Make sure you have all necessary disposer parts before installing the disposer (see part identification diagram below).

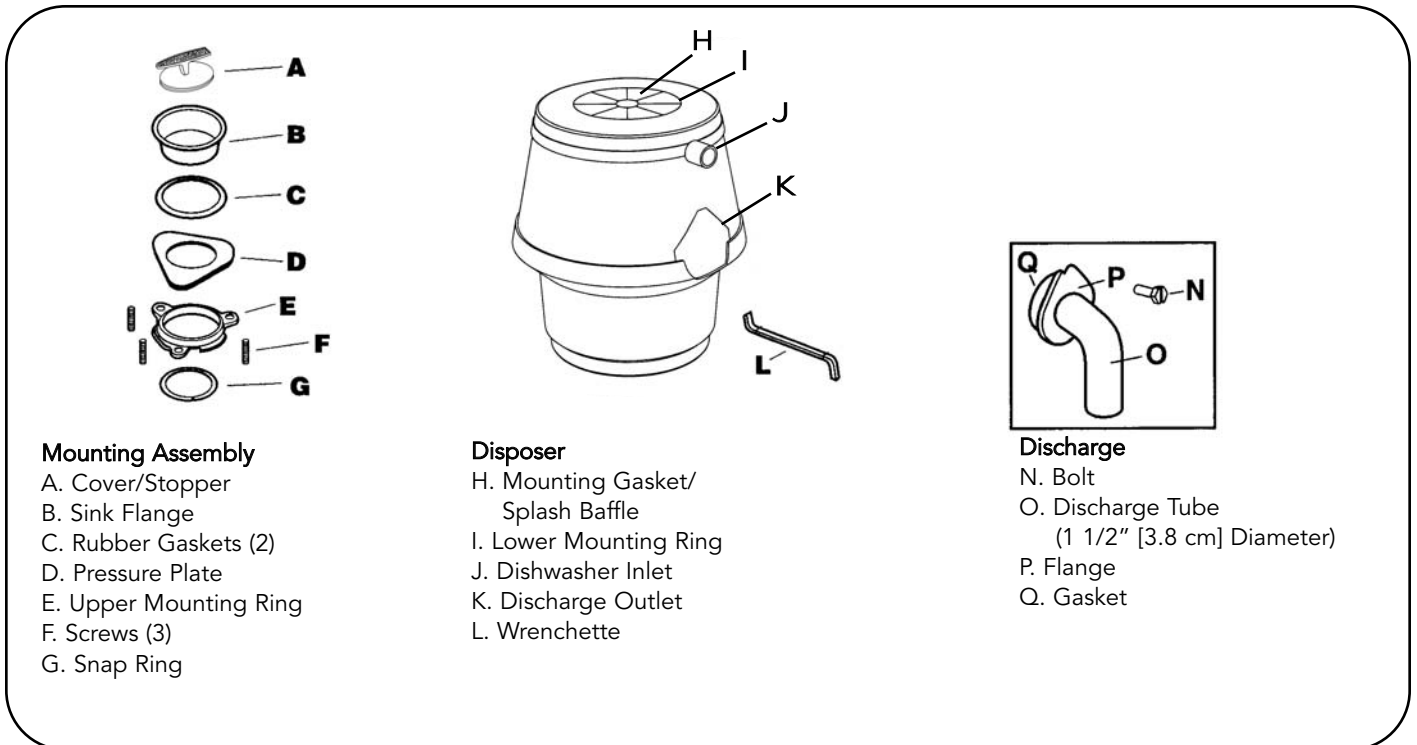

SAFETY SYMBOLS

CAUTION

Caution indicates a potentially hazardous situation which, if not avoided, may result in minor or moderate injury.

WARNING

Warning indicates a potentially hazardous situation which, if not avoided, could result in death or serious injury.

INSTALLATION INSTRUCTIONS

1 CHECK INSTALLATION DIMENSIONS

- A: Disposer height
- B: Distance from bottom of sink bowl to centerline of discharge outlet. (Add 1/2 inch [1.3cm] when stainless steel sink is used.)
- C: Distance from centerline of the discharge outlet to end of discharge tube.
- D: Disposer width
- E: Distance from disposer vertical centerline to centerline of P-trap connection.
- F: Centerline of disposer discharge to centerline at waste pipe entering wall. (Dimension "F" must be greater than 1/4 inch [0.6 cm] to prevent standing water in disposer.)

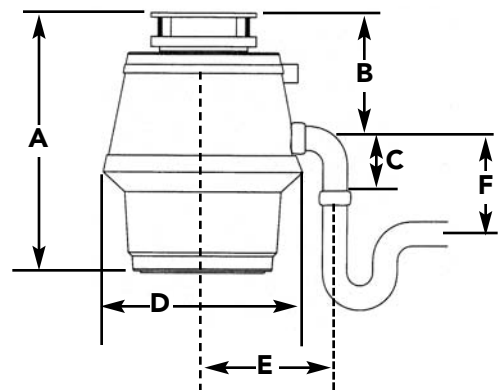

If replacing an existing disposer, skip ahead to Instruction 6. If this is a first time installation, continue with **Instruction 2**.

Dimension	A	B	C	D	E
	13 11/16" (34.8 cm)	6 13/16" (17.3 cm)	4" (10.2 cm)	10 1/16" (25.6 cm)	5 3/4" (14.6 cm)

2 DISCONNECT SINK DRAIN

1. Loosen nut (A) at top of "P-trap" with pipe wrench (see Figure 2-1).
2. Loosen nut (B) at top of extension pipe. Remove extension pipe.
3. Loosen nut (C) at base of sink flange. (If nut is corroded or too tight, apply penetrating lubricant.)
4. Push sink flange up through sink hole and remove it (see Figure 2-2).
5. Clean sink flange area of any putty or other material.

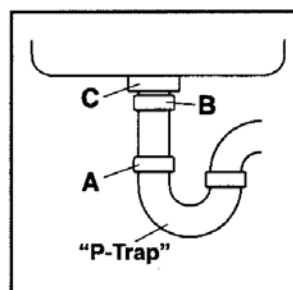

2-1



2-2

3 DISASSEMBLE NEW DISPOSER - MOUNTING ASSEMBLY

1. Insert wrenchette (or screwdriver) into one mounting lug and hold lower mounting ring securely with one hand (see Figure 3-1). With your other hand, turn mounting assembly counterclockwise to remove mounting assembly from lower mounting ring.
2. Turn mounting assembly over (see Figure 3-2) and loosen three mounting screws (A) until you can access snap ring (B).
3. Use screwdriver to pry snap ring off of sink flange. Mounting assembly will now come apart.

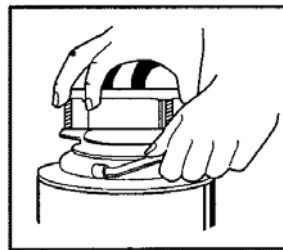

3-1

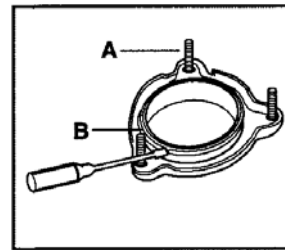

3-2

4 INSTALL FLANGE IN SINK HOLE

Slip one rubber gasket onto sink flange and insert sink flange through sink hole. NOTE: Rubber gasket is preferred sink seal. If sink opening does not permit use of rubber seal, follow steps below to install flange with plumber's compound.

1. Roll 1/4 pound (4 oz. [113g]) of non-hardening plumber's compound to make 3/4 inch (1.9 cm) thick rope to seal around sink flange.
2. Apply putty evenly around sink hole (see Figure 4-1).
3. Press sink flange slowly but firmly into sink drain hole to seat evenly on putty (see Figure 4-2). Use screwdriver or putty knife to scrape all putty from edge of sink hole.

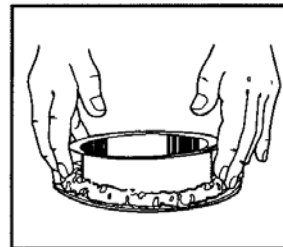

4-1

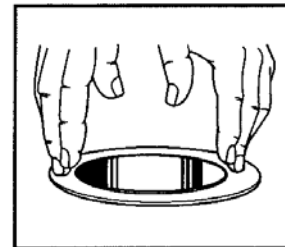

4-2



CAUTION

Do not use plumber's compound on any other disposer connection; it may harm disposer and cause property damage.

5 ATTACH UPPER MOUNTING ASSEMBLY TO SINK FLANGE

You may wish to place a weighted object in the sink to hold the sink flange in place. (Place a towel under object in sink to prevent scratching.) Reference Figure 5-1 for part identification.

1. Working from under sink, slip rubber gasket and pressure plate over sink flange.
2. Holding rubber gasket and backup ring in place, slip upper mounting ring over sink flange so it seats against pressure plate.
3. With rubber gasket, pressure plate, and upper mounting ring tight to sink bottom, slide snap ring onto sink flange until it pops into groove on flange*.
4. Tighten three mounting screws up to sink until mounting assembly is seated tightly and evenly against sink.

*Placing a thick, wide rubber band around the sink flange (above the snap ring groove) may help hold parts in place while installing snap ring. (Remember to remove rubber band after snap ring is installed.)

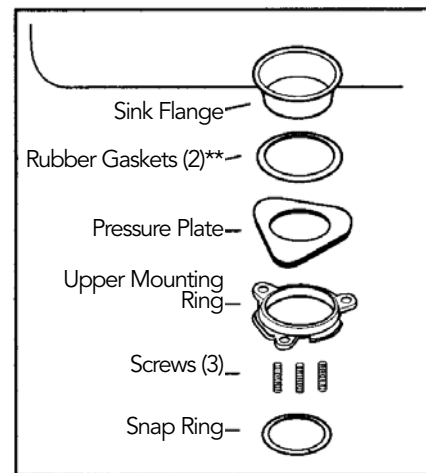

5-1

**NOTE: One rubber gasket is on sink flange above the sink and one is on the sink flange under the sink.

If replacing an existing disposer, go to Instruction 6. If this is a first time installation, skip ahead to Instruction 7.

6 REMOVE EXISTING DISPOSER



WARNING

Electric Shock



- Turn off electrical power at fuse box or circuit breaker before removing electrical cover plate.
- Disposer must be grounded. Improper connection can result in electric shock.



CAUTION

- Do not position your head or body under disposer; unit could fall during removal or installation.

1. Turn off electrical power at fuse box or circuit breaker.
2. Disconnect drain trap from disposer waste discharge tube with adjustable pliers (see Fig. 6-1). (Disconnect dishwasher drain connection, if required.)
3. Support disposer with one hand and insert end of wrenchette or screwdriver into right side of one mounting lug on lower mounting ring (see Figure 6-2). Lift disposer slightly and loosen lower mounting ring by pushing or pulling wrenchette or screwdriver to left until disposer is free from mounting assembly. (Disposer may be heavy - provide support.)
4. With electrical supply turned off, turn disposer upside down and remove electrical cover plate (see Figure 6-3). Loosen green ground screw and remove wire nuts (see Figure 6-4). Disconnect disposer wires from electrical supply wires. Loosen screw(s) on electrical clamp connector and remove wires from disposer.

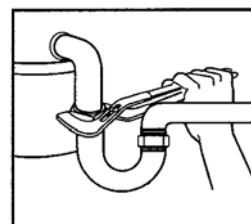

6-1

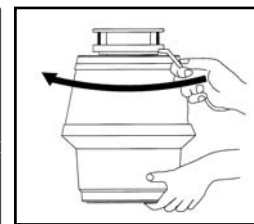

6-2

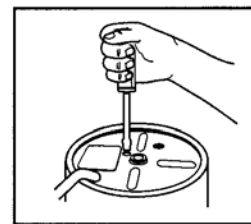

6-3

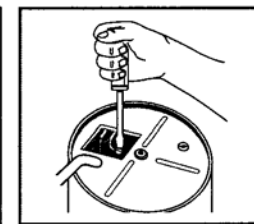

6-4

- If the new disposer mounting is the same as old one, remove mounting assembly from disposer (Instruction 3) and go to **Instruction 7**.
- If the new disposer mounting is different from the old one (or you wish to replace the old sink flange) you must complete Steps 5 - 6 (below), and Instructions 2 - 5, then continue with **Instruction 7**.

5. Loosen three mounting screws, pry snap ring off with screwdriver, and remove old mounting assembly (see Figure 6-5). (Some mounting assembly removal requires additional tools.)
6. Push old sink flange up through sink hole (see Figure 6-6). Use screwdriver or putty knife to scrape all old compound and other material from edge of sink hole.

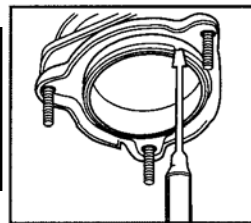

6-5

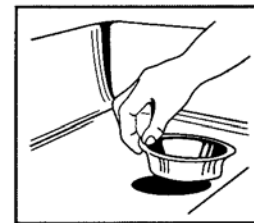

6-6

7 CLEAN SINK DRAIN LINE

Failure to clean sink drain line may result in drain line blockage.

1. Remove P-trap.
2. With drain auger, clear all hardened waste material in horizontal drain line.

If you are not connecting a dishwasher to disposer, go to **Instruction 9**.

8 PREPARE DISHWASHER DRAIN CONNECTION (IF APPLICABLE)

The knockout drain plug should only be removed if you are connecting a built-in dishwasher to the disposer. NOTE: If the dishwasher connection is made without removing the plug, the dishwasher may overflow. (Connections must comply with local plumbing codes.)

Remove Knockout Plug

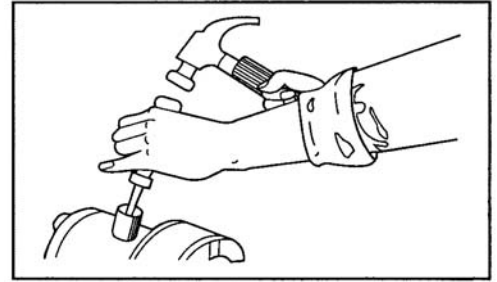

1. Lay disposer on its side and insert screwdriver into dishwasher inlet so tip rests on outer edge of knockout plug.
2. Tap end of screwdriver handle with hammer until molded plug breaks loose (see Figure 8-1).
3. REMOVE LOOSE KNOCKOUT PLUG FROM INSIDE DISPOSER.



Attach Dishwasher Drain Connector

If your dishwasher drain hose is 7/8 inch (2.2 cm) ID diameter, go to Instruction 9. If your dishwasher drain hose is not 7/8 inch (2.2 cm) ID diameter, you must attach a dishwasher drain connector to the dishwasher drain inlet. Follow the installation instructions with the connection kit. (You will connect the dishwasher drain hose to the connector in **Instruction 12**.)

9 CONNECT DISPOSER TO ELECTRICAL SUPPLY

 WARNING	
	Electric Shock
	<ul style="list-style-type: none">• Disconnect electrical power at fuse box or circuit breaker before installing or servicing disposer. Failure to do so can result in death or electrical shock.

Disposer Circuit Requirements

Ensure the following electrical requirements are met before connecting disposer to switch (see Figure 9-1 for typical direct wired electrical circuit diagram):



- Remove fuse (or open the circuit breaker) before connecting disposer to circuit.
- If junction box is used, connect the junction box to the switch on a separate 15 Amp, 120 Volt AC circuit with the appropriate cable. (Use 14 gauge wire with 15 Amp circuit).
- If you install a double receptacle to handle other small kitchen appliances, include a wall switch in disposer receptacle circuit and wire other receptacle directly to power source.
- This disposer requires a switch with a marked "Off" position (wired to disconnect all ungrounded supply conductors) installed within sight of the disposer sink opening (1 HP minimum rating).

Connect Disposer to Electrical Supply/Ground Disposer

Follow these instructions to direct wire the disposer.

1. Remove electrical cover plate from bottom of disposer and pull out black and white wires (see Figure 9-1). DO NOT REMOVE CARDBOARD INSULATION SHIELD.
2. Run electrical cable through access hole (A) on bottom of disposer (with 1/2 inch [1.3 cm] conduit or 3/8 inch [0.9 cm] flex) and secure with clamp connector.
3. Strip wires back approximately 1/2 inch (1.3 cm). Connect white (neutral) electrical wire to white disposer wire, and black (hot) electrical wire to black disposer wire (may have colored stripe) with wire nuts (see Figure 9-1). Insulate wire connections with electrical tape, and push connections into disposer housing without displacing cardboard insulation shield. Do not reinstall electrical plate until disposer is properly grounded.

Once the circuit you are using is grounded at the service panel, attach the ground wire to the green ground screw (B) in the electrical cover plate opening and secure the electrical plate (C) (see Figure 9-1).

 WARNING	
	Electric Shock
	<ul style="list-style-type: none">• Disconnect electrical power at fuse box or circuit breaker before installing or servicing disposer. Failure to do so can result in death or electrical shock.

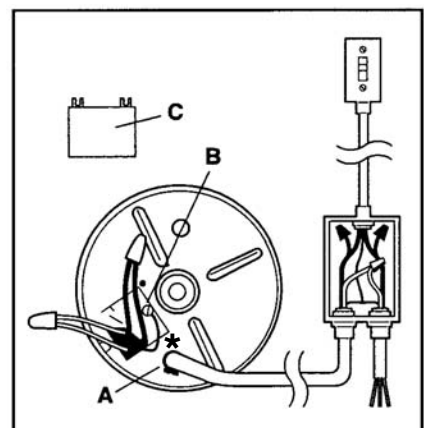

*Install a standard wire clamp (not supplied) into the opening on the bottom of the disposer

Grounding Instructions

This appliance must be connected to a grounded, metal, permanent wiring system; or an equipment-grounding conductor must be run with the circuit conductors and connected to the equipment-grounding terminal or lead on the appliance.

10 CONNECT DISPOSER TO MOUNTING ASSEMBLY

Clear any objects from inside the disposer grind chamber before mounting the disposer.

CAUTION

Personal Injury

Do not position your head or body under disposer; unit could fall during installation.

1. Position disposer with three mounting tabs (A) aligned in position to slide over mounting tracks (B) (see Figure 10-1).
2. Lift disposer, insert top end (mounting gasket) into mounting assembly, and turn lower mounting ring to right (with wrenchette or screwdriver) until mounting tabs lock over ridges (C) on mounting ring tracks (see Figure 10-2). (MAKE SURE ALL THREE MOUNTING TABS ARE LOCKED OVER RIDGES.) Disposer will now hang by itself.

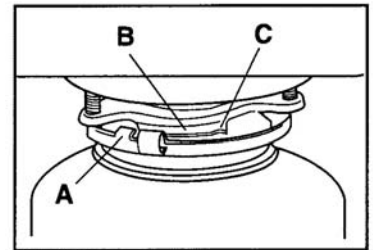

10-1

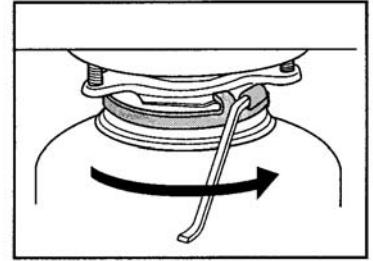

10-2

11 ATTACH DISCHARGE TUBE TO WASTE DRAIN

CAUTION

Property Damage

Do not use thread sealants or pipe dope; they may harm the disposer and cause property damage.

One-Bolt Discharge Tube Installation

1. Slide metal flange (A) over discharge tube (B) (see Figure 11-1).
2. Rubber gasket (C) must be installed on top end of discharge tube. Secure metal flange and Discharge tube to disposer with bolt (D).
3. Rotate disposer so that discharge tube is aligned with drain trap. (To prevent leaks, do not pull or bend discharge tube to drain trap.) If discharge tube is too long, cut off as much of tube as necessary with hacksaw (make sure cut is straight and clean.) If discharge tube is too short, you can purchase an extension from a hardware store. (Disposer must remain in vertical position to prevent vibration.)
4. Place P-trap nut, then beveled washer (not supplied) on bottom of discharge tube and tighten on drain trap. (If you have a double sink, use separate drain traps for both sides.)
5. Ensure lower mounting ring is securely locked over mounting flange ridges.

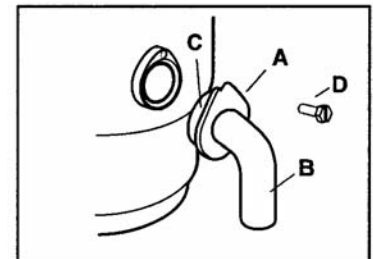

11-1

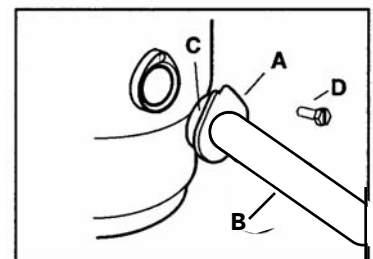

11-2

Although the supplied discharge tube is preferred, a straight discharge may be used. Slide metal flange over straight discharge tube (not supplied), install rubber gasket onto discharge tube, and secure metal flange and straight discharge tube to disposer with one bolt (see Figure 11-2).

12 CONNECT DISHWASHER DRAIN (IF APPLICABLE)

In some areas, codes require that the dishwasher be connected to the disposer through an air gap (A). (See Figure 12-1) (An air gap prevents waste water backflow and/or dishwasher contamination.) Ensure knockout plug is removed (see **Instruction 8**). Plumbing connections must comply with local plumbing codes.

- If you have a 7/8 inch (2.2 cm) ID diameter dishwasher drain hose, use a hose clamp to attach the drain hose to the dishwasher inlet. (Verify that hose you are using is rated for dishwasher use.)
- If you have already attached a dishwasher drain connector to your dishwasher drain hose (for drain hose other than 7/8 inch [2.2 cm] ID diameter), use a hose clamp to attach the drain hose/connector to the dishwasher inlet on the disposer.

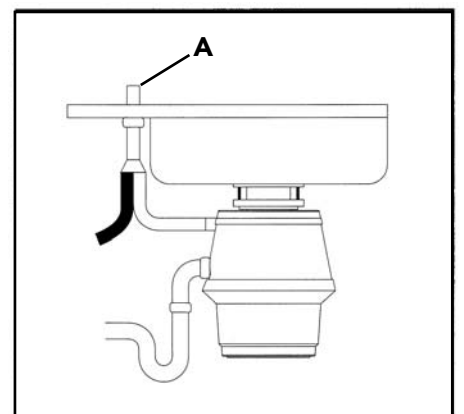

Figure12-1

The disposer installation is complete. Using the stopper, fill the sink with water. Remove the stopper, turn disposer on, and check under sink for leaks. Read ALL SAFETY INSTRUCTIONS before operating the disposer.



WARNING

INSTRUCTIONS PERTAINING TO RISK OF FIRE, ELECTRICAL SHOCK, OR INJURY TO PERSONS (SAVE THESE INSTRUCTIONS)

When using electric appliances, basic precautions are always to be followed, including:

- Read all instructions before using the disposer.
- To reduce the risk of injury, close supervision is required when an appliance is used near children.
- Do not put fingers or hands into a waste disposer.
- Turn the power switch to the off position before attempting to clear a jam or remove an object from the disposer.
- When attempting to loosen a jam in a waste disposer, use the Jami-nator Button (model 1000) or the self-service wrenchette as described below.
- When attempting to remove objects from a waste disposer, use long-handled tongs or pliers.
- To reduce the risk of injury by materials that are expellable by a waste disposer, do not put the following into a disposer:
 - a) Clam or oyster shells
 - b) Caustic drain cleaners or similar products
 - c) Glass, china, or plastic
 - d) Large (whole) bones
 - e) Metal (such as bottle caps, tin cans, or utensils)
 - f) Hot grease or other hot liquids.
- When not operating the disposer, leave the drain cover in place to reduce the risk of objects falling into the disposer.
- This product is designed to dispose of normal household food waste; inserting materials other than food waste into disposer is not recommended. To reduce the risk of injury, do not use the sink containing the disposer for purposes other than food preparation (such as baby bathing or washing hair).
- Do not dispose of the following in the disposer: paints, solvents, household cleaners and chemicals, automotive fluids, or gasoline.
- Replace anti-splash baffle when worn to help prevent entry or ejection of material and splashing water.
- Before pressing reset button, attempting to clear jam, or removing objects from inside disposer, make sure disposer power switch is turned off.
- FIRE HAZARD:** Do not store flammable items such as rags, paper, or aerosol cans near disposer.
- Do not store or use gasoline or other flammable vapors and liquids in vicinity of disposer.

OPERATING INSTRUCTIONS

CONTINUOUS FEED MODELS

Continuous feed disposers have a one-piece cover/stopper that acts only as a seal. A wall switch is used to turn the disposer on or off. To SEAL the cover for holding water in the sink, press the cover firmly in the disposer opening. **CAUTION:** Do not operate the disposer with the cover in the SEAL position.

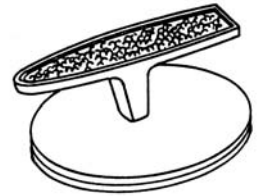

To Operate Disposer:

1. Remove the cover from sink opening and turn on a good flow of COLD water. (Cold water hardens greasy substances, making it easy to grind them into tiny particles. Unlike hot water, cold water keeps grease from sticking to the drain lines.) It is important and absolutely necessary that cold water flows into the disposer while it is in operation. **NEVER USE HOT WATER.** If you have a double sink, make sure the faucet points to the side where the disposer is installed.
2. Turn the wall switch to "ON" position.
3. Scrape food waste into disposer opening. The splash guard will reduce splashing. Mix soft and hard food waste items for most efficient grinding.
4. Allow both the disposer and cold water to run for about 30 seconds after grinding action is completed. This will assure that any bone slivers or other hard objects that could cause jams are flushed from the grind chamber. This will also assure proper flushing of the external drain line.
5. Turn the wall switch to "OFF" position.

WHAT CAN BE PUT IN YOUR DISPOSER

Your disposer is designed to dispose of food wastes including bones, fruit and vegetable wastes, pits, egg shells, and coffee grounds. Large pieces of food waste like melon rinds should be cut into smaller pieces before being put into the disposer. **Do not put items like glass, china, metal, tin cans, bottle caps, or oyster and clam shells into the disposer. These items belong in the trash. Damage may result to both disposer and drain system if this type of trash is placed in disposer.**

DO...

- First turn on a moderate to strong flow of **COLD WATER** and then turn on the disposer. Continue running cold water for 15 seconds after grinding is completed to flush the drain line.
- Grind hard materials such as small bones, fruit pits, and ice. A scouring action is created by the particles inside the grind chamber.
- Grind peelings from citrus fruits to freshen up drain smells.
- Grind extremely fibrous materials like corn husks, artichokes, etc.
- Use a disposer cleaner, degreaser, or deodorizer as necessary to relieve objectionable odors caused by grease buildup.

DON'T...

- Don't pour grease or fat down your disposer or any drain. It can build up in pipes and cause drain blockages. Put grease in a jar or can and dispose in the trash.
- Don't use **HOT WATER** when grinding food waste. It is OK to drain hot water into the disposer between grinding periods.
- Don't fill disposer with a lot of vegetable peels all at once. Instead, turn the water and disposer on first and then feed the peels in gradually.
- Don't turn off disposer until grinding is completed and only sound of motor and water is heard.
- Don't be alarmed if a brown discoloration appears on the face of the grind wheel. This is normal. It is surface discoloration only and will not affect the life or performance of the disposer.

SEPTIC TANKS AND DISPOSERS

Food waste disposers can definitely be used with septic tanks. In fact, 20% of all disposers in use discharge their ground waste into a septic tank. Food wastes from a disposer are actually beneficial to the bacterial action which occurs in a septic tank. There are, however, some items which are normally ground in a disposer which **should not** be if connected to a septic tank. These inorganic materials, which are not bacteria digestible, are shells from eggs, shrimp, crabs, lobsters, or the like. Clam and oyster shells should not be ground in any disposer. Putting those items through a disposer will cause the tank to fill quicker and require cleaning more often.

Recommended guidelines to accommodate all home usage including water bearing appliances like, clothes washers, dishwashers, and disposers are:

<u>Number of People in House</u>	<u>Recommended Tank Capacity</u>
2 to 3	750 gallons
4 to 5	1000 gallons
6 or more	1500 gallons

In most cases, if there are no current septic tank problems, the addition of a disposer will not cause any problems. Many consider the installation of a disposer like adding a new member to the family as it simply causes the tank to be cleaned about 10% more often - every 6 to 7 years instead of every 7 to 8 years.

The best disposer for a septic tank is one which grinds the food into fine particles and adds as little water as possible. The VIKING grind system is super fast and extremely efficient and is especially well suited to installation with a septic tank.

 CAUTION
Regularly inspect disposer and plumbing fittings for water leaks, as water leaks can cause property damage. Manufacturer cannot be held responsible for property damage as a result of water leaks.

USER - MAINTENANCE INSTRUCTIONS

CLEANING DISPOSER

Over time, food particles may accumulate in the grind chamber and baffle. An odor from the disposer is usually a sign of grease and food buildup, caused by insufficient water flow during and after disposer use. To clean disposer:

1. Turn off disposer and disconnect power supply.
2. Reach through sink opening and clean underside of splash baffle and inside upper lip of grind chamber with scouring pad.
3. Place stopper in sink opening and fill sink halfway with warm water.
4. Mix 1/4 cup (.06 L) baking soda with water. Turn disposer on and remove stopper from sink at same time to wash away loose particles.

WHAT IF YOUR DISPOSER JAMS

Jams of any nature are not considered a product deficiency and are not covered by in-warranty service or labor. Each time the disposer is operated, the grind wheel moves in the opposite direction for greater efficiency and longer grinding element life. Should the disposer become jammed, the reversing action will help clear many jams.

If your disposer appears to be jammed, the grind wheel inside the upper housing will not turn freely. Check the following procedure for each model before calling your dealer and possibly save the cost of a service call. **Note:** These disposers are equipped with built-in overload protection. If disposer is jammed for more than 30 seconds, an overload protector automatically cuts off current to the motor, preventing motor damage. See below for instructions on how to reset.

Procedure for releasing jam:

1. Each time the disposer is operated, the grind wheel moves in the opposite direction. Should the disposer become jammed, the reversing action will help clear many jams. Flip the wall switch off and on. Repeat several times if necessary to clear the jam.
2. **The exclusive Power Plus Jam-inator™ button**, (only available on 1000 model), uses a solid state control to vibrate the grind wheel back and forth 7000 times per minute. (See Figure B) This will eliminate almost any jam instantly. When a difficult jam occurs, follow these steps:
 - Make sure the wall switch is in the "ON" position and the disposer is "humming".
 - Press the Jam-inator button on the front side of the disposer and release - DO NOT HOLD.
 - If the disposer is still jammed, repeat pressing and releasing the button until the disposer runs.



Figure B

 CAUTION
Personal Injury To prevent personal injury, turn disposer off before attempting to clear jams.

- If the disposer is still jammed, turn off disposer and water. Insert one end of self-service wrenchette into center hole on bottom of disposer (see Figure C). Work wrenchette back and forth until it turns one full revolution. Remove wrenchette.
- Reach into disposer with tongs and remove object(s). Allow disposer motor to cool for 3 - 5 minutes and lightly push red reset button on the disposer bottom (see Figure C). (If motor remains inoperative, check service panel for tripped circuit breakers or blown fuses.)

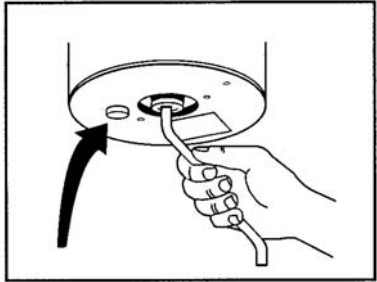

Figure C

If the disposer is jammed too long (approximately 9 seconds), the thermal overload protector will stop the motor (the motor will not hum). Wait 3 to 5 minutes, then press the red reset button on the bottom of the disposer. If disposer has been running for an extended period of time, you may have to wait 20 to 25 minutes for the motor to cool before pressing the red reset button. Lightly push red reset button on bottom of the disposer

Operation With the Dishwasher

If your dishwasher drains through your disposer, run the disposer for a short time before starting the dishwasher. This will ensure that the disposer is free of any food waste. Such waste could cause a "backup" of the discharge water from the dishwasher. **DO NOT OPERATE THE DISPOSER WHILE THE DISHWASHER IS IN OPERATION.** After operating the dishwasher, run the disposer for a short time to clean and flush all particles discharged by the dishwasher into the disposer down the main drain line.

When the dishwasher is in operation, we recommend the cover be placed in the DRAIN position. This will eliminate the possibility of water splash out.

Use Energy Wisely

A food waste disposer uses a negligible amount of energy. Total energy requirements associated with operating a food waste disposer will be minimized by following the recommendations in this manual.

SERVICE INFORMATION

- If your disposer should fail to operate:
- Is the grind wheel jammed? Make sure grind wheel is free to rotate.
 - Is the circuit breaker open, or is fuse blown?
 - Is the disposer wall switch turned "ON"?

- If Service is Required:
- Call your dealer or authorized service agency. The name of the authorized service agency can be obtained from the dealer or distributor in your area.
 - Have the following information available:
 - Model number
 - Serial number
 - Date purchased
 - Name of dealer from whom you purchased the appliance.
 - Clearly describe the problem you are experiencing.

If you are unable to obtain the name of an authorized service agency, or continue to have service problems, call Viking, (888) 845-4641, or write to:

Viking Preferred Service
 111 Front Street
 Greenwood, Mississippi 38930 USA

Record the information indicated below. You will need it if service is ever required. The serial and model numbers for your disposer are located on an identification plate attached to the side at the bottom of the disposer.

Model Number _____	Serial Number _____
Date Purchased _____	Date Installed _____
Dealer's Name _____	
Address _____	

If service requires installation of parts, use only authorized parts to ensure protection under the warranty.

This manual should remain with the disposer for future reference.

HEAVY DUTY FOOD WASTE DISPOSERS WARRANTY

Heavy duty food waste disposers and all of their component parts, except as detailed below*, are warranted to be free from defective materials or workmanship in normal household use for a period of ten (10) years for Model 1000 or seven (7) years for Model 750 from the date of original retail purchase. Viking Range Corporation, warrantor, agrees to repair or replace, at its option, any part which fails or is found to be defective during the warranty period.

NINETY (90) DAY RESIDENTIAL PLUS WARRANTY This warranty applies to applications where use of the product extends beyond normal residential use. Examples are, but not limited to, bed and breakfasts, fire stations, private clubs, churches, etc. This warranty excludes all commercial locations such as restaurants, food service locations and institutional food service locations.

This warranty extends to the original purchaser of the product warranted hereunder and to each transferee owner of the product during the term of the warranty.

This warranty shall apply to products purchased and located in the United States and Canada. Products must be purchased in the country where service is requested. Warranty labor shall be performed by an authorized Viking Range Corporation service agency or representative. Warranty shall not apply to damage resulting from abuse, accident, natural disaster, loss of electrical power to the product for any reason, alteration, outdoor use, improper installation, improper operation, or repair or service of the product by anyone other than an authorized Viking Range Corporation service agency or representative. This warranty does not apply to commercial usage. Warrantor is not responsible for consequential or incidental damage whether arising out of breach of warranty, breach of contract, or otherwise. Some jurisdictions do not allow the exclusion or limitation of incidental or consequential damages, so the above limitation or exclusion may not apply to you.

Owner shall be responsible for proper installation, providing normal care and maintenance, providing proof of purchase upon request, and making the appliance reasonably accessible for service. If the product or one of its component parts contains a defect or malfunction during the warranty period, after a reasonable number of attempts by the warrantor to remedy the defects or malfunctions, the owner is entitled to either a refund or replacement of the product or its component part or parts. Warrantor's liability on any claim of any kind, with respect to the goods or services covered hereunder, shall in no case exceed the price of the goods or service or part thereof which gives rise to the claim.

WARRANTY SERVICE: Under the terms of this warranty, service must be performed by a factory authorized Viking Range Corporation service agent or representative. Service will be provided during normal business hours, and labor performed at overtime or premium rates shall not be covered by this warranty. To obtain warranty service, contact the dealer from whom the product was purchased, an authorized Viking Range Corporation service agent, or Viking Range Corporation. Provide model and serial number and date of original purchase. For the name of your nearest authorized Viking Range Corporation service agency, call the dealer from whom the product was purchased or Viking Range Corporation. **IMPORTANT:** Retain proof of original purchase to establish warranty period.

The return of the Owner Registration Card is not a condition of warranty coverage. You should, however, return the Owner Registration Card so that Viking Range Corporation can contact you should any question of safety arise which could affect you. This warranty gives you specific legal rights, and you may also have other rights which may vary from jurisdiction to jurisdiction.

VIKING RANGE CORPORATION
111 Front Street
Greenwood, Mississippi 38930 USA • (662) 455-1200