



**ENGLISH**

# **USE AND CARE GUIDE**

## **MODEL WCAM 1812 COMBINATION WASHER/DRYER**

**IMPORTANT!**  
To get the best performance from your  
appliance, read all operating instructions  
before using it for the first time.

**FRANÇAIS**

*READ AND SAVE THESE INSTRUCTIONS FOR FUTURE REFERENCE*

---

**ESPAÑOL**

# CONTENTS

IMPORTANT SAFETY INSTRUCTIONS .....	3
DESCRIPTION OF THE MACHINE .....	4
INSTALLATION INSTRUCTIONS .....	5
RECOMMENDED LOAD SIZES .....	7
CARE LABEL INSTRUCTIONS .....	7
THE CONTROL PANEL .....	8
WASH PROGRAMS .....	9
INSTRUCTIONS FOR USING THE WASHER/DRYER .....	10
CARE AND MAINTENANCE .....	11
COMMON LAUNDRY PROBLEMS .....	12
TROUBLESHOOTING .....	14
WARRANTY .....	15
QUICK START REFERENCE .....	16

## IMPORTANT SAFETY INSTRUCTIONS

### **WARNING!**

**To reduce the risk of fire, electric shock, or injury to persons when using your appliance, follow basic precautions, including the following:**

- ◆ Read all instructions before using the appliance.
- ◆ Do not run appliance while you are out of the home.
- ◆ Do not wash or dry articles that have been previously cleaned in, washed in, soaked in, or spotted with gasoline, dry-cleaning solvents, cooking oils, or other flammable or explosive substances because they give off vapors that could ignite or explode.
- ◆ Do not allow children to play on or in the appliance. Close supervision of children is necessary when the appliance is used near children.
- ◆ Before the appliance is removed from service or discarded, remove the door to the washing compartment.
- ◆ Do not reach into the appliance if the drum is moving.
- ◆ Do not install or store this appliance where it will be exposed to the weather.
- ◆ Do not tamper with controls.
- ◆ Do not repair or replace any part of the appliance or attempt any servicing unless specifically recommended in the user-repair instructions or in published user-repair instructions that you understand and have the skills to carry out.
- ◆ Do not add gasoline, dry-cleaning solvents, or other flammable or explosive substances to the wash water. These substances give off vapors that could ignite or explode.
- ◆ Do not use fabric softeners or products to eliminate static unless recommended by the manufacturer of the fabric softener or product.
- ◆ Do not use fabric softeners or dryer sheets unless the manufacturer gives written assurance that the product will not damage a tumble dryer.
- ◆ Do not heat-dry items containing:
  - vinyl, plastic, foam rubber or similarly textured rubberlike materials
  - fiberglass
  - wool unless the label specifies “washable”
- ◆ Do not place items exposed to cooking oils in your dryer. Items contaminated with cooking oils may contribute to a chemical reaction that could cause a load to catch fire.
- ◆ Do not heat dry items that have been dry-cleaned.
- ◆ Under certain conditions, hydrogen gas may be produced in a hot water system that has not been used for 2 weeks or more. **HYDROGEN GAS IS EXPLOSIVE.** If the hot water system has not been used for such a period, before using a washing machine or combination washer-dryer, turn on all water faucets and let the water flow from each for several minutes. This will release any accumulated hydrogen gas. As the gas is flammable, do not smoke or use an open flame during this time.

### **GROUNDING INSTRUCTIONS**

#### **WARNING!**

**This appliance must be properly grounded.**

#### **Grounding instructions for a grounded, cord-connected appliance**

In the event of malfunction or breakdown, grounding will reduce the risk of electric shock by providing a path of least resistance for electric current. This appliance is equipped with a cord having an equipment-grounding conductor and a grounding plug. The plug must be plugged into an appropriate outlet that is properly installed and grounded in accordance with all local codes and ordinances.

#### **WARNING!**

**Improper connection of the equipment-grounding conductor can result in a risk of electric shock. Check with a qualified electrician or service representative or personnel if you are in doubt as to whether the appliance is properly grounded.**

Do not modify the plug provided with the appliance. If it will not fit the outlet, have a proper outlet installed by a qualified electrician.

**NOTE:** This manual does not cover every possible condition and situation that may occur. Use common sense and caution when installing, operating, and maintaining any appliance.

**SAVE THESE INSTRUCTIONS FOR FUTURE REFERENCE**

## DESCRIPTION OF THE MACHINE

This combination washer and dryer is a domestic appliance capable of washing any type of fabric.

- ◆ The machine is constructed in sheet steel panels with a treated and painted finish that ensures its aesthetic quality remains unaltered over time.
- ◆ The motor and all moving parts have been designed and produced in a manner that guarantees minimum noise levels.
- ◆ The stainless steel drum is large and well mounted to ensure a better quality wash and a longer life of clothing.
- ◆ The control panel lets you use all the wash and dry programs with ease.
- ◆ The access door has a wide opening to facilitate easy loading and unloading of the washing.

1. Door
2. Stainless steel drum and barrel
3. Stove-enamelled power-coat paint
4. Four adjustable rubber-covered feet
5. Emergency drain and lint filter

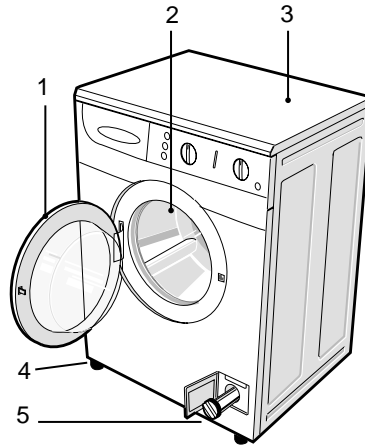

### SPECIFICATIONS:

Supply voltage: Single-phase 115 V, 60 Hz, 15 Amp  
Inlet supply hose: Two 5-ft (1.5 m) fill hoses (hot and cold)  
Supply pressure: 15-142 PSI  
Outlet hose: 5.5 ft (1.7 m) polypropylene hose, 3/4" ID

**CAPACITY:** Extra Large

### DIMENSIONS:

A. Width 23-3/8" 59.37 cm  
B. Depth\* 23-1/8" 58.74 cm  
C. Height 33-1/4" 84.45 cm  
\* Depth w/door open: 38-3/4" (98.43 cm)

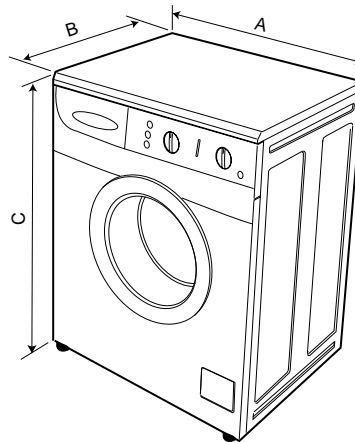

For additional information, see the type plate on the inner door facing.

# INSTALLATION INSTRUCTIONS

Read these instructions carefully and completely before you install the machine. The installation should be carried out by a qualified person who is familiar with all local codes and ordinances for electrical and plumbing connections. Incorrect installation may cause damage and/or injury. If the integrity of the machine is in doubt, do not use it. Call your dealer for qualified assistance.

The machine can be installed anywhere provided that the temperature is not less than 38° F (3° C) and the electrical cords and hoses behind the machine are not cramped.

To install the machine, follow the steps below:

1. Move the machine to its installation position and remove the outer wrapping and the polystyrene base.
2. For transport reasons, the drum is locked in position. Loosen the four locking bolts and remove them along with the plastic spacers (Fig. 1).

**NOTE:** If the plastic spacers cannot be removed from the machine, open the side panel by loosening the screws indicated as "V" in Fig. 1. Remove the spacers and replace the panel.

3. Next, loosen the two locking screws (Z) and remove the two pins (U), as illustrated in Fig. 2. Keep the bolts, screws and pins for future use.
4. Plug the holes with the six plastic plugs packed inside the drum with the documentation (Fig. 3).
5. Level the machine by adjusting the feet by screwing or unscrewing as needed. Once the machine is level, tighten the locknuts (Fig. 4).

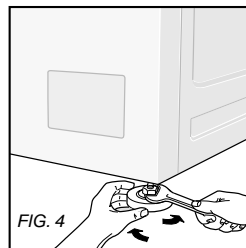
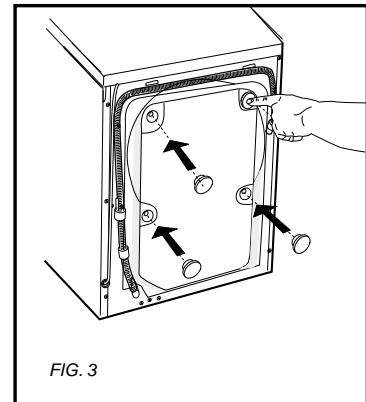
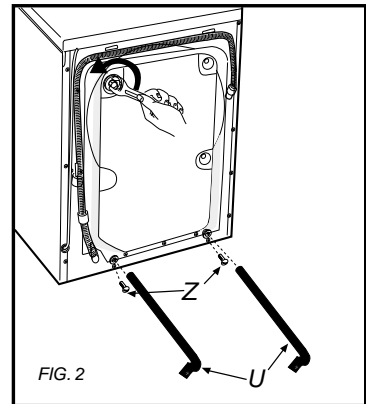
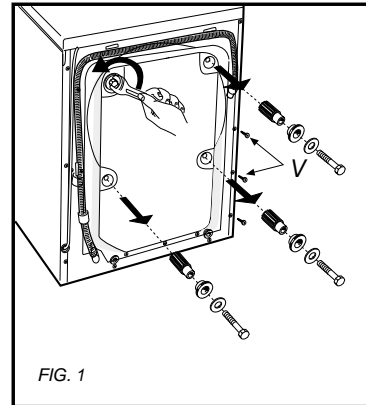

## ELECTRICAL CONNECTION

Check to make sure the main power supply and the outlet are appropriate to support a 110/120 V, 15 amp single-phase circuit. The power supply voltage is indicated on the filter door on the bottom right of the machine.

### Grounding Instructions

This appliance must be grounded. In the case of malfunction or breakdown, grounding will reduce the risk of electric shock by providing a path of least resistance for electric current. This appliance is equipped with a cord having an equipment-grounding conductor and a grounding plug. The plug must be plugged into an appropriate outlet that is properly installed and grounded in accordance with all local codes and ordinances.

#### **WARNING!**

**Improper connection of the equipment-grounding conductor can result in a risk of electric shock. Check with a qualified electrician or serviceman if you are in doubt as to whether the appliance is properly grounded.**

**Do not modify the plug provided with the appliance. If it will not fit the outlet, have a proper outlet installed by a qualified electrician.**

**If the power supply cord is damaged in any way please contact the dealer.**

**Position the appliance so that the plug can be accessed and disconnected easily in case of emergencies.**

## WATER SUPPLY CONNECTION

Before making the water supply connection, allow a quantity of water to flow from the tap. The water should be clean and free from impurities, especially where the system is new or has been left unused for a length of time.

There are two hoses provided with the machine. The hot water hose is indicated with a red stripe running the length of the hose.

Insert the filter (washer) supplied (Fig. 5) before connecting the water inlet hose to the valve. Check that the other end of the hose is tight (Fig. 5A). Turn the supply valve on (Fig. 5B).

The drain outlet should be positioned at a height of between 23" (60 cm) and 35" (90 cm) above the floor (Fig. 6).

**NOTE:** To prevent siphoning, do not seal the drain hose connection into the drain outlet.

If the machine is not connected to a drain outlet, place the drain hose and bracket supplied over the edge of a sink or wash basin and anchor it in place.

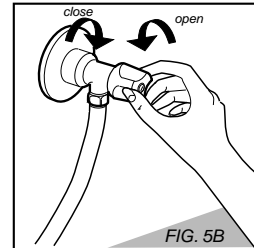
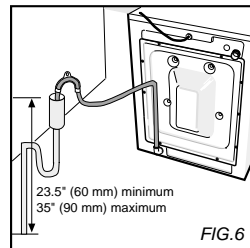
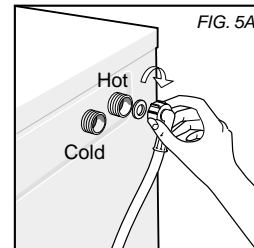
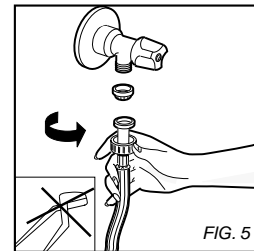

## RECOMMENDED LOAD SIZES

To reduce wrinkling, you should determine the load size based on the type(s) of fabrics being washed.

**Cotton and Linen Fabrics**—These items should be washed in full loads because the tumble action of the tub along with the gentle rubbing, lifting and falling movement of the clothes gives the best cleaning result.







**Permanent Press Fabrics**—These items need more room to move freely during washing for the most wrinkle-free results. Therefore, fill the machine only half full for permanent press items.

**Delicate Fabrics**—These fabrics, such as machine washable wool and silk, should only be washed in one-third size loads for the best results.







## CARE LABEL INSTRUCTIONS

Most clothes and other washable items have permanent care labels. *Read these labels carefully!* Care label instructions and warnings should be followed for the best cleaning results. The table below defines the typical symbols used on fabric care labels. (Note: Some manufacturers may use slightly different symbols.)



### WASH CYCLE

-  Normal wash cycle
-  Permanent Press or Wrinkle Resistant setting
-  Gentle/Delicate setting
-  Hand wash only
-  Do not wash
-  Do not wring. Hang dry, drip dry, or dry flat

### WASH WATER TEMPERATURE

-  Maximum water temp 200 F/95 C
-  Maximum water temp 160 F/70 C
-  Maximum water temp 140 F/60 C
-  Maximum water temp 120 F/50 C
-  Maximum water temp 105 F/40 C
-  Maximum water temp 85 F/30 C





### BLEACH INSTRUCTIONS

-  Any bleach when needed
-  Only non-chlorine bleach
-  Do not bleach





### DRY CLEAN SYMBOL

-  Dry clean only





### TUMBLE DRY CYCLE

-  Machine dry
-  Normal setting
-  Permanent Press or Wrinkle resistant setting
-  Gentle or Delicate setting
-  Do not tumble dry







### TUMBLE DRY HEAT SETTING

-  Any heat
-  High heat
-  Medium heat
-  Low heat
-  No heat/Air fluff

### SPECIAL DRYING INSTRUCTIONS

-  Line dry or hang to dry
-  Drip dry (do not spin or wring)
-  Dry flat
-  Dry in shade

### IRONING INSTRUCTIONS

-  Ironing is necessary
-  High temperature setting
-  Medium temperature setting
-  Low temperature setting
-  Do not iron or press with heat
-  Iron without steam

# THE CONTROL PANEL

The control panel is simple to understand and easy to operate. The illustration below defines the knobs and buttons and the following paragraphs define the purpose of each.

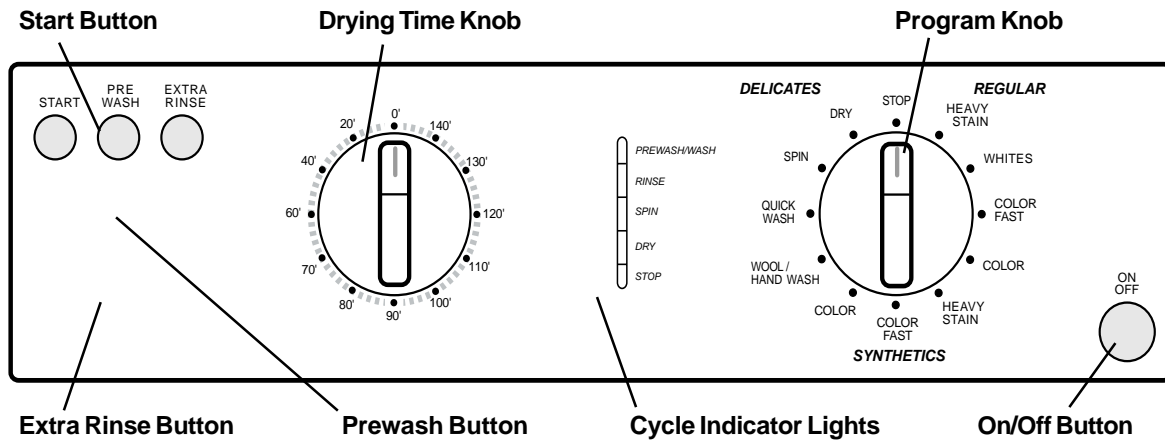

## ON/OFF BUTTON

This button switches the power to the machine on and off. The button will glow to indicate the power is on and the Start button will flash.

## PROGRAM KNOB

Turn this knob to the desired program. The table on page 9 defines each program in detail, so you can determine which program is best for each type of load.

### Stop Position

Leave the Program Knob on Stop if you wish to use the drying function only. To stop the machine after you have started a program, turn the Program Knob to the Stop position.

If you turn the Program to Stop to interrupt a program to add an item or to cancel a program, there will be a two-minute delay before the door lock will release and you can open the door. To restart the machine, you will have to reposition the Program Knob and press the Start Button.

**NOTE:** Before the program will start, the machine will drain any water already in the machine. Before you press Start, it is a good idea to make sure you do not need to add more detergent.

## CYCLE INDICATOR LIGHTS

As the program progresses, the light for the cycle in progress will glow. The Stop indicator light glows when the program is complete. At this point, there will be a two-minute delay before the door lock will release and you can open the door.

## DRYING TIME KNOB

The Drying Time Knob lets you select the number of minutes you wish to dry the load. It is a good idea to start with a shorter time then add time if the load isn't yet dry. This will prevent you from overdrying the load and possibly damaging some garments.

You can also use the drying function only. Simply leave the Program Knob in the Stop position and set the Drying Time Knob to the desired number of minutes, and press Start.

## PREWASH BUTTON

Press this button to select a prewash. This is recommended only for heavily soiled items. The button will glow when this option is on. If you use a prewash, be sure to put detergent in the prewash compartment of the detergent drawer.

**NOTE:** The prewash cannot be selected for the Delicate programs.

*Continued on next page.*



## EXTRA RINSE BUTTON

This button sets the program to add one or two rinse cycles. The button will glow when this option is on. See the Wash Programs table below for an explanation of the number of rinse cycles added to each program. Three rinses are usually sufficient, but if you live in an area with very soft water or you are allergic to detergent, you may want to use this option. This option is only available with the Heavy Stain, Normal and Rinse programs.

## START BUTTON

After you have set the program, a drying time, and prewash or extra rinse option, press this button to start the program.

## WASH PROGRAMS

The table below defines each wash program in detail to help you determine which program is best for each type of load.

Program	Temp	Soil Level	Fabrics	Load Size (1)	Program Description	Spin Speed	Options Available	
							Pre Wash	Extra Rinse
<b>REGULAR</b>								
Heavy Stain (2)	Hot	Heavy	Cottons, Linens	Full	Long main wash, 3 rinses, drain & spin	1200	Yes	2
Whites	Hot	Heavy	Cottons, Linens, Blends, Synthetics	Full	Main wash, 3 rinses, drain & spin	1200	Yes	2
Color Fast	Warm	Heavy	Cottons, Linens, Blends, Synthetics	Full	Main wash, 3 rinses, drain & spin	1200	Yes	2
Color	Cold	Light	Cottons, Linens, Blends, Synthetics	Full	Main wash, 3 rinses, drain & spin	1200	Yes	2
<b>PERMA PRESS</b>								
Heavy Stain (2)	Hot	Heavy	Cottons, Linens, Blends, Synthetics	Half	Long main wash, 3 rinses, drain & spin	1200	Yes	1
Color Fast	Warm	Light	Cottons, Linens, Blends, Synthetics	Half	Main wash, 3 rinses, drain & spin	1200	Yes	1
Color	Cold	Light	Cottons, Linens, Blends, Synthetics	Half	Main wash, 3 rinses, drain & spin	1200	Yes	1
<b>DELICATE</b>								
Wool/Hand Wash (3)	Warm	Light	Machine-washable wool and silk, nylon	One-third	High-water level wash, 3 rinses, drain, gentle spin	800	n/a	1
Quick Wash	Cold	Light	Machine-washable wool and silk, nylon	Full	High-water level wash, 2 rinses, drain, gentle spin	1200	n/a	n/a
Spin	n/a	n/a	Cottons, Linens, Blends, Synthetics	Full	Drain & intensive spin	1200	n/a	n/a
Dry	n/a	n/a		Full	Dry only	n/a	n/a	n/a

### NOTES:

- (1) For an explanation of the recommended load sizes, see page 6.
- (2) When you select the Heavy Stain program, the unit heats the water to 140° F for the main wash.
- (3) The Wool/Hand Wash program has an 800 rpm spin speed to eliminate stress on delicate fabrics.

## INSTRUCTIONS FOR USING THE WASHER/DRYER

### **WARNING!**

To reduce the risk of fire, electric shock, or injury to persons, read the **IMPORTANT SAFETY INSTRUCTIONS** before operating this appliance.

Below are instructions for using the machine. Refer to pages 8 and 9 for explanations of the control panel functions and programs.

1. Before placing the items in the machine, sort the laundry by type of fabric and care label instructions (see page 7).
2. Make sure nothing is in the garment pockets to avoid damage to clothes, the machine or the filter.
3. Close zippers and hooks to prevent snagging.
4. Open the door (Fig. 8).
5. Load the laundry and close the door securely.
6. Pour detergent and fabric softener into the appropriate compartments in the detergent drawer (Fig. 9).

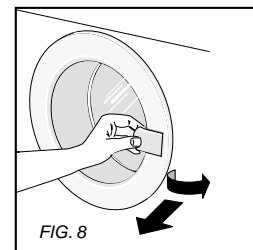

**NOTE:** Use only low sudsing detergent made for front-loading washers and follow label instructions. The amount of detergent varies among the different brands, but for most detergents, you need only one or two tablespoons. Too much detergent could leave a residue on your clothes and possibly damage the appliance.

Do not add detergent to the prewash compartment unless you are using a wash program that has a prewash cycle; otherwise, the machine could oversuds and spill onto the floor. Also, do not use liquid detergent for a prewash program because the detergent will be washed out the back of the drawer.

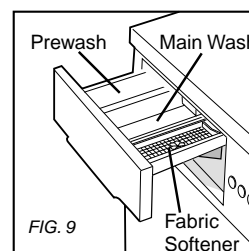

**NOTE:** It is not recommended that you use bleach in your ASKO combination washer/dryer. If you need extra whitening, we recommend that you use a low-sudsing powder detergent with bleach additive.

**NOTE:** Excessive use of fabric softener can damage garments.

7. Close the detergent drawer securely.
- Caution!** To avoid water spillage, do not open the detergent drawer while the machine is operating.
8. Press the On/Off button. (The indicator light should come on.)
9. Turn the Program Knob to the desired program.
10. Turn the Drying Time Knob to the desired number of minutes.
11. Press the desired option buttons (Prewash or Extra Rinse).
12. Press the Start button. The machine will start

**NOTE:** For safety reasons, there is a two-minute delay at the end of a program before you can open the door.

## CARE AND MAINTENANCE

The machine does not require special care; however, to best ensure a long life, certain precautions are recommended (see page 3).

**WARNING!** Before performing the operations described below, make sure that the power is off and the unit is unplugged.

### CLEANING THE DETERGENT DRAWER

The drawer should be cleaned periodically with a damp, slightly soapy cloth.

**CAUTION:** Never clean the door with cleaning solvents or abrasive cleansers. You could damage the finish.

You can remove the drawer completely by pressing on the plastic part of the softener compartment marked "PUSH" (Fig. 10). Clean the drawer with a soft brush under warm running water.

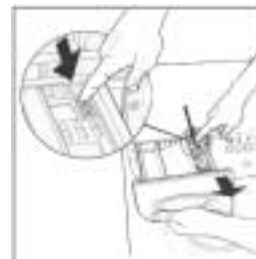

### CLEANING THE LINT FILTER

The lint filter should be cleaned about once a month. Make sure the unit has drained before opening the filter door.

1. Place a pan or towel under the filter door (Fig. 11), since a small amount of water could spill.
2. Remove the filter by turning it a half turn counterclockwise and pulling outwards (Fig. 12).
3. Clean the filter with a soft brush under running water until all residue is removed.
4. Replace the filter and turn it clockwise until it is securely locked in place (Fig. 13). Give the cap a gentle tug to confirm that the filter is in securely.

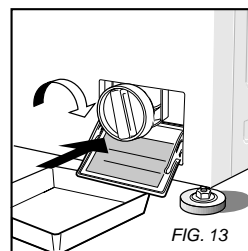
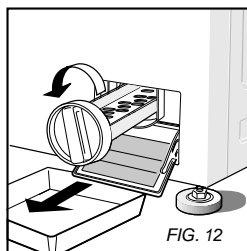
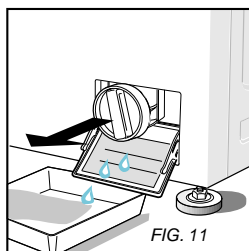

### CLEANING THE CONTROL PANEL

To clean the control panel, use only a warm, damp cloth. To prevent penetration of liquid into the door lock and electrical components, **never spray water or cleaning solvents on the control panel**. Also, never use abrasive cleaners or scouring pads on the outer surfaces because they will scratch the finish and could remove the writing on the control panel. Some paper towels may also scratch the finish.

## COMMON LAUNDRY PROBLEMS

Most items can be safely washed in an ASKO Combination Washer/Dryer. We recommend that you follow the care label instructions as closely as possible for the best cleaning results. Should problems occur, some possible causes and suggested solutions are listed below.

**NOTE:** ASKO has no control over what is put in our appliances once installed in a customer's home. **You are solely responsible for what you put in your ASKO Combination Washer/Dryer.**

Problem	Possible Cause	Suggested Solution
Graying	Not enough detergent	You may need to add slightly more detergent if clothes are heavily soiled, have oily stains, or if your water is very hard.
	Water not hot enough	Select a hotter temperature setting for each type of load.
	Improperly prewashed or presoaked	Be sure to add a prewash and/or presoak for heavily soiled or oily items.
	Unit overload	Once wet, the clothes must have room to tumble freely, especially synthetics and permanent press.
	Soap used in hard water areas	Be sure you use a laundry detergent, not a "soap." Soap reacts with the minerals in hard water to form a soap curd, which can be deposited on clothes.
Lint or residue left on clothes	Improper sorting of clothes	Separate clothes that shed lint (chenille and terrycloth) from clothes that attract lint (synthetics, corduroy, velveteen).
	Non-phosphate detergent	Non-phosphate detergents can combine with minerals in hard water and form a residue which can appear to be lint. Use a low phosphate detergent. If possible, install a water softener.
	Fabric softener used improperly	Read labels. Most softeners should only be used in the final rinse. Add softener to the softener compartment. If added to the wash cycle, softeners can have a reaction with detergents, producing a white residue.
	Pilling	Pilling, which can look like lint, is produced by normal wear on cotton/polyester blend fabrics. To reduce pilling, wash these fabrics inside out. For the best results, wash in the delicate cycle.
Yellowing	Not enough detergent	Add slightly more detergent.
	Water not hot enough	Use the hottest recommended temperature for each type of load.
	Iron or manganese in water	If possible, install a water filter. A small amount of Calgon or other type of water conditioner added once a week is advisable in hard water areas.
Shrinkage	Improper washing or drying	Follow garment care label instructions carefully (see page 7). Some fabrics will shrink no matter how they are washed. Some may be machine washed but not machine dried.
Knit shrinkage	Overheating	Knits tend to shrink more than woven fabrics. If a knit has been heat-shaped, wash in cool or warm water. Dry with the low setting.
	Delayed or gradual shrinkage	This can occur when special stabilizing finishes are reduced from wear or repeated washings. Garment may sometimes be reshaped by pressing after washing and drying.
	Poor construction	Shrinkage can occur if the knit fabric was not stretched properly by the manufacturer. Press back into shape each time garment is washed and dried.
Fading and discoloring	Improper sorting	Dark clothes, especially cottons, can bleed excess dyes into wash water. White or light-colored clothes can absorb the dye and discolor. Separate light items from dark items.
	Crayons or pens in pockets	Always empty all pockets before washing.
	Water too hot	Cool or cold water is best for retaining dark or bright colors.
Stains	Incorrect water temperature	Protein stains, such as milk, egg, blood and soy formula should be removed in cold water. Oily stains should be washed in the hottest water recommended for each fabric type.
	Old stains	The longer a stain remains on a fabric, the harder it is to remove. Treat stains promptly. Do not set stains by machine drying or ironing fabrics until stains are completely removed.

## COMMON LAUNDRY PROBLEMS (cont'd)

<b>Problem</b>	<b>Possible Cause</b>	<b>Suggested Solution</b>
Excessive wrinkling	Machine too full	Permanent press items should be washed in half-loads to prevent wrinkling. If possible, use a slower spin speed.
	Water too hot	Use lower wash temperature settings.
Rips, snags, excess wear	Sharp objects in pockets	Empty all pockets and turn inside out before laundering.
	Hooks, snaps, zippers, buckles	Fasten all hooks, snaps, and zippers before laundering to avoid snags. Remove sharp buckles. Turn knits inside out.
	Harsh chemicals	Before washing, rinse harsh chemicals (such as battery acid, hair care chemicals, cleaning solutions, etc.) from towels and other articles to avoid holes in fabrics. Do not allow these unrinsed items to contact other fabrics.
	Existing rips and tears	Mend all garments before laundering to prevent enlarging of rips.
	Permanent press items	These items may fray at edges from normal wear, not the washer. Wash only in half loads and don't wash in the same load with heavy items, such as towels or jeans.

# TROUBLESHOOTING

Before calling for technical assistance, check that the operations described below have been carried out correctly; this will save both time and money.

## ***Does not work/Indicator light is not lit***

Check that:

- 1) The On/Off button is pressed in.
- 2) The plug is correctly inserted in the socket.
- 3) The main power supply is on.

## ***Indicator light is on but unit does not work***

Check that:

- 1) The door is closed securely.
- 2) The On/Off button is pressed in.
- 3) The programmer knob is on a program.
- 4) The plug is correctly inserted in the socket.
- 5) The main power supply is on.
- 6) See "Does not fill with water" below.

## ***Does not fill with water***

Check that:

- 1) There is water in the pipes.
- 2) The tap to the water source is open.
- 3) The water supply hose is not kinked.
- 4) The inlet filter between the valve and water feed hose is clean (see page 6).

## ***Fills and drains continuously***

Check that:

- 1) The drain hose is positioned at the correct height (see page 6).
- 2) If connected to a sink, the drain hose outlet is not under water.

## ***Does not drain and spin***

Check that:

- 1) The No Spin button is not pressed in.
- 2) The drain hose is in the correct position.
- 3) The drain hose is not kinked.
- 4) The amount of detergent is not excessive.
- 5) The detergent dispenser is not encrusted with residue.
- 6) The detergent is low-sudsing specifically for front-loading washers.

## ***Vibrates and is noisy***

Check that:

- 1) Large items have not become entangled (sheets, tablecloths, etc.).
- 2) The machine is level (see page 5).
- 3) The four packing screws, spacers and two lower rods have been removed (see page 5).

## ***The door will not open***

- 1) For safety reasons, the door remains locked for two to three minutes after the program has finished.

If you think you have resolved the problem, try starting the machine again. If the problem persists, call for technical assistance (see page 15).

## **BEFORE CALLING FOR SERVICE**

Before calling for service or contacting AM Appliance Group regarding a warranty issue, be prepared to explain:

- 1) The appliance model number (shown on the detergent dispenser)
- 2) The serial number of the machine (located on the inner door facing)
- 3) The specific problem

# PRODUCT WARRANTY

MODEL WCAM 1812

Be sure to complete the Warranty Registration Card you received with your appliance and mail it to AM Appliance Group to validate your appliance warranty.

Cosmetic damage must be reported to your dealer within five days from the date of purchase. After unpacking the unit, thoroughly check it for cosmetic damage.

## FOR RESIDENTIAL INSTALLATIONS ONLY

<b>LENGTH OF WARRANTY</b>	<b>AM APPLIANCE GROUP WILL PAY FOR:</b>
<b>Three-Year Full</b> From date of purchase.	ASKO replacement parts and/or repair labor to correct defect in materials or workmanship. Service must be provided by an authorized ASKO service agent.
<b>Fourth &amp; Fifth Year Limited</b> Three year full plus fourth and fifth year limited from date of purchase.	ASKO replacement parts (labor cost not included) for any defective solid-state controls, timers, motors, or pumps. Service must be provided by an authorized ASKO service agent.
<b>Lifetime</b>	ASKO replacement parts (labor cost not included) of the stainless steel tank if it fails to hold water due to a manufacturing defect, such as rusting or cracking. Service must be provided by an authorized ASKO service agent.

## FOR NON-RESIDENTIAL INSTALLATIONS

<b>Six-Month Full Warranty</b> From date of purchase.	ASKO replacement parts and/or repair labor to correct defect in materials or workmanship. Service must be provided by an authorized ASKO service agent.
--	---

## AM APPLIANCE GROUP WILL NOT PAY FOR:

- A. Service calls to:
  1. Correct the installation of the appliance.
  2. Repair damage due to shipment, delivery, installation, misuse or abuse.
  3. Instruct how to use the appliance.
  4. Replace house fuses or correct house wiring.
  5. Correct house plumbing, including drainage problems related to improper installation.
  6. Clean or service air device in drain line.
- B. Repair and/or replacement parts for failure of product if appliance is used for other than residential use.
- C. Damage resulting from accident, fire, floods, acts of God, alteration, misuse, abuse, improper installation, or installation not in accordance with local electrical or plumbing codes.
- D. Any shipping costs for parts during the limited warranty period.
- E. Replacement parts or repair labor costs for units operated outside the continental United States.
- F. Pickup and delivery. ASKO appliances are designed to be repaired in the home.

### IN NO EVENT SHALL AM APPLIANCE GROUP BE RESPONSIBLE FOR ANY INCIDENTAL OR CONSEQUENTIAL DAMAGES.

Some states will not allow the exclusion or limitation of incidental or consequential damages, so this exclusion or limitation may not apply to you. This warranty gives you specific legal rights and you may also have other rights which vary from state to state.

**For warranty service, contact the dealer from whom you purchased the unit or an authorized ASKO service agent.** Service will be provided during normal business hours. Should you have a service problem that cannot be resolved locally, contact AM Appliance Group at the numbers listed below. Before calling for service or contacting AM Appliance Group regarding a warranty issue, make a note of the model, type name, and serial number.

Write to us at:  
 AM Appliance Group  
 P. O. Box 851805  
 Richardson, Texas 75085-1805  
 www.askousa.com

Or call our  
 ASKO Advisory Center a  
 Division of AM Appliance Group at  
 800-898-1879 or  
 972-238-0794

# QUICK REFERENCE GUIDE

(Refer to pages 8–10 for detailed operating instructions.)

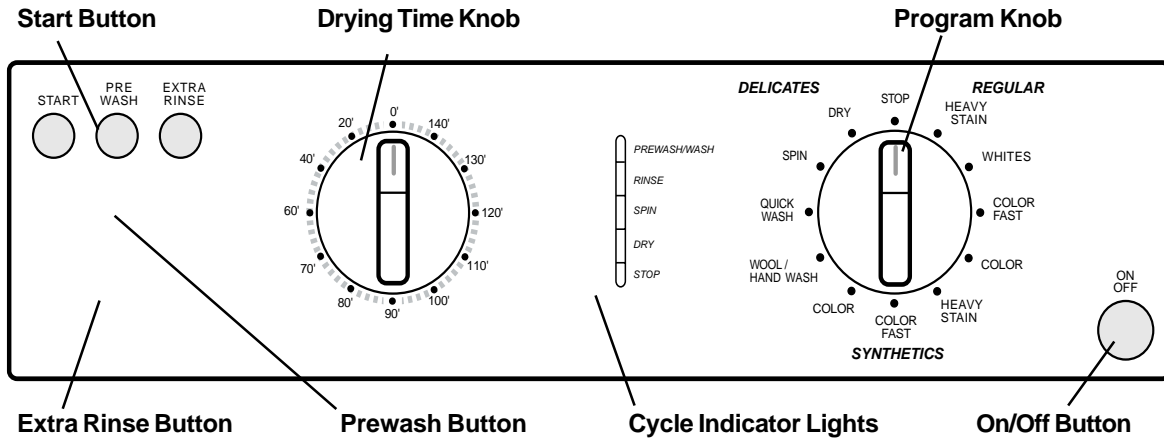

## WASH PROGRAMS

The table below defines each wash program in detail to help you determine which program is best.

REGULAR									
Program	Temp	Soil Level	Fabrics	Load Size (Note 1)	Program Description	Spin Speed	Options Available		
							Pre Wash	Extra Rinse	
Heavy Stain (Note 2)	Hot	Heavy	Cottons, Linens	Full	Long main wash, 3 rinses, drain & spin	1200	Yes	2	
Whites	Hot	Heavy	Cottons, Linens, Blends, Synthetics	Full	Main wash, 3 rinses, drain & spin	1200	Yes	2	
Color Fast	Warm	Heavy	Cottons, Linens, Blends, Synthetics	Full	Main wash, 3 rinses, drain & spin	1200	Yes	2	
Color	Cold	Light	Cottons, Linens, Blends, Synthetics	Full	Main wash, 3 rinses, drain & spin	1200	Yes	2	
PERMA PRESS									
Program	Temp Options	Soil Level	Fabrics	Load Size (Note 1)	Program Description	Spin Speed	Options Available		
							Pre Wash	Extra Rinse	
Heavy Stain (Note 2)	Hot	Heavy	Cottons, Linens, Blends, Synthetics	Half	Long main wash, 3 rinses, drain & spin	1200	Yes	1	
Color Fast	Warm	Light	Cottons, Linens, Blends, Synthetics	Half	Main wash, 3 rinses, drain & spin	1200	Yes	1	
Color	Cold	Light	Cottons, Linens, Blends, Synthetics	Half	Main wash, 3 rinses, drain & spin	1200	Yes	1	
DELICATE									
Program	Temp Options	Soil Level	Fabrics	Load Size (Note 1)	Program Description	Spin Speed	Options Available		
							Pre Wash	Extra Rinse	
Wool/Hand Wash (Note 3)	Warm	Light	Machine-washable wool and silk, nylon	One-third	High-water level wash, 3 rinses, drain, gentle spin	800	n/a	1	
Quick Wash	Cold	Light	Machine-washable wool and silk, nylon	Full	High-water level wash, 2 rinses, drain, gentle spin	1200	n/a	1	
Spin	n/a	n/a	Cottons, Linens, Blends, Synthetics	Full	Drain & intensive spin	1200	n/a	1	
Dry	n/a	n/a		Full	Dry only	n/a	n/a	n/a	

### NOTES:

- (1) For an explanation of the recommended load sizes, see page 6.
- (2) When you select the Heavy Stain program, the unit heats the water to 140° F for the main wash.
- (3) The Wool/Hand Wash program has an 800 rpm spin speed to eliminate stress on delicate fabrics.