

Viking Use & Care Manual



Viking Range Corporation

111 Front Street

Greenwood, Mississippi 38930 USA

(662) 455-1200

For product information

call 1-888-VIKING1 (845-4641)

or visit the Viking Web Site at

vikingrange.com

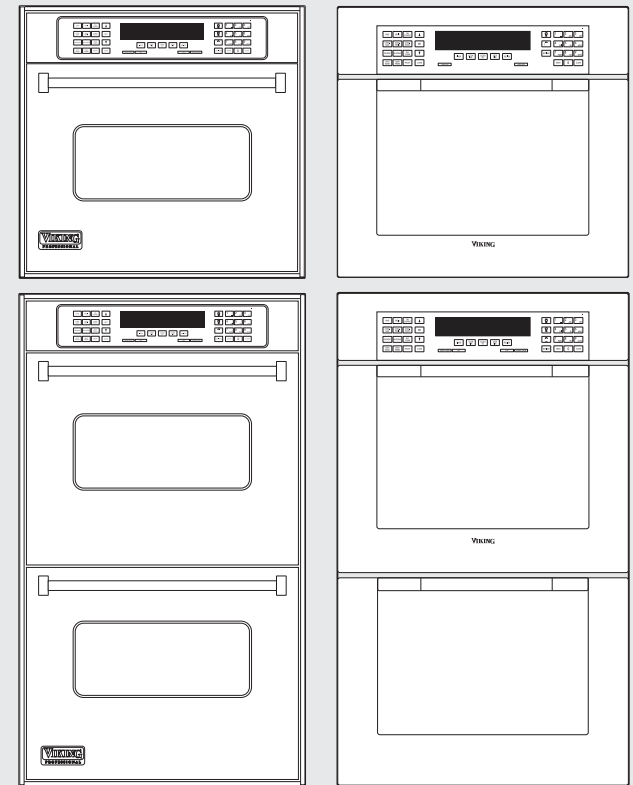

Professional & Designer Series
Built-In Electric Touch Control
Single and Double Ovens

Congratulations

Your purchase of this product attests to the importance you place upon the quality and performance of the major appliances you use. With minimal care, as outlined in this guide, this product is designed to provide you with years of dependable service. Please take the few minutes necessary to learn the proper and efficient use and care of this quality product.

Some key features of this appliance include:

- 14 different cooking modes to make even your most challenging baking projects a success.
- Split baking and broiling elements, reducing your preheating time and heating your food more evenly.
- An extra-large reversing fan, allowing you to cook even large quantities of food more quickly and evenly.
- Four convection modes, offering greater air circulation to shorten cooking times and cook foods more evenly.
- Dual broiling elements, producing intense radiant heat for faster broiling and a larger coverage area.
- Three broiling modes, including a special low-broil mode for delicate broiling and top-browning.
- A profiled, hidden bake element for easier cleaning.
- Six adjustable rack positions with the largest usable baking space available in this class.

Your complete satisfaction is our ultimate goal. If you have any questions or comments about this product, please contact the dealer from whom you purchased this product, or contact our consumer support center at 1-888-VIKING1.

We appreciate your choosing a Viking® Range Corporation product and hope that you will again select our products for your other major appliance needs. For more information about the complete selection of Viking products, contact your dealer or go to vikingrange.com.

Warnings

WARNING

If the information in this manual is not followed exactly, a fire or explosion may result causing property damage, personal injury or death.

WARNING

NEVER use this appliance as a space heater to heat or warm the room. Doing so may result in carbon monoxide poisoning and overheating of the oven.

WARNING

Do not use commercial oven cleaners inside the oven. Use of these cleaners can produce hazardous fumes or can damage the porcelain finishes.

WARNING

NEVER cover any slots, holes or passages in the oven bottom or cover an entire rack with materials such as aluminum foil. Doing so blocks air flow through the oven and may cause carbon monoxide poisoning. Aluminum foil linings may also trap heat, causing a fire hazard.

WARNING

To avoid sickness and food waste when using automatic time baking:

- Do not use foods that will spoil while waiting for cooking to start, such as dishes with milk or eggs, cream soups, custards, fish, pork, poultry, or foods with stuffing.
- Any food that has to wait for cooking to start should be very cold or frozen before it is placed in the oven.
- Do not use foods containing baking powder or yeast when automatic time baking. They will not rise properly.
- Do not allow food to remain in the oven for more than two hours after the end of the cooking cycle.

WARNING

To avoid sickness and food waste, do not allow defrosted food to remain in the oven for more than two hours.

Table of Contents

Getting Started

Important Safety Instructions _____ 6

Product Controls

Oven Control Panel _____ 8

Built-In Electric Oven Features _____ 10

Touch Pad Functions _____ 11

Programming Modes

Clocks and Timers

Setting the Clock _____ 16

Setting the Timer _____ 17

Cook Time and Stop Time _____ 18

Oven Settings

Brightness _____ 20

Degree Format (Fahrenheit or Celsius) _____ 20

Tones _____ 21

Tone Volume _____ 23

Timeouts _____ 23

Clock Format (12-hour or 24-hour) _____ 24

Sabbath Mode _____ 25

Showroom Mode _____ 25

Lock and Unlock _____ 26

Interior Oven Lights _____ 26

Recipe Function _____ 27

Warming Modes _____ 29

Bake Modes _____ 30

Broil Modes _____ 33

Roast Modes _____ 35

Meat Probe _____ 37

Table of Contents

Cooking Tips

Rack Positions _____ 39

Pan Placement Tips _____ 40

Baking Tips _____ 40

Multiple Rack Baking _____ 41

Conventional Baking Chart _____ 42

Convection Baking Chart _____ 43

Solving Baking Problems _____ 44

Broiling Tips _____ 45

Broiling Chart _____ 46

Roasting Tips _____ 47

Conventional Roasting Chart _____ 48

Convection Roasting Chart _____ 49

Product Care

Cleaning and Maintenance _____ 50

 Self-Clean Cycle _____ 53

Replacing Light _____ 54

Trouble Shooting _____ 55

Error Handling _____ 55

Service Information _____ 56

Warranty _____ 57

Important Safety Instructions

- Use this appliance only for its intended use as described in this manual. Never use your appliance for warming or heating the room. This is based on safety considerations.
- Your unit should be installed by a qualified technician. The appliance must be installed and electrically grounded according to local codes.
- Do not attempt to repair or replace any part of this appliance unless specifically recommended in this manual. All servicing should be referred to a qualified technician. Warranty service must be performed by an authorized service agency.
- Children should not be left alone in the kitchen while the oven is in use. They should never be allowed to sit or stand on any part of the appliance.

CAUTION: Do not store items of interest to children over the unit. Children climbing to reach items could be seriously injured. They should never be allowed to sit or stand on any part of the appliance.

- **GREASE** - Grease is flammable and should be handled carefully. Do not use water on grease fires. Flaming grease can be extinguished with baking soda or, if available, a multipurpose dry chemical or foam-type extinguisher. Let fat cool before attempting to handle it. Do not allow grease to collect around the oven or in vents. Wipe up spillovers immediately.
- Loose-fitting or hanging garments should never be worn while using the appliance. Do not drape towels or materials on oven door handles. These items could ignite and cause burns.
- Use only dry potholders. Moist or damp potholders on hot surfaces may result in burns from steam. Do not let potholder touch hot surface areas. Do not use a towel or other bulky cloth.
- Keep area clean and free from combustible materials, gasoline, and other flammable liquids. Never use your oven as a storage space. Combustible items (paper, plastic, etc.) may ignite, and metallic items may become hot and cause burns.

Important Safety Instructions

- Do not heat unopened food containers; build-up of pressure may cause the container to explode and result in injury.
- Always position oven racks in desired location while oven is cool. If rack must be moved while oven is hot, do not let potholder contact hot heating element in oven.
- Use care when opening oven door. Let hot air or steam escape before removing or replacing food. Hot air or steam can cause burns to hands, face and/or eyes.
- Keep oven vents unobstructed. The oven vent is located at the front of the oven and vents into the room.
- Do not clean door gasket. It is essential for a good tight seal. Care should be taken not to rub, damage, or move the gasket.
- No commercial oven cleaner or oven liner protective coating such as aluminum foil should be used in or around any part of the oven. Improper oven liners may result in a risk of electric shock or fire. Keep oven free from grease buildup.
- Before self-cleaning the oven, remove broiler pan, broiler grid, oven racks, and other utensils. Do not use your oven to clean other parts. A fan noise should be heard during the cleaning cycle. If not, call service before self-cleaning again.
- **DO NOT TOUCH HEATING ELEMENTS OR INTERIOR SURFACES OF OVEN.** Heating elements may be hot even though they are dark in color. Interior surfaces of an oven become hot enough to cause burns. During and after use, do not touch or let clothing or other flammable materials contact heating elements or interior surfaces of oven until they have had sufficient time to cool. Other surfaces of the oven may become hot enough to cause burns, such as the oven vent opening, the surface near the vent opening, and the oven door window.

Oven Control Panel

Oven Control Panel

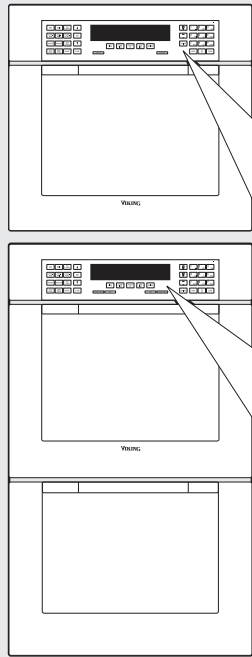

Oven Function and Temperature Controls

Each oven function has a separate setting. (See descriptions)
The SET control up and down arrows can be used to set any temperature from 150°F (65.6°C) to 550°F (287.8°C).

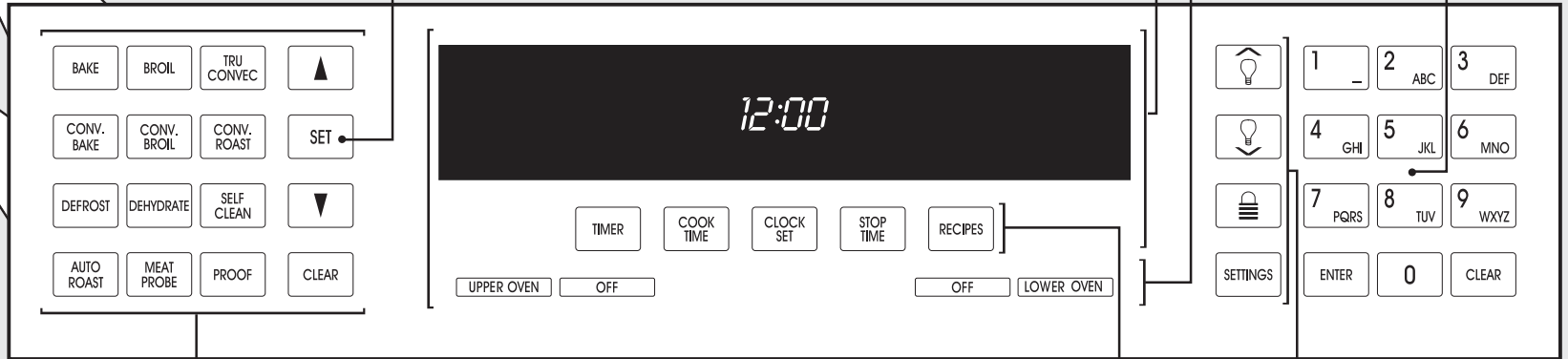

Electronic Timing Center

The Electronic Timing Center is used to program and control all timing functions.

IMPORTANT—The time-of-day must be set before any other program can be used.

Oven Selector Controls

The Oven Selector Controls are used to turn the upper or lower oven on and off.

Electronic Keypad Entry

The Electronic Keypad Entry is used to program and control all oven functions.

Oven Selector Options

Bake

Conventional, single-rack baking (breads, cakes, cookies, pastry, pies, entrees, vegetables)

Convection Bake

Multi-rack baking for heavier or frozen foods (e.g., frozen pies, pizzas, entrees, vegetables)

Defrost

Natural defrosting of food using fan without heat

Auto Roast*

Automatic searing of the outside of meats; simplifies roasting

Broil

Three conventional broil settings for cuts of flat pieces of meat or meat 1-2 inches thick

Convection Broil

Faster than regular broiling with less smoke generation for thicker meats

Dehydrate

Using the convection fan over a period of time, water is removed from food by evaporation

Meat Probe*

Automatically turns the oven off when the internal temperature of the meat being roasted is reached

TruConvect™

Multi-rack baking for breads, cakes, cookies (up to 6 racks of cookies at once)

Convection Roast

Roasting whole turkeys, whole chickens, hams, etc.

Self-Clean

A self-cleaning cycle using high heat to burn off soils and deposits

Proof*

Creates an optimal environment for the rising of yeast in many kinds of dough

Recipes*

Accesses, programs, and saves cooking cycles from favorite recipes

Oven Light Controls

Controls the interior lights in the upper and lower ovens

Oven Lock

Childproofing feature preventing the controls from being activated when the oven is not in use

Settings

Accesses custom features such as display brightness, Sabbath/Showroom modes, and tones

*Note: Designer Series Premiere model control panel and features are shown.

Product Controls

Product Controls

Built-In Electric Oven Features

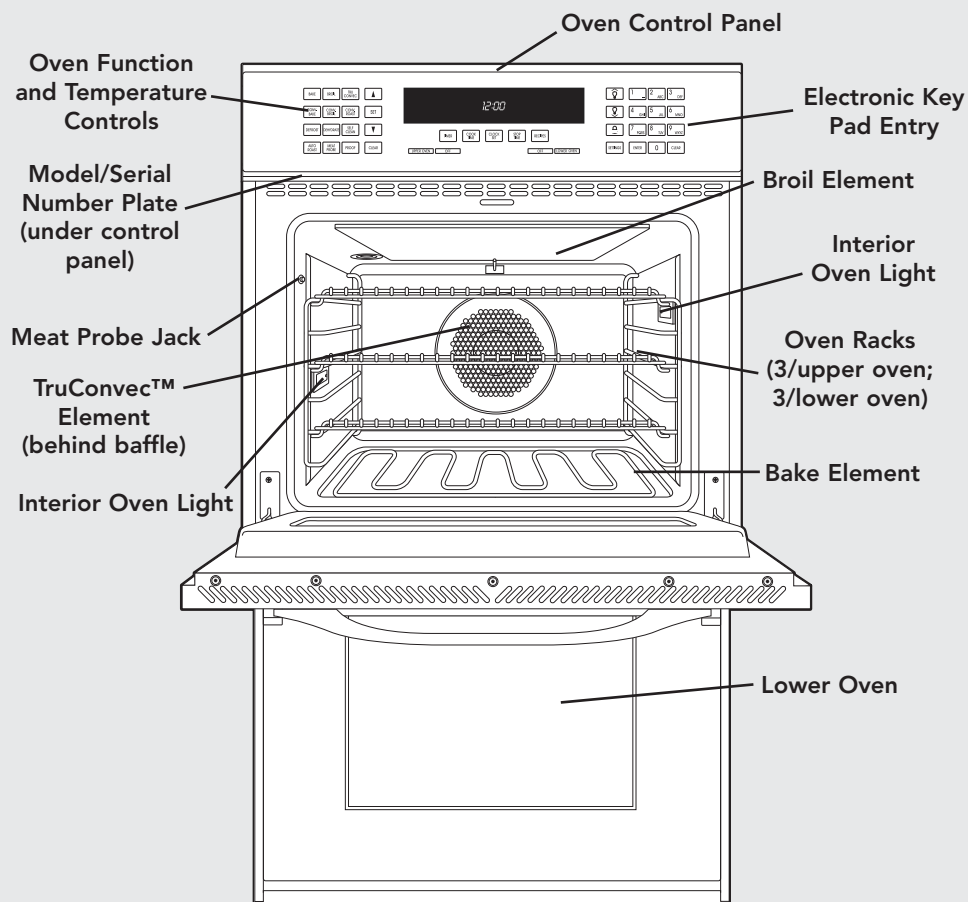

Designer Series Premiere double oven is shown above.

Meat Probe (available on Premiere models)

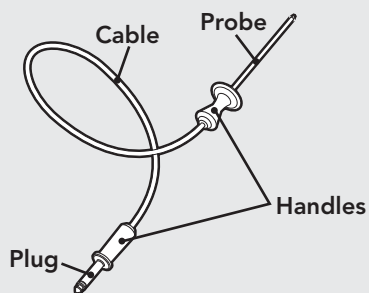

Touch Pad Functions

Temperature Control

Both ovens share the temperature control. To use this feature, select the upper or lower oven, and then set the desired temperature. The controls can be set at any temperature from 150° F (65.6° C) to 550° F (287.8° C).

Electronic Keypad Entry

Both ovens share the electronic keypad entry. The alphanumeric keys can be used to program and control all oven functions.

Oven Function Selector Control

Both ovens offer 14 separate cooking modes from which you can choose the one that best meets your cooking needs.

Bake

When using this function, full-power heat is radiated from the bake element in the bottom of the oven cavity, while supplemental heat is radiated from the broil element. This function is recommended for single-rack baking. Use this setting for baking, roasting, and casseroles.

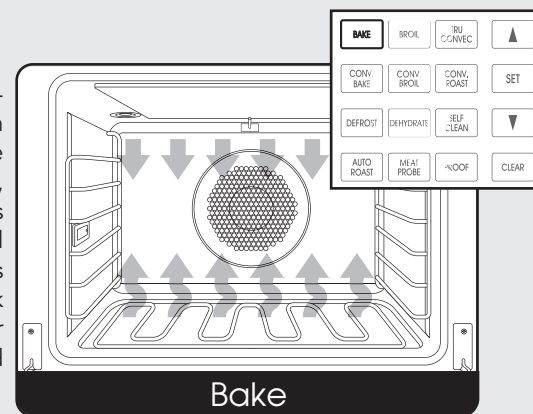

Broil

This function is a dry-heat cooking method, using direct or radiant heat on three different settings: low, medium and high. The distance between the foods and the broil elements determines broiling speed. This function is recommended for small, individualized cuts, such as steaks, chops and patties.

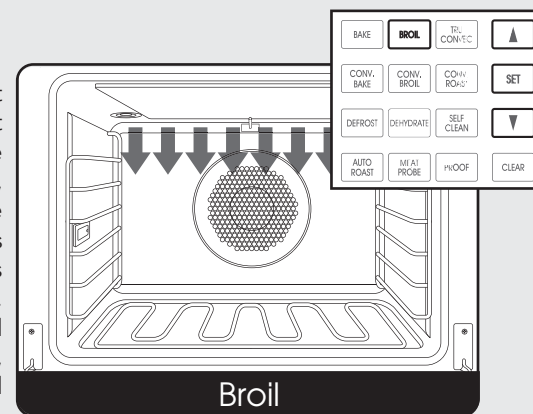

Touch Pad Functions

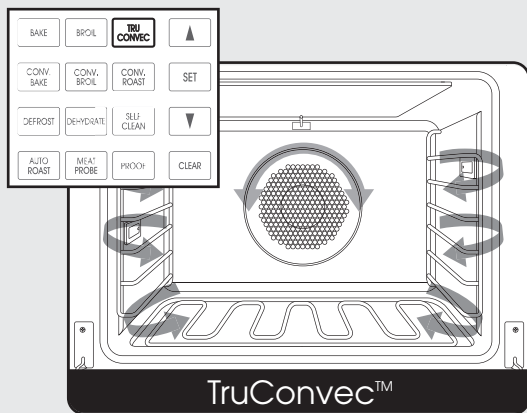

TruConvec™

With this function, only the rear element operates at full power. There is no direct heat from the bottom or top elements, and the motorized fan in the rear of the oven circulates for even heating. Use this setting for foods that require gentle cooking, such as pastries, soufflés, yeast breads, quick breads, and cakes. This setting produces breads, cookies, and other baked goods with an

even texture and golden crusts. No special bakeware is required. Use this function for single-rack baking, multiple-rack baking, roasting, and preparation of complete meals. This setting is also recommended when preparing large quantities of baked goods at one time.

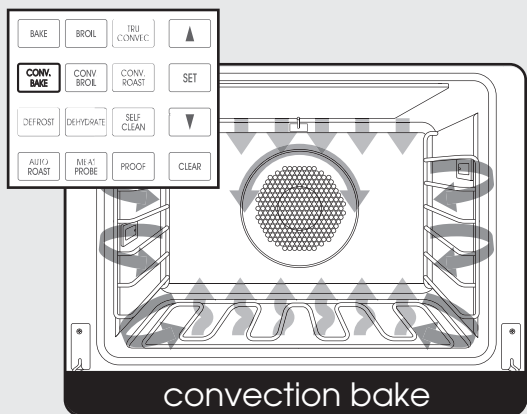

Convection Bake

With this function, the bottom element operates at full power, and the top broil element operates at supplemental power. The motorized fan in the rear of the oven circulates heated air, providing a more even heat distribution. This even circulation of air equalizes the temperature throughout the oven cavity and eliminates the hot and cold spots found in

conventional ovens. A major benefit of convection baking is the ability to prepare food in larger quantities using multiple racks. When roasting using this setting, cool air is quickly replaced, searing meats on the outside and retaining more juices and natural flavor on the inside with less shrinkage. With this heating method, foods can be baked and roasted at the same time with minimal taste transfer, even when different dishes are involved, such as cakes, fish, or meat. The hot air system is especially economical when thawing frozen food. Use this setting for baking and roasting.

Touch Pad Functions

Convection Broil

Using this function, the top element operates at full power. This function is exactly the same as regular broiling with the additional benefit of air circulation by the motorized fan in the rear of the oven. Smoke is reduced since the airflow also reduces peak temperatures on the food. Use this setting for broiling thick cuts of meat.

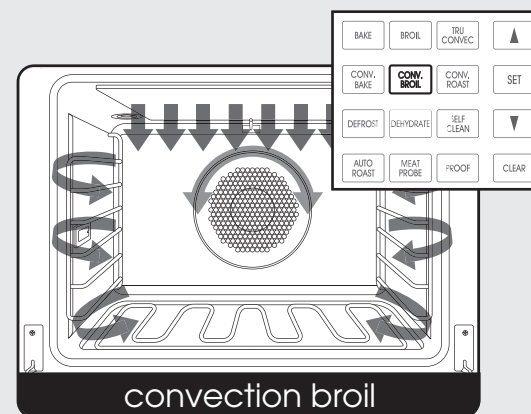

Convection Roast

With this function, the convection element runs in conjunction with the inner and outer broil elements. The reversible convection fan runs at a higher speed in each direction, allowing the moisture to be sealed inside large cuts of meat, such as roasts. This saves time when compared with single fan convection roast modes. Use this setting for whole turkeys, whole chickens, and roasts.

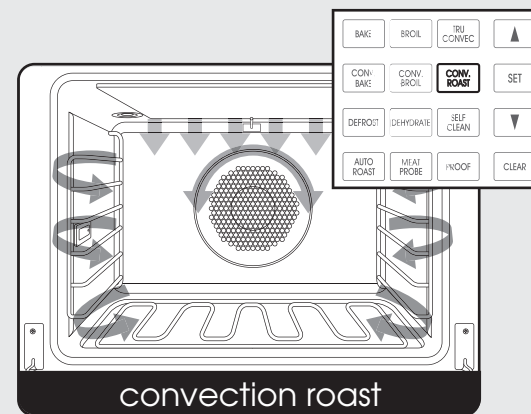

NOTE: Because this function uses a high-speed convection fan for optimum cooking performance, some noise may be noticed from this high fan speed. This is normal.

Defrost

With the temperature control off, a motorized fan in the rear of the oven circulates air. This fan accelerates natural defrosting of the food without heat.

NOTE: To avoid sickness and food waste, do not allow defrosted food to remain in the oven for more than two hours.

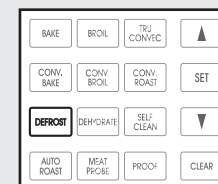

Touch Pad Functions

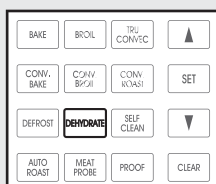

Dehydrate

With this function, a motorized fan in the rear of the oven circulates warm air. Over a period of time, the water is removed from the food by evaporation. Removal of water inhibits growth of microorganisms and retards the activity of enzymes. It is important to remember that dehydration does not improve quality; only fresh, top-quality foods should be dehydrated in your oven.

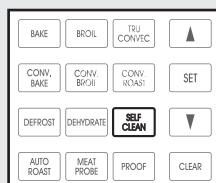

Self-Clean

The self-cleaning cycle is designed to eliminate the need for scrubbing and scouring food baked onto the oven interior. During this cycle, the oven uses high temperatures to burn off soils and deposits. An integral smoke eliminator reduces odors associated with the soil burn-off. A powder ash residue is left in the bottom of the oven after completion of the self-clean cycle. When the oven has cooled, remove any ash from oven surfaces with a damp sponge or cloth.

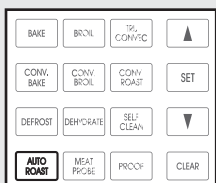

Auto Roast*

This function further simplifies roasting by automatically searing the outside of meats, raising the pre-set temperature by 100° F for a short time to sear the outside of the meat. The temperature then returns to the pre-set temperature in the standard convection roast mode.

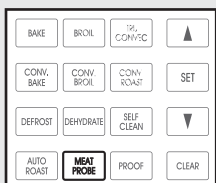

Meat Probe*

The probe temperature function is used to automatically turn the oven off when the internal temperature of meat being cooked is reached.

Touch Pad Functions

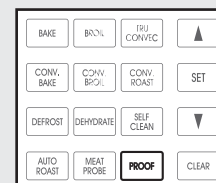

Proof*

This function uses a low temperature to create an optimal environment for the yeast to rise in many types of dough.

Recipes*

This setting accesses, programs, and saves cooking cycles from favorite recipes.



Interior Oven Light Controls

The upper and lower ovens have interior oven lights controlled by the right touch pad. Push the light button to turn the interior oven lights on and off.

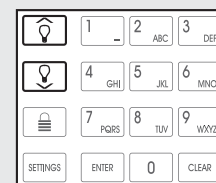

Oven Lock

This child protection function prevents the oven controls from being activated when the oven is not in use.

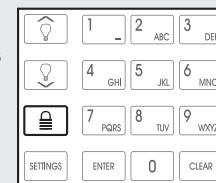

Settings

Use this function to access, program, and customize special features of your oven. Special features include tones, timeouts, display brightness, and the Sabbath mode.

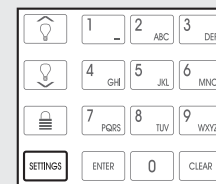

*Note: The AUTO-ROAST, PROOF, RECIPE and PROBE functions are included on the Premiere models.

Clocks and Timers

Electronic Timing Center

The Electronic Timing Center is used to program and control all timing functions on your Viking appliance.

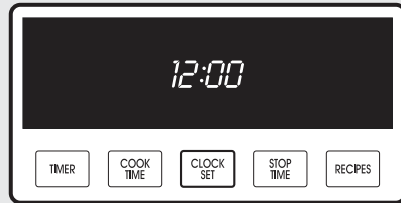

It has four display and programming modes that are activated by the four push buttons. Both the Timer and the Cook Time/Stop Time Modes can be used to time cooking periods. These features can even be used at the same time when both ovens are in use. For example, you can time-bake a casserole in the upper oven using the Cook Time/Stop Time Mode, while broiling in the lower oven using the Timer. One oven can also be cleaned while timing foods in the other oven using the timer.

Timer Alarm

- At the end of a program, the alarm will consist of three beeps, followed by two beeps every 10 seconds until the "CLEAR" button is pressed.
- Whenever a valid function key is pressed or when a control function starts automatically, one beep will sound.
- When an invalid function key is pressed, two beeps will sound.

Setting the Clock

The time-of-day must be set before any other program can be used. When your oven is first connected to the power in your home, the timer display will show 12:00.

To Program the Time-Of-Day:

1. Press either the "UPPER OVEN" or "LOWER OVEN" button.
2. Press the "CLOCK SET" button. The clock will begin to flash. The word "CLOCK" will be lit on the display.
3. Type in the correct time on the electronic number keypad.
4. Press the "CLOCK SET" button again. The clock is now set.

Alternate Method:

1. Press either the "UPPER OVEN" or "LOWER OVEN" button.
2. Press the "CLOCK SET" button. The clock will begin to flash. The word "CLOCK" will be lit on the display.

Clocks and Timers

3. Use the up and down arrows to change the current time.

	Press and Release	Press and Hold
s	Time increases by one minute	Time increases by 10 minutes
t	Time decreases by one minute	Time decreases by 10 minutes

4. Press the "SET" button on the temperature control or the "CLOCK SET" button on the electronic timing center. The clock is now set.

Note: The time-of-day cannot be changed while there is a Bake Hours or Start Time cycle programmed into the timer.

Setting the Timer

The timer is designed for accurate timing and is ideal for baking delicate items such as biscuits, cookies, and popovers, and for precise broiling. The timer can be used for timing up to 12 hours. When setting the timer, the time displayed will decrease in 1 minute increments. When the timer counts down to 1 minute, the timer alarm will give one short beep and the display will change to seconds. When the timer reaches 0:00, the alarm will give one long beep.

To Set the Timer:

1. Press the "TIMER" button. The timer will display "0:00" and the word "TIMER."
2. Type in the desired duration time on the electronic number keypad.
3. The timer will start automatically. (To cancel the entry, press the "CLEAR" button on the left side of the control panel before the count down begins and the time is still flashing.)
4. The timer is now set.

Alternate Method:

1. Press the "TIMER" button. The timer will display "0:00" and the word "TIMER" will be lit on the display.

Clocks and Timers

2. Use the up and down arrows to set the timer.

	Press and Release	Press and Hold
s	Time increases by one minute	Time increases by 10 minutes
t	Time decreases by one minute	Time decreases by 10 minutes

3. Press "SET" or "TIMER" to program the timer. (To cancel the entry, press the "CLEAR" button on the left side of the control panel.)
4. The timer is now set.

Cook Time and Stop Time

With the Viking oven, you can choose what times you need to start and stop cooking your food. The Cook Time and Stop Time functions allow you to program your preferences.

Here's how it works:

It is 2:00 PM and you would like to have your dinner ready at 6:00 PM. By programming your oven with a two-hour cook time and a 6:00 PM stop time, your oven will delay cooking until 3:50 PM. At 3:50, the oven will begin preheating. At 4:00 PM, the oven will begin its two-hour cook time.

Cook Time and Stop Time Facts:

Both ovens can be set individually for Cook Time and Stop Time functions.

To Set Cook Time:

1. Select UPPER OVEN or LOWER OVEN.
2. Select an oven function and temperature before setting Cook Time and Stop Time functions.
3. Press "COOK TIME" and the display will flash "0:00" and "COOK TIME" will be lit below.
4. Use numeric keyboard to enter the amount of time needed for cooking.
5. After the time is entered, the display will show "COOK TIME" under the timer field. (To cancel the entry, press the "CLEAR" button on the left side of the control panel.)

Clocks and Timers

6. Press "SET" or "ENTER" if the cook time is correct. Cook time is set.

NOTE: To cancel cook time during its cycle, press "COOK TIME" and then press the "CLEAR" button on the left side of the oven control. Cooking will continue if the oven is on.

To Set Stop Time:

1. Set Cook Time, following the steps provided in the previous section.
2. Press "STOP TIME" and "STOP TIME" will be lit on the display.
3. Use numeric keyboard to enter the time you want to stop for cooking.
4. After the time is entered, the display will flash the time. (To cancel stop time, press the "CLEAR" button on the left side of the control panel.)
5. Press "SET" or "STOP TIME" if the stop time is correct. Stop time is set and will begin when the oven is preheated.

NOTE: Display will show Cook Time and Stop Time. If you have entered a time incorrectly, you will hear a long beep and the display will not change.

NOTE: To cancel stop time during its cycle, press "STOP TIME" and then press the "CLEAR" button on the left side of the oven control. Cooking will continue if the oven is on.

When Stop Time has been reached:

1. Your oven will sound three beeps, and "HOLD" will appear on the display.
 - The oven will stay at 150° F in hold mode for two hours.
 - After two hours, the oven will sound four long beeps and shut off.
2. Press "OFF" to turn off the oven manually.

Oven Settings

These functions allow you to customize controls to suit your specific tastes.

Brightness

This mode offers users the ability to decrease or increase the intensity of the brightness of the electronic display panel. Users may choose between four levels of brightness: 25%, 50%, 75%, and 100%.

To customize brightness level:

1. Press "SETTINGS." Settings menu will appear in display.
2. Press the up or down arrows until "BRIGHTNESS: 100%" appears in the display. (The % shown is the current brightness level.)
3. Press "ENTER" to change brightness level. Current value will flash.
4. Move up and down arrows to select desired brightness level.
5. Press "ENTER" to confirm brightness level.
6. To exit the Settings menu, press "SETTINGS."

Degree Format

The oven has been preset to the Fahrenheit temperature scale. With this feature, users can switch to the Celsius temperature scale.

To change degree format to Celsius:

1. Press "SETTINGS." Settings menu will appear in display.
2. Press the up or down arrows until "DEGREES: FAHRENHEIT" appears in the display.
3. Press "ENTER" to change degree format. Current value will flash.
4. Use arrow keys to select "CELSIUS."
5. Press "ENTER" again to set degree format.
6. To exit the Settings menu, press "SETTINGS."

Oven Settings

Tones

This function allows you to define the duration of tones and the number of tones for different events. Your oven is programmed with different audible tones as demonstrated by the following chart:

Description of Tone	Used in...	Number of Tones	Duration (measured in seconds)
1 Minute Left	Min/Sec or Cook Timer	1	1
Autostart	Cooking mode or timer starts without pressing Set or Enter	2	0.1
End of Hold	Cook Time/Stop Time	4	1
Timer Expired	Min/Sec or Cook Timer	3	1
Failure	RTD error/Latch error	5	1
Invalid Entry	Error in programming	3	0.1
Periodic Reminder	After cooking mode finishes or during programming to prompt action by user	1	0.1
Key Press	Information Entry	1	0.1
Invalid Key	Information Entry	3	0.1
Repeat Key	Information Entry	0	0
Oven Light Off	Turning light off	2	0.1
Oven Light On	Turning light on	1	0.1

Oven Settings

Description of Tone	Used in...	Number of Tones	Duration (measured in seconds)
Panel is Locked	Information Entry	3	0.1
Setpoint Reached	Cooking Modes	1	1
Meat Probe	Roasting Modes	3	1
Meat Probe within 10 degrees	Roasting Modes	2	1
Searing Time Reached	Roasting Modes	3	1
Start Time Reached	Various Cooking Modes	1	1
Panel is Unlocked	Information Entry	2	0.1

To change the frequency and/or duration of any of the above tone signals:

1. Press "SETTINGS." Settings menu will appear in display.
2. Press the up or down arrows until "TONES..." appears in the display.
3. Press "ENTER," and "RESTORE FACTORY DEFAULTS: NO" appears on the display.
4. Scroll up or down using the arrow keys to find the Tone you would like to change and press "ENTER." Display will flash and appear as follows:

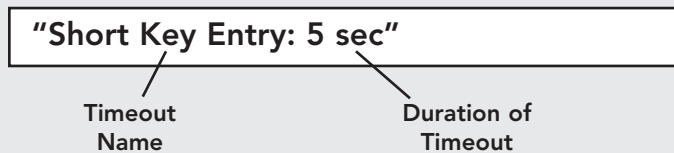

5. Press "ENTER," and the "1 x 1 SEC" value will flash.
6. Using the numeric keyboard, enter the number and the duration of tones desired. The number of tones can be a value from 0 to 9. The duration of tones is measured in tenths of a second. You can enter a number from 0.0 to 9.0.
7. Press "ENTER" when finished. The tone is customized to your preference. At this point the oven plays the new tone. If you do not like it, return to Step 10 to adjust the tone.
8. To exit the Settings menu, press "SETTINGS."

Oven Settings

Tone Volume

To change the TONE volume setting,

1. Press "SETTINGS." Settings menu will appear on display.
2. Press the up or down arrows until "TONES ..." appears on the display.
3. Press "ENTER," and "RESTORE FACTORY DEFAULTS: NO" appears on the display.
4. Press the down arrow until "VOLUME: HIGH" appears on the display.
5. Press "ENTER" to change volume level. The current value will flash.
6. Use up and down arrows to select the desired volume level. Setting options are "HIGH", "LOW" and "OFF."
7. Press "ENTER" to confirm volume level setting.
8. To exit the Settings menu, press "SETTINGS."

Timeouts

Your oven is programmed with 4 preset timeouts that allow the user varying amounts of time to key in entries to the oven control display. The amount of time allowed the user to respond to a programming prompt is called a timeout. If the user fails to make an entry during the timeout period, the oven will default to its previous mode.

If you find that the amount of time allowed for programming does not meet your needs, you can redefine the limits of any of the four timeouts. The chart below defines the 4 timeouts, their duration, and when they're used:

	Description of Timeout	Used in...	Duration of Timeout
1	Short Entry	Cycle setpoint, meat probe setpoint, and setting the minute/second timer	5 seconds
2	Medium Entry	Entering cook/stop times, setting time, selecting functions and settings	10 seconds
3	Long Entry	Selecting, editing, and entering Recipes	30 seconds
4	Lock Key Hold Time	Locking the Oven	3 seconds

Oven Settings

To change the duration of a Timeout:

1. Press "SETTINGS". Settings menu will appear in display.
2. Press the up or down arrows until "TIMEOUTS..." appears in the display.
3. Press "ENTER" and "RESTORE FACTORY DEFAULTS": "NO" will appear on the display.
4. Scroll up or down using the arrow keys to find the timeout you would like to change and press "ENTER." Display will flash and appear as follows:

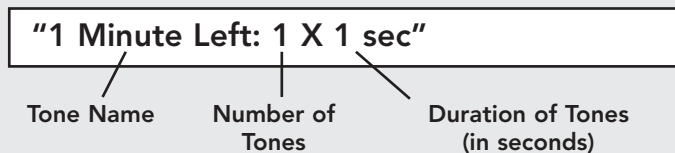

5. Using the numeric keyboard, enter the number of seconds desired.
6. Press "ENTER" when finished. Timeout is customized to your preference.
7. To exit the Settings menu, press "SETTINGS."

Clock Format

This feature allows users to choose a 12-hour or 24-hour format for the clock display.

To program the clock format:

1. Press "SETTINGS." Settings menu will appear in display.
2. Press up and down arrows until "12 or 24 HOURS: 12" appears in the display.
3. Press "ENTER" and the current setting will flash in the display.
4. Use arrow keys to choose "12" or "24."
5. Press "ENTER" again to accept desired clock format.
6. To exit the Settings menu, press "SETTINGS."
5. Push "SET" button.
6. Use the up arrow to toggle between "YES" and "NO".
7. Select "YES" and push "SET" button.
8. To exit the "SETTINGS" menu, press "SETTINGS".

Oven Settings

Sabbath Mode

This mode offers users belonging to religions with "no work" restrictions to program their ovens to comply with the Sabbath requirement. When the oven door is opened in Sabbath mode, the oven light stays off while the convection fan and heating elements remain on.

To program the Sabbath mode:

1. Press "SETTINGS". Settings menu will appear in display.
2. Press up or down arrows until "SABBATH: NO" appears in the display.
3. Press "ENTER," and "NO" will flash on display.
4. Use arrow keys to choose "YES" or "NO."
5. Press "ENTER" again to accept Sabbath mode.
6. To exit the Settings menu, press "SETTINGS."

Showroom Mode

This mode allows the oven to be hooked up to a 120 volt electrical supply for display or showroom mode purposes. In this mode, the electronic display/controls and oven lights will function but the heating elements and convection fan will NOT function.

To program the Showroom mode:

1. Press "SETTINGS". Settings menu will appear in display.
2. Use the down arrow to scroll to "TIMEOUTS".
3. At "TIMEOUTS" mode, hold the down arrow for 5 seconds.
4. Use the down arrow to scroll to "SHOWROOM".
5. Push "SET" button.
6. Use the up arrow to toggle between "YES" and "NO".
7. Select "YES" and push "SET" button.
8. To exit the "SETTINGS" menu, press "SETTINGS".

Oven Settings

Lock and Unlock



This feature prevents the control pads from being activated while the ovens are not being used.



To lock the ovens:

1. Press  on the right side of your oven control panel. Display shows "HOLD FOR LOCK."
2. When locked, three short beeps will sound and the display will show "PANEL IS LOCKED."
3. To unlock the oven, press and hold "UPPER OVEN" or "LOWER OVEN" for 3 seconds. When unlocked, two short beeps will sound and the display will show "PANEL IS UNLOCKED."

Interior Oven Lights (Two Pads)

Each oven has an interior light that can be turned off and on using the designated buttons on the oven control panel.

Press  or  to turn on the light in the upper or lower oven. (You will hear a beep to signal that the light is on.)

Press  or  again to turn off the light in the upper or lower oven. (You will hear two beeps to signal that the light is off.)

Recipe Function (Premiere Model Only)

Entering Recipe Name

This function programs and saves up to 100 cooking cycles from favorite recipes. Recipe names are entered on the numeric keypad on the right side of the keyboard.



When a key with several letters is pressed for the first time, the first letter is entered. If the same key is pressed a second time, the second letter is entered, and so on. For example, if the key "2 ABC" is pressed once, the letter 'A' is entered. If the key is pressed 2 times, the letter 'B' is entered. If the key is pressed 3 times, the letter 'C' is entered. If the key is pressed 4 times, the digit '2' is entered. Then lower case 'a', then 'b', then 'c', then 'A' again, and so on.

If nothing is pressed within 2 seconds, the cursor moves to the next position. To return to the previous position use the right "CLEAR" key. Pressing the '1' key will also move the cursor to the next position as well as entering a space.

When subsequent characters are entered, the case and type of the character matches the previous character. For example, if the previous character is a digit, then pressing the "2 ABC" key once would result in the digit '2'. If the previous character is a lower case letter, then pressing the "2 ABC" key once would result in the letter 'a'.

Recipe Function (Premiere Model Only)

Entering a new recipe

1. Hit "RECIPES" twice.
2. "NAME" should be flashing.
3. Enter a recipe name using numeric keypad.
4. Hit a Bake function key.
5. Use arrow or numeric keypad to set the temperature.
6. If needed, hit "COOK TIME" key to enter cook time.
7. Hit "SET" or "ENTER" to save the recipe.

Editing a recipe

1. In the recipe list mode, hit "RECIPES."
2. Recipe name should be flashing.
3. Use the following instructions to make changes:
 - To change recipe name, use numeric keypad.
 - To change cycle, press a Cycle key.
 - To change temperature, press an arrow key.
 - To change cook time, press the "COOK TIME" key.
4. Hit "SET" or "ENTER" to save the recipe.

Using a recipe

1. To use a programmed recipe, scroll through the list and press "ENTER" or "SET" to select and start the program.

Deleting a recipe

1. In the recipe list mode, hit "RECIPES."
2. Recipe name should be flashing.
3. Use right "CLEAR" key to erase the name.
4. Hit "SET" or "ENTER."

Warming Modes

Dehydrate

This oven is designed not only to cook, but also to dehydrate fruits and vegetables. Here are some tips for using your Viking oven's dehydrate feature:

1. Prepare the food as recommended.
2. Choose and press "UPPER OVEN" or "LOWER OVEN."
3. Arrange the food on drying racks (not included with the oven, but available from specialty cooking dealers).
4. Select "DEHYDRATE" from the oven function control panel.
5. Press "SET" or "ENTER." Dehydrate mode will begin immediately.

Defrost

This oven can defrost frozen food. To use the defrost function, take the following steps:

1. Place the frozen food on a baking sheet.
2. Choose and press "UPPER OVEN" or "LOWER OVEN."
3. Select "DEFROST" from the oven function control panel.
4. Press "SET" or "ENTER" to begin defrosting. The defrost mode will begin and the defrost temperature will be displayed.

WARNING

To avoid sickness and food waste, do not allow defrosted food to remain in the oven for more than two hours.

Proof

This function uses a low temperature between 90° and 110° F to create an optimal environment for the yeast to rise in many types of dough. To use the proof function, take the following steps:

1. Place the dough on a baking sheet.
2. Choose and press "UPPER OVEN" or "LOWER OVEN."
3. Select "PROOF" from the oven function control panel.
4. Press "SET" or "ENTER" to begin proofing.

Oven Off

The oven will continue operating until you press the "OFF" button for the oven you are using. For example, if you are cooking in the "UPPER OVEN," press the "OFF" button nearest this button on the control panel.

Bake Modes

Bake

This function is recommended for single-rack baking. Use this setting for baking, roasting, and casseroles. To bake, follow these steps:

1. Arrange the oven racks in the desired positions before heating the oven.
2. Select "UPPER OVEN" or "LOWER OVEN."
3. Set the Oven Function Selector to "BAKE." Temperature display flashes a preset temperature of 350° F.
4. Set the temperature using one of the following two methods:
 - a. Confirm preset temperature and press "SET" or "ENTER." The oven will begin Bake Preheat immediately.

OR

- b. Change the temperature by typing the desired temperature on the numeric keypad or using the up and down arrow keys. Press "SET" or "ENTER" when finished. The oven will begin Bake Preheat immediately.

During Bake Preheat

The display will alternate between showing the set baking temperature and the actual preheat temperature every 5 seconds. When the set baking temperature is reached, one long beep will sound and the display will show "BAKE." Open oven door and put food in oven.

To change set temperature during preheat stage:

	Press and Release
s	Temperature increases by 5° F (or 2° C)
t	Temperature decreases by 5° F (or 2° C)

Bake Modes

Convection Bake

This function is recommended for multi-rack baking. Foods can be baked and roasted at the same time with minimal taste transfer, even when different dishes are involved, such as cakes, fish, or meat. To use convection bake, take the following steps:

1. Arrange the oven racks in the desired positions before heating the oven.
2. Select "UPPER OVEN" or "LOWER OVEN."
3. Set the Oven Function Selector to "CONV. BAKE." Temperature display flashes a preset temperature of 325° F.
4. Set the temperature using one of the following two methods:
 - a. Confirm preset temperature and press "SET" or "ENTER." The oven will begin Conv. Bake Preheat immediately.

OR

- b. Change the temperature by typing the desired temperature on the numeric keypad or using the up and down arrow keys. Press "SET" or "ENTER" when finished. The oven will begin Conv. Bake Preheat immediately.

During Convection Bake Preheat

The display will alternate between showing the set baking temperature and the actual preheat temperature every 5 seconds. When the set baking temperature is reached, one long beep will sound and the display will show "CONV. BAKE." Open oven door and put food in oven.

To change set temperature during preheat stage:

	Press and Release
s	Temperature increases by 5° F (or 2° C)
t	Temperature decreases by 5° F (or 2° C)

Bake Modes

TruConvect™

This function is ideal for foods that require gentle cooking, single-rack baking, multiple-rack baking, roasting, and preparation of complete meals. This setting is also recommended when preparing large quantities of baked goods at one time. To use TruConvect™, take the following steps:

1. Arrange the oven racks in the desired positions before heating the oven.
2. Select "UPPER OVEN" or "LOWER OVEN."
3. Set the Oven Function Selector to "TRUCONVEC."
Temperature display flashes a preset temperature of 325° F.
4. Set the temperature using one of the following two methods:
 - a. Confirm preset temperature and press "SET" or "ENTER."
The oven will begin TruConvect™ Preheat immediately.

OR

- b. Change the temperature by typing the desired temperature on the numeric keypad or using the up and down arrow keys. Press "SET" or "ENTER" when finished. The oven will begin TruConvect™ Preheat immediately.

During TruConvect™ Preheat

The display will alternate between showing the set baking temperature and the actual preheat temperature every 5 seconds. When the set baking temperature is reached, one long beep will sound and the display will show "TRUCONVEC." Open oven door and put food in oven.

To change set temperature during preheat stage:

	Press and Release
s	Temperature increases by 5° F (or 2° C)
t	Temperature decreases by 5° F (or 2° C)

Broil Modes

Conventional broiling is most successful for cuts of meat one to two inches thick, and is also suitable for flat pieces of meat.

High Broil

With this setting, heat radiates at full power from both broil elements, located in the top of the oven cavity. The distance between the foods and the broil elements determines broiling speed. For fast broiling, place food as close as two inches from the broil element, or on the top rack. Fast broiling is best for meats where "rare to medium" doneness is desired. Use this setting for broiling small and average cuts of meat.

Medium Broil

With this setting, inner and outer broil elements pulse on and off to produce less heat for slow broiling. For slow broiling, allow about four inches between the top surface of your food and the broil element. Slow broiling is best for chicken and ham. Use this setting for broiling small and average cuts of meat.

Low Broil

This mode uses only a fraction of the oven's available power to the inner broil element to produce delicate top-browning in only three to four minutes on items such as meringue.

To Use Broil:

1. Arrange the oven rack in the desired position before turning the broiler on.
2. Place the food in the center of the cold broiler pan and grid supplied with your oven, and then place the broiler pan in the oven.
3. Select "UPPER OVEN" or "LOWER OVEN."
4. Set the Oven Function Selector to "BROIL." Display will show "BROIL HIGH" and "ON" will flash. Medium and low displays will show "CONV BROIL M" and "CONV BROIL L."
5. Choose power level for BROIL:
 - a. For "HIGH BROIL," press "SET."
 - b. For "MEDIUM BROIL," press down arrow key once. Display will change to MED, then press "SET."
 - c. For "LOW BROIL," press down arrow key twice. Display will change to LO, then press "SET."
6. Close the door to the oven. With closed-door broiling, the broil element might cycle on and off if an extended broiling time is required. A built-in smoke "eliminator" in the top of the oven will help reduce smoke and odors.
7. When cooking is complete, press the "OFF" button for the selected oven.

Broil Modes (cont.)

Convection Broil

Convection broiling has the advantage of broiling food slightly more quickly than conventional. Convection broiling of meats also produces better results, especially for thick cuts. This is because meat sears on the outside and retains more juices and natural flavor inside with less shrinkage.

To Use Convection Broil:

1. Arrange the oven rack in the desired position before turning the broiler on.
2. Place the food in the center of the cold broiler pan and grid supplied with your oven, and then place the broiler pan in the oven.
3. Select "UPPER OVEN" or "LOWER OVEN."
4. Set the Oven Function Selector to "CONV. BROIL." Display will show "CONV BROIL H" and "ON" will flash. Medium and low displays will show "CONV BROIL M" and "CONV BROIL L."
5. Choose power level for CONVECTION BROIL:
 - a. For "HIGH CONVECTION BROIL," press "SET."
 - b. For "MEDIUM CONVECTION BROIL," press down arrow key once. Display will change to MED, then press "SET."
 - c. For "LOW CONVECTION BROIL," press down arrow key twice.
 - d. Display will change to LO, then press "SET."
6. Close the door to the oven. With closed-door broiling, the broil element might cycle on and off if an extended broiling time is required. A built-in smoke "eliminator" in the top of the oven will help reduce smoke and odors.
7. When cooking is complete, press the "OFF" button for the selected oven.

Oven Off

The oven will continue operating until you press the "OFF" button for the oven you are using. For example, if you are cooking in the "UPPER OVEN," press the "OFF" button nearest this button on the control panel.

Roast Modes

Convection Roast

Use this function when roasting tender cuts of meat or poultry of any size. To use Convection Roast, follow these steps:

1. Arrange the oven racks in the desired positions before heating the oven.
2. Select "UPPER OVEN" or "LOWER OVEN."
3. Set the Oven Function Selector to "CONV. ROAST." Temperature display flashes a preset temperature of 325° F.
4. Set the temperature using one of the following two methods:
 - a. Confirm preset temperature and press "SET" or "ENTER." The oven will begin Convection Roast Preheat immediately.

OR

- b. Change the temperature by typing the desired temperature on the numeric keypad or using the up and down arrow keys. Press "SET" or "ENTER" when finished. The oven will begin Convection Roast Preheat immediately.

During Convection Roast Preheat

The display will alternate between showing the set temperature and the actual preheat temperature every 5 seconds. When the set temperature is reached, one long beep will sound and the display will show "CONV. ROAST." Open oven door and put food in oven.

To change set temperature during preheat stage:

	Press and Release
s	Temperature increases by 5° F (or 2° C)
t	Temperature decreases by 5° F (or 2° C)

Roast Modes

Auto Roast

Use this function to simplify roasting by automatically searing the outside of roasts. To use Auto Roast:

1. Arrange the oven racks in the desired positions before heating the oven.
2. Select "UPPER OVEN" or "LOWER OVEN."
3. Set the Oven Function Selector to "AUTO ROAST."
Temperature display flashes a preset temperature of 325° F.
4. Set the temperature using one of the following two methods:
 - a. Confirm preset temperature, press "SET" or "ENTER." The oven will begin TruConvect™ Preheat immediately.

OR

- b. Change the temperature by typing the desired temperature on the numeric keypad or using the up and down arrow keys. Press "SET" or "ENTER" when finished. The oven will begin TruConvect™ Preheat immediately.

During Auto Roast Preheat

The display will alternate between showing the set roasting temperature and the actual preheat temperature every 5 seconds.

When Set Auto Roast Temperature Is Reached

One long beep will sound and the display will show "SEARING." The oven will remain at searing temperature (set temperature plus 100° F) for 30 minutes. If set, the Cook Time timer will begin.

To Turn Off Oven:

Press the "OFF" button on the control panel display for the oven you are using. One beep will sound and the oven will turn off.

Meat Probe (Available on Premiere Models)

The meat probe takes the guesswork out of roasting by cooking foods to the ideal internal temperature. The probe setting is used to automatically turn the oven off when meat reaches its optimal internal temperature. Your Viking oven's built-in probe will help you prepare meats exactly as you want them.

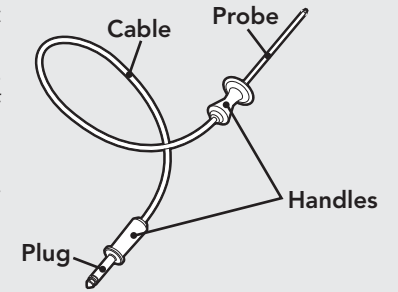

Meat Probe Use and Care

- Use of probes other than the one provided with your oven may result in damage to the probe.
- Use the handles of the probe and plug when inserting and removing them from the meat and outlet.
- To avoid damaging your probe, never use tongs to pull on the cable when removing.
- To avoid breaking the probe, make sure food is completely defrosted before inserting.
- To prevent possible burns, do not unplug the probe from the outlet until the oven has cooled.
- Never leave the probe inside the oven during a self-cleaning cycle.
- Never store the probe inside the oven.

To Insert the Meat Probe:

After preparing the meat and placing it on the broiler pan, follow these steps for proper probe placement:

1. Lay the probe on the outside of the meat along the top or side and use your finger to mark where the edge of the meat meets the probe. The point where they meet should rest in the center of the thickest, meatiest part of the roast.
2. Insert the probe completely into the meat. It should not touch the bone, fat, or gristle.
 - For roasts with no bone, insert the probe into the meatiest part of the roast.
 - For bone-in ham or lamb, insert the probe into the center of the lowest large muscle or joint.
 - With a whole turkey, insert the probe into the meatiest part of the inner thigh from below and parallel to the leg.

Meat Probe (Available on Premiere Models)

To Set the Meat Probe Function:

- A cooking mode must be selected before setting meat probe.
- Bake, Convection Bake, Convection Roast, TruConvect™, and Convection Broil are the cooking modes that can be used with the meat probe function.
- Set the internal temperature about 10° F lower than the actual desired internal temperature. The meat will continue to cook when removed from the oven and will reach desired internal temperature while "standing."

1. Insert probe into the meat and slide into oven after the oven has reached the set preheat temperature. Double oven models have a meat probe in the upper oven only.
2. Plug the probe into the outlet located on the left interior wall of the oven and close the oven door.
3. Press the "MEAT PROBE" button on the control panel. The display will show "SET PROBE" and flashing preset temperature.
4. The preset temperature of 160° F or a stored temperature will be displayed on the electronic timing center. If you desire this temperature, the probe mode will begin after 10 seconds.
5. To set another temperature, use the keypad to enter the desired temperature and press "SET" or "ENTER."
 - The temperature must be within the range of 120° to 190° F.
 - Display alternates between cook mode and probe temperature.
 - Probe temperature displays LO until 100° F is reached, then displays actual temperature.
6. When the probe is within 10° F of setpoint, two long beeps will sound. When the setpoint is reached, three long beeps will sound and the oven will turn off. The display will alternate between cook mode and "DONE." One short beep will sound every minute until the probe function is closed.
7. Press any key to close the probe function.

Cooking Tips

Rack Positions

Each oven is equipped with three tilt-proof racks. Premiere models have two standard tilt-proof racks and one TruGlide™ rack. With the TruGlide™ rack, the bottom section remains in the oven and the top section smoothly glides outward when pulled. This reduces the chances of spills from items that contain juice or liquid. This rack can be used in any of the six rack positions.

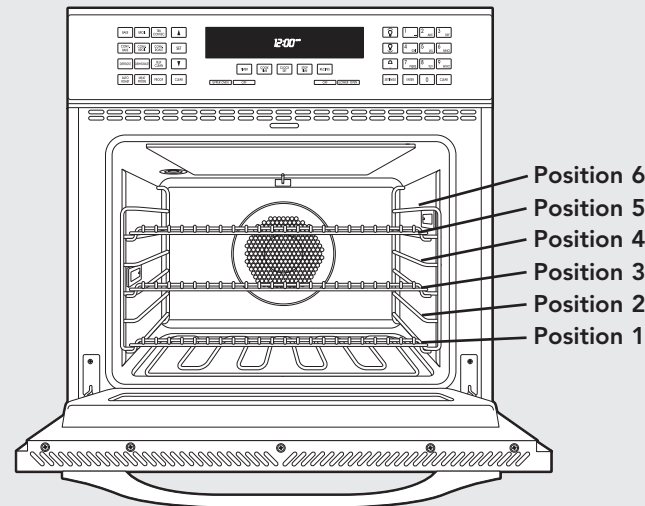

All ovens have six rack positions. Position 6 is the farthest from the oven bottom. Position 1 is the closest to the oven bottom. The racks can be easily removed and arranged at various levels. For best results with conventional baking, do not use more than one rack at a time. It is also recommended, when using two racks, to bake with the racks in positions 2 and 4 or positions 3 and 5.

1. Arrange the oven racks in the desired positions BEFORE heating the oven. If cooking on two racks at the same time, use rack positions 2 and 4 or positions 3 and 5.
2. Turn the Oven Function selector to desired function. Cooking starts immediately and stops when the Oven Function selector is turned to OFF.
3. Set the Temperature Control to the desired temperature.
4. Place food in the oven after the Oven indicator light goes out.

Cooking Tips

Pan Placement Tips

- When using large (15" x 13") flat pans or trays that cover most of the rack, rack positions 2 or 3 produce the best results.
- When baking on more than one rack, we recommend using one of the convection modes and the 2nd and 4th position or the 3rd and 5th position for more even baking. When baking on three racks, use any combination of positions 2, 3, 4, and 5 for more consistent results.
- Stagger pans in opposite directions when two racks and several pans are used in Conventional Bake Mode. If possible, no pan should be directly above another.
- Allow 1 to 2 inches of air space around all sides of each pan for even air circulation.

Single Rack Pan Placement

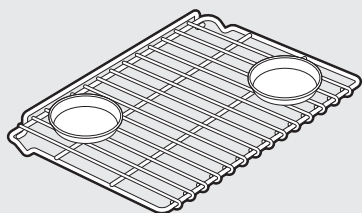

Multiple Rack Pan Placement

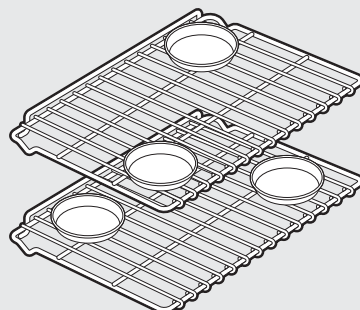

Baking Tips

Because of variations in food density, surface texture, and consistency, some foods may be prepared more successfully using the Conventional Bake setting. For this reason, conventional baking is recommended when preparing baked goods, such as custard. You may find that other foods also turn out best when cooked in Conventional Bake Mode.

- As a general rule, to convert conventional recipes to convection recipes, reduce the temperature by 25° F (-3.9° C) and the cooking time by approximately 10 to 15%.

Cooking Tips

- Some recipes may require adjustment and testing when converting from standard to convection modes. If unsure how to convert a recipe, begin by preparing the recipe in Conventional Bake. After achieving acceptable results, follow the convection guidelines listed for the similar food type. If the food is not prepared to your satisfaction during this first convection trial, adjust only one recipe variable at a time (cooking time, rack position, or temperature) and repeat the convection test. Continue adjusting one recipe variable at a time until you achieve the results you are looking for.
- Make sure the oven racks are in the desired position before you turn on the oven.
- Do not open the door frequently during baking. Look through the door window to check doneness whenever possible. If you must open the door, the best time is during the last quarter of the baking time.
- Bake to the shortest time suggested and check for doneness before adding more time. For baked goods, a stainless steel knife placed in the center of the product should come out clean when the baked item is done.
- Use the pan size and type recommended by the recipe to ensure best results. Cakes, quick breads, muffins, and cookies should be baked in shiny, reflective pans for light, golden crusts. Avoid the use of old, darkened pans. Warped, dented, stainless steel and tin-coated pans heat unevenly and will not give uniform baking results.

Multiple Rack Baking

One major benefit of convection cooking is the ability to prepare foods in larger quantities. The uniform air circulation makes this possible. Foods that can be prepared on two or three racks at the same time include: pizza, cakes, cookies, biscuits, muffins, rolls, and frozen convenience foods.

For three-rack baking, use any combination of rack positions two, three, four, and five. For two-rack baking, use rack positions two and four or positions three and five. Remember that the racks are numbered from bottom to top.

Conventional Baking Chart

Food	Pan Size	Single Rack Position	Temp	Time (minutes)
BREADS				
Biscuits	Cookie Sheet	3 or 4	400° F (204.4° C)	8 - 10
Yeast Loaf	Loaf Pan	3 or 4	375° F (190.6° C)	30 - 35
Yeast Rolls	Cookie Sheet	3 or 4	400° F (204.4° C)	12 - 15
Nut Bread	Loaf Pan	3 or 4	375° F (190.6° C)	30 - 35
Cornbread	8" x 8"	3 or 4	400° F (204.4° C)	20 - 25
Gingerbread	8" x 8"	3 or 4	350° F (176.7° C)	35 - 40
Muffins	Muffin Tin	3 or 4	375° F (190.6° C)	15 - 20
Corn Muffins	Muffin Tin	3 or 4	375° F (190.6° C)	15 - 20
CAKES				
Angel food	Tube pan	3 or 4	375° F (190.6° C)	35 - 45
Bundt	Tube pan	3 or 4	350° F (176.7° C)	45 - 55
Cupcakes	Muffin pan	3 or 4	350° F (176.7° C)	16 - 20
Layer, Sheet	13" x 9"	3 or 4	350° F (176.7° C)	40 - 50
Layer, Two	9" round	3 or 4	350° F (176.7° C)	30 - 35
Pound	Loaf pan	3 or 4	350° F (176.7° C)	60 - 65
COOKIES				
Brownies	13" x 9"	3 or 4	350° F (176.7° C)	25 - 30
Choc. Chip	Cookie Sheet	3 or 4	375° F (190.6° C)	12 - 15
Sugar	Cookie Sheet	3 or 4	350° F (176.7° C)	10 - 12
PASTRY				
Cream Puffs	Cookie Sheet	3 or 4	400° F (204.4° C)	30 - 35
PIES				
Crust, Unfilled	9" Round	3 or 4	425° F (218.3° C)	10 - 12
Crust, Filled	9" Round	3 or 4	375° F (190.6° C)	55 - 60
Lemon Meringue	9" Round	3 or 4	350° F (176.7° C)	12 - 15
Pumpkin	9" Round	3 or 4	350° F (176.7° C)	40 - 45
Custard	6 - 4 oz cups	3 or 4	350° F (176.7° C)	35 - 40
ENTREES				
Egg Rolls	Cookie Sheet	3 or 4	400° F (204.4° C)	12 - 15
Fish Sticks	Cookie Sheet	3 or 4	425° F (218.3° C)	18 - 21
Lasagna, frz	Cookie Sheet	3 or 4	375° F (190.6° C)	65 - 70
Pot Pie	Cookie Sheet	3 or 4	400° F (204.4° C)	35 - 40
Gr. Peppers Stuffed	13" x 9"	3 or 4	375° F (190.6° C)	65 - 70
Quiche	9" Round	3 or 4	400° F (204.4° C)	25 - 30
Pizza, 12"	Cookie Sheet	3 or 4	400° F (204.4° C)	15 - 20
Mac. & Cheese, frz	Cookie Sheet	3 or 4	375° F (190.6° C)	60 - 65
VEGETABLES				
Baked Potatoes	On Rack	3 or 4	375° F (190.6° C)	60 - 65
Spinach Souffle	1 qt. Casserole	3 or 4	350° F (176.7° C)	45 - 50
Squash	Cookie Sheet	3 or 4	375° F (190.6° C)	50 - 55
French Fries	Cookie Sheet	3 or 4	425° F (218.3° C)	15 - 20

Convection Baking Chart

Food	Pan Size	Single Rack Position	Temp	Time (minutes)
BREADS				
Biscuits	Cookie Sheet	2 & 4	375° F (190.6° C)	7 - 9
Yeast Loaf	Loaf Pan	2 & 4	350° F (176.7° C)	20 - 25
Yeast Rolls	Cookie Sheet	2 & 4	375° F (190.6° C)	11 - 13
Nut Bread	Loaf Pan	2 & 4	350° F (176.7° C)	20 - 25
Cornbread	8" x 8"	2 & 4	375° F (190.6° C)	15 - 20
Gingerbread	8" x 8"	2 & 4	325° F (162.8° C)	30 - 35
Muffins	Muffin Tin	2 & 4	350° F (176.7° C)	12 - 15
Corn Muffins	Muffin Tin	2 & 4	350° F (176.7° C)	0 - 12
CAKES				
Angel food	Tube pan	3 or 4	325° F (162.8° C)	30 - 35
Bundt	Tube pan	3 or 4	325° F (162.8° C)	35 - 40
Cupcakes	Muffin pan	2 & 4	325° F (162.8° C)	15 - 17
Layer, Sheet	13" x 9"	2 & 4	325° F (162.8° C)	30 - 32
Layer, Two	9" round	2 & 4	325° F (162.8° C)	25 - 30
Pound	Loaf pan	2 & 4	325° F (162.8° C)	5 - 50
COOKIES				
Brownies	13" x 9"	2 & 4	325° F (162.8° C)	20 - 25
Choc. Chip	Cookie Sheet	2,3,& 4	350° F (176.7° C)	7 - 10
Sugar	Cookie Sheet	2,3,& 4	325° F (162.8° C)	9-10
PASTRY				
Cream Puffs	Cookie Sheet	2 & 4	375° F (190.6° C)	4 - 27
PIES				
Crust, Unfilled	9" Round	2 & 4	400° F (204.4° C)	7 - 9
Crust, Filled	9" Round	2 & 4	350° F (176.7° C)	50 - 55
Lemon Meringue	9" Round	2 & 4	325° F (162.8° C)	4 - 5
Pumpkin	9" Round	2 & 4	325° F (162.8° C)	35 - 45
Custard	6 - 4oz cups	2 & 4	325° F (162.8° C)	30 - 35
ENTREES				
Egg Rolls	Cookie Sheet	2 & 4	375° F (190.6° C)	8 - 10
Fish Sticks	Cookie Sheet	2 & 4	400° F (204.4° C)	13 - 16
Lasagna, frz	Cookie Sheet	2 & 4	350° F (176.7° C)	60 - 65
Pot Pie	Cookie Sheet	2 & 4	375° F (190.6° C)	10 - 12
Gr. Peppers Stuffed	13" x 9"	2 & 4	350° F (176.7° C)	45 - 50
Quiche	9" Round	2 & 4	375° F (190.6° C)	20 - 25
Pizza, 12"	Cookie Sheet	2 & 4	375° F (190.6° C)	10 - 12
Mac. & Cheese, frz	Cookie Sheet	3 or 4	350° F (176.7° C)	45 - 50
VEGETABLES				
Baked Potatoes	On Rack	3 or 4	350° F (176.7° C)	45 - 50
Spinach Souffle	1 qt. Casserole	3 or 4	325° F (162.8° C)	35 - 40
Squash	Cookie Sheet	3 or 4	350° F (176.7° C)	40 - 45
French Fries	Cookie Sheet	3 or 4	400° F (204.4° C)	10 - 15

Solving Baking Problems

Baking problems can occur for many reasons. It is important to remember that the temperature setting and cooking times you are accustomed to using with your previous oven may vary slightly from those required with your new Viking oven. You may find that you need to make some adjustments.

COMMON BAKING PROBLEMS AND REMEDIES

PROBLEM	CAUSE	REMEDY
Cakes burned on the sides or not done in center	<ol style="list-style-type: none"> 1. Oven was too hot 2. Wrong pan size 3. Too many pans 	<ol style="list-style-type: none"> 1. Reduce temperature 2. Use recommended pan size 3. Reduce number of pans
Cakes crack on top	<ol style="list-style-type: none"> 1. Batter too thick 2. Oven too hot 3. Wrong pan size 	<ol style="list-style-type: none"> 1. Follow recipe; Add liquid 2. Reduce temperature 3. Use recom. pan size
Cakes are not level	<ol style="list-style-type: none"> 1. Batter uneven 2. Oven or rack not level 3. Pan was warped 	<ol style="list-style-type: none"> 1. Distribute batter evenly 2. Level oven or rack 3. Use proper pan
Food too brown on bottom	<ol style="list-style-type: none"> 1. Oven door opened too often 2. Dark pans being used 3. Incorrect rack position 4. Wrong bake setting 5. Pan too large 	<ol style="list-style-type: none"> 1. Use door window to check food 2. Use shiny pans 3. Use recom. rack position 4. Adjust to conventional or convection setting as needed 5. Use proper pan
Food too brown on top	<ol style="list-style-type: none"> 1. Rack position too high 2. Oven not preheated 3. Sides of pan too high 	<ol style="list-style-type: none"> 1. Use recom. rack position 2. Allow oven to preheat 3. Use proper pans
Cookies too flat	<ol style="list-style-type: none"> 1. Hot cookie sheet 	<ol style="list-style-type: none"> 1. Allow sheet to cool between batches
Pies burned around edges	<ol style="list-style-type: none"> 1. Oven too hot 2. Too many pans used 3. Oven not preheated 	<ol style="list-style-type: none"> 1. Reduce temperature 2. Reduce no. of pans 3. Allow oven to preheat
Pies too light on top	<ol style="list-style-type: none"> 1. Oven not hot enough 2. Too many pans used 3. Oven not preheated 	<ol style="list-style-type: none"> 1. Increase temperature 2. Reduce no. of pans 3. Allow oven to preheat

Broiling Tips

- Always use a broiler pan and grid for broiling. They are designed to provide drainage of excess liquid and fat away from the cooking surface to help prevent splatter, smoke, and fire.
- To keep meat from curling, slit fatty edges.
- Brush chicken and fish with butter several times as they broil to prevent drying out.
- To prevent sticking, lightly grease broiler tray.
- Broil on first side for slightly more than half the recommended time, season, and then turn. Season the second side just before removing from the oven.
- Always pull the rack out to "STOP" position before turning or removing food.
- Use tongs or a spatula to turn meats. Never pierce meat with a fork, as this allows the juices to escape.
- Remove the broiler pan from the oven when you remove the food. Otherwise, drippings will bake onto the pan.
- While the pan is hot, place a damp paper towel over the grid. Drizzle with liquid dishwashing detergent and pour water over the grid. This will make cleaning easier.
- You can also line the broiler pan with aluminum foil to make cleaning easier. Be sure the foil extends up the side of the pan.
- Although it isn't recommended, the grid can also be covered with foil. Be sure to slit openings to conform with the openings in the grid so that melted fat can drain through. This will prevent spattering, smoking, or the possibility of grease fire.

Broiling Chart

Type and Cut of Meat	Weight	Setting	Rack	Time (minutes)
BEEF				
Sirloin, 1"				
Rare	12 oz	Conventional Broil	5	7
Medium	12 oz	Conventional Broil	5	9
Well done	12 oz	Conventional Broil	5	11
T-Bone, 3/4"				
Rare	10 oz	Conventional Broil	5	5
Medium	10 oz	Conventional Broil	5	7
Well done	10 oz	Conventional Broil	5	9
Hamburger, 1/2"				
Rare	1/4 lb.	Convection Broil	5	4
Medium	1/4 lb.	Convection Broil	5	7
Well done	1/4 lb.	Convection Broil	5	9
CHICKEN				
Bnls Breast	1 lb.	Convection Broil	4	18
Bone-in Breast	2 - 2 1/2 lb.	Conventional Broil	4	20
Chicken pieces	2-2 1/2 lb.	Convection Broil	4	18 (min/lb)
HAM				
Ham slice, 1"	1 lb.	Conventional Broil	4	22
PORK				
Rib Chops, 1"	12 oz.	Convection Broil	5	7
Shoulder	1 lb.	Convection Broil	5	6
FISH				
Salmon Steak	1 lb.	Convection Broil	5	7
Fillet	1 lb.	Convection Broil	5	6

Roasting Tips

- Always use the broiler pan and grid supplied with each oven, because the hot air must be allowed to circulate around the item being roasted.
- Do not cover what is being roasted; convection roasting seals in juices quickly for a moist, tender product. Poultry will have a light, crispy skin and meats will be browned, not dry or burned.
- Cook meats and poultry directly from the refrigerator. There is no need for meat or poultry to stand at room temperature.
- As a general rule, to convert conventional recipes to convection recipes, reduce the temperature by 25° F (-3.9° C) and the cooking time by approximately 10 to 15%.
- Always roast meats fat side up in a shallow pan, using a roasting rack. No basting is required when the fat side is up.
- Do not add water to the pan, as this will cause a steamed effect. Roasting is a dry-heat process.
- Poultry should be placed breast side up on a rack in a shallow pan. Brush poultry with melted butter, margarine, or oil before and during roasting.
- For convection roasting, do not use pans with tall sides, as this will interfere with the circulation of heated air over the food.
- When using a meat thermometer, insert the probe halfway into the center of the thickest portion of the meat. (For poultry, insert the thermometer probe between the body and leg into the thickest part of the inner thigh.) To ensure an accurate reading, the tip of the probe should not touch bone, fat, or gristle.
- Check the meat temperature halfway through the recommended roasting time.
- After reading the thermometer once, insert it 1¼ to 2 inches (1.3 cm) further into the meat, then take a second reading. If the second temperature registers below the first, continue cooking the meat.
- Roasting times always vary according to the size, shape, and quality of meats and poultry. Less tender cuts of meat are best prepared in the conventional bake setting and may require moist cooking techniques.
- Remove roasted meats from the oven when the thermometer registers 5° F (-15° C) to 10° F (-12.2° C) lower than the desired doneness. This is because the meat will continue to cook after removal from the oven.
- Allow roasts to stand 15 to 20 minutes after taking them out of the oven to make carving easier.
- If using a cooking bag, foil tent, or other cover, use the conventional bake setting rather than either convection setting.

Conventional Roasting Chart

Food	Weight	Temp	Time (min/lb)	Internal Temp
BEEF				
Rib Roast				
Rare	4 - 6 lbs	325° F (162.8° C)	25	140° F (60.0° C)
Medium	4 - 6 lbs	325° F (162.8° C)	30	155° F (68.3° C)
Well done	4 - 6 lbs	325° F (162.8° C)	40	170° F (76.7° C)
Rump Roast				
Medium	4 - 6 lbs	325° F (162.8° C)	25	155° F (68.3° C)
Well done	4 - 6 lbs	325° F (162.8° C)	30	170° F (76.7° C)
Tip Roast				
Medium	3 - 4 lbs	325° F (162.8° C)	35	155° F (68.3° C)
Well done	3 - 4 lbs	325° F (162.8° C)	40	170° F (76.7° C)
LAMB				
Lamb Leg	3 - 5 lbs	325° F (162.8° C)	30	180° F (82.2° C)
PORK				
Pork Loin	3 - 5 lbs	325° F (162.8° C)	35	180° F (82.2° C)
Pork Chops 1" thick	1 - 1 1/4 lbs	350° F (176.7° C)	55 - 60 total time	N/A
Ham, fully Cooked	5 lbs	325° F (162.8° C)	18	130° F (54.4° C)
POULTRY				
Chicken, Whole	3 - 4 lbs	375° F (190.6° C)	30	180° F (82.2° C)
Turkey, Unstuffed	12 - 16 lbs	325° F (162.8° C)	16 - 20	180° F (82.2° C)
Turkey	20 - 24 lbs	325° F (162.8° C)	16 - 20	180° F (82.2° C)
Turkey, Stuffed	12 - 16 lbs	325° F (162.8° C)	17 - 21	180° F (82.2° C)
Turkey, Stuffed	20 - 24 lbs	325° F (162.8° C)	17 - 21	180° F (82.2° C)
Turkey Breast	4 - 6 lbs	325° F (162.8° C)	20	180° F (82.2° C)

Convection Roasting Chart

Food	Weight	Temp	Time (min/lb)	Internal Temp
BEEF				
Rib Roast				
Rare	4 - 6 lbs	325° F (162.8° C)	25	140° F (60.0° C)
Medium	4 - 6 lbs	325° F (162.8° C)	24	155° F (68.3° C)
Well done	4 - 6 lbs	325° F (162.8° C)	30	170° F (76.7° C)
Rump Roast				
Medium	4 - 6 lbs	325° F (162.8° C)	20	155° F (68.3° C)
Well done	4 - 6 lbs	325° F (162.8° C)	24	170° F (76.7° C)
Tip Roast				
Medium	3 - 4 lbs	325° F (162.8° C)	30	155° F (68.3° C)
Well done	3 - 4 lbs	325° F (162.8° C)	35	170° F (76.7° C)
LAMB				
Lamb Leg	3 - 5 lbs	325° F (162.8° C)	30	180° F (82.2° C)
PORK				
Pork Loin	3 - 5 lbs	325° F (162.8° C)	30	180° F (82.2° C)
Pork Chops 1" thick	1 - 1 1/4 lbs	325° F (162.8° C)	45 - 50 total time	N/A
Ham, fully Cooked	5 lbs	325° F (162.8° C)	15	130° F (54.4° C)
POULTRY				
Chicken, Whole	3-4 lbs	350° F (176.7° C)	25	180° F (82.2° C)
Turkey, Unstuffed	12 - 16 lbs	325° F (162.8° C)	11	180° F (82.2° C)
Turkey	20 - 24 lbs	325° F (162.8° C)	11	180° F (82.2° C)
Turkey, Stuffed	12 - 16 lbs	325° F (162.8° C)	9 - 10	180° F (82.2° C)
Turkey, Stuffed	20 - 24 lbs	325° F (162.8° C)	9 - 10	180° F (82.2° C)
Turkey Breast	4 - 6 lbs	325° F (162.8° C)	20	180° F (82.2° C)

Cleaning and Maintenance

Any piece of equipment works better and lasts longer when maintained properly and kept clean. Cooking equipment is no exception. Your new Viking oven must be kept clean and maintained properly in order to give you the years of cooking enjoyment for which it is designed.

Several different finishes have been used in your electric oven. Cleaning instructions for each surface are given below. (Your oven features a Self-Clean cycle for the oven interior. See page 52 for complete interior cleaning instructions.)

General Cleaning

NOTE: NEVER USE AMMONIA, STEEL WOOL PADS OR ABRASIVE CLOTHS, CLEANSERS, OVEN CLEANERS, OR ABRASIVE POWDERS ON ANY PART OF YOUR VIKING OVEN. THEY CAN CAUSE PERMANENT DAMAGE.

Surface or Feature	Cleaning Recommendation
Brass Parts	<ul style="list-style-type: none"> • Clean the broiler pan and grid with detergent and hot water. For stubborn spots, use a soap-filled, steel wool pad. • Clean the oven racks with detergent and hot water. Stubborn spots can be scoured with a soap-filled, steel wool pad.
Broiler Pan and Grid	<ul style="list-style-type: none"> • Clean the broiler pan and grid with detergent and hot water. • Scour stubborn spots with a soap-filled, steel wool pad.

Cleaning and Maintenance

Surface or Feature	Cleaning Recommendation
Meat Probe	<ul style="list-style-type: none"> • Cool the probe before cleaning. • The meat probe may be cleaned with soap and water or with a soap-filled scouring pad. • Scour stubborn spots with the soap-filled scouring pad. Rinse and dry. • Do not immerse the meat probe in water. • Do not store the probe inside the oven.
Oven Control Panel	<ul style="list-style-type: none"> • The panel and its individual TouchSensor™ panels should be cleaned regularly. • Wipe clean with a soft cloth and any glass cleaner or mild detergent.
Stainless Steel Parts	<ul style="list-style-type: none"> • All stainless steel body parts should be wiped regularly with hot, soapy water at the end of each cooling period, and with a liquid cleaner designed for steel when soapy water will not do the job. • Do not use steel wool, abrasive cloths, cleansers, or powders. • If necessary, soak the area with hot towels to loosen encrusted material, then use a wooden or nylon spatula or scraper. Do not use a metal knife, spatula, or any other metal tool to scrape stainless steel. • Do not permit citrus or tomato juice to remain on any stainless steel surface, because citric acid will permanently discolor stainless steel. Wipe up any spills.

CAUTION

All special ordered brass parts are coated with an epoxy coating. DO NOT USE BRASS CLEANERS OR ABRASIVE CLEANERS ON ANY BRASS PARTS. All brass body parts should be wiped regularly with hot soapy water. When hot soapy water will not do the job, use every day household cleaners that are not abrasive.

Cleaning and Maintenance

Cleaning the Interior Oven

Your Viking oven features an automatic, self-cleaning cycle. During this cycle, the oven reaches elevated temperatures in order to burn off soil and deposits. An integral smoke eliminator helps reduce odors associated with the soil burn-off. A powder ash residue is left in the bottom of the oven after completion of the Self-Clean Cycle.

The door latch is automatically activated after selecting the Self-Clean setting. The latch ensures that the door cannot be opened while the oven interior is at clean temperatures.

Before Using the Self-Clean Cycle:

- Remove the oven racks and any other items/utensils from the oven. The high heat generated during the cleaning cycle can discolor, warp, and damage these items.
- Do not use foil or liners in the oven during the Self-Clean Cycle.
- Wipe off any large spills from the oven bottom and sides.
- Never use oven cleaners inside a self-cleaning oven or on raised portions of the oven door.
- Some areas of the oven must be cleaned by hand before the cycle begins. Soils in these areas will be baked on and very difficult to clean if not removed first.
- Clean the door up to the gasket, the door frame, and up to two inches inside the frame with detergent and hot water. Rinse thoroughly and dry.
- Clean only the parts listed in this manual.

WARNING

Burn or Electrical Shock Hazard

Make sure all controls are OFF and oven is COOL before cleaning. Failure to do so can result in burns or electrical shock.

Cleaning and Maintenance

Using the Self-Clean Cycle

1. Close the door completely.
2. Select "UPPER OVEN" or "LOWER OVEN." "SELECT MODE" will appear in the display for the selected oven.
3. Press "SELF CLEAN" from the oven function control panel.
4. Press "SET" or "ENTER." At this time, "SELF CLEAN" will appear in the display. The door lock indicator light will remain on until the Self-Clean is completed or interrupted and the oven temperature drops to a safe temperature. A complete cycle takes approximately 3 1/2 hours, with an additional 30 minutes needed for the oven to cool down enough for the door latch to disengage.
NOTE: A whirring fan noise will be heard during the Self-Clean Cycle and will continue to run for the 3 1/2 hour duration of the Self-Clean Cycle.
5. The timer will count down from 4 hours. When the cycle is completed, press the "OFF" button for the selected oven.
6. When the oven has completely cooled, open the door and remove any ash from the oven surfaces with a damp cloth.
7. To cancel or interrupt the self-cleaning cycle, press the "OFF" button for the selected oven.

CAUTION

Do not touch the exterior portions of the oven after self-cleaning cycle has begun, since some parts become extremely hot to the touch! During the first few times the self-cleaning feature is used, there may be some odor and smoking from the curing of the binder in the high-density insulation used in the oven. When the insulation is thoroughly cured, this odor will disappear. During subsequent self-cleaning cycles, you may sense an odor characteristic of high temperatures. Keep the kitchen well-ventilated during the self-cleaning cycle.

Replacing Light

Replacing Interior Halogen Oven Lights

⚠ CAUTION
 DISCONNECT THE ELECTRIC POWER AT THE MAIN FUSE OR CIRCUIT BREAKER BEFORE REPLACING BULB.

Do not touch bulb with bare hands. Clean off any signs of oil from the bulb and handle with a soft cloth.

1. Unsnap glass light cover using a screwdriver in the access groove.
2. Firmly grasp light bulb and pull out.
3. Replace with halogen bulb using volt and wattage requirements listed on glass cover.
4. Replace the light cover by snapping glass cover onto metal box.
5. Reconnect power at the main fuse or circuit breaker.

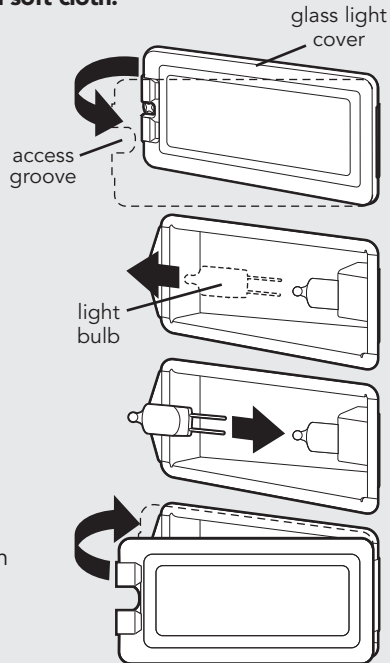

Power Failure

Do not attempt to use during a power failure. Unit will not function.

Trouble Shooting

PROBLEM	POSSIBLE CAUSE AND/OR REMEDY
1. Oven will not function.	Oven is not connected to electrical power. Have electrician check power circuit breaker, wiring and fuses.
2. Oven does not operate in self-clean mode.	Door is not shut tight enough for automatic door latch to lock.
3. Door will not open.	Oven is still in Self-Clean Mode. If oven is hot, door latch will release when a safe temperature is reached.
4. Oven light will not work.	Light bulb is burned out. Oven is not connected to power.

Error Handling

In the event that you make an error while programming your Viking oven, you will hear a long beep followed by the appearance of an error message on the display. Use the following key to help you correct these common programming errors:

Error Message	Problem	Correction
MODEL ERROR	An incorrect model number has been installed.	Call your Viking dealer or authorized service agency.
RTD ERROR	RTD is open or shorted.	Call your Viking dealer or authorized service agency.
PROBE ERROR	The meat probe is open or shorted.	The meat probe may not be plugged in. If it isn't, plug it in to the oven. Press the OFF key to exit and clear the error message. If the meat probe is plugged in and the Error message is still displayed, call your Viking dealer or authorized service agency.
LATCH ERROR	The control is unable to lock or unlock the door latch.	Call your Viking dealer or authorized service agency.
KEYBOARD ERROR	No connection exists between the keyboard and control.	Call your Viking dealer or authorized service agency.

Service Information

If your oven should fail to operate, check to see whether the circuit breaker is open or the fuse is blown.

If service is required, call your Viking dealer or authorized service agency. The name of the authorized service agency can be obtained from the Viking dealer or distributor in your area.

When you call for service, have the following information readily available:

- Model number
- Serial number
- Date of purchase
- Name of dealer from whom purchased

Be ready to clearly describe the problem that you are having with your Viking oven.

If you are unable to obtain the name of an authorized service agency, or if you continue to have service problems, contact Viking at (888) 845-4641 or write to:

VIKING PREFERRED SERVICE
111 Front Street
Greenwood, Mississippi 38930 USA

Record the following information indicated below. You will need it if service is ever required. The serial number and model number for your oven are located on the identification plate mounted on the bottom left side of the oven door opening.

Model Number _____ Serial Number _____

Date of Purchase _____ Date Installed _____

Dealer's Name _____

Address _____

If service requires installation of parts, use only authorized parts to ensure protection under the warranty.

This manual should remain with the oven for future reference.

Warranty

BUILT-IN ELECTRIC OVENS WARRANTY ONE YEAR FULL WARRANTY

Built-in electric ovens and all of their component parts and accessories, except as detailed below*, are warranted to be free from defective materials or workmanship in normal household use for a period of twelve (12) months from the date of original retail purchase. Viking Range Corporation, warrantor, agrees to repair or replace, at its option, any part which fails or is found to be defective during the warranty period.

*Glass (including light bulbs), painted and decorative items are warranted to be free from defective materials or workmanship for a period of ninety (90) days from the date of original retail purchase. ANY DEFECTS MUST BE REPORTED TO THE SELLING DEALER WITHIN NINETY (90) DAYS FROM DATE OF ORIGINAL RETAIL PURCHASE.

Viking Range Corporation uses the most up-to-date processes and best materials available to produce all color finishes. However, slight color variation may be noticed because of the inherent differences in painted parts and porcelain parts as well as differences in kitchen lighting, product locations, and other factors.

FIVE YEAR LIMITED WARRANTY

Any bake element, broil element, or convection cook element which fails due to defective materials or workmanship in normal household use during the second through fifth year from the date of original retail purchase will be repaired or replaced, free of charge for the part itself, with the owner paying all other costs, including labor.

TEN YEAR LIMITED WARRANTY

Any porcelain oven or porcelain inner door panel which rusts through due to defective materials or workmanship in normal household use during the second through the tenth year from the date of original retail purchase will be repaired or replaced, free of charge for the part itself, with the owner paying all other costs, including labor.

NINETY (90) DAY RESIDENTIAL PLUS WARRANTY This warranty applies to applications where use of the product extends beyond normal residential use. Examples are, but not limited to, bed and breakfasts, fire stations, private clubs, churches, etc. This warranty excludes all commercial locations such as restaurants, food service locations and institutional food service locations.

This warranty extends to the original purchaser of the product warranted hereunder and to each transferee owner of the product during the term of the warranty.

This warranty shall apply to products purchased and located in the United States and Canada. Products must be purchased in the country where service is requested. Warranty labor shall be performed by an authorized Viking Range Corporation service agency or representative. Warranty shall not apply to damage resulting from abuse, accident, natural disaster, loss of electrical power to the product for any reason, alteration, outdoor use, improper installation, improper operation, or repair or service of the product by anyone other than an authorized Viking Range Corporation service agency or representative. This warranty does not apply to commercial usage. Warrantor is not responsible for consequential or incidental damage whether arising out of breach of warranty, breach of contract, or otherwise. Some jurisdictions do not allow the exclusion or limitation of incidental or consequential damages, so the above limitation or exclusion may not apply to you.

Owner shall be responsible for proper installation, providing normal care and maintenance, providing proof of purchase upon request, and making the appliance reasonably accessible for service. If the product or one of its component parts contains a defect or malfunction during the warranty period, after a reasonable number of attempts by the warrantor to remedy the defects or malfunctions, the owner is entitled to either a refund or replacement of the product or its component part or parts. Warrantor's liability on any claim of any kind, with respect to the goods or services covered hereunder, shall in no case exceed the price of the goods or service or part thereof which gives rise to the claim.

WARRANTY SERVICE: Under the terms of this warranty, service must be performed by a factory authorized Viking Range Corporation service agent or representative. Service will be provided during normal business hours, and labor performed at overtime or premium rates shall not be covered by this warranty. To obtain warranty service, contact the dealer from whom the product was purchased, an authorized Viking Range Corporation service agent, or Viking Range Corporation. Provide model and serial number and date of original purchase. For the name of your nearest authorized Viking Range Corporation service agency, call the dealer from whom the product was purchased or Viking Range Corporation. **IMPORTANT:** Retain proof of original purchase to establish warranty period.

The return of the Owner Registration Card is not a condition of warranty coverage. You should, however, return the Owner Registration Card so that Viking Range Corporation can contact you should any question of safety arise which could affect you.

Any implied warranties of merchantability and fitness applicable to the above described bake element, broil element, convection cook element, porcelain oven, or porcelain inner door panel are limited in duration to the period of coverage of the applicable express written limited warranties set forth above. Some jurisdictions do not allow limitations on how long an implied warranty lasts, so the above limitation may not apply to you. This warranty gives you specific legal rights, and you may also have other rights which may vary from jurisdiction to jurisdiction.

