



All Prestige venting systems feature infinite speed blower control with whisper-quiet performance.



Prestige Ventilation Inserts Include:

- Commercial Grade 304 SS Construction
- Dishwasher Safe SS Baffle Filters
- Variable Speed Fan Control
- Halogen Lamps with Dimmer Control
- Large Capture Area
- Quiet Performance
- For use with custom wood hoods, mantles, arches, alcoves, and stucco formed hoods.

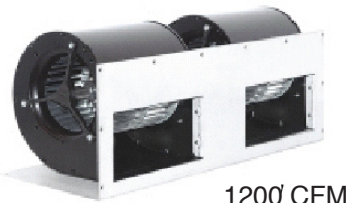

1200 CFM



600 CFM

Internal Blowers

Prestige offers several blower options for your hood to properly fit the custom application unique to your home. Quiet, powerful, and efficient, the Internal Blowers range from 600 CFM to 1200 CFM.

Power Pack Hood Inserts Available Models

<u>UIB22-S1</u>	<u>22"W x 12"D x 10"H - 600CFM, 2 Lights</u>
<u>UIB28-S1</u>	<u>28"W x 15"D x 14"H - 600CFM, 2 Lights</u>
<u>UIB34-S1</u>	<u>34"W x 15"D x 14"H - 600CFM, 2 Lights</u>
<u>UIB34-S2</u>	<u>34"W x 15"D x 14"H - 1200CFM, 2 Lights</u>
<u>UIB40-S2</u>	<u>40"W x 15"D x 14"H - 1200CFM, 2 Lights</u>
<u>UIB46-S2</u>	<u>46"W x 18"D x 14"H - 1200CFM, 3 Lights</u>
<u>UIB52-S2</u>	<u>52"W x 18"D x 14"H - 1200CFM, 3 Lights</u>
<u>UIB58-S2</u>	<u>58"W x 18"D x 14"H - 1200CFM, 3 Lights</u>

**2 Motors - UIB34, 40, 46, 52, 58S2 TF34, 40, 46S2
Custom Size Available Upon Request - Transition
Required with 1200CFM Blowers - TR6x15/8**

Electrical Requirements - 600 CFM, 1100 CFM, & 1200 CFM - 15 Amps at 120 volts
All Inserts can be made Duct Free with a DFK - Duct Free Kit

Hood Insert Specifications Guide (S Models)

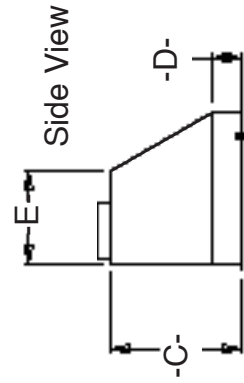

Additional Information:

- Electrical connection is located in the center of the back of the unit 4" from the base.
- Single Duct exit is 6" Round.
- Ducting Recommendation for S1 Models: For Duct Run 10' or less 6" Round Duct. For Duct Run over 10' use 8" Round Duct. Transition included. For S2 Models: For Duct Run 10' or less 8" Round Duct. Over 10' use 10" Round Duct.

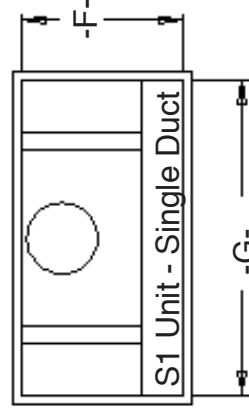
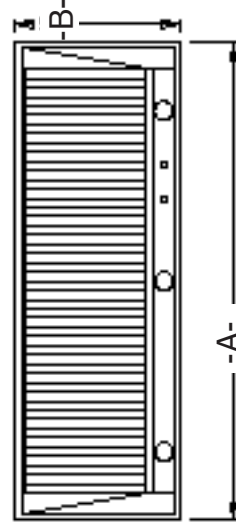
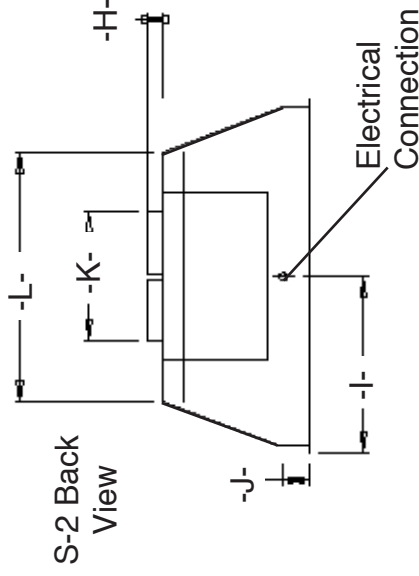
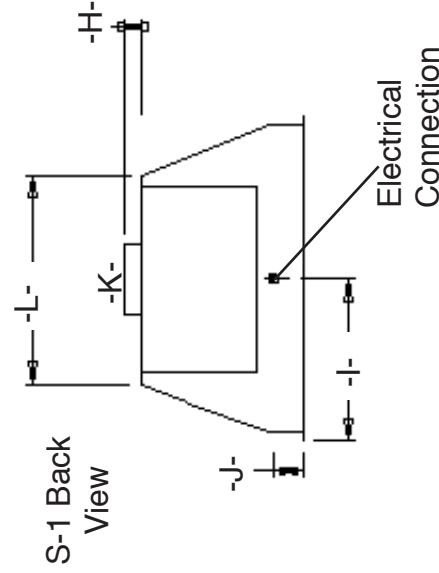
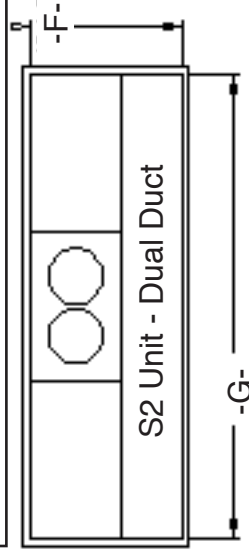

Box Dimensions Overall minus flange

Box Dimensions Overall minus flange

Model	A	B	C	D	E	F	G	H	I	J	K	L	Cutout Dimension	Transition Size
22-S1	22	12	11	3	8 1/2	10 1/2	25 1/4	1 1/2	5	2 1/2	6	12 1/2	20 5/8 x 10 5/8	INCLUDED**
28-S1	28	15	14	3	10	13 1/2	31 1/4	1 1/2	14	2 1/2	6	18	25 3/4 x 13 5/8	INCLUDED**
34-S1	34	15	14	3	10	13 1/2	31 1/4	1 1/2	17	2 1/2	6	24	31 3/4 x 13 5/8	INCLUDED**
34-S2	34	15	14	3	10	13 1/2	31 1/4	1 1/2	17	2 1/2	12 1/2	24	31 3/4 x 13 5/8	TR6x15/8 or /10
40-S2	40	15	14	3	10	13 1/2	37 1/4	1 1/2	20	2 1/2	12 1/2	30	37 3/4 x 13 5/8	TR6x15/8 or /10
46-S2	46	18	14	3	10	16 1/2	44 3/4	1 1/2	23	2 1/2	12 1/2	20	45 1/4 x 16 5/8	TR6x15/8 or /10
52-S2	52	18	14	3	10	16 1/2	50 3/4	1 1/2	26	2 1/2	12 1/2	26	51 1/4 x 16 5/8	TR6x15/8 or /10
58-S2	58	18	14	3	10	16 1/2	56 3/4	1 1/2	29	2 1/2	12 1/2	32	57 1/4 x 16 5/8	TR6x15/8 or /10