

# Service Manual for Cuber Model CS0415



## Introduction

---

This is the service manual for the CS0415 ice machine.

Note and heed any warning symbols where they appear.

Basic installation information is provided, however the installation manual is separate.

## Table of Contents

|  |         |
|--|---------|
| Specifications . . . . .                       | Page 3  |
| Installation: . . . . .                        | Page 4  |
| Test Mode - Ice Thickness Adjustment . . . . . | Page 5  |
| Technical Charts: . . . . .                    | Page 6  |
| Operational Modes: . . . . .                   | Page 7  |
| Harvest Mode . . . . .                         | Page 8  |
| Component Location . . . . .                   | Page 9  |
| Component Location . . . . .                   | Page 10 |
| Diagnostic Mode . . . . .                      | Page 11 |
| Error Displays . . . . .                       | Page 12 |
| Component Testing . . . . .                    | Page 13 |
| Component Testing . . . . .                    | Page 14 |
| Flow Chart - Overall Operation . . . . .       | Page 15 |
| Flow Chart - Freeze Mode Details . . . . .     | Page 16 |
| Service Diagnosis . . . . .                    | Page 17 |
| Service Diagnosis . . . . .                    | Page 18 |
| Removal and Replacement - Thermistor . . . . . | Page 19 |
| Removal and Replacement . . . . .              | Page 20 |
| Removal and Replacement - Controller . . . . . | Page 21 |
| Removal and Replacement . . . . .              | Page 22 |
| Removal and Replacement - Evaporator . . . . . | Page 23 |

## Specifications

---

Scotsman Ice Systems are designed and manufactured with the highest regard for safety and performance. They meet or exceed the standards of agencies like NSF and UL..

Scotsman assumes no liability or responsibility of any kind for products manufactured by Scotsman that have been altered in any way, including the use of any part and/or other components not specifically approved by Scotsman.

Scotsman reserves the right to make design changes and/or improvements at any time. Specifications and design are subject to change without notice.

AC Power Supply:

- 104 to 127 VAC (rated 115 VAC), 60 Hz

Amperage:

- 6.5 Amps (max)

Minimum Circuit Capacity:

- 15 Amps

Ice Production per 24 hours (Approximate)

- 70°F (27°C) 46 lbs (21 kg)
- 80°F (27°C) 47 lbs (21 kg)
- 90°F (32°C) 40 lbs (18 kg)
- 100°F (38°C) 40 lbs (18 kg)

Ice Shape:

- 3/4" x 3/4" Square

Ice Thickness @ Normal Setting (Approximate)

- 0.32" or 5/16" (8.1 mm)

Ice Thickness @ Thin Setting (Approximate)

- 0.28" or 9/32" (7.0 mm)

Ice Thickness @ Thick Setting (Approximate)

- 0.39" or 3/8" (9.9 mm)

Storage Capacity (Approximate)

- 24 lbs. (10.9 kg)

Exterior Dimensions (W x D x H)

- 15" x 24" x 34" (381 or 457.2 x 609.6 x 863.6 mm)

Exterior Finish:

- Painted Steel

Net Weight:

- 94 lb. (42.6 kg)

Cube Thickness Control:

- Thermistor under Evaporator & Control Board Setting

Harvest Control:

- Thermistor under Evaporator & Control Board Setting

Bin Ice Level Control:

- Thermistor on side of Bin

Refrigerant:

- R-134a (6.2 oz). Weigh into high side only.

Ambient Temperature Operation Range:

- 55 to 100°F

Water Pressure Operating Range

- 20 to 120 psig

Water Consumption (Dependent On Water Pressure)

- 6 to 10 gallons per 4 hours

## Installation:

The ice machine is designed to be installed indoors, in a controlled environment. Do not place where the temperature limits for air or water are exceeded.

The water supply must be cold, potable water. A drain must be nearby or a drain pump model used or a gravity drain model must be converted to use a drain pump.

The ice machine must be on its own electrical power circuit. The machine must be grounded. Do not connect to an extension cord. Do not cut off the ground prong off the power cord plug. Do not bypass the ground prong.

The cabinet is designed to be either free standing or built in. In either case the area in front of the kickplate must be free of obstruction. Blocking this area will cause low ice capacity and likely damage the machine. Such damage is considered mis-use and is not covered by warranty.

When building into a cabinet, be sure the power supply, water and drain are all available within the built in area.

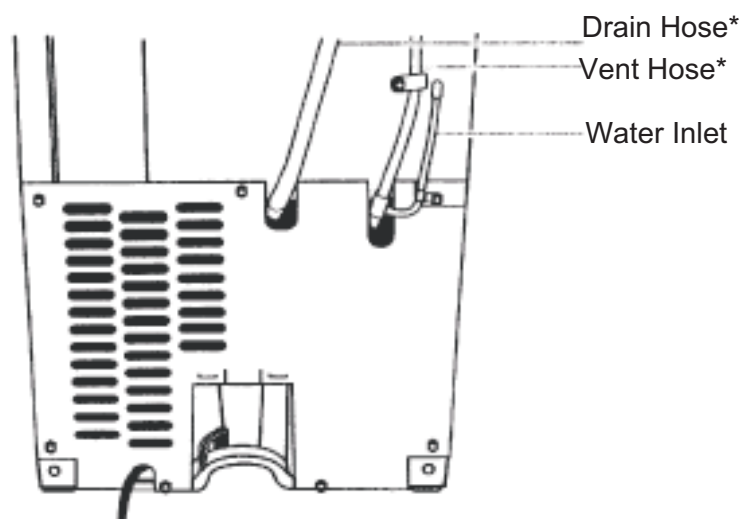

*Back View*

\* Drain Pump Models

## Test Mode - Ice Thickness Adjustment

---

The CS0415 has three push button switches: ON, OFF and CLEAN. These can be used to switch the machine on, off and to start the cleaning process. They can also be used to test the unit's components.

To test and/or to adjust ice thickness:

1. Unplug or disconnect the unit from the power supply.

---

Note: Unit must be On (make ice mode) when power is disconnected.

---

2. Reconnect power to the unit.

3. Immediately, within ten seconds of power re-connection, push and hold the On and Clean buttons until the three indicator lights begin to blink.

4. Push and release the On button to cycle through testing the various components.

---

Note: 10 push-and-releases will switch the controller to ice thickness adjustment mode.

---

Pre-Test Mode: All 3 lights are on steady.

Test 1, testing the bin thermistor. The On light is the indicator, if it is on steady, it is OK. If it blinks twice and repeats, it is open. If it blinks 4 times and repeats, it is shorted.

Test 2, testing the evaporator thermistor. The Clean light is the indicator, if it is on steady, it is OK. If it blinks twice and repeats, it is open. If it blinks 4 times and repeats, it is shorted.

Test 3, testing the inlet water valve. Four minute test.

Test 4, testing the water level sensor.

Test 5, testing the water pump.

Test 6, Testing the reservoir drain pump.

Test 7, testing the compressor and condenser fan motor.

Test 8, testing the compressor and hot gas valve.

Test 9, no component tested.

Test 10, displaying the ice thickness setting.

### Ice Thickness Adjustment.

The Off light is the indicator.

- If it blinks 2 times and repeats, the ice thickness is set at thin.
- If it blinks 4 times and repeats, the ice thickness is set at normal.
- If it blinks 6 times and repeats, the ice thickness is set at thick.

Pushing and releasing the Clean button between flashes adjusts the thickness setting to the next one.

**Technical Charts:**

Bin Thermistor

|     | Cut-In         |                    | Cut-Out       |                   |
|-----|----------------|--------------------|---------------|-------------------|
|     | Temperature    | Resistance         | Temperature   | Resistance        |
| Bin | 40°F. +/- 1°F. | 25.9k ohms +/- 3 % | 35°F +/- 1°F. | 29.8 ohms +/- 3 % |

Evaporator Thermistor

|               | End Harvest Readings |                  |
|---------------|----------------------|------------------|
| Ice Thickness | Temperature          | Resistance       |
| Normal        | 52°F. +/- 3%         | 18.7k ohms +/-1% |
| Thick         |                      |                  |
| Thin          |                      |                  |

Other Technical Information

|                      | Wattage @ 120 V | Resistance  |
|----------------------|-----------------|-------------|
| Compressor           | 244             |             |
| Run                  |                 | 1 - 5       |
| Start                |                 | 3 - 11      |
| Water pump           | 7.5             | 3.6         |
| Reservoir drain pump | 4.5             | 3.6         |
| Water valve          | 20              |             |
| Hot gas valve        | 7 - 9           | 385         |
| Bin thermistor       |                 | 10k @ 77°F. |
| Evap thermistor      |                 | 10k @ 77°F. |
| Transformer          | 73              |             |
| Fan motor            | 5.1 - 7.1       | 185         |
| Cutter grid          |                 | 20          |

## Operational Modes:

There are four main operational modes for the ice maker:

- Freeze
- Harvest
- Clean
- Service (Diagnostics)

### Ice Making Cycle

In addition, there are three possible “Off” cycles for the ice maker. They occur when:

1. The bin is full of ice and the LED is illuminated “ON/OFF” (Idle mode).
2. The “On/OFF” control switch has been held for three seconds. The ON/OFF LED will go out.

## Electrical System

Line Voltage is supplied to the electrical control switches and the primary side of the step-down dual transformer. The dual transformer reduces 120 VAC to **8.75 VAC for the cutter grid** and the bin light and **12 VAC for the drain and recirculating pumps**. The electronic control board directs 12 VAC to the water recirculating and reservoir drain pumps, and 120 VAC to the hot gas solenoid, condenser fan motor, and compressor. The measured fill water valve will always have 120 VAC on the BK and WH wires and 14 VDC on the OR/WH and BK/RD wires.

An evaporator thermistor supplies temperature information to the electronic control to determine when to terminate the harvest cycle.

## Refrigeration System

The hot gas refrigerant, under high pressure, is forced through the condenser, where it changes into a liquid, and flows through the drier and capillary tube into the evaporator. Under low pressure in the evaporator, the liquid refrigerant absorbs heat from the water flowing over the evaporator as the refrigerant evaporates into a gas. As a low pressure gas, the refrigerant flows back through the suction line of the heat exchanger, to the compressor.

During the Freeze mode, some of the hot gas that is in the condenser accumulating tube, condenses to a liquid, and remains in the accumulating tube.

During the later stages of the Freeze mode, as the ice slab forms on the evaporator freezing plate, some of the refrigerant passing through the evaporator will not evaporate into a gas, but will remain a liquid. This liquid refrigerant will settle in the accumulator, while the refrigerant vapor is sucked off through the suction tube at the top of the accumulator. This accumulated liquid refrigerant will eventually be directed to the evaporator to quickly warm the evaporator plate during the Harvest mode.

---

Note: It is very important that the accumulator is not tilted out of a horizontal position. If moved, it could cause compressor failure.

---

## Water System

The water recirculating pump moves the water from the reservoir pan up to the distributor, where it flows out over the evaporator freezing plate.

Water that does not freeze on the evaporator plate runs off the front edge, and falls back into the reservoir, where it is recirculated back to the water distributor.

As the ice slab forms, the minerals in the water are on the surface of the ice. The water flowing over the top of the ice slab washes these minerals back into the water reservoir pan. The water continues to recirculate until the water level in the reservoir drops to the bottom of the water level sensor. When the water level in the reservoir drops below the sensor, the control terminates the freeze mode and initiates the harvest mode.

The control signals the measured fill valve to fill to the selected water level setting. The measured fill valve uses a flow meter to accurately fill to the correct volume.

- Thin Ice uses 32 ounces (954cc),
- Normal Ice 37 ounces (1106cc), and
- Thick Ice 42.5 ounces (1258cc).

## Harvest Mode

---

### Electrical System

When the water level in the reservoir drops below the water level sensor it signals the electronic control to terminate power to the condenser fan, and then the water recirculating pump. The reservoir drain pump is activated to fully drain the reservoir. Power is then supplied to the hot gas valve and a fill request is sent to the measured fill valve. The fill valve fills to the requested volume while the hot gas valve is energized for the balance of the harvest mode.

If the evaporator thermistor is unplugged, the evaporator defaults to a timed 4 minute harvest.

If the water level sensor is disconnected or open, the control defaults to 25 minutes of freeze time. The cleaning indicator LED feature will not function if the water level sensor is disconnected.

### Refrigeration System

The hot gas valve opens, allowing high pressure refrigerant gas to bypass the condenser, and flow through the condenser accumulating tube. The hot gas pushes the liquid refrigerant that has accumulated in the accumulator tube up into the evaporator. The hot liquid refrigerant evenly heats the evaporator plate so that the ice slab releases quickly and evenly.

The ice slab, when released, slides off of the evaporator plate onto the cutter grid.

### Water System

The electronic control board sends a signal to the water valve. The signal tells the water valve how much water to be filled, allowing water to flow into the water reservoir pan. The water fill volume is determined by the ice thickness setting.

As a result of the hot gas flow and the ice sliding off the evaporator plate, the evaporator temperature begins to rise. When the evaporator thermistor reaches the set temperature (52°F), the unit switches to the Freeze mode. This cycling between Freeze and Harvest, continues until the ice bin is full.

The electronic control board operates the various components and systems in the ice maker for each of the Freeze and Harvest modes.

## Clean Mode

### Electrical System

The electronic control board operates the various components and systems during the Clean mode.

### Water System

When the service control switch is in the "Clean" position, the water pump circulates the cleaning solution that has been added to the reservoir, up to the water distributor, across the evaporator, and back into the reservoir, where it is recirculated. The compressor and hot gas valve operate to heat the evaporator.



## Component Location

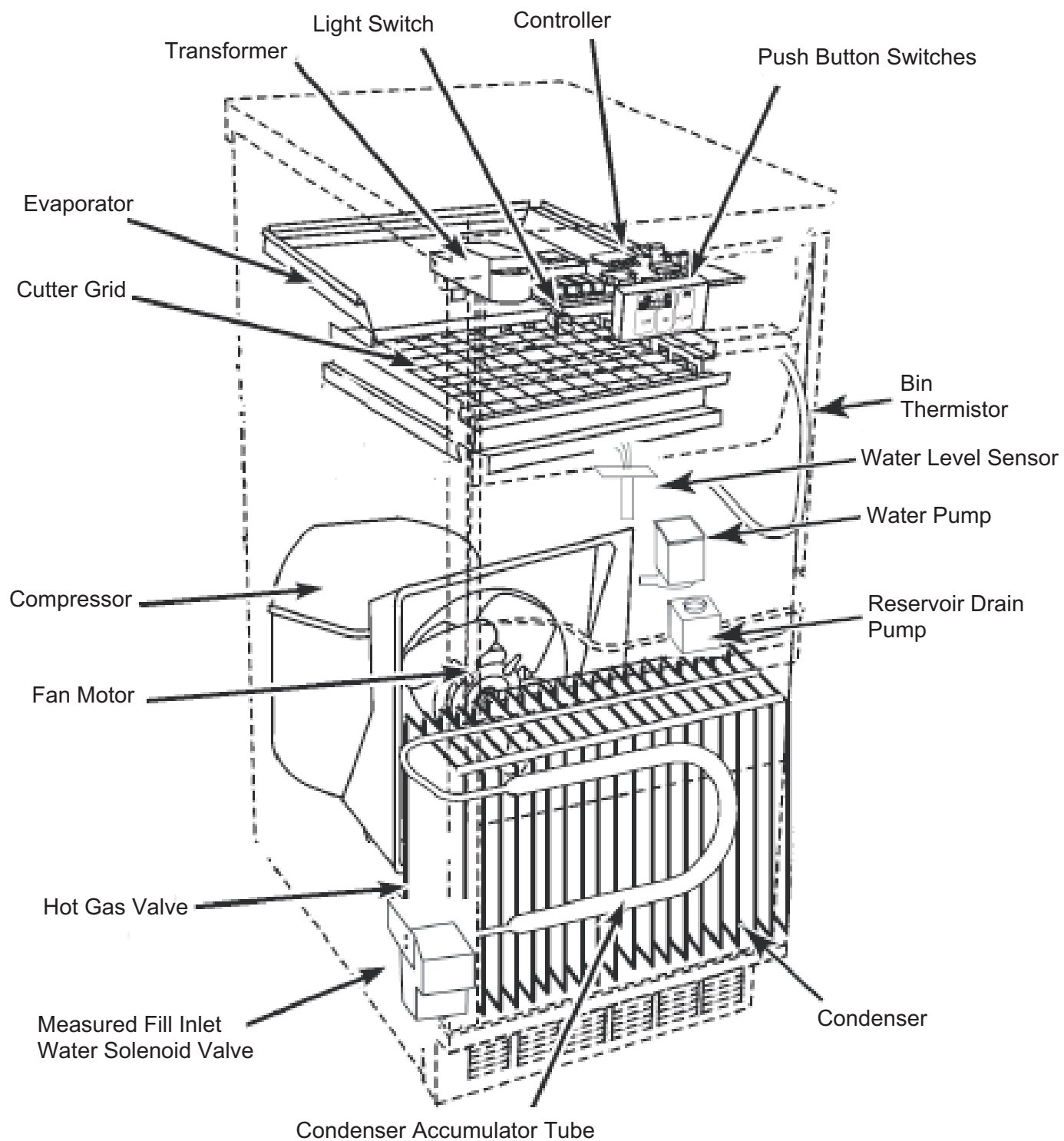

Component Location

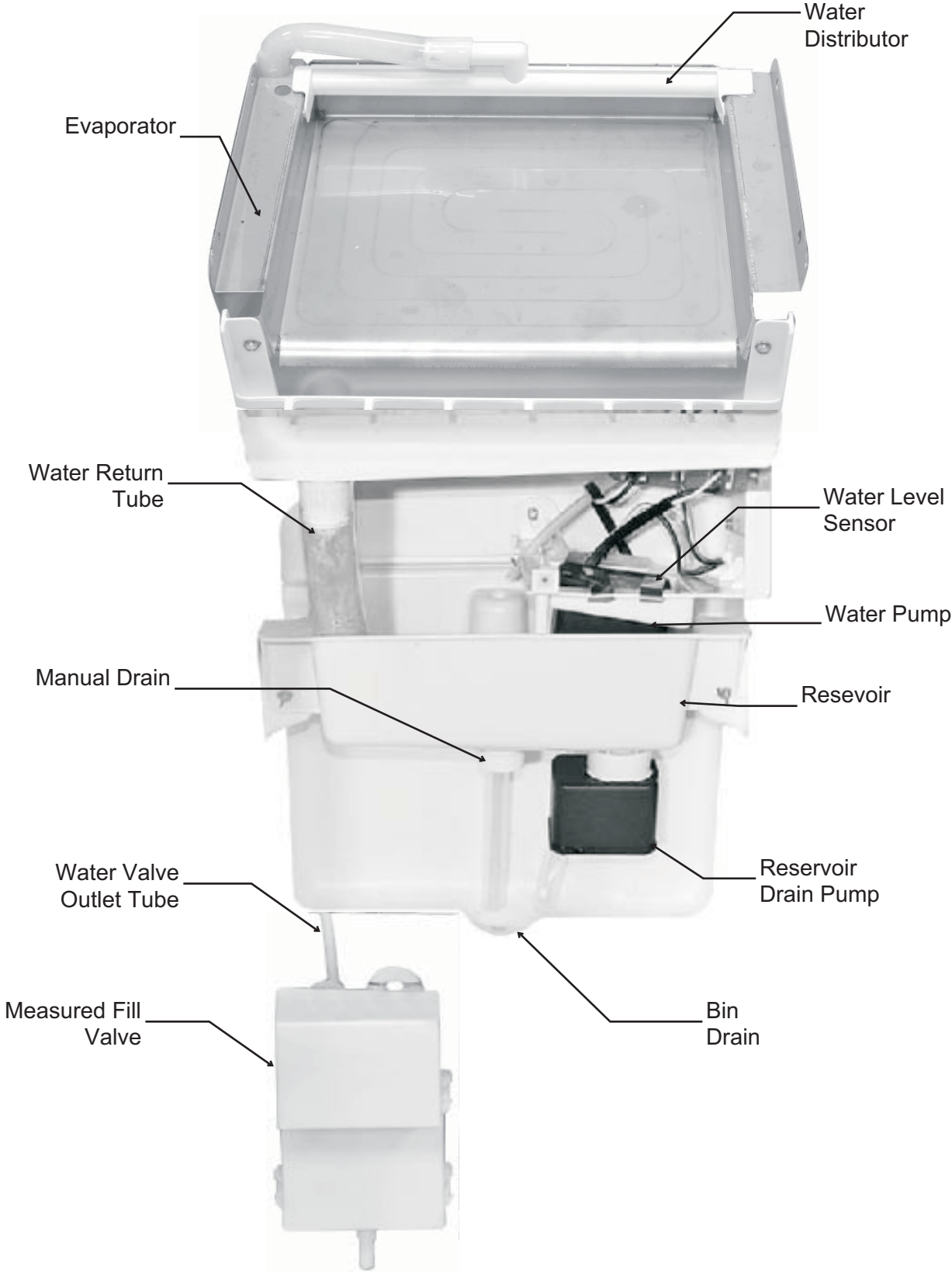

## Diagnostic Mode

Do not continue with the diagnosis of the ice maker if a fuse is blown, a circuit breaker is tripped, or if there is less than a 120 volt power supply at the wall outlet. Units that failed during the first few days of use should be checked for loose connections or miswiring.

### Entering and Navigating — Manual Diagnostics

Turn the product to On. Within 10 seconds of Power On, press and hold the On and the Clean buttons. Release both buttons when all user interface LEDs begin to flash.

Within 5 seconds of all LEDs flashing, push any other button (On, Off, or Clean). This begins manual diagnostics. If no button is pressed within 5 seconds, the product goes into an automatic diagnostic mode. Each component is cycled for 5 seconds.

The Off button is used to advance through each step. To exit manual diagnostics, press the On button.

After pressing any button to enter manual diagnostics all LEDs will illuminate for 5 seconds. The controls will then automatically move to the first component.

| Order | Component  | On LED  | Off LED  | Clean LED                                    |
|-------|--|---|--|--|
| 1     | Entry into Test Mode   | ON  | ON   | ON   |
| 2     | Bin Thermistor   | ON Solid—OK. 2 blinks—Open. 4 blinks—Shorted. | OFF  | OFF  |
| 3     | Evaporator Thermistor  | OFF   | OFF  | ON Solid—OK<br>2blinks—Open<br>4blinks—Short |
| 4a    | Water Valve 4 min time out Off button press will advance to step 6 | OFF   | ON Solid—reservoir full<br>Blinking—reservoir empty  | ON   |
| 4b    | Water Level Sensor   | OFF   | ON Solid—reservoir full<br>Blinking—reservoir empty  | ON   |
| 5     | Water Pump   | ON  | ON   | ON   |
| 6     | Reservoir Drain Pump   | ON  | OFF  | OFF  |
| 7     | Compressor and Condenser Fan Motor                                 | ON Solid while cooling                        | Blinking when evap thermistor reaches 4.5°F; full frost pattern should be visible            | ON   |
| 8     | Compressor and Hot Gas Valve                                       | ON Solid while heating                        | ON Solid while heating<br>Blinking when evap thermistor reaches 52°F                         | ON Solid while heating                       |
| 9     | None   | Off   | Off  | On is normal*                                |
| 10    | Ice Thickness  | OFF   | 2 Blinks—Thin. 4 Blinks—Normal. 6 Blinks—Thick. Press Clean button to cycle between settings | OFF  |

## Error Displays

---

These errors will occur at any time during normal operation if a thermistor fails.

- **2 Blinks** - Off Light is blinking twice in repeating intervals – This signals a bin thermistor failure. Check that the bin thermistor is plugged in to the control box. Check that the bin thermistor is not open or shorted. Replace the thermistor if it is open or shorted.
- **3 Blinks**- Off Light is blinking three times in repeating intervals – This signals a harvest failure. Check that the evaporator thermistor is connected to the sealed system tubing. If the thermistor is plugged in, ensure that it is fully connected to the control box. (The ice maker will operate on a timed cycle if the evaporator thermistor is unplugged.) Check the resistance of the thermistor. If the thermistor checks good, then look for a frost pattern on the evaporator plate. The unit may be low on refrigerant.

---

Note: The lights will continue to blink after correction until the unit is shut off and then switched back on.

---

The power cord on the internal drain pump is connected to a 120 VAC wall outlet. The ice maker is then connected to the 120 VAC outlet on the drain pump. If the drain pump fails, or if the drain becomes blocked, power is shut off to the 120 VAC outlet on the drain pump.

When the unit is first plugged in, the drain pump will run for 20 seconds. The power can be disconnected and reconnected to verify that the pump is operating properly.

Water from the ice maker reservoir, or melting ice from the bin, drains down the bin drain tube into the pump inlet, and then into the drain pump chamber. As the water level rises, it bridges the “full” contacts, and the pump starts to run. The pump discharges the water through the outlet and the check valve. When the “full” connection is removed, the pump runs for an additional 12 seconds to empty the tank.

If the water level in the drain pump continues to rise, due to a slow or blocked drain, or a blocked vent hose, and touches the “overflow” contact, power will be turned off to the drain pump’s 120 VAC outlet, causing the ice maker to turn off.

## Component Testing

Before testing any of the components, perform the following checks:

- Control failure can be the result of corrosion on connectors. Therefore, disconnecting and reconnecting wires will be necessary throughout test procedures.
- All tests/checks should be made with a VOM or DVM having a sensitivity of 20,000 ohms per- volt DC, or greater.
- Check all connections before replacing components, looking for broken or loose wires, failed terminals, or wires not pressed into connectors far enough.
- Resistance checks must be made with power cord unplugged from outlet, and with wiring harness or connectors disconnected.

|  |   |
|--|---|
| <b>⚠ WARNING</b>   |  |
| <b>Electrical Shock Hazard</b><br>Electrical shock can cause personal injury. Disconnect electrical power before proceeding. |   |

### Transformer

1. Unplug ice maker or disconnect power.
2. Set the ohmmeter to the appropriate scale.
3. Touch the ohmmeter test leads to the primary black and white leads of the dual transformer. The meter should indicate between 3.5 and 4.5 ohms.
4. Touch the ohmmeter test leads to the secondary yellow and yellow leads of the dual transformer. The meter should indicate between 0.11 and 0.14 ohms.
5. Touch the ohmmeter test leads to the secondary red and red leads of the dual transformer. The meter should indicate between 0.14 and 0.18 ohms.

### Thermistor

| Sensor Temperature °F | Resistance Range $\Omega$ |
|-----------------------|---------------------------|
| 32                    | 29,000 to 31,000          |
| 75                    | 9,500 to 10,500           |

1. Unplug ice maker or disconnect power.
2. Set the ohmmeter to the appropriate scale.
3. For the most accurate measurement, immerse the thermistor in ice water for 5 minutes, then use the 32°F reading in the chart.
4. Touch the ohmmeter test leads to the two evaporator thermistor connectors. The meter should indicate as shown in the chart.

### Cutter Grid

1. Unplug ice maker or disconnect power.
2. Set the ohmmeter to the appropriate scale.
3. Touch the ohmmeter test leads to the pins of the cutter grid 2-wire connector. The meter should indicate 4 to 5 ohms

### Water Pump

1. Unplug ice maker or disconnect power.
2. Set the ohmmeter to the appropriate scale.
3. Touch the ohmmeter test leads to the outside water pump wire connector pins. The meter should indicate approximately 3.6 ohms.

### Reservoir Drain Pump

1. Unplug ice maker or disconnect power.
2. Set the ohmmeter to the appropriate scale.
3. Touch the ohmmeter test leads to the outside reservoir drain pump wire connector pins. The meter should indicate approximately 3.6 ohms.

## Component Testing

### Water Level Sensor

1. Run the diagnostic tests and check for the proper operation of the water level sensor in step 4b.
2. With the water level sensor immersed in water the Service LED should stay on solid.
3. With the water level sensor out of the water the Service LED should blink.

d) Turn the relay over so that the coil faces up, as shown below.

e) With the tip of the ohmmeter test leads at the Start (S) and Run (M) pin sockets, the meter should indicate a closed circuit (0 ohms).

### Measured Water Fill Valve



1. Unplug ice maker or disconnect power.
2. Unsnap and remove the cover from the measured fill water valve.
3. Set the ohmmeter to the appropriate scale.
4. Touch the ohmmeter test leads to the measured fill water valve solenoid terminals. The meter should indicate between 240 and 280 ohms.

### Compressor Start Relay

Position the relay with the coil facing down, as shown below.

- a) Insert the tip on one of the ohmmeter test leads into the Run (M) pin socket, and touch the other ohmmeter lead to the spade terminal. The meter should indicate a closed circuit (0 ohms).
- b) Move the tip of the ohmmeter test lead from the spade terminal into the Start (S) pin socket. Leave the other ohmmeter lead at the Run (M) location. The meter should indicate an open circuit (infinite).

Flow Chart - Overall Operation

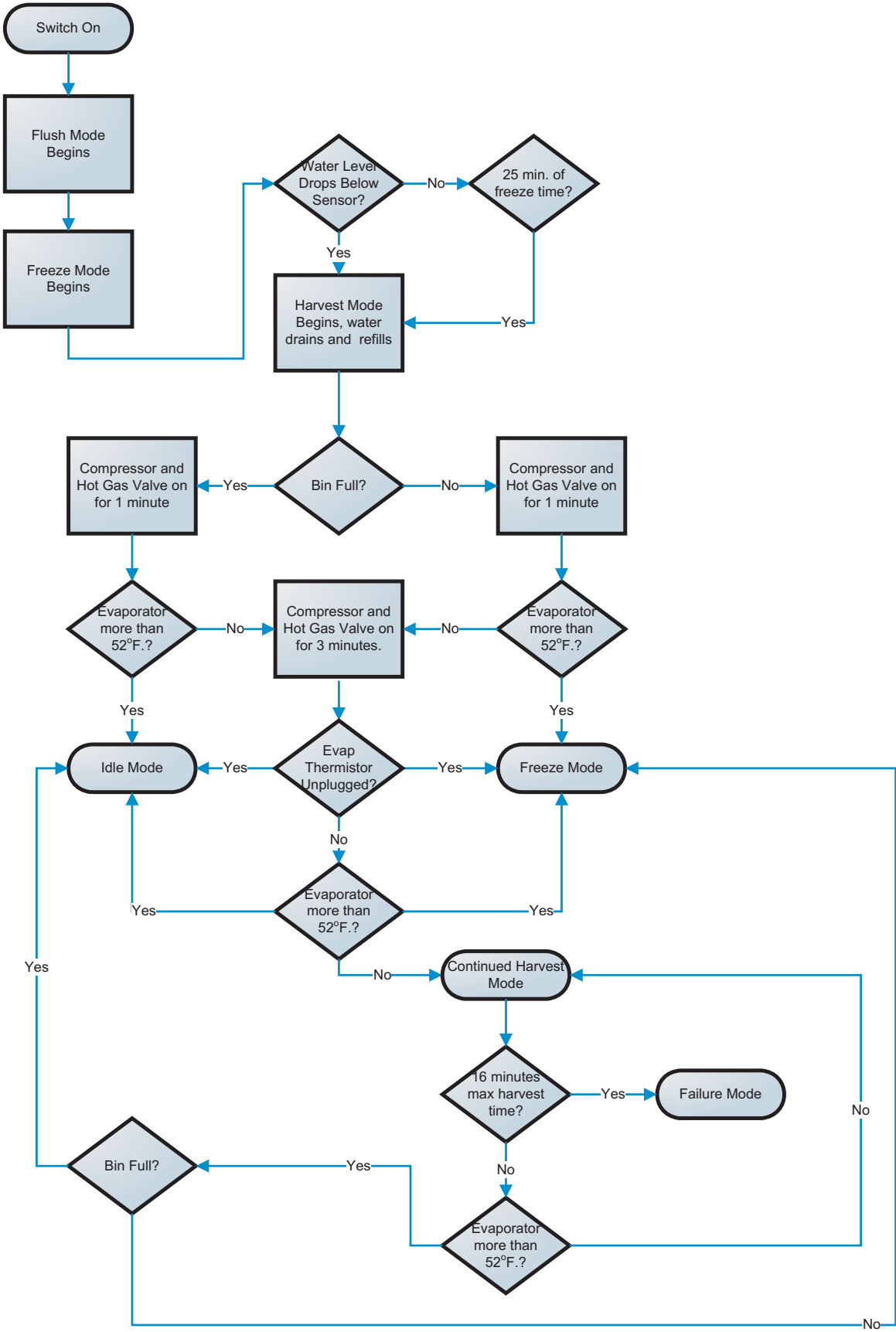

Flow Chart - Freeze Mode Details

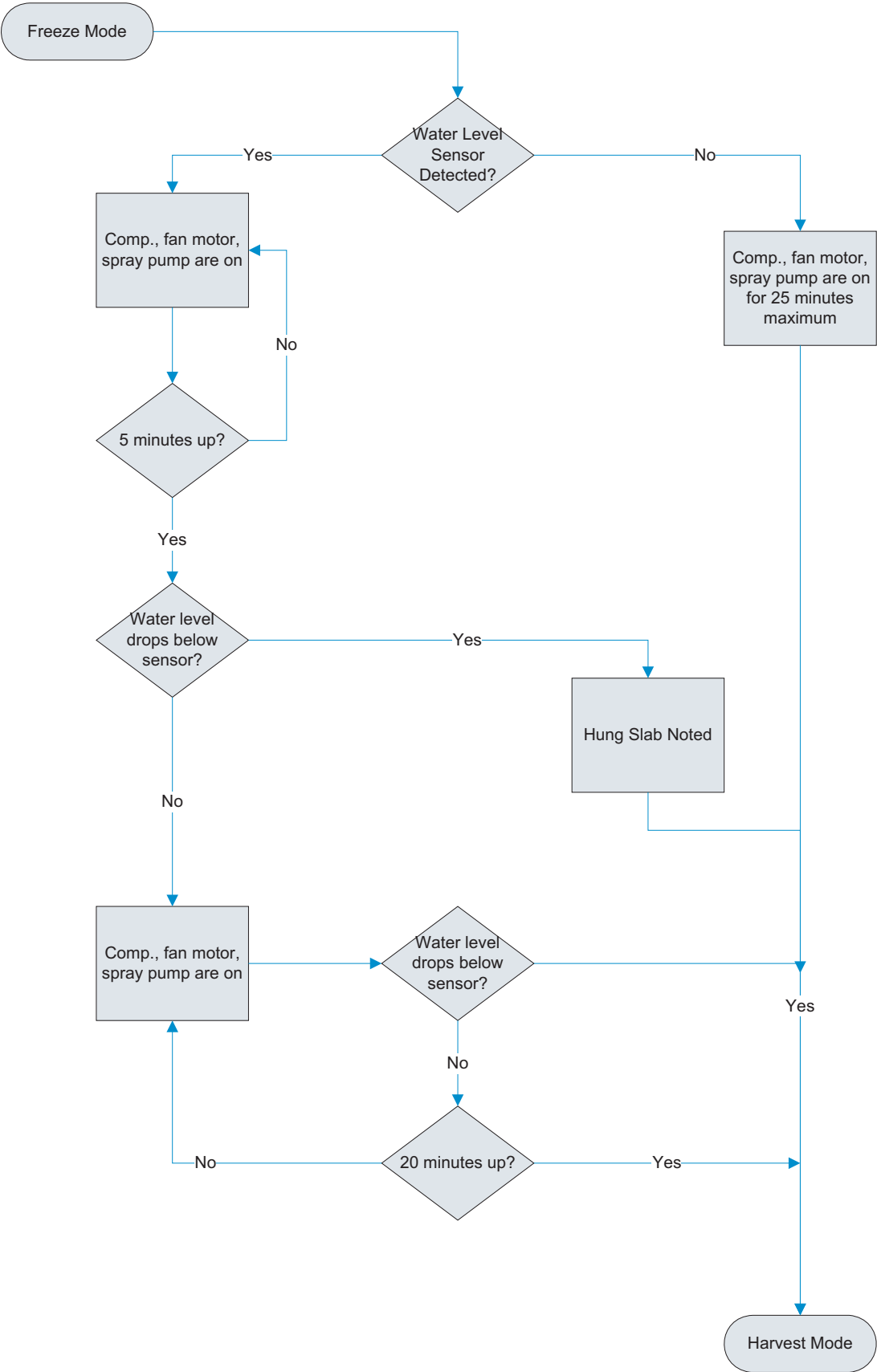



Service Diagnosis

| Symptom  | Possible Cause  | Probable Correction   |
|--|---|---|
| No ice, not operating  | No power at wall outlet   | Check circuit breaker/fuses   |
|  | No power at auxiliary drain pump power outlet   | Check for kinked drain hose, blocked screen or blocked vent outlet or hose. |
|  | Disconnected selector switch  | Reconnect and check for proper operation.                                   |
|  | Room temperature below 55°F. (13°C)   | Bin thermistor has unit shut off  |
|  | Ice touching bin thermistor   | Normal operation  |
| No ice. Will not make ice. Water reservoir is empty. Evaporator is cold with thin or no ice slab.  | Water supply turned off   | Turn on water supply  |
|  | Loose or missing reservoir cap  | Tighten or replace  |
|  | Water slide return tube out of reservoir  | Reposition tube   |
|  | Inlet tube out of position and missing reservoir  | Reposition tube   |
|  | Water inlet tube frozen near evaporator   | Thaw and reposition tube  |
|  | Defective inlet water valve   | Test and repair or replace  |
|  | An ice slab only partially released from evaporator and water was bridged down into the bin | Look for interference with cutter grid and clean the evaporator plate       |
| Will not make ice. Water reservoir is empty. Evaporator is cold with 3/4" thick or larger ice slab | Slab will not release during harvest due to scale build up                                  | Clean the evaporator plate  |
|  | Defective or disconnected hot gas valve   | Test and repair or replace  |
|  | Room temperature over 100°F (38°C)  | Move machine or reduce heat   |
| Off LED on.  | Open or disconnected bin or evaporator thermistor or thermistor wiring                      | Test thermistor & wiring harness or reconnect                               |

Service Diagnosis

| Symptom   | Possible Cause  | Probable Correction   |
|---|---|---|
| Will not make ice. Water reservoir is full. Evaporator is cold with thin/partial/irregular or no ice slab | Seeping water valve. Condenser is hot                                       | Replace water valve   |
|   | Partial refrigerant leak or restriction (U-shaped slab)                     | Check for leak/restriction and repair or replace defective component  |
|   | Defective recirculating pump  | Repair or replace the pump motor assembly   |
|   | Partially blocked water distributor   | Clean distributor and evaporator  |
| Will not make ice. Water reservoir is full. Evaporator is warm.   | Compressor is not running   | Test compressor, relay and overload   |
|   | Blocked condenser or stalled fan motor                                      | Clean condenser, repair or replace motor  |
|   | Unit is in the startup mode   | Wait 5 minutes and recheck  |
| Low capacity  | Room temperature below 55°F (13°C)  | Bin thermistor has unit shut off. Advise user.  |
|   | Seeping water valve. Condenser is hot                                       | Replace water valve   |
|   | Slow or defective drain or drain pump causing water to back up into the bin | Repair or replace drain or drain pump   |
|   | Airflow blocked   | Remove blockage   |
|   | Control in extended cycle mode  | Go to manual test 9, if clean light is blinking, push Clean button once.  |
| Too much ice in bin   | Defective bin thermistor  | Test and replace thermistor   |
| Noise   | Banging sound   | The slab dropping off the plate and ice dropping from the cutter grid into an empty bin are normal sounds                     |
|   | Grinding, cavitating sound.   | The reservoir is empty. Look for a partially released slab, interference with cutter grid etc and clean the evaporator plate. |
|   | Grinding, cavitating sound from recirculating pump                          | If the reservoir is full replace the pump   |
|   | Noisy drain pump  | Repair or replace   |
| Ice freezing together in the bin  | Normal if little ice is used.   | Use more ice.   |

## Removal and Replacement - Thermistor

|  |   |
|--|---|
| <p><b>⚠ WARNING</b></p>  |  |
| <p><b>Electrical Shock Hazard</b><br/>Electrical shock can cause personal injury. Disconnect electrical power before proceeding.</p> |   |

Slide the cutter grid forward and out of the unit and place it on a work surface.

Be careful not to scratch the ice maker liner.

d) Remove the spacer from the right cutter grid bracket tab.

Unsnap the two ice guides from the cutter grid tabs. There should be a slight outward tilt after the guides are installed. Bend the metal tabs outward if necessary.

### Bin Thermistor and / Or Cutter Grid

1. Unplug ice maker or disconnect power.
2. Open the ice maker door.
3. Cover or remove the ice from the storage bin.
4. Place a cloth in the drain hole to avoid hardware from falling inside.
5. Remove the two hex-head screws from the cutter grid cover and remove the cover.

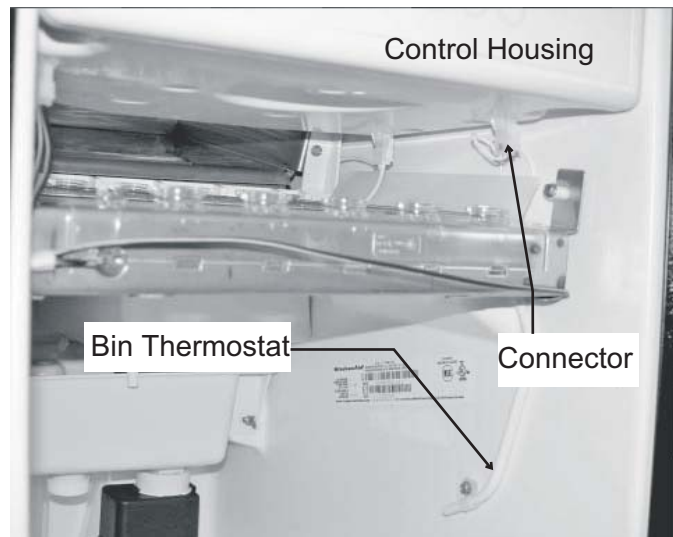
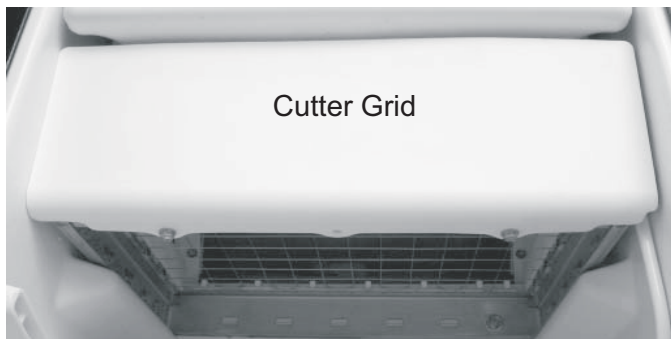

6. To remove the bin thermistor:

- a) Disconnect the bin thermistor connector from the bottom of the control housing.
- b) Pull the bin thermistor out of the retaining clamp and remove it.

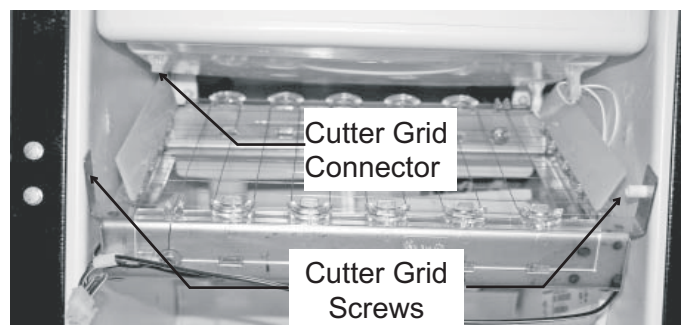

7. To remove the cutter grid:

- a) Disconnect the cutter grid and bin thermistor connectors from the bottom of the control housing.
- b) Remove the two hex-head screws from both sides of the cutter grid. The longer screw and white spacer are on the right side.

## Removal and Replacement

To remove the evaporator thermistor:

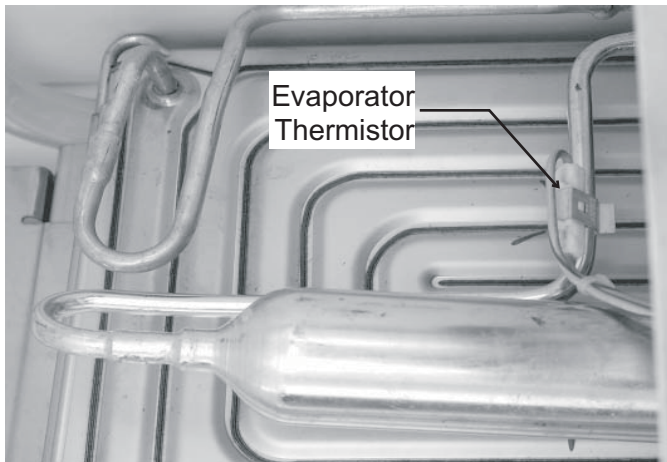

- Remove the cutter grid from the unit
- Disconnect the evaporator thermistor connector from the bottom of the control housing.
- Remove the two hex-head mounting screws from the water trough and pull the trough from the unit.

Reach behind the accumulator, and unclip the evaporator thermistor from the evaporator tubing and remove it.

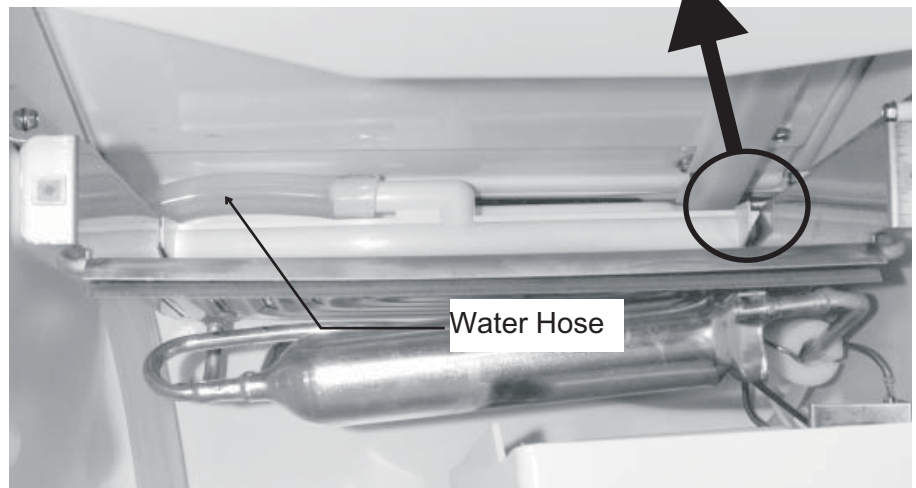

To remove the water distributor:

- Remove the cutter grid from the unit
- Pull out on the left and right water distributor retainers, and remove the tabs from the slots in the evaporator. Pull the distributor forward and remove the water hose.



Water Distributor

## Removal and Replacement - Controller

|  |   |
|--|---|
|  <b>WARNING</b>                             |  |
| <b>Electrical Shock Hazard</b><br>Electrical shock can cause personal injury. Disconnect electrical power before proceeding. |   |

1. Unplug ice maker or disconnect power.
2. Open the ice maker door.
3. Cover or remove the ice from the storage bin.
4. Remove the cutter grid cover and the cutter grid.
5. Disconnect the remaining two connectors (bin and evaporator thermistors) from the bottom of the control housing.

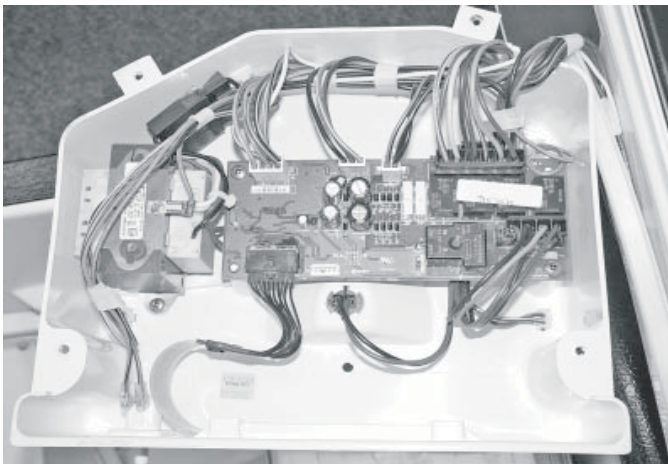

6. Remove the four hex-head screws from the control housing and lower the housing so that you can access the components.

NOTE: The control housing components consist of:

- (1) Electronic control board
- (2) Dual transformer
- (3) Light switch
- (4) Push-button switch assembly

7. To remove the electronic control board:
  - a) Disconnect the six harness connectors from the board terminals.
  - b) Remove the two mounting screws.

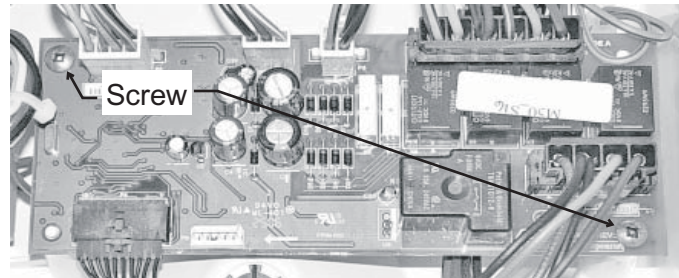

### Water Pump

- Unplug ice maker or disconnect power.
2. Open the ice maker door.
3. Remove the ice from the storage bin.
4. Unscrew the drain cap from the reservoir, drain the water, and replace the cap tightly.
5. Place a cloth in the drain hole to avoid hardware from falling inside.
6. Remove the hex-head screw from the water recirculation pump shield and remove the shield (see the photo below).

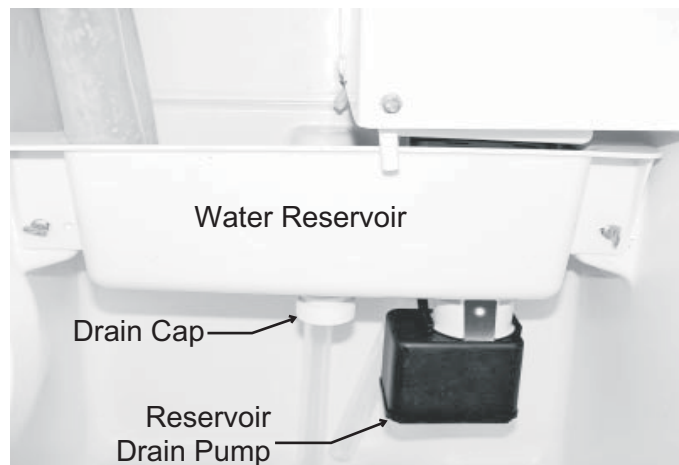



## Removal and Replacement

|  |   |
|--|---|
| <b>⚠ WARNING</b>   |  |
| <b>Electrical Shock Hazard</b><br>Electrical shock can cause personal injury. Disconnect electrical power before proceeding. |   |

7. Disconnect the water fill tube from the pump mounting bracket.

8. Disconnect the two wire pump connectors from the harness block.

9. Remove the two thumbscrews from the reservoir and remove the reservoir from the ice maker.

10. Remove the pump outlet tube.

11. Remove three hex-headed screws from the pump mounting bracket and remove pump assembly.

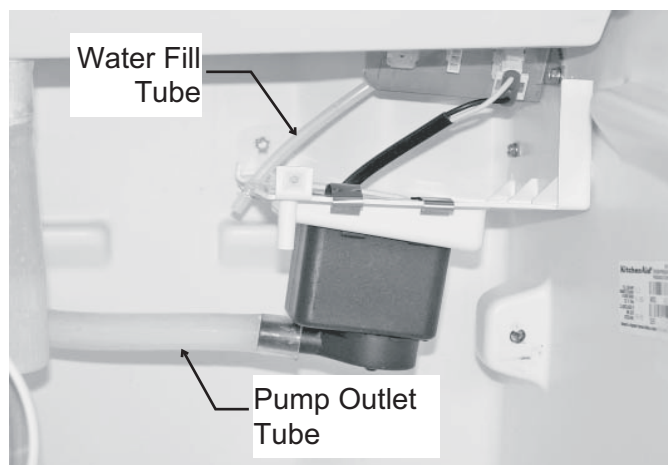

12. Separate the recirculation pump from the bracket.

### Reservoir Drain Pump and /or Water Level Sensor

1. Unplug ice maker or disconnect power.

2. Open the ice maker door.

3. Unscrew the drain cap from the reservoir, drain the water, and replace the cap tightly.

4. Remove the recirculating pump cover hexhead screw.

5. To remove reservoir drain pump:

a) Disconnect the reservoir drain pump electrical connection.

b) Remove the pump retaining screw and bracket.

c) Rotate the pump 1/4 turn and pull it down and out of reservoir.

6. To remove the water level sensor:

a) Disconnect the water level sensor electrical connection.



b) Remove the retaining clips, if present.

c) Pull the sensor up and out of the bracket.

## Removal and Replacement - Evaporator

|  |   |
|--|---|
| <p><b>⚠ WARNING</b></p>  |  |
| <p><b>Electrical Shock Hazard</b><br/>Electrical shock can cause personal injury. Disconnect electrical power before proceeding.</p> |   |

### Evaporator

1. Unplug ice maker or disconnect power.
2. Open the ice maker door.
3. Remove the ice from the storage bin.
4. Remove the cutter grid and the evaporator thermistor from the unit.
5. Disconnect the bin thermistor connector from the bottom of the control housing.
6. Remove the top door screw from the ice maker door, and pull the door off the bottom hinge.
7. Remove the two 5/16" hex-head screws from the top hinge and remove the hinge.
8. Remove the two front and two rear screws from the cabinet top.

Lift the cabinet top and position it forward on top of the unit.

From the rear of the unit, remove the six hex-head screws from the channel cover and remove the cover.

12. Remove the four screws from the unit compartment cover and remove the cover.

13. Cut the tie wrap from around the tubing and wire harness inside the channel.



14. Remove the two screws from the reservoir water trough and remove the trough.

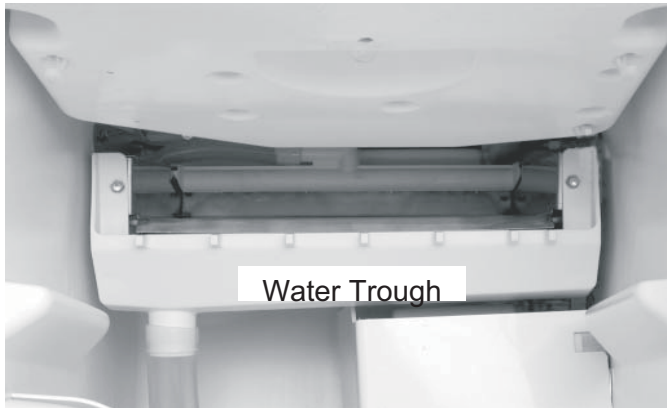

Remove the hex-head screw from the water pump shield and remove the shield.



16. Remove the water fill tube from the notch in the water pump bracket, and pull the free end of the water line up, out of the unit.



17. Pull out on the left and right water distributor retainers and remove the tabs from the slots in the evaporator, disconnect it from the hose, and remove it.

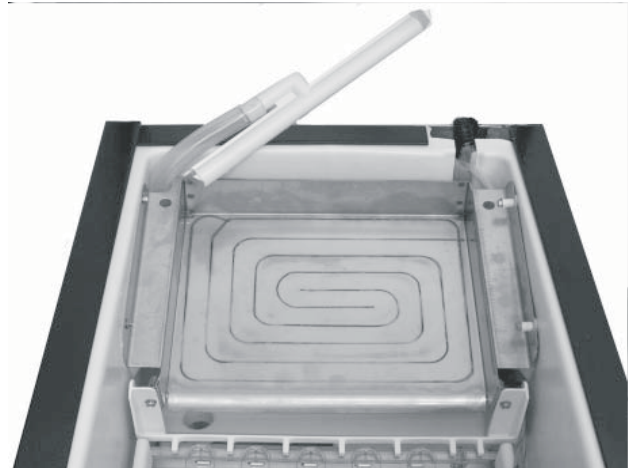

18. Remove the four screws from the evaporator, then carefully lift the evaporator just high enough to remove the two right spacers.

Remove the Permagum from the liner channel.

20. Lift the cabinet top off the unit and stand it on the floor near the rear of the unit.

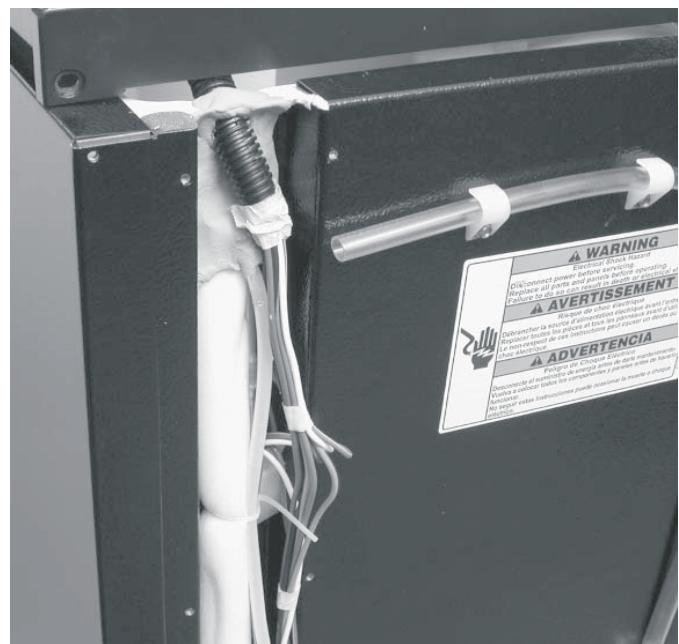



21. Lift the evaporator and its connecting tubing high enough from the unit to access the tubing underneath.

Access the sealed system and discharge the refrigerant into an approved recovery system.

**IMPORTANT:** Refrigerant lines must be connected by a licensed, EPA certified refrigerant technician in accordance with established procedures.

#### REASSEMBLY NOTES:

When installing the new evaporator, use a generous amount of thermal heat trap paste between the hot gas valve, and the evaporator tubing joint to protect the hot gas valve when brazing.



23. Unbrazed (and cut) the evaporator from the tubing at the following locations:

- Suction line at the compressor.
- Hot gas line at the hot gas valve.
- Cut capillary tube at the drier fit

- Be sure to reinstall the Permagum in the liner channel of the cabinet around the wire sheath and tubing, so that there are no air leaks after the cabinet top is installed





---

SCOTSMAN ICE SYSTEMS

775 Corporate Woods Parkway, Vernon Hills, IL 60061

800-533-6006

[www.scotsman-ice.com](http://www.scotsman-ice.com)

17-3187-01

Enodis®