

LIEBHERR

Design Guide 2008
Built In Models 30" and 60"

Liebherr's engineering excellence in Germany provides the largest selection of freezers, refrigerators and wine refrigerators worldwide.

Liebherr-Hausgeräte consistently specializes in the manufacturing of high quality freezers and refrigerators. With more than 300 basic models, we have the widest selection in the world. Liebherr appliances feature premium quality, numerous innovative product ideas and advanced design. Liebherr freezers and refrigerators are manufactured at three modern production plants:

Liebherr Marica in Bulgaria, Liebherr-Hausgeräte Ochsenhausen GmbH in Germany and the Liebherr-Hausgeräte Lienz GmbH in Austria.

We produce more than 2.3 million quality freezers, refrigerators and wine refrigerators each year, and these are sold all over the world. Liebherr-Hausgeräte Ochsenhausen GmbH in Germany makes over 1,100,000 appliances a year and employs 1,900 people. The Liebherr-Hausgeräte Lienz GmbH manufactures more than 700,000 freezers and refrigerators and employs 1,500 people.

The appliances for the North American market are produced in Austria and in Germany.

Liebherr is committed to the protection of the environment and recognizes it as a critical priority. To guarantee an optimum and consistent implementation, all ecological aspects were observed and integrated into the quality control of Liebherr in compliance with DIN EN ISO 9001.

Liebherr's Commitment to the Environment

The components of Liebherr products can be recycled when the necessary resources are applied. A concern for the environment and a desire to protect resources has led to increased levels of recycling year after year. When Liebherr manufactures products, it is essential that the recyclable recovery rate of the materials we use constantly increases.

Recycling is a common goal among all manufacturers, municipalities and recycling companies to protect our environment. Protecting the environment and producing products which have a low impact on the environment, is one of Liebherr's core values. Whether you are replacing a unit or starting fresh, remember to dispose of your old appliance in an environmentally safe and friendly manner.

Introduction

LIEBHERR WARRANTY PLAN

FULL TWO YEAR WARRANTY - For two years from the date of original purchase, your Liebherr Warranty covers all parts and labor to repair or replace any part of the product which proves to be defective in materials or workmanship.

FULL FIVE YEAR WARRANTY - For five years from the date of original purchase, your Liebherr Warranty covers all parts and labor to repair or replace any components that prove to be defective in materials or workmanship in the sealed system. The "Sealed System" means only the compressor, condenser, evaporator, drier and all connecting tubing.

LIMITED 6TH THROUGH 12TH YEAR WARRANTY - From the 6th through 12th year from the date of original purchase, your Liebherr Warranty covers all parts that prove to be defective in materials or workmanship in the sealed system (parts only).



Customer Service

If your appliance is not working properly, or if the temperature display reads "F0" to "F5", please call the numbers listed below.

Give the **fault number displayed**, together with the **Type Designation, Service Number** and **Appliance Number (Serial Number)** from the model plate, to ensure prompt, accurate servicing. The model plate is located inside the appliance.

Leave the appliance door closed until the customer service technician arrives to minimize any further cold loss.

For Service and Parts in the U.S.:

Liebherr Service Center

15545 N. 77th Street
Scottsdale, AZ 85260

Phone: (480) 998-0141
Fax: (480) 998-7877
Toll Free: **1-866-LIEBHERR or
1-866-543-2437**

www.liebherr-appliances.com

For Service and Parts in Canada:

Euro-Line Appliances

2278 Speers Rd.
Oakville, Ontario, L6L 2X8

Phone: (905) 829-3980
Fax: (905) 829-3985
Toll Free: **1-888-Liebherr,
1-888-543-2437**

www.euro-parts.ca

Contents

General Remarks

| | |
|---|------------|
| Safety Warnings | I |
| Electrical Requirements & Safety | II |
| IceMaker (if equipped) | III |
| Area Requirements | IV |
| Safety Regulations | V |

Built In Models 30" and 60"

| | |
|--|-----------|
| CI16.., C16.., SBS3210, SBS320 | 1 |
| Unit Dimensions | 2 |
| Cabinet Opening Dimensions | 4 |
| Ventilation Requirements | 5 |
| | |
| Custom finish CI 1601, CI 1650, CI 1651, SBS 3210 - Framed and Overlay Panels | 7 |
| Framed Panel Dimensions | 8 |
| Handle Clearance | 9 |
| Overlay Panel Dimensions | 10 |
| Accessories for Framed and Overlay Panels | 11 |
| Door Swing Clearance 130° CI Models | 13 |
| Door Swing Clearance 90° CI Models | 14 |
| | |
| Stainless steel C 1601, C 1650, C 1651, SBS 320 | 15 |
| Accessories | 16 |
| Door Swing Clearance 130° C Models | 17 |
| Door Swing Clearance 90° C Models | 18 |

General Remarks

I. Safety Warnings

PLEASE READ AND FOLLOW THESE INSTRUCTIONS

This design guide contains Warning and Caution statements. This information is important for safe and efficient installation.

This design guide is not replacing the user care manual which contains important information on how to use Liebherr appliances.

Always read and follow all Warning and Caution statements!

██████████  **WARNING** ██████████

States a hazard that may cause serious injury or death if precautions are not followed.

██████████  **CAUTION** ██████████

Signals a situation where minor injury or product damage may occur if you do not follow instructions.

██████████  **DANGER** ██████████

States a hazard will cause serious injury or death if precautions are not followed.

IMPORTANT

This highlights information that is especially relevant to a problem-free installation.

Make sure incoming voltage is the same as the unit rating.

To reduce the risk of fire, electric shock, or personal injury, the installation work and electrical wiring must be done by a qualified electrician in accordance with all applicable codes and standards, including fire rated construction.

To the Installer

It is very important that the guidelines and instructions are followed in this design guide to ensure proper installation and operation of the unit. The Installation Guidelines section contains important information for making sure the installation is correct. Read and understand all the information and installation guidelines in this manual before the unit is installed.

It is also very important to **know** the Safety Information.

General Remarks

II. Electrical Requirements & Safety

A 115 Volt, 60 Hz, 15 Amp (20 Amp for side-by-side installation) fused electrical supply is required. Connect undercounter wine cabinet to a 115 VAC, 10 amp (15 Amp for side-by-side installations) circuit that is controlled by a circuit breaker or fuse.

We recommend using a dedicated circuit for these appliances to prevent electrical overload. Comply with the National Electrical Code as well as local codes and ordinances when installing the receptacle.

The power cord is equipped with a three-prong (grounding) plug for your protection against possible shock hazards. To maintain this protection:

- Do not modify the plug by removing the round grounding prong.
- Do not use a power cord that is frayed or damaged.



WARNING

Do not ground to a gas pipe. Check with a qualified electrician if you are not sure the appliance is properly grounded. Do not have a fuse in the neutral or grounding circuit.



WARNING

ELECTROCUTION HAZARD

Electrical Grounding Required. This appliance is equipped with a three-prong(grounding) polarized plug for your protection against possible shock hazards.

- **DO NOT** remove the round grounding prong from the plug.
- **DO NOT** use a two-prong grounding adapter.
- **DO NOT** use an extension cord to connect power to the unit.

III. IceMaker (if equipped)

The icemaker is located in the freezer compartment. It must be connected to the water supply to function properly. The appliance must be level for the icemaker to function properly.

The water pressure must be between 21.8-87.0 psi (1.5-6 bar). Use a 1/4" OD copper line to connect the water supply to the solenoid valve. This is not supplied with the refrigerator.

If you have hard water, we recommend you install a water softener. Also, a filter must be installed if the water contains solids such as sand. All equipment and devices used to supply the water to the appliance must comply with the current regulations for your geographical area.

Safety Instructions and Warnings

- Do not attach the water source while the appliance is connected to an electrical outlet.
- A shut-off valve, must be installed between the hose line and the main water supply so that the water supply can be stopped if necessary. Do not install the shut-off valve behind the refrigeration unit.
- The connection to the water supply may only be made by a trained and licensed plumber.
- The water quality must comply with the drinking water regulations for the geographical area where the appliance is located.
- The icemaker is designed exclusively to make ice cubes in quantities needed by a household and may only be operated with water appropriate for this purpose.
- All repairs and work on the icemaker may only be done by customer service personnel or other trained personnel.
- The manufacturer cannot accept liability for damage caused by equipment or water lines between the solenoid valve and the water supply.

General Remarks

IV. Area Requirements

Verify the following:

- Floors can support refrigerator's weight plus approximately 1200 pounds (544 kg) of food weight. Not all Liebherr products are designed for 1200 pounds (544 kg) of food. Some units are smaller and total weights may vary.
- Finished kitchen floor height is level. Refrigerator must be shimmed to the floor level, or levelled, to make sure, air vents are not obstructed.
- Remove anything attached to the rear or side walls that can obstruct refrigerator opening.
- Cutout dimensions are accurate.
- Electrical outlet is in correct location.

Do not install this unit next to any other refrigerator or freezer except another Liebherr model. Liebherr models are designed to allow side by side installation. They are equipped with a heating system to eliminate condensation when units are installed side by side. Installing this unit next to any other refrigerator or freezer can cause condensation or cause damage to the Liebherr unit.



CAUTION

To protect the refrigerator from possible damage, allow the appliance to stand 1/2 to 1 hour in place before turning the electricity on. This allows the refrigerant and system lubrication to reach equilibrium.

Blocking For Safety

The anti-tip brackets must be installed to prevent the unit from tipping after it is installed. Refer to Blocking For Safety.

V. Safety Regulations

The appliance complies with UL250 and CAN/CSA-C 22,2 No. 63 and is designed to cool, freeze, store food as well as make ice (if equipped). It is designed as a household appliance. If used commercially, the relevant regulations on commercial use must be observed.

The appliance is set to operate within specific ambient temperature limits according to its climate rating. These temperature limits should not be exceeded. The correct climate rating for your appliance is indicated on the model plate.

This is explained as follows:

| Climate Rating | Set for Ambient Temperatures of |
|----------------|---------------------------------|
| SN | 50°F to 90°F (10°C to 32°C) |
| N | 61°F to 90°F (16°C to 32°C) |
| ST | 65°F to 100°F (18°C to 38°C) |
| T | 65°F to 109°F (18°C to 43°C) |
| SN-ST | 50°F to 100°F (10°C to 38°C) |
| SN-T | 50°F to 109°F (10°C to 43°C) |

- The refrigerant circuit has been tested for leaks.

CI16..., C16..., SBS3210, SBS320

The Liebherr 30" built-in refrigerator-freezers are available with stainless steel doors (C-models) and with custom finished panels on the doors (CI-models). High quality stainless steel trims enhance the harmonious interior of the refrigerator.

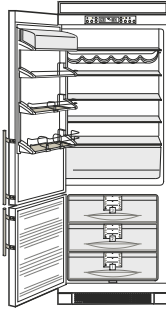

| | |
|---------------------------|--------------------|
| C & CI 1601 | |
| Energy Star: | qualified |
| Energy consumption p. a.: | 460 kWh |
| Energy Supply: | 115V/60Hz/350W |
| Total capacity: | 15.5 cu ft (438 L) |
| Refrigerator: | 11.3 cu ft (320 L) |
| Freezer: | 4.2 cu ft (118 L) |
| Climate Rating: | SN-T |
| Door hinges: | left / reversible* |

- Automatic refrigerator defrosting
- Automatic freezer compartment defrosting

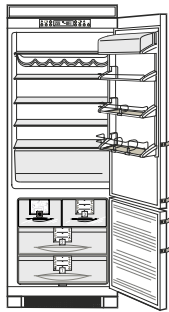

| | |
|------------------------------|---------------------|
| C & CI 1650, 1651 | |
| Energy Star: | qualified |
| Energy consumption p. a.: | 460 kWh |
| Energy Supply: | 115V/60Hz/350W |
| Total capacity: | 15.4 cu ft (436 L) |
| Refrigerator: | 11.3 cu ft (320 L) |
| Freezer: | 4.1 cu ft (116 L) |
| Ice cube capacity: | 2.2 pd./24h |
| Ice cube stock: | 3.3 pd. |
| Climate Rating: | SN-T |
| Door hinges: | right / reversible* |
| Models C & CI 1651: | left / reversible* |

- Automatic refrigerator defrosting
- Automatic freezer compartment defrosting
- Automatic IceMaker can be switched off

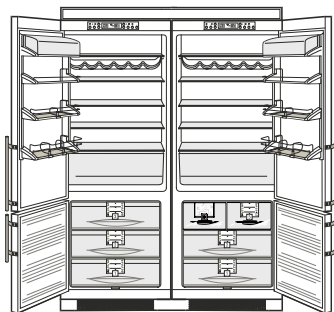

| | |
|--|----------------------------|
| SBS 320 & 3210 (C, CI 1601 & C, CI 1650)* | |
| Energy Supply: | 115V/60Hz/700W |
| Total capacity: | 30.9 cu ft (874 L) |
| Refrigerator: | 22.6 cu ft (640 L) |
| Freezer: | 8.3 cu ft (234 L) |
| Ice cube capacity: | 2.2 pd./24h |
| Ice cube stock: | 3.3 pd. |
| Climate Rating: | SN-T |
| Door hinges: | left / right / reversible* |

- Automatic refrigerator defrosting
- Automatic freezer compartment defrosting
- Automatic IceMaker can be switched off

* optional reverse door kit required

Unit Dimensions

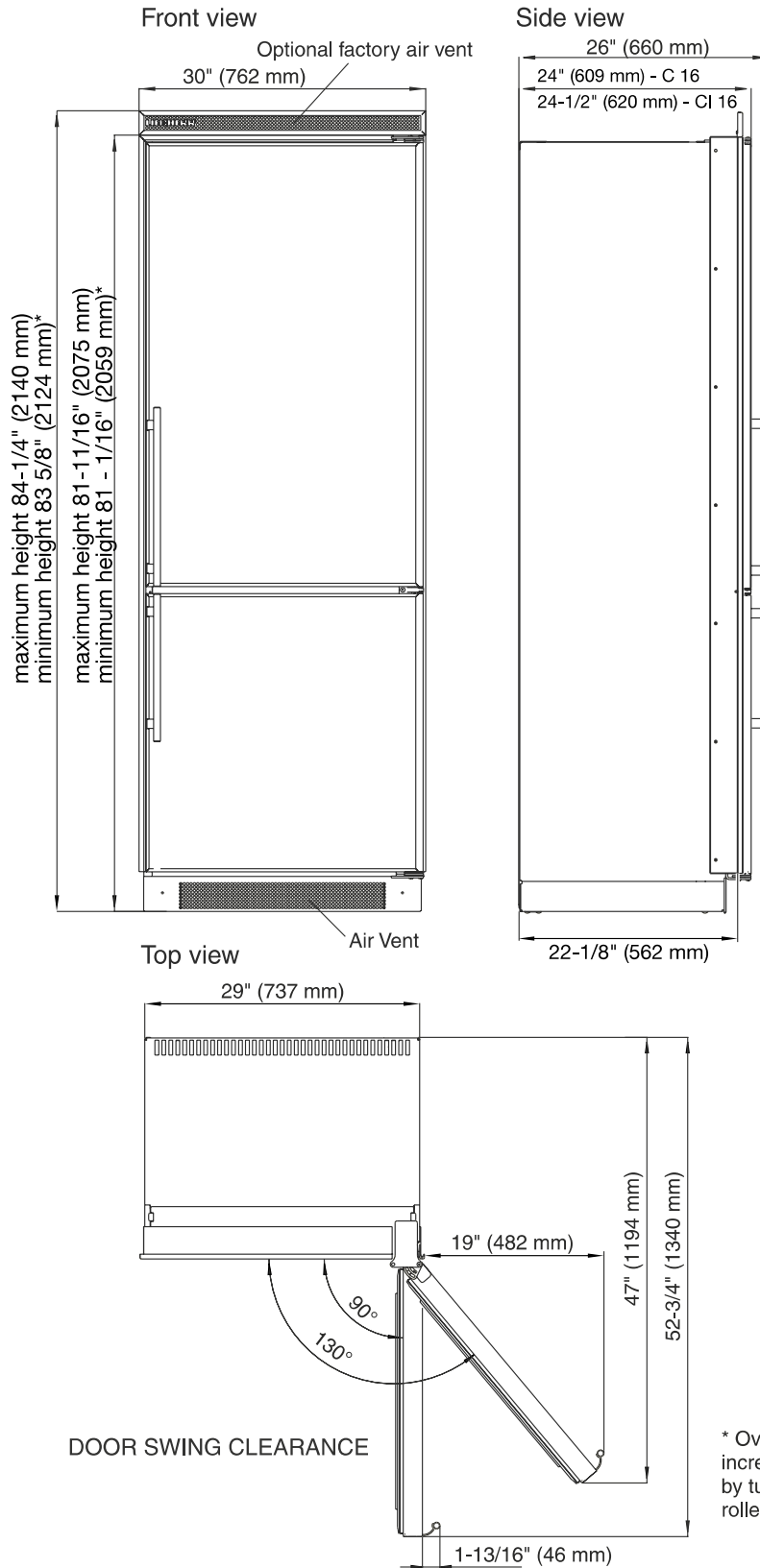

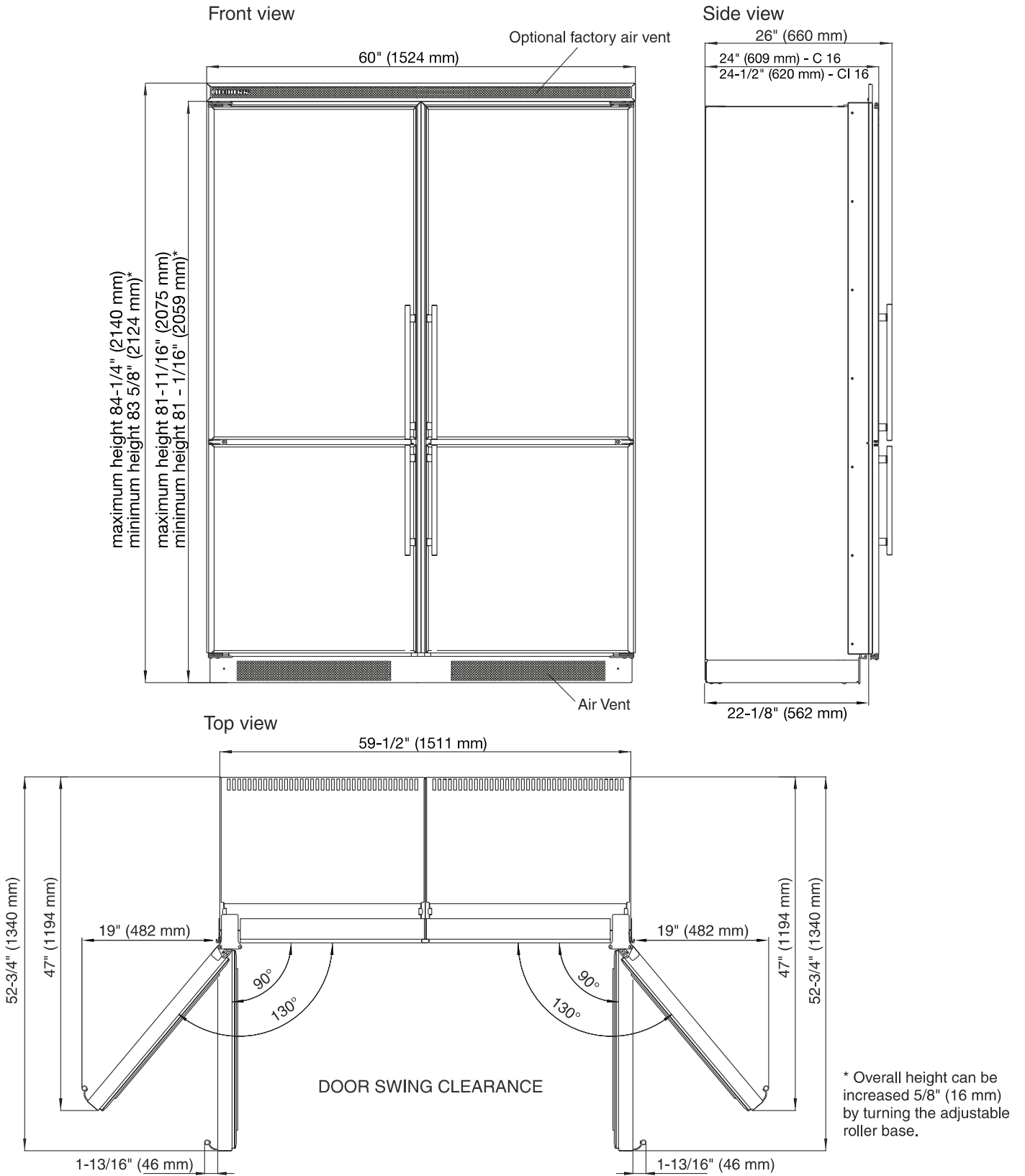

Cabinet Opening Dimensions

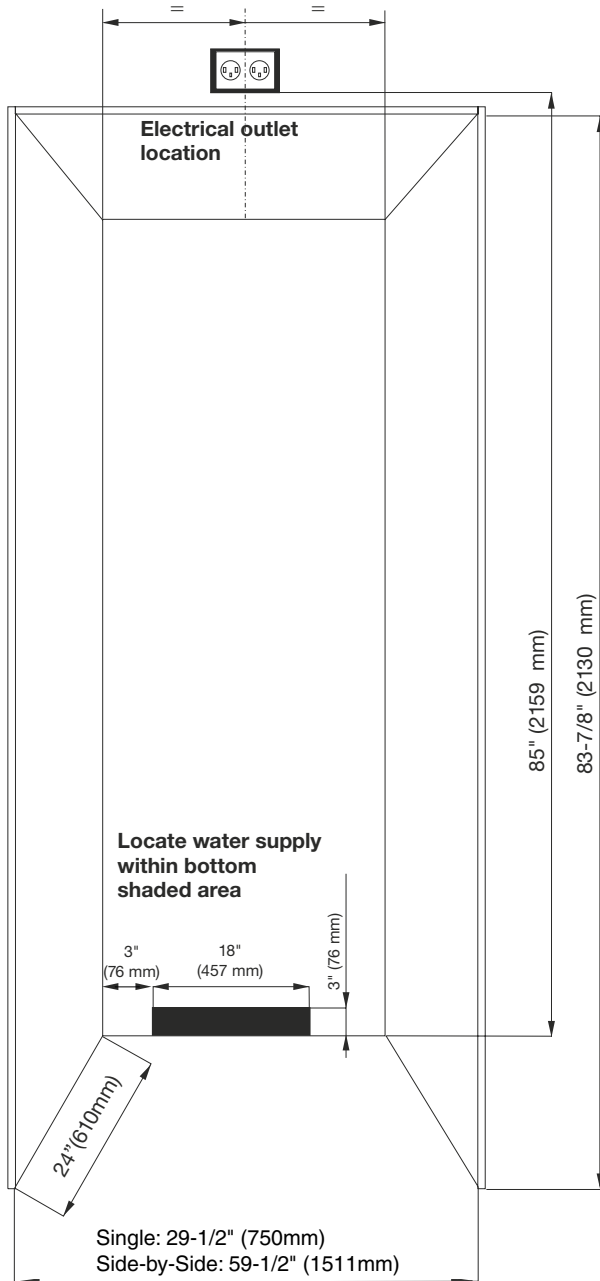

Allow units to open a minimum of 90° to prevent problems removing drawers. With the door opening 90°, you may have to move drawers slightly to clear the door interior.

- Allow for a minimum 2" (51 mm) filler, for corner installations, so the door can open to 90°. If you're using raised panels, consider using a wider filler.

IMPORTANT

Refer to the minimum door clearances and illustrations at the end of this section for specifics on door openings and filler size alternatives.

NOTE:

The given cabinet opening height dimension includes 2" for top air vent. If you choose to place the vent above the cabinet or in a soffit, you will need to adjust the height dimension accordingly.

Ventilation Requirements

This type of cabinet must be carefully constructed using the correct dimensions and it must provide suitable ventilation to ensure proper appliance operation.

Kitchen Cabinet Airflow

1. The following ventilation dimensions must be observed:

There must be a ventilation space at least 31 in.² (200 cm²) at the airflow inlet (1) and at the airflow outlet (2). The 30" and 60" models are equipped with a rolling base, which is already providing you with the bottom airflow inlet requirements.

The top ventilation space can be directed in one of the following ways:

- A) Directly over the appliance (2) with either an optional factory air vent or custom made one using the template supplied with the unit.
- B) Above the cabinet and below the ceiling (3).
- C) Through a vent installed in a soffit (4).

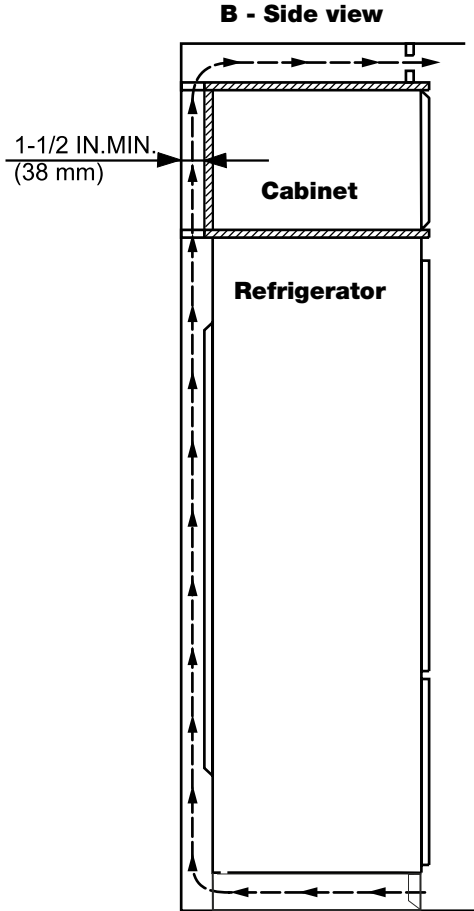
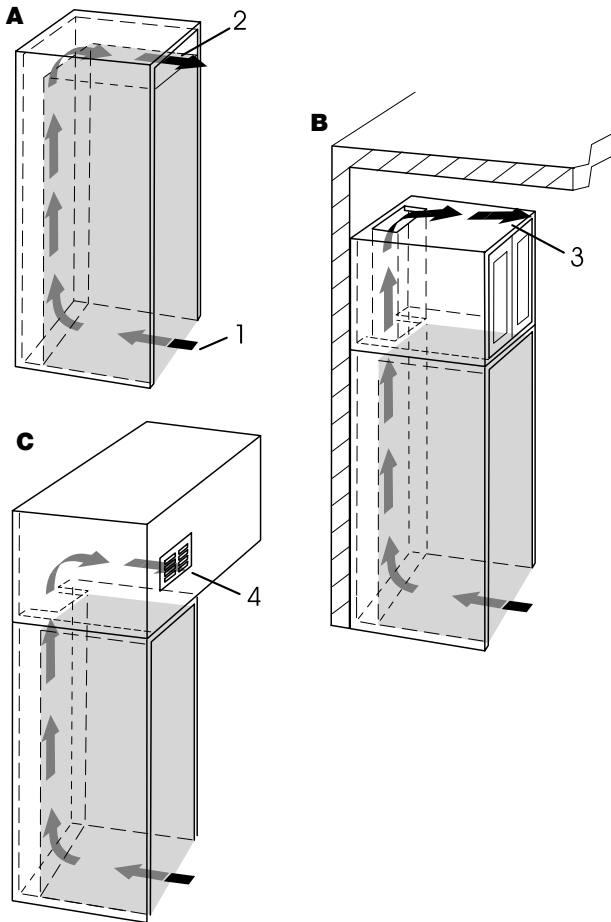

The refrigerator is designed to allow proper air flow when the appliance is installed up against the wall. A minimum space of 1 1/2" is required when a cabinet is built above.

Built In Models 30" and 60"

**Custom finish CI 1601, CI 1650, CI 1651, SBS 3210 -
Framed and Overlay Panels**

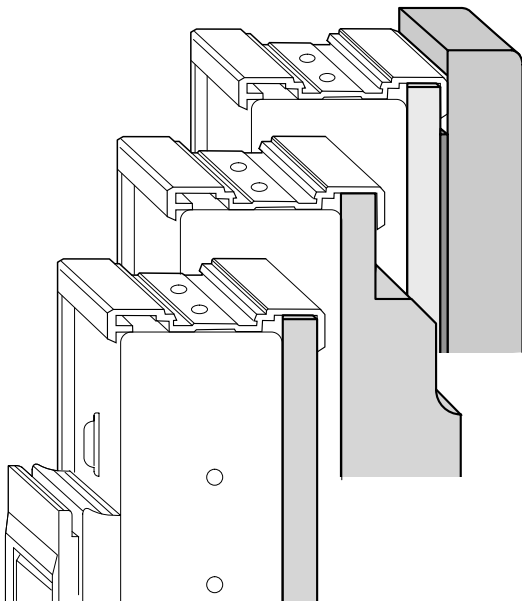

Liebherr offers numerous options for customization, allowing you to best complement the design of your dream kitchen. Decor frames make it possible to put custom panels on the built-in appliances. To match your kitchen's design, use custom finish panels, overlay or framed.

Framed Panel Dimensions

Integrating Cabinetry

Framed Panels

If the thickness of the custom panels is less than 1/4" (6.4 mm), they must be backed up with a sheet of shim material to build the total thickness to 1/4" (6.4 mm).

If the panel is thicker than 1/4" (6.4 mm), an edge must be routed around the panel to ensure a proper fit.

The door handles must be installed before the screw covers are installed. If you fail to install the handles before the screw covers, you can damage the covers. The screw covers are taped to the unit doors during shipping. Use care when removing covers.

The door panel weight must not exceed 25 lb. (11.3 kg) per panel.

Panels 1/4" (6.4 mm) thick or less

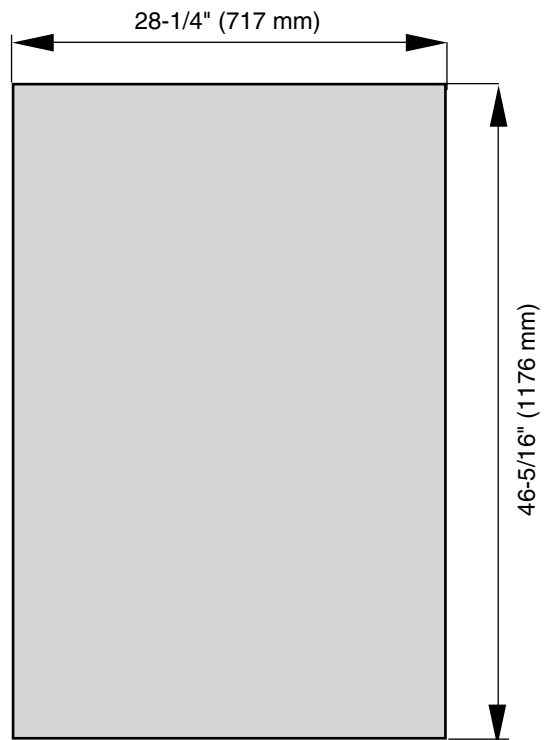
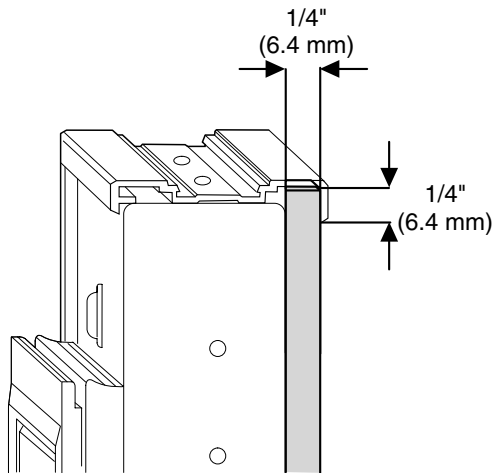

Panels thicker than 1/4" (6.4 mm)

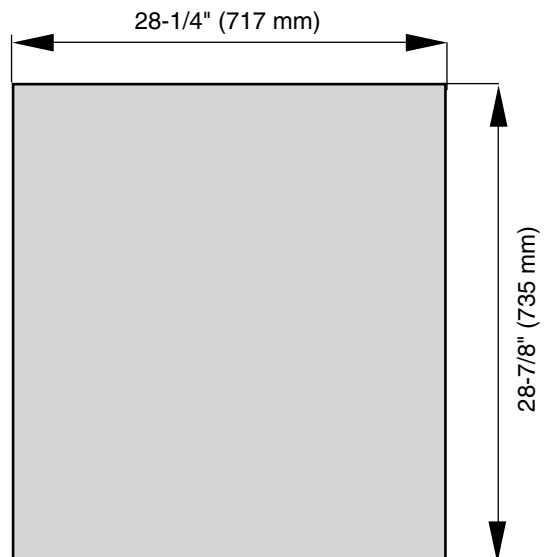
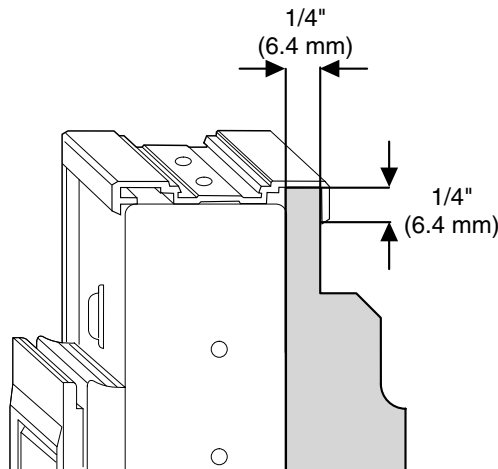

Handle Clearance

It is important to provide adequate clearance behind the handle so that the user's hand fits easily. The clearance may not have to be the entire length of the handle, but should be designed for user's comfort.

Please note that for framed installations, the optional factory Liebherr handles must be ordered.

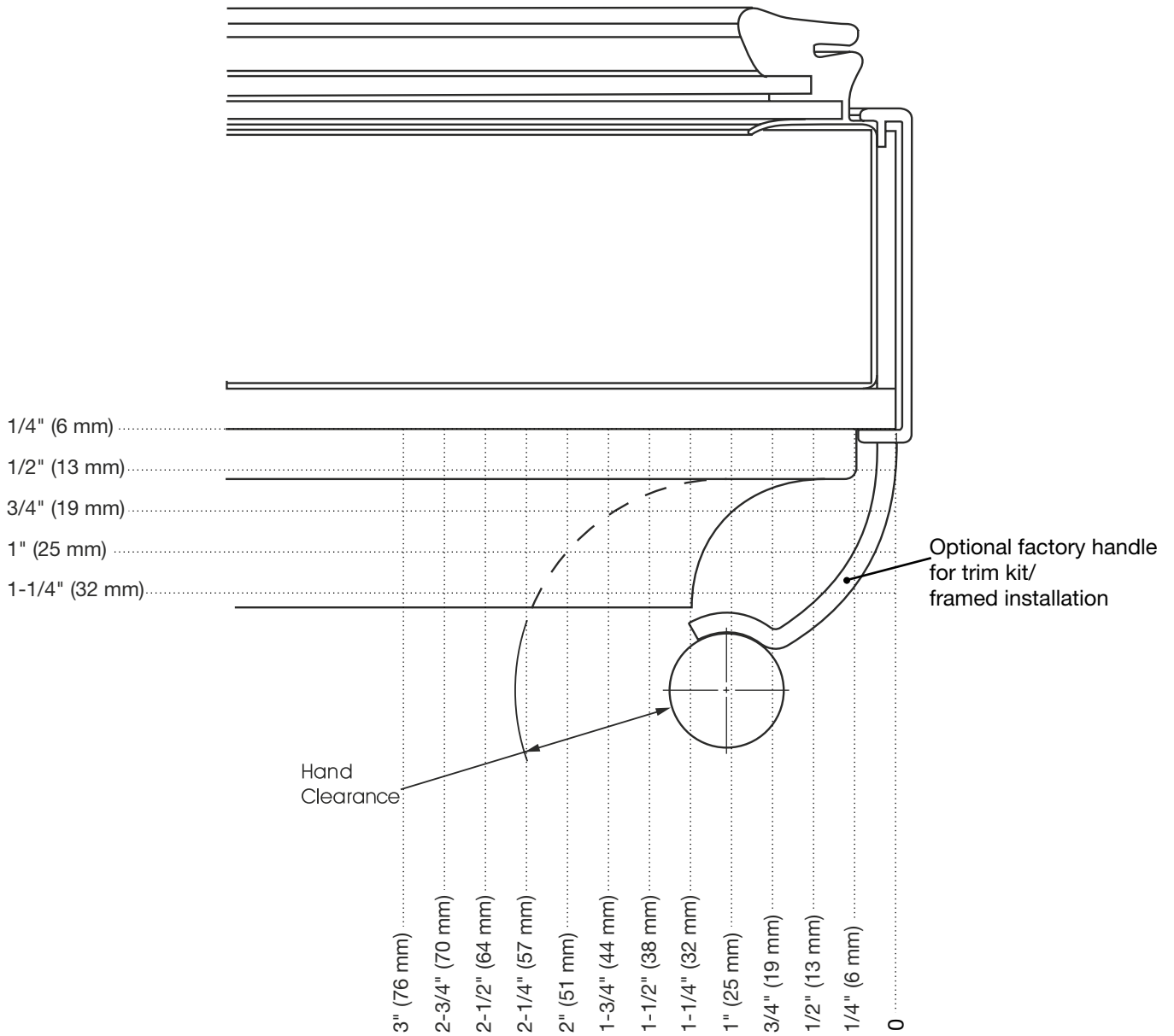

Scale 1:1

Overlay Panel Dimensions

Overlay Panels

The overlay design allows decorative panels to cover the door trim for a more seamless appearance that blends with the design of the room. The most common way to achieve this look is to work with three panels, the decorative overlay panel, a 3/32" (2.5 mm) spacer panel and a 1/4" (6.4 mm) backer panel.

OVERLAY PANEL SPECIFICATION

Depending on your cabinet manufacturer, this could be one panel routed for different dimensions or, more likely, three different panels.

Use the same Panel dimensions for Single and Side by Side installations.

The door panel weight must not exceed 25 lb (11.3 kg) per door.

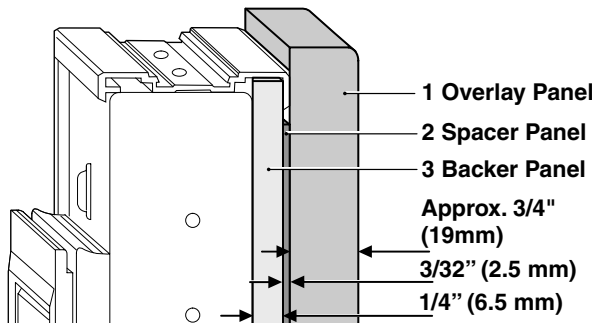

Single and Side-by-Side Installation

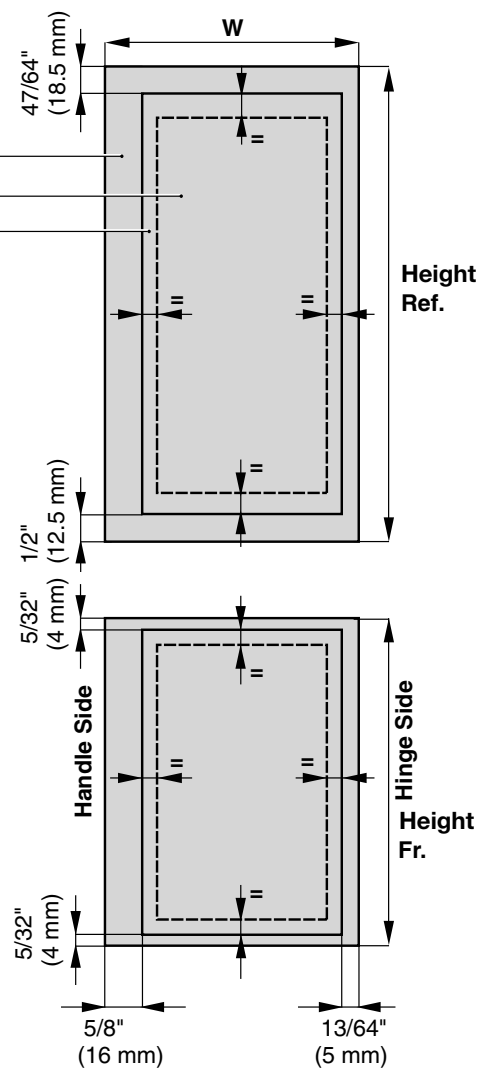

| | W | H - Refrigerator | H - Freezer |
|------------------------|-----------------------|------------------------|-----------------------|
| 1 Overlay Panel | 29-7/32" (742 mm) | 47-33/64" (1207 mm) | 29-1/4" (743 mm) |
| 2 Spacer Panel | 27-9/16" (700 mm) | 45-9/32" (1150 mm) | 27-29/32" (709 mm) |
| 3 Backer Panel | 28-25/64" (721 mm) | 46-19/64" (1176 mm) | 28-15/16" (735 mm) |



Accessories for Framed and Overlay Panels

Kits may be necessary to reverse the door and hinges, complete this unit's installation or to apply it in a different manner than its original intent. If a kit is necessary, contact your Liebherr retailer or distributor.
All installation materials for accessories are included with the kits.

The following kits are available:

For Single 30" Unit Installation CI 1601, CI 1650, CI 1651

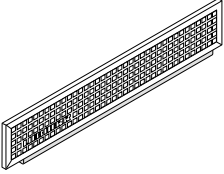
Optional installation accessory

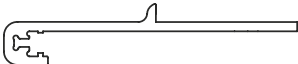
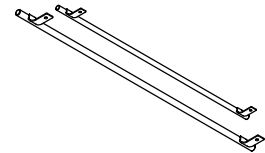
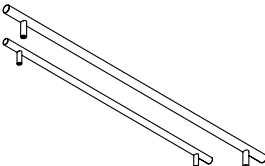
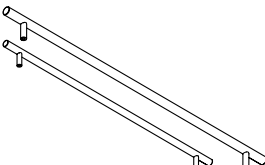
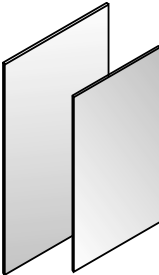
| | | |
|---|---------|---|
|  | 9900825 | Top Ventilation Grille C/CI16 |
|  | 9900809 | Reverse Set - CI 16 from R to L For reversing doors and hinges from R to L |
|  | 9900807 | Reverse Set - CI 16 from L to R For reversing doors and hinges from L to R |
|  | 9900817 | Handles - Trim Kit for framed panels. Made of stainless steel Diameter : 23/32" (18 mm) Length: 46-1/2" (1181 mm) and 42-3/4" (1086 mm) |
|  | 9900819 | Handles for overlay panels Made of stainless steel Diameter: 3/4" (18mm) Length: 13-3/4" (350 mm), both |
|  | 9900821 | Handles for overlay panels Made of stainless steel Diameter: 1" (25mm) Length: 17-3/4" (450 mm) and 13-3/4" (350 mm) |
|  | 9900823 | Panels Made of Stainless Steel Brushed Horizontally Includes filler with total thickness of 1/4" - Ready to assemble Width: 28-1/4" (717 mm) Length: 46-5/16" (1176 mm) and 28-7/8" (735 mm) Thickness: 1/4" (6.4 mm) including filler |

For Side-by-Side 60" Unit Installation SBS 3210

Standard installation accessory

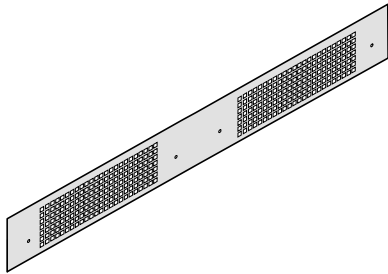

9900827

Side by Side-Kit SBS 320 & 3210
incl. bottom ventilation grille.

Optional installation accessory

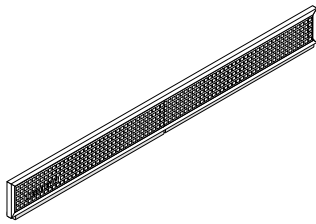

9900829

Top Ventilation Grille SBS 320 & 3210

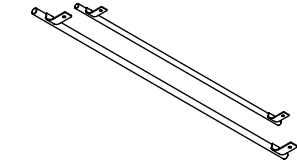

9900817 (order 2)

Handles - Trim Kit for framed panels.

Made of stainless steel
Diameter : 23/32" (18 mm)
Length: 46-1/2" (1181 mm) and
42-3/4" (1086 mm)

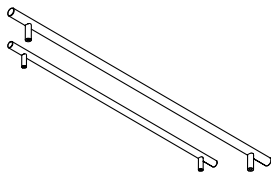

9900819 (order 2)

Handles for overlay panels

Made of stainless steel
Diameter: 3/4" (18mm)
Length: 13-3/4" (350 mm), both

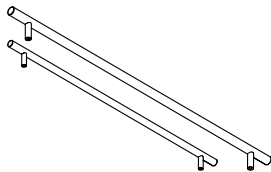

9900821 (order 2)

Handles for overlay panels

Made of stainless steel
Diameter: 1" (25mm)
Length: 17-3/4" (450 mm) and
13-3/4" (350 mm)

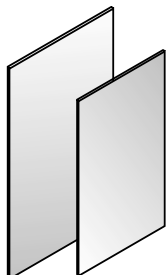

9900823 (order 2)

Panels
Made of Stainless Steel Brushed Horizontally
Includes filler with total thickness of 1/4"
- Ready to assemble

Width: 28-1/4" (717 mm)
Length: 46-5/16" (1176 mm) and
28-7/8" (735 mm)

Door Swing Clearance 130° CI Models

The factory setting for the door to swing open is 130° but can be set to 90° if desired. Use this illustration to ensure other cabinets or counters do not interfere with the door opening.

Frameless cabinets: The casing trim overlaps the cabinets at the side and top. Cabinets may require filler strips to prevent interference with the cabinet door swing. The door opening must allow for filler strips.

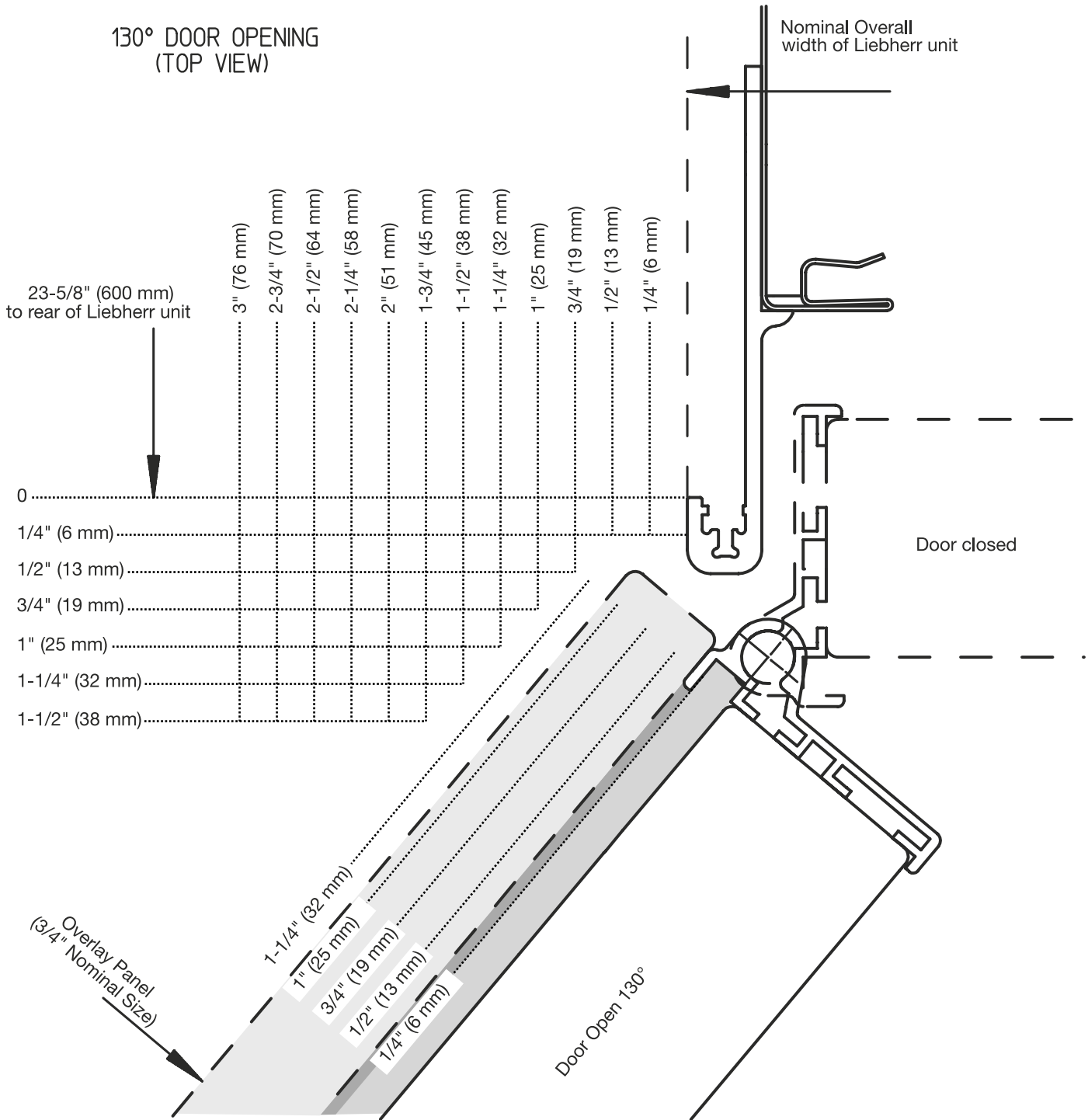

Scale 1:1

Door Swing Clearance 90° CI Models

You may require a 90° door stop to avoid interference with neighbouring cabinets and door panels. You can change the door swing stop from 130° to 90° by changing the supplied hinge pin.

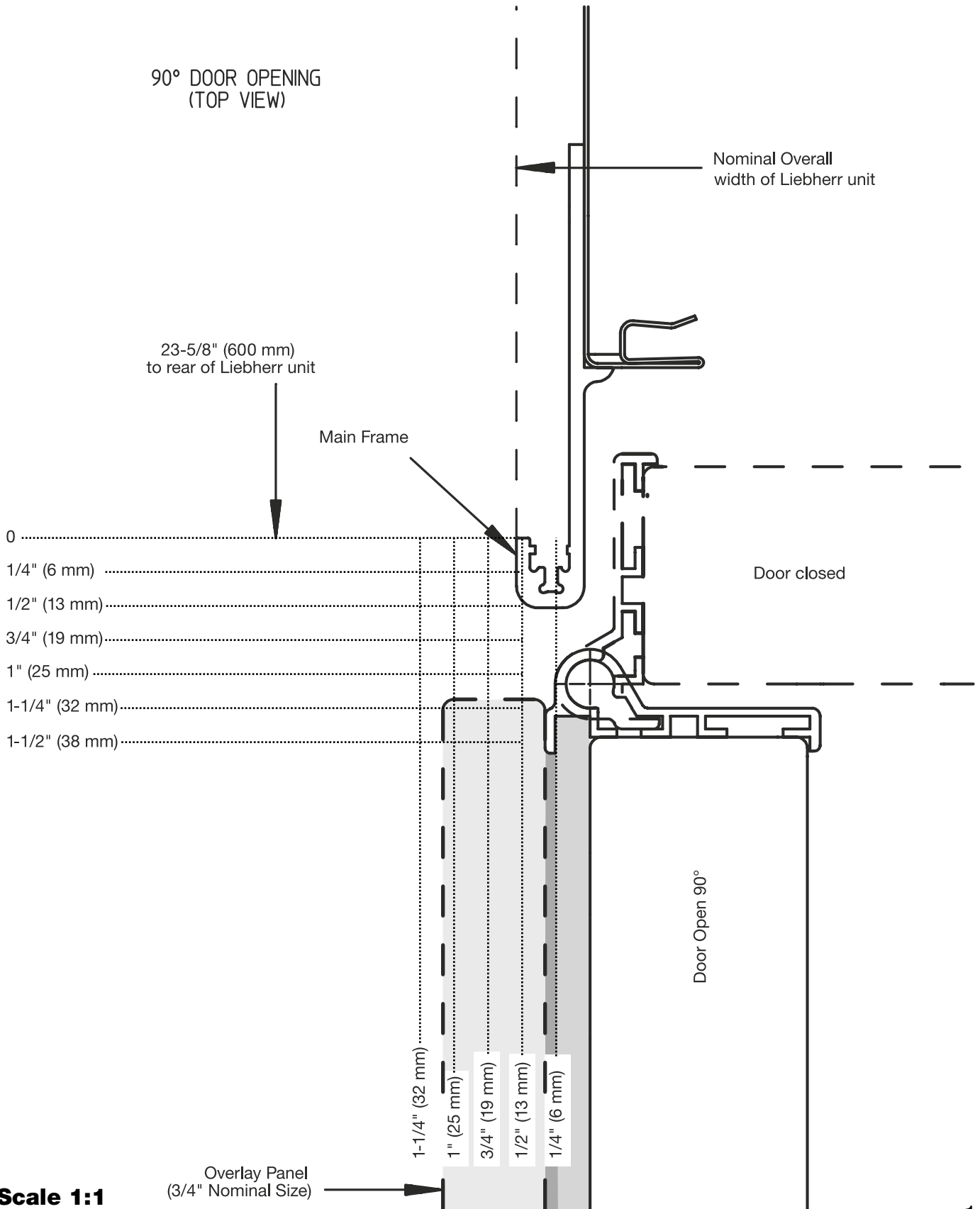

Scale 1:1

Stainless steel C 1601, C 1650, C 1651, SBS 320

The Liebherr refrigerator-freezer with stainless steel doors can be easily integrated into any kitchen layout. The stainless steel gives a more professional style and it is easily cleaned. No panels are required.

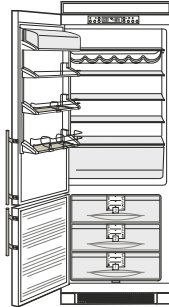
**C 1601**

| | |
|---------------------------|--------------------|
| Energy Star: | qualified |
| Energy consumption p. a.: | 460 kWh |
| Energy Supply: | 115V/60Hz/350W |
| Total capacity: | 15.5 cu ft (438 L) |
| Refrigerator: | 11.3 cu ft (320 L) |
| Freezer: | 4.2 cu ft (118 L) |
| Climate Rating: | SN-T |
| Door hinges: | left / reversible* |

- Automatic refrigerator defrosting
- Automatic freezer compartment defrosting

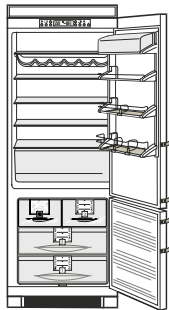
**C 1650, 1651**

| | |
|---------------------------|---------------------|
| Energy Star: | qualified |
| Energy consumption p. a.: | 460 kWh |
| Energy Supply: | 115V/60Hz/350W |
| Total capacity: | 15.4 cu ft (436 L) |
| Refrigerator: | 11.3 cu ft (320 L) |
| Freezer: | 4.1 cu ft (116 L) |
| Ice cube capacity: | 2.2 pd./24h |
| Ice cube stock: | 3.3 pd. |
| Climate Rating: | SN-T |
| Door hinges: | right / reversible* |
| Model C 1651: | left / reversible* |

- Automatic refrigerator defrosting
- Automatic freezer compartment defrosting
- Automatic IceMaker can be switched off

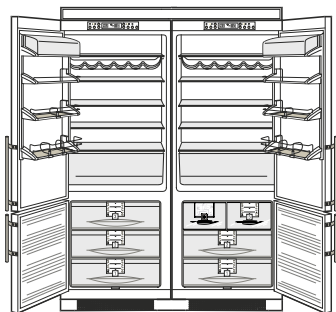
**SBS 320 (C 1601 & C 1650)***

| | |
|--------------------|----------------------------|
| Energy Supply: | 115V/60Hz/700W |
| Total capacity: | 30.9 cu ft (874 L) |
| Refrigerator: | 22.6 cu ft (640 L) |
| Freezer: | 8.3 cu ft (234 L) |
| Ice cube capacity: | 2.2 pd./24h |
| Ice cube stock: | 3.3 pd. |
| Climate Rating: | SN-T |
| Door hinges: | left / right / reversible* |

- Automatic refrigerator defrosting
- Automatic freezer compartment defrosting
- Automatic IceMaker can be switched off

* optional reverse door kit required

Accessories

Kits may be necessary to reverse the door and hinges, complete this unit's installation or to apply it in a different manner than its original intent. If a kit is necessary, contact your Liebherr retailer or distributor.

The following kits are available:

For Single 30" Unit Installation C 1601, C 1650, C 1651

Optional installation accessory

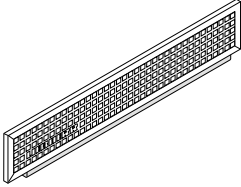
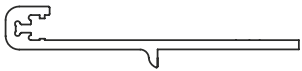
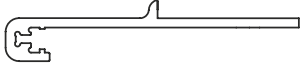
| | | |
|---|---------|--|
|  | 9900825 | Top Ventilation Grille C/CI16 |
|  | 9900699 | Reverse Set - C 16 from R to L For reversing doors and hinges from R to L |
|  | 9900697 | Reverse Set - C 16 from L to R For reversing doors and hinges from L to R |

For Side-by-Side 60" Unit Installation SBS 320

Standard installation accessory

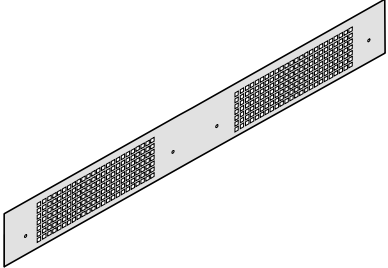
| | | |
|---|---------|---|
|  | 9900827 | Side by Side-Kit SBS 320 Bottom ventilation grille |
|---|---------|---|

Optional installation accessory

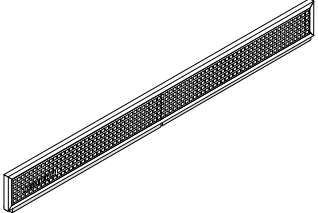
| | | |
|---|---------|--------------------------------|
|  | 9900829 | Top Ventilation Grille SBS 320 |
|---|---------|--------------------------------|

Door Swing Clearance 130° C Models

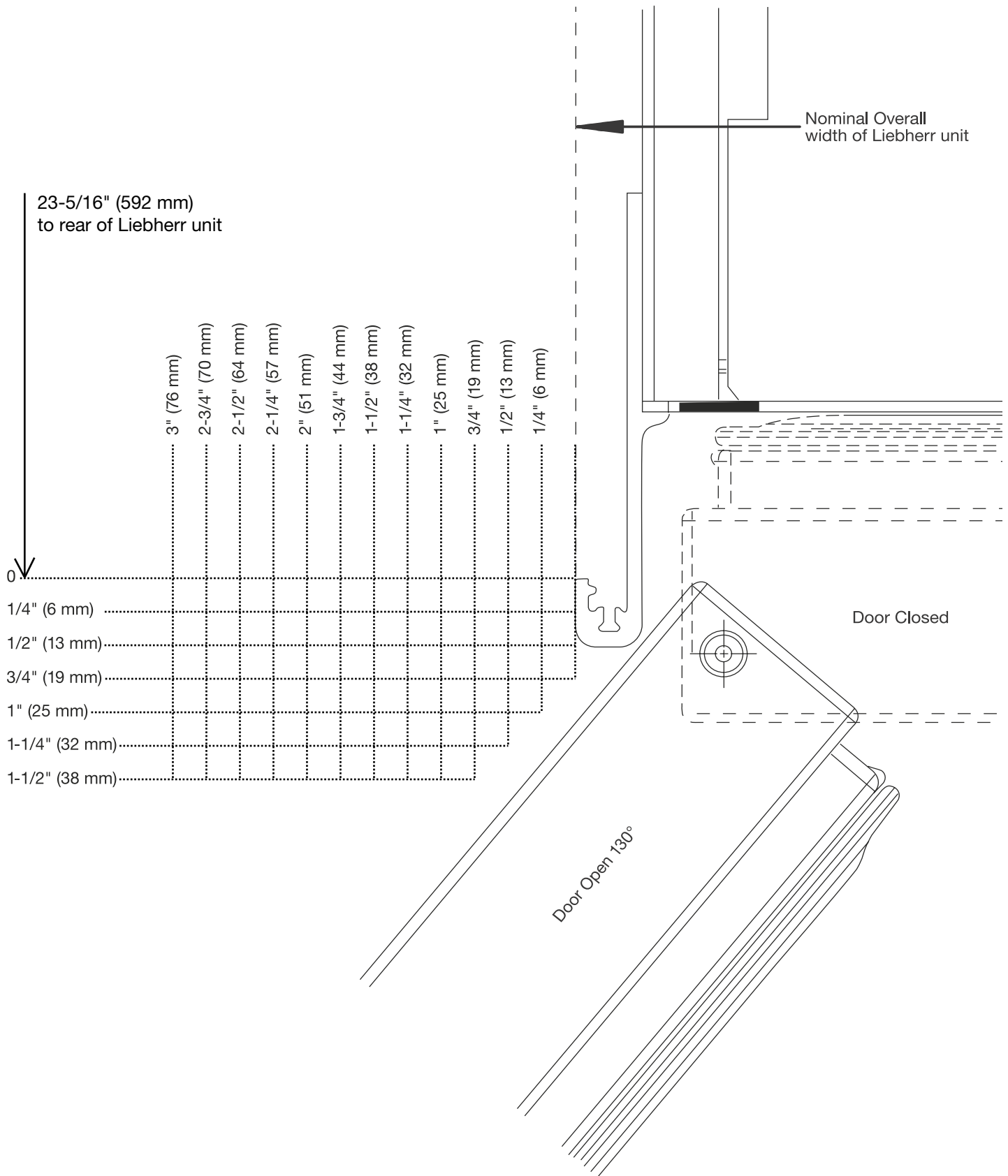

Scale 1:1

Door Swing Clearance 90° C Models

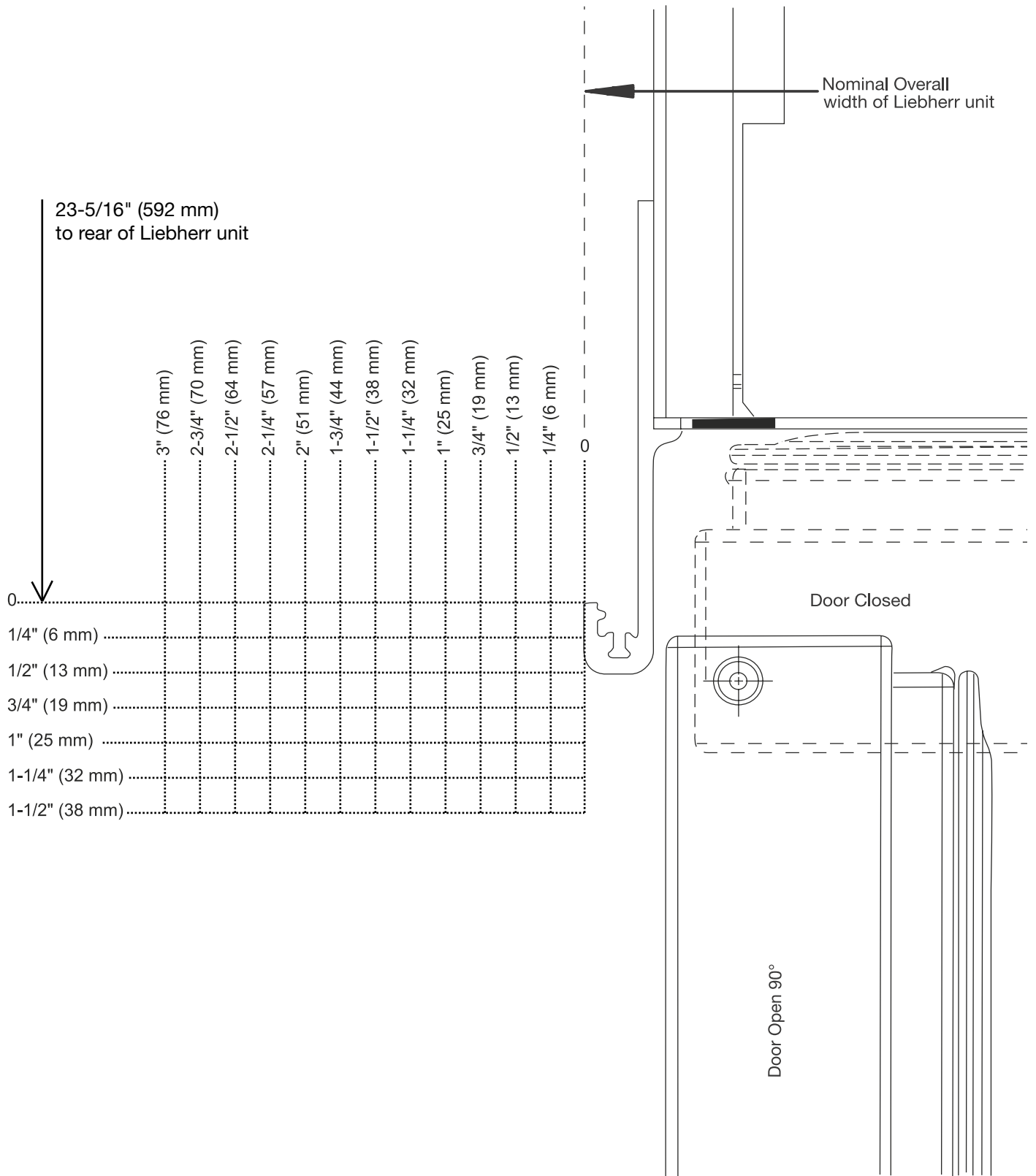

Scale 1:1

LIEBHERR

Design Guide 2008