

SAFETY IS EVERYONE'S RESPONSIBILITY. ALL DACOR APPLIANCES ARE DESIGNED AND CONSTRUCTED TO GIVE YOU MANY YEARS OF SAFE OPERATION. THE OPERATION WILL BE FURTHER ENHANCED IF PROPER CARE AND JUDGEMENT ARE EXERCISED IN THE USE AND MAINTENANCE OF THIS APPLIANCE.

IMPORTANT INFORMATION

- Operating Instructions
- Care and Cleaning Instructions
- Safety Tips



WARNINGS:

Must be followed carefully to avoid personal injury or damage.



NOTES:

Contains helpful hints and tips.

Please Read Before Using Your Cooktop

Place Serial Number Label Here



To Our Valued Customer:

Congratulations on your purchase of the very latest in Dacor® products! Our unique combination of features, style and performance make us The Life of the Kitchen™, and a great addition to your home.

In order to familiarize yourself with the controls, functions, and full potential of your new Distinctive Appliance, we suggest that you thoroughly read this use and care manual, beginning with the **Important Safety Instructions** section.

All Dacor appliances are designed and manufactured with quality and pride, while working within the framework of our company value. Should you ever experience a problem with your product, please first check the **Before You Call for Service** section of this manual for guidance. It provides useful suggestions and remedies prior to calling for service.

Valuable customer input helps us to continuously improve our products and services, so please feel free to contact our Customer Service Team for assistance with any of your product support needs.

Dacor Customer Service Team
1440 Bridge Gate Drive
Diamond Bar, CA 91765

Telephone: (800) 793-0093

Fax: (626) 403-3130

Hours of Operation: Monday through Friday
6:00 A.M. to 5:00 P.M. Pacific Time

Web Site: www.Dacor.com

Thank you for choosing Dacor for your home. We are a company built by families for families and we are dedicated to serving yours. We are confident that your new Dacor product will deliver a high level of performance and enjoyment for many years to come.

Sincerely,

Cheryl Crowe
Director, Customer Satisfaction

TABLE OF CONTENTS	1
Purpose of this Manual	1
Product Registration.....	1
IMPORTANT INSTRUCTIONS	1
What To Do	1
What Not To Do.....	1
COOKTOP OPERATION	2-3
Getting Started.....	2
Heating Elements.....	2
Residual Heat Indicator Lights	2
Element ON Indicator Light.....	2
Setting the Controls.....	2-3
Selecting the Proper Cookware	3
CARE AND CLEANING	3
PROBLEM SOLVING	4
Troubleshooting	4
Product Maintenance	4
If You Need Service.....	4
PRODUCT WARRANTY	4
What Is Covered	4
What Is Not Covered.....	4

Purpose of This Manual

This **use and care manual** is designed to enable you to properly operate and maintain your new cooktop. Please keep this manual handy for easy access and quick reference.

Additional information may be requested by e-mailing, writing or phoning the DACOR Customer Service Team. The address and phone number of this department are listed on the inside front cover of this manual.

What to Do

1. Begin by insuring proper installation and grounding of the appliance by a qualified technician. Have the installer show you where the fuse or junction box is located so that you know how and where to turn off power.
2. Never let clothing, potholders or other flammable materials come in contact with the burners while in operation. Fabric may ignite and result in personal injury. For personal safety wear proper apparel; loose fitting or hanging garments should never be worn while cooking.
3. Always use pot holders when removing utensils from the cooktop elements. Wet or damp pot holders can cause steam burns. Do not use a towel or bulky cloth in place of pot holders.
4. Select utensils of the proper size, material and construction for the particular type of cooking being done. Choose cookware with a flat bottom that closely matches the diameter of the heating element. Select pans with easily grasped handles that will stay cool during cooking. Avoid using pans that are too heavy to lift safely. Do not use utensils with loose handles. Use cookware only as it is intended. Certain types of glass, ceramic, and earthenware utensils are suitable for use only in an oven and not in cooktop applications.
5. Always turn pan handles to the side or back of the range. Do not turn handles towards the room where they are easily hit. Handles should not extend over adjacent heating elements.
6. Always clean the cooktop cautiously. If using a damp sponge or cloth, wait until the cooktop has cooled sufficiently to prevent steam burns. Also, some cleaners can produce noxious fumes when applied to hot surfaces.

What Not to Do

1. Never use your cooktop to warm or heat the room.
2. When using the cooktop: **DO NOT TOUCH THE GLASS SURFACE** directly above or adjacent to the heating elements. The glass surface may become hot enough to cause burns.
3. Do not leave children or pets alone or unattended in the area where the cooktop is in use. They should never be allowed to sit or stand on the appliance. Do not let children play with the cooktop.
4. **CAUTION:** Do not store items of interest to children above or at the back of the cooktop – they could climb on it to reach the items and be seriously injured.
5. Do not repair or replace any part of the appliance unless it is specifically recommended in literature you received. All servicing should be referred to a qualified technician.
6. Do not use water on grease fires. Smother the flame, or use a dry chemical or foam-type extinguisher.
7. Never leave burners unattended when using high heat settings. Boil-overs and greasy spill-overs may smoke and/or ignite.
8. Do not operate the cooktop if the ceramic glass top is broken or severely pitted. Call a qualified technician to repair the appliance.
9. Do not store flammable materials near hot components or let grease or other flammable substances accumulate on the cooktop.
10. Do not allow pans to boil dry or use the cooktop as a counter to store utensils or other items. Doing so can damage the items, the elements and/or the cooktop.
11. Do not place objects, other than cooking utensils, on top of the cooktop. Do not use this appliance as a shelf or table.

If you received a damaged product, immediately contact your dealer or builder. Do not install or use a damaged appliance.

 **WARNING:** NEVER use this appliance as a space heater or to warm a room. Doing so may result in overheating of the appliance.

Product Registration

 Please enter the information requested in the spaces provided below. This information will be required in the unlikely event that a service call becomes necessary:

Model No. _____ Serial No. _____

Date Purchased _____ Date Installed _____

Purchased From _____

Address _____

Phone _____

Getting Started

Before operating the cooktop, clean the glass ceramic surface carefully as outlined in the Care and Cleaning Instructions. The cooktop surface must be free of any foreign substances, especially those that could melt and permanently adhere to the glass.

During the first uses of your new cooktop, you may smell a slight burning odor or see light smoke. Both of these conditions are normal in new glass ceramic cooktops.

Heating Elements

Dacor glass ceramic cooktops contain ribbon type radiant heating elements in various sizes to allow the user the greatest cooking flexibility.

The Ribbon Radiant Heaters illuminate within approximately 3-4 seconds of activation. The Dual Element consists of two elements which may be operated simultaneously for heavy cooking demands. The inner element may be operated alone for improved simmering with smaller utensils.

All elements feature temperature limiters to ensure that the safe operating temperature of the glass ceramic top is never exceeded.

Dacor glass ceramic cooktops operate by automatically cycling the heating elements between "off" and full power. As the numeric setting of the control is increased, the element will stay at full power for longer periods and at zero power for shorter durations.

When the element is set to the dual range, both the inner and outer elements will cycle on and off at the same time. (The outer heating element can never be operated alone.)

For maximum performance from any burner remember to closely match heating element diameters and cookware size.

Residual Heat Indicator Lights

All Dacor glass cooktops have element residual heat indicator lights. These indicating lights remain illuminated until the burner cools down to a safe temperature of 140°F.

IMPORTANT:

Be certain that the cookware and glass surfaces are clean and dry before you turn on the burner and place a pot or pan on the heating burner.

Element ON Indicator Light

One light indicating power is on to any of the elements.

Setting the Controls

NOTE:

When at its highest setting, the heating element may cycle off due to the protection of the temperature limiter built into each element. This temperature limiting occurs automatically to prevent exceeding the maximum allowable surface temperature and to maintain the constant desired heat level. The element will cycle back on after it has cooled to a safe temperature.

Models ETT304-1 and ETT365-2

To turn an element on, tap the "ON/OFF" key then tap the up arrow for the desired element. The element will come on at a setting of "5" and may be adjusted up or down by pressing the appropriate key.

To activate the Dual Element, tap the "ON/OFF" key then tap the Dual Element Indicator to activate the outer ring of the element. It will come on at a setting of "5", then tap the up indicator for desired temperature setting.

To turn an element off, tap the "ON/OFF" key. You may turn off all active elements at the same time by tapping twice on the Dacor logo located below the controls.

ETT304-1 and ETT365-2 Secure Lockout

To avoid accidentally turning the cooktop on while cleaning it, activate the "Secure Lockout" feature.

To lock out the cooktop:

Press and hold the Dacor logo for 3-4 seconds and the cooktop will be secured from use. You will hear three beeps and a light will illuminate directly above the Dacor logo indicating that the cooktop is secure. The control panel is now disabled and may be cleaned without activating any functions.

To unlock the cooktop:

Press and hold the Dacor logo for 3-4 seconds. You will hear three beeps and the light will go out. The control panel is now ready for use.

NOTES:

1. **For maximum safety, the cooktop will be in the "lock out" mode when first installed, or whenever power is interrupted. Follow the "Unlock" instructions above to reactivate the control panel.**
2. **To turn off multiple burners all at one time - tap the Dacor logo twice.**

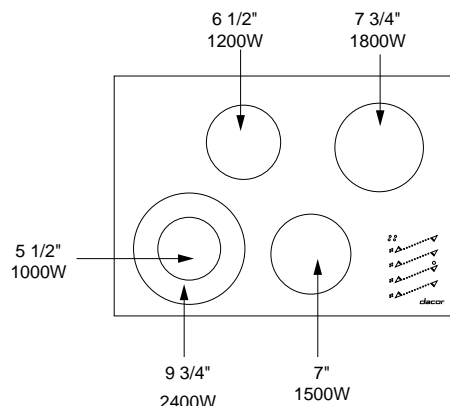

Model ETT304-1
Top View

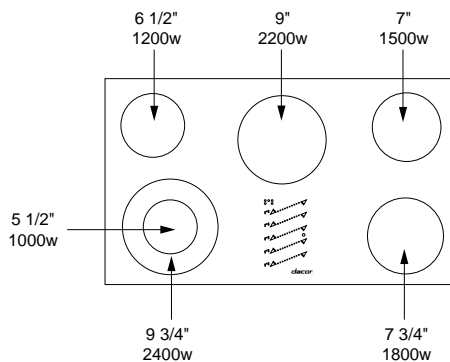

Model ETT365-2
Top View

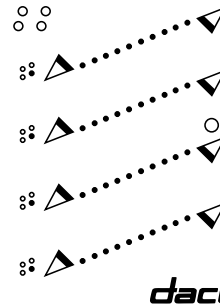

ETT304-1 and ETT365-2 Controls

MET Models

To turn the element on, tap the "ON/OFF" key then glide your finger across the settings below the numbers which correspond to the element power. At any time while the element is on, you may glide your finger up or down the scale to adjust its heat.

The dual element, located in the front left burner, can be activated after the "ON/OFF" key has been pressed. At any time during the cooking process, the small dual element indicator can be tapped to turn the element on or off. It will illuminate when the outer ring is activated.

To turn an element off, tap the Cancel/ Secure key. You may turn off all active elements at the same time by tapping twice on the Dacor logo below the controls.

MET Secure Lockout

To avoid accidentally turning the cooktop on while cleaning it, activate the "Secure Lockout" feature.

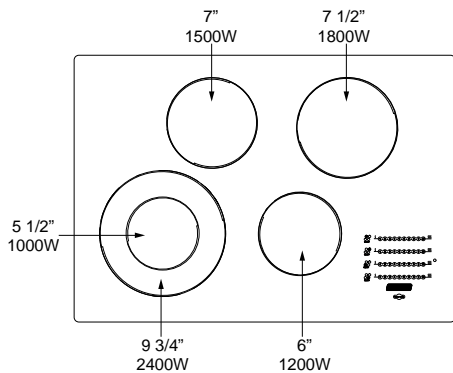

Model MET304: Top View

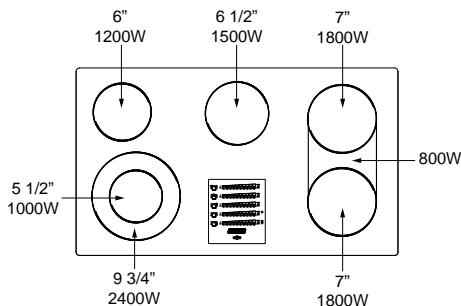

Model METB365-1: Top View

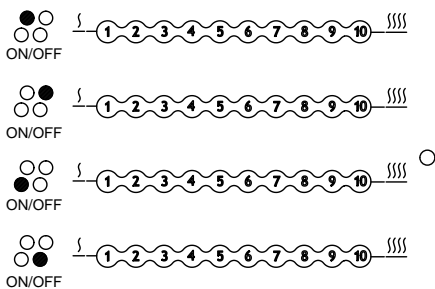

CANCEL • SECURE

MET304 and METB365-1 Controls

Bridge Burner (METB365-1 Only)

The METB365-1 electric cooktop offers a convenient cooking feature. The bridge burner has controlled heat zones allowing various pot and pan applications on this three-in-one burner. The bridge burner has three cooking zones identified by the lines on the right side of the cooktop. Each zone has a separate heating element. In the front of the bridge is a round element seven inches in diameter that is rated at 1800 watts. This front element of the bridge burner is individually controlled for use with a pot or pan as large as eight inches in diameter. The back burner area of the bridge burner, also a round element seven inches in diameter, is rated 1800 watts makes this another great individual burner for a pot as large as eight inches in diameter. In the center of the bridge burner is a bridge element rated at 800 watts, which operates in conjunction with the back burner element.

To turn the bridge element on, select the front right control and the back right control. Tap the "ON/OFF" keys then glide your finger across the settings to the desired temperature. Tap the BRIDGE BURNER ICON on the right side of the bottom slide control. This will activate the middle bridge element and can be turned on or off by pressing this icon while the burner is on. The heat of the bridge element is controlled along with the front element.

Note: Ask your dealer about the DACOR AMG11 Griddle. This Griddle is designed for the DACOR bridge burner. **DO NOT BRIDGE A GRIDDLE ACROSS TWO BURNERS UNLESS YOU HAVE THE METB BRIDGE ELEMENT.** Bridging across two elements will create stress on the cooktop which can result in cracking.

Selecting Proper Cookware

For best results, a few simple guidelines should be followed: use medium to heavy gauge metal cookware with flat, thick and smooth bottoms for greatest efficiency. Glass cookware should only be used as recommended by the cookware manufacturer

IMPORTANT:

In no instance should a support, such as a wok ring or trivet, be placed directly on the cooking surface. This may result in scratching of the glass ceramic top.

WARNING:

To avoid electrical shock or burns, turn off all controls and ensure the cooktop is cool before cleaning.

IMPORTANT:

Do not use harsh or abrasive cleaning agents, waxes, polishes, or commercial cooktop cleaners to clean the cooktop.

Accessories

AMG 11: Griddle has non-stick coating for easy cleaning. This griddle is a perfect addition for your bridge burner.

For accessories call your DACOR dealer.

Care and Cleaning Instructions

Glass Ceramic Top

Clean the top surface thoroughly before operating the cooktop for the first time. Apply about 1/4 teaspoon of non-abrasive cleaner, such as the Cooktop Cleaning Creme supplied, to the surface of the ceramic glass with a lightly dampened clean cloth. Use a second clean cloth to remove any remaining cleaner residue. Wipe the cooktop surface with a dry cloth to completely eliminate any remaining moisture.

The cooktop surface should be maintained by repeating the above procedure during or after each use. Be careful not to wipe or clean any hot areas to avoid personal injury. It should be safe to clean each element area whenever the corresponding element residual heat indicator light has gone out.

To remove heavy or burned-on spills, allow the cooktop to cool. Using a razor blade scraper held at a 30° angle to the cooktop surface, gently scrape off any burned-on substances. Remove any remaining residue by applying the recommended cleaner as described above. Be careful not to scratch or gouge the surface. Do not allow the scraper handle to touch the cooktop surface when hot. Remove any residue by applying the recommended cleaners.

Pitting of the ceramic glass is possible if sugar spills or spills with a high sugar content are left in the hot zone. Use a razor scraper to move the spill to a cool area for cleaning after the cooktop cools.

Product Maintenance

No maintenance, other than the **CARE AND CLEANING INSTRUCTIONS** identified in this **Use & Care Manual**, should be attempted by the owner/operator. All other maintenance and service must be performed by a qualified appliance technician.

WARNING:

To prevent injury or permanent damage to the cooktop, avoid:

1. Using the cooktop as a cutting board.
2. Sliding rough-bottomed cookware, especially aluminum, across the glass surface. (Remove any resulting marks immediately, using the recommended cleaner if this occurs.)
3. Allowing anything that melts easily, such as plastic objects, aluminum foil, sugar, and foods with high sugar content, to directly come in contact with the glass surface. In the event that this condition occurs, remove from hot zone immediately with the razor scraper.
4. Placing food directly on the cooktop surface when it is warm or hot. (Always use cookware.)
5. Operating or cleaning the cooktop if the glass is broken. (Immediately contact an authorized service technician.)
6. Placing a trivet, wok support ring, or other metal stand directly onto the glass surface.
7. Applying chlorine bleach, ammonia, or other strong chemicals or cleaners such as Windex or Formula 409 to the cooktop.
8. Using abrasive cleaners or applicators.
9. Mixing various chemicals or cleaners together, then applying them to the cooktop.
10. Wiping the cooktop with a sponge or dish cloth which may leave a film of detergent that will discolor during the next heating cycle. (Remove any resulting discoloration using the recommended cleaner if this occurs.)

Troubleshooting

Unnecessary service calls may be expensive, frustrating and time consuming. Before you call for service, please review the potential problems, possible causes and remedies shown in the table below.

Problem	Possible Cause	Remedy
Nothing works.	Cooktop not connected to proper electrical circuit.	Have electrician verify that the proper rated cooktop voltage is being supplied to the cooktop.
	Fuse is blown or circuit breaker is tripped.	Have electrician replace fuse or reset circuit breaker.
	No electricity to the cooktop.	Have electrician check your power supply.
	Cooktop is in lockout mode.	Unlock the cooktop.
Heating elements do not heat properly.	Cooktop is connected to 120 volt power supply.	Have electrician connect cooktop to the proper rate cooktop voltage.
	Power supply connection is loose.	Have electrician tighten the connections at the junction box.
	Improper cookware is being used.	Select proper cookware as outlined in the Cooktop Operation section of this manual.
Heating elements cycle off even when elements are turned to their highest settings.	Heating element temperature limiters are temporarily shutting off the elements due to exceeding the maximum allowable temperature.	This is a normal operating condition, especially during rapid heat-up operations. The element will cycle back on automatically after it has cooled sufficiently.
Glass ceramic surface is see-through or appears to be red in color.	Under direct or bright lighting, you will sometimes be able to see through the glass and into the chassis due to its transparent quality. You may also notice a red tint under these conditions.	These are normal properties of black ceramic glass panels.

If You Need Service...

First, review the recommended checks listed in the preceding **Troubleshooting Guide**. Then, be certain that the appliance has been installed properly and is being operated correctly. Familiarize yourself with the warranty terms and conditions listed in the **PRODUCT WARRANTY** section.

If the above checks have been completed and the problem has not yet been remedied, call your local authorized DACOR service representative. Your dealer can normally provide the name and telephone number of the nearest service company.

DACOR works diligently to ensure your satisfaction when service is necessary. However, if you are not completely satisfied with the service provided, contact the company that performed the service and express why you are not pleased. Normally, they will be willing and able to resolve the problem.

If the service agency is not able to respond effectively, call or write the DACOR Customer Service Department. The phone number and address of this department are listed on the inside front cover of this manual. Please include your telephone number if you choose to write. We will then do our utmost to assure your happiness and satisfaction.

What Is Covered

CERTIFICATE OF WARRANTIES
DACOR COOKTOPS

WITHIN THE FIFTY STATES OF THE U.S.A., THE DISTRICT OF COLUMBIA AND CANADA*:

FULL ONE-YEAR WARRANTY

If your DACOR product fails to function within one year of the original date of purchase, due to a defect in material or workmanship, DACOR will remedy the defect without charge to you or subsequent users. The owner must provide proof of purchase, upon request, and have the appliance accessible for service.

* Warranty is null and void if non-CSA approved product is transported from the U.S.

OUTSIDE THE FIFTY STATES OF THE U.S.A., THE DISTRICT OF COLUMBIA AND CANADA:

LIMITED FIRST YEAR WARRANTY

If your DACOR product fails to function within one year of the original date of purchase, due to a defect in material or workmanship, DACOR will furnish a new part, F.O.B. factory, to replace the defective part. All delivery, installation and labor costs are the responsibility of the purchaser. The owner must provide proof of purchase, upon request, and have the appliance accessible for service.

What Is Not Covered

- Service calls to educate the customer in the proper use and care of the product.
- Failure of the product when used for commercial, business, rental or any application other than for residential consumer use.
- Replacement of house fuses or fuse boxes, or resetting of circuit breakers.
- Damage to the product caused by accident, fire, flood or other acts of God.
- Breakage, discoloration or damage to glass, metal surfaces, plastic components, trim, paint, or other cosmetic finish, caused by improper usage or care, abuse, or neglect.

THE REMEDIES PROVIDED FOR IN THE ABOVE EXPRESS WARRANTIES ARE THE SOLE AND EXCLUSIVE REMEDIES. THEREFORE, NO OTHER EXPRESS WARRANTIES ARE MADE, AND OUTSIDE THE FIFTY STATES OF THE UNITED STATES, THE DISTRICT OF COLUMBIA AND CANADA, ALL IMPLIED WARRANTIES, INCLUDING BUT NOT LIMITED TO, ANY IMPLIED WARRANTY OF MERCHANTABILITY OR FITNESS FOR A PARTICULAR USE OR PURPOSE, ARE LIMITED IN DURATION TO ONE YEAR FROM THE DATE OF ORIGINAL PURCHASE. IN NO EVENT SHALL DACOR BE LIABLE FOR INCIDENTAL EXPENSE OR CONSEQUENTIAL DAMAGES. NO WARRANTIES, EXPRESS OR IMPLIED, ARE MADE TO ANY BUYER FOR RESALE.

Some states do not allow limitations on how long an implied warranty lasts, or do not allow the exclusion or limitation of inconsequential damages, so the above limitations or exclusions may not apply to you. This warranty gives you specific legal rights, and you may also have other rights that vary from state to state.

fold here

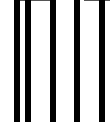

NO POSTAGE
NECESSARY
IF MAILED
IN THE
UNITED STATES

BUSINESS REPLY MAIL
FIRST-CLASS MAIL PERMIT NO. 4507 DIAMOND BAR CA

POSTAGE WILL BE PAID BY ADDRESSEE

DACOR INC.
ATTN: WARRANTY PROCESSING DEPT
1440 BRIDGE GATE DR STE 200
PO BOX 6532
DIAMOND BAR CA 91765-9861

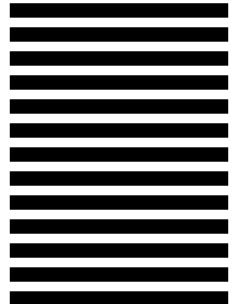



Please visit www.Dacor.com to activate your warranty online.

WARRANTY INFORMATION



IMPORTANT:

Your warranty will not be activated until you activate it online or return this form to Dacor. If you have purchased more than one Dacor product, please return all forms in one envelope or activate the warranty for each product online.

Please rest assured that under no conditions will Dacor sell your name or any of the information on this form for mailing list purposes. We are very grateful that you have chosen Dacor products for your home and do not consider the sale of such information to be a proper way of expressing our gratitude!

Owner's Name: _____
Last (Please Print or Type) First Middle

Street: _____

City: _____ State: _____ Zip: _____

Purchase Date: _____ Email: _____ Telephone: _____

Dealer: _____

City: _____ State: _____ Zip: _____

Your willingness to take a few seconds to fill in the section below will be sincerely appreciated. Thank you.

1. How were you **first** exposed to Dacor products? (Please check one only.)

- A. T.V. Cooking Show
- B. Magazine
- C. Appliance Dealer Showroom
- D. Kitchen Dealer Showroom
- E. Home Show
- F. Builder
- G. Architect/Designer
- H. Another Dacor Owner
- I. Model Home
- J. Other _____

2. Where did you buy your Dacor appliances?

- A. Appliance Dealer
- B. Kitchen Dealer
- C. Builder Supplier
- D. Builder
- E. Other _____

3. For what purpose was the product purchased?

- A. Replacement **only**
- B. Part of a Remodel
- C. New Home
- D. Other _____

4. What is your household income?

- A. Under \$75,000
- B. \$75,000 – \$100,000
- C. \$100,000 – \$150,000
- D. \$150,000 – \$200,000
- E. \$200,000 – \$250,000
- F. Over \$250,000

5. What other brands of appliances do you have in your kitchen?

- A. Cooktop _____
- B. Oven _____
- C. Dishwasher _____
- D. Refrigerator _____

6. Would you buy or recommend another Dacor product?

- Yes
- No

Comments: _____

Thank you very much for your assistance. The information you have provided will be extremely valuable in helping us plan for the future and giving you the support you deserve.

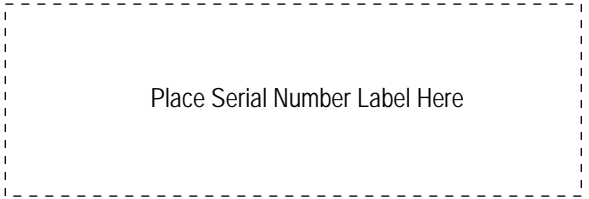

cut here