



Échelon Series

Use and Care Guide

**Clear Ice Maker Model:
CLR2160**

**Clear Combo® Ice Maker/Refrigerator
Model:
CLRCO2175**



CLR2160



CLRCO2175

1 Introduction

Congratulations on your purchase of a U-Line refrigeration product. A pioneer in the field for more than 40 years, U-Line Corporation is the world's number one manufacturer of built-in, under-counter, specialty refrigeration and ice making products. U-Line dedicates 100% of its research and development to these products. The result: U-Line technology consistently leads the market with innovation, design, depth of product line and performance.

U-Line products are making life more convenient in homes, businesses, and hotels around the world. U-Line supports its products with a strong dealer network, and its commitment to quality even extends to environmentally safe packaging.

IMPORTANT

READ all of the instructions in this guide completely before operating the unit for the first time.

For future reference, keep this guide in a safe, accessible location. If you need additional information or assistance, please contact U-Line Corporation directly. Contact information appears on the rear cover of this guide.

If you have a problem with the operation of this product, the SERVICE section of this guide will assist you in quickly identifying common problems and provide information on possible causes and remedies. If your product needs service, contact U-Line directly.

Warranty Registration

Your U-Line Corporation Limited Warranty is located on the inside rear cover of this guide. To validate your warranty, the product and its original purchase date must be registered. A Warranty Registration Card has been included for this purpose in the package containing this manual. Complete and mail the Warranty Registration Card, or register your product online at www.U-LineService.com as soon as possible after purchase.

If your product registration is not on file and a request for warranty coverage is received, the date of sale to the U-Line Selling Dealer or Distributor will be established as the first date of warranty coverage for your product.

Please Record Your Model Information

When you request additional information or service, you will be asked for your products model and serial numbers. You can find this information on the serial plate located on the upper right or rear wall in the interior of your unit. This information also appears on the warranty registration card.



Figure 1

Please record the model number (**Figure 1, 1**), serial number (**Figure 1, 2**), date of purchase, and dealer contact information for your U-Line product below:

Model Number:

Dealer Name:

Serial Number:

Dealer Address:

Purchase Date:

Dealer Telephone:

2 Table of Contents

Introduction2
 Warranty Registration2
 Please Record Your Model Information2
Table of Contents3
Safety Precautions5
 Safety Alert Definitions5
 General Precautions5
Product Features6
 Échelon Model CLR2160 Clear Ice Maker, Model CLRCO2175 Clear Ice Maker/
 Refrigerator6
Operation7
 Initial Startup7
 Temperature Control7
 Interior Lighting8
 Electronic Control Panel8
 Normal Operating Sounds9
 Outdoor Usage9
 Storage, Vacation, Moving9
 Product Disposal10
Cleaning and Maintenance10
 General Cleaning10
 Maintenance11
Service19
 Before Calling for Service19
 If Service is Required19
 Replacement Parts19
 Troubleshooting Guide20
 Electronic Control Quick Guide22
U-Line Corporation Limited Warranty23

This page intentionally left blank

3 Safety Precautions

IMPORTANT

PLEASE READ all instructions completely before attempting to install, operate, or service your unit.

- Proper installation procedures must be followed if this unit is being initially installed, or is moved to a new location after being in service. An **INSTALLATION GUIDE** for your unit, providing complete installation information is available from U-Line Corporation directly, and must be consulted before any installation is begun. U-Line contact information appears on the rear cover of this guide.
- This unit requires connection to a grounded (three-prong), polarized receptacle that has been placed by a qualified electrician in accordance with applicable electrical codes.

Safety Alert Definitions

Safety items throughout this guide are labeled with a Danger, Warning or Caution based on the risk type:

⚠ DANGER

Danger means that failure to follow this safety statement will result in severe personal injury or death.

⚠ WARNING

Warning means that failure to follow this safety statement could result in serious personal injury or death.

⚠ CAUTION

Caution means that failure to follow this safety statement may result in minor or moderate personal injury, property or equipment damage.

General Precautions

Use this appliance for its intended purpose only and follow these general precautions along with those listed throughout this guide:

⚠ DANGER

RISK OF CHILD ENTRAPMENT. Before you throw away your old refrigerator or freezer, take off the doors and leave shelves in place so that children may not easily climb inside.

⚠ WARNING

SHOCK HAZARD - Electrical Grounding Required.

- Never attempt to repair or perform maintenance on the unit until the electricity has been disconnected.
- Never remove the round grounding prong from the plug and never use a two-prong grounding adapter.
- Altering, cutting of power cord, removal of power cord, removal of power plug, or direct wiring can cause serious injury, fire and/or loss of property and/or life, and will void the warranty.
- Never use an extension cord to connect power to the unit.
- Always keep your working area dry.

⚠ CAUTION

- Use care when moving and handling the unit. Use gloves to prevent personal injury from sharp edges.
- If your model requires defrosting, **DO NOT** use any type of heater to defrost. Using a heater to speed up defrosting can cause personal injury and damage to the inner lining.

IMPORTANT

- Do not lift unit by door handle.
- Never install or operate the unit behind closed doors. Be sure front grille is free of obstruction. Obstructing free air flow can cause the unit to malfunction and may void the warranty.
- Failure to clean the condenser every three months can cause the unit to malfunction. This could void the warranty.
- Allow unit temperature to stabilize for 24 hours before use.
- If your model requires defrosting, never use an ice pick or other sharp instrument to help speed up defrosting. These instruments can puncture the inner lining or damage the cooling unit.
- Use only genuine U-Line replacement parts. Imitation parts can damage the unit, affect its operation or performance and may void the warranty.

4 Product Features

Échelon Model CLR2160 Clear Ice Maker, Model CLRCO2175 Clear Ice Maker/Refrigerator

CLR2160

- This model produces up to 60 lbs (27.2 kg) of ice per day, will store 30 lbs (13.6 kg).
- Stainless steel model is deemed suitable for outdoor use by UL.
- An electronic control panel with digital display allows you to control all operating functions.

CLRCO2175

- This model produces up to 40 lbs (18.1 kg) of ice per day, will store 15 lbs (6.8 kg), and provides 2.5 cu ft (71 L) of refrigeration capacity.
- An electronic control panel with digital display allows you to display the interior refrigerator temperature and adjust the setting to your preference.
- Automatic (cycle) defrost eliminates the need for manual defrosting.
- Three fully encapsulated, contoured shelves contain spills and are easy to clean.
- Recessed shelf channels, supporting the encapsulated shelves, provide a sleek, clean appearance to the interior of the cabinet by eliminating protruding shelf supports.
- Two contoured, inner door “pick-off” shelves are adjustable for storage of a variety of different bottle, can, and container sizes and shapes.
- An interior light will illuminate automatically as the cabinet door is opened. However, you can easily select another mode of operation. A blackout/Sabbath mode (not Star K certified) allows you to darken both interior light and the LED display, while maintaining complete temperature control in the unit.

Exclusive Features of Échelon

- An easy, self-cleaning process for the clear ice maker eliminates complicated procedures.
- Black and white models feature a slightly contoured, across the top, integrated door handle design that permits the door to be easily reversed. The door comes standard with a factory-installed flush panel. These models can accommodate a 1/4 in. (0.64 cm) thick custom panel to achieve a custom, built-in look by matching surrounding cabinets.
- An optional full overlay door panel kit for black and white units, using a customer provided 3/4" (1.9 cm) thick panel, is available that provides a fully integrated appearance with surrounding cabinets. The overlay panel is easily attached to the door.
- Stainless steel model doors are not field-reversible.
- All stainless steel models have a stainless steel full wrap cabinet, door and sculpted handle that distinguishes the Echelon™ stainless steel units from other heavier “commercial” looks.
- Black and white models have vinyl clad steel cabinets that feature a rich textured look, and resist scratching, peeling, or flaking.
- Self-closing door hinges engage when the door is open approximately 8-10 in. (20-25 cm), ensuring a positive door seal and preventing door bounce back.

Features and specifications are subject to change without notice.

5 Operation

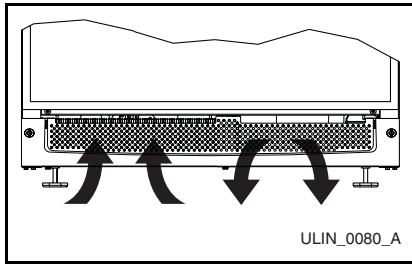

Figure 2

IMPORTANT

Proper air flow (Figure 2) is required for your unit to operate at its highest efficiency. A grille, located in the base of the unit, must not be blocked at any time, or your unit will not perform as expected.

Initial Startup

All U-Line units are shipped with controls that are preset. No initial adjustments are required.

IMPORTANT

- U-Line recommends the unit be allowed to run overnight prior to loading the Model CLRCO2175 refrigerator with product.
- On ice maker equipped units, it is possible that dirt or scale will dislodge in the water line. Always throw away all ice cubes made during the first two to three hours of operation.

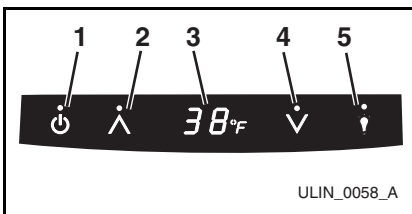

Figure 3

To turn the unit on or off, touch and hold the POWER icon (Figure 3, 1) on the display panel for approximately five seconds until the °F symbol flashes and release.

- A small LED above the icon will illuminate to confirm the touch of any controller icon.
- The CLRCO2175 display (Figure 3, 3) will show the unit set-point temperature (38°F) when the unit is on and will show OFF when the unit is off. The CLR2160 display (Figure 3, 3) will show ICE when the unit is on and will show OFF when the unit is off.
- Turning the unit off will override any other control function.

Temperature Control

Checking Product Temperature

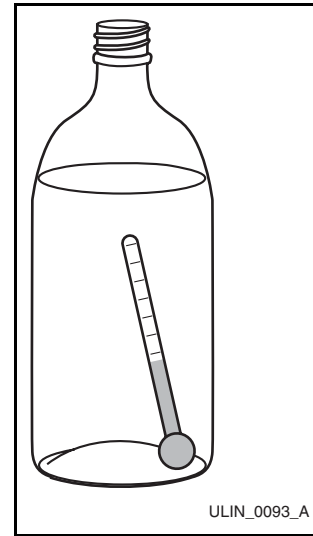

Figure 4

To check the actual product temperature, in refrigerator section only, insert an accurate thermometer into a plastic (non-breakable) bottle that is partially filled with water. Tighten the bottle cap securely (Figure 4).

Place the bottle in the refrigerator area for 24 hours. Refrain from opening the unit during the testing period. After 24 hours, check the temperature of the water. If required, adjust the temperature control in a small increment (See ADJUSTING TEMPERATURE).

Factors which affect the internal temperatures of the cabinet include:

- Temperature setting.
- Ambient temperature where installed.
- Number of times and length of time the door is opened and closed.
- Installation in direct sunlight or near a heat source.

Interior Lighting

The interior of Model CLR2160 is not illuminated. The refrigerator section of Model CLRCO2175 is illuminated whenever the door is opened.

The LIGHT icon (**Figure 3, 5**) on the control panel is used to control an additional Model CLRCO2175 lighting function. The blackout/Sabbath mode (not Star K certified) will turn the interior light and display (**Figure 3, 3**) off.

To access the blackout/Sabbath mode (not Star K certified):

1. Touch and hold the LIGHT icon (**Figure 3, 5**) for ten seconds and release (the °F symbol will flash briefly at the end of the five second period).
2. The interior light and control display (**Figure 3, 3**) will go dark for 36 hours.

NOTE: Although the display will not be visible, the temperature controls in the unit remain active, and the interior temperature will be maintained.

3. To exit the blackout/Sabbath mode (not Star K certified) before the 36-hour period, repeat Step 1.

Electronic Control Panel

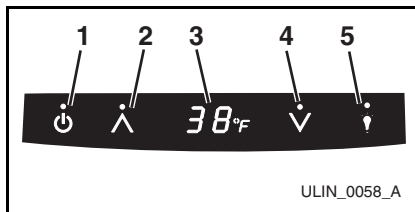

Figure 5

The electronic control with digital display (**Figure 5**) is configured to show a single temperature continuously. This set-point temperature is a base number used by the controller to maintain the temperature zone in your unit. The factory default set-point is 38°F. This set-point temperature is used as a gauge if further temperature adjustments are required.

Temperature Display Selection

U-Line products supplied for 110 VAC operation have temperatures displayed in a default Fahrenheit (°F) configuration (**Figure 5, 3**). Models supplied for 220 VAC operation have temperatures displayed in a default Celsius (°C) configuration.

The display can easily be adjusted for either type of temperature display. Press and hold the LIGHT icon (**Figure 5, 5**) and within five seconds press the COOLER icon (**Figure 5, 4**) three times to change the display as desired.

Temperature Display

To display the Model CLRCO2175 interior temperature:

1. Touch and hold the WARMER icon (**Figure 5, 2**) for approximately five seconds and release when the °F symbol in the display (**Figure 5, 3**) begins to flash.
2. The display (**Figure 5, 3**) will indicate the actual refrigerator temperature.
3. After approximately 10 seconds, the set-point temperature will return to the display.

Factors which affect the internal temperatures of the cabinet include:

- Temperature setting.
- Ambient temperature where installed.
- Number of times and length of time the door is opened and closed.
- Installation in direct sunlight or near a heat source.

Adjusting Temperature

NOTE: The CLRCO2175 refrigerator section temperature is adjustable. The storage bin temperatures in Model CLRCO2175 and CLR2160 are not adjustable.

IMPORTANT

Adjust the set-point temperature in single increments, and wait 24 hours for the temperature to stabilize before rechecking.

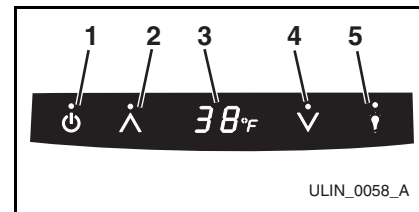

Figure 6

To adjust the set-point temperature:

1. Press and release either the WARMER (**Figure 6, 2**) or COOLER (**Figure 6, 4**) icon to put the controller in the SET TEMPERATURE mode. The °F symbol (**Figure 6, 3**) will begin to flash.

NOTE: If no further action is taken, this mode will self cancel in five seconds, and the original set-point temperature will be displayed.

2. While the °F symbol is flashing, press the WARMER or COOLER icon as required to adjust the set-point temperature.
3. The change will be set five seconds after adjusting the temperature, and the new set-point temperature will be displayed.

Normal Operating Sounds

All models incorporate rigid foam insulated cabinets to provide high thermal efficiency and maximum sound reduction for its internal working components. In spite of this technology, your model may make sounds that are unfamiliar.

Normal operating sounds may be more noticeable because of the unit's environment. Hard surfaces such as cabinets, wood/vinyl/tiled floors and paneled walls have a tendency to reflect normal appliance operating noises.

Common refrigeration components, and a brief description of the normal operating sounds they make, are listed below. **NOTE:** Your product may not contain all of the components listed.

- Compressor: The compressor makes a hum or pulsing sound that may be heard when it operates.
- Evaporator: Refrigerant flowing through an evaporator may sound like boiling liquid.
- Condenser Fan: Air moving through a condenser may be heard.
- Automatic Defrost/Drain Pan: Water may be heard dripping or running into the drain pan when the unit is in the defrost cycle.
- Automatic Ice Maker: You will hear ice as it drops from the mold into the ice bin/tray.
- Water Valve: The water valve will make an occasional buzzing sound and running water will be heard.

Outdoor Usage

Some U-Line models are designed to operate in outdoor environments. For best performance, keep the unit out of direct sunlight.

- If the unit will be shut off for five days or more, prop door open to allow for air circulation and prevent mold and mildew.

IMPORTANT

If the ambient temperature is expected to drop below 45°F, turn off and unplug unit, and drain all water from the unit to prevent freezing damage not covered by the warranty.

- High ambient temperatures (110°F or higher) may reduce the unit's ability to reach low temperatures.

Storage, Vacation, Moving

If the unit will not be used for an extended period, or otherwise stored, follow these steps completely:

WARNING

Electrical Shock Hazard. Disconnect power before servicing. Before operating, replace all panels. Failure to do so may result in death or electrical shock.

1. Remove all consumable contents from the unit.
2. Disconnect power to the unit.
3. Shut off water supply to the unit at the main water source.

IMPORTANT

- **If the ambient temperature is expected to drop below 45°F, turn off and unplug unit, and drain all water from the unit to prevent freezing damage not covered by the warranty.**
 - **The use of anti-freeze or other products of this nature is not necessary and is not recommended.**
4. Disconnect the water valve inlet and outlet lines, and allow them to drain completely.
 5. Reconnect power to the unit, and allow it to run for one hour (minimum) until any remaining ice has been ejected from the ice maker assembly.
 6. Disconnect power to the unit, dry any remaining water from the ice maker assembly, and reconnect any lines removed from the water supply valve.
 7. Disconnect the power cord from its outlet, and leave it disconnected until the unit is returned to service.
 8. Clean and dry the interior of the cabinet (See CLEANING AND MAINTENANCE: GENERAL CLEANING).
 9. During periods of non-use, the cabinet must remain open to prevent the formation of mold and mildew. Open door a minimum of 2" (5 cm) to provide the necessary ventilation.

Product Disposal

If the unit is being removed from service for disposal, check and obey all Federal, State and/or Local regulations regarding the disposal and recycling of refrigeration appliances, and follow these steps completely:

1. Disconnect power to the unit and unplug the power cord from its outlet.
2. Shut off water supply to the unit at the main water source and disconnect the supply line to the unit's water valve.

 **DANGER**

RISK OF CHILD ENTRAPMENT. Before you throw away your old refrigerator or freezer, take off the doors and leave shelves in place so that children may not easily climb inside.

3. Remove the cabinet door if equipped and secure all interior shelves to the interior of the cabinet using a heavy duty cloth or package sealing tape.

6 Cleaning and Maintenance

General Cleaning

Exterior Cleaning (As Required)

Black and White Models:

- Surfaces may be cleaned with a mild detergent and warm water solution. Do not use solvent-based or abrasive cleaners. Use a soft sponge and rinse with clean water. Wipe with a soft, clean towel to prevent water spotting.

Stainless Steel Models:

- Stainless steel surfaces and components can discolor when exposed to chlorine gas, pool chemicals, salt water or cleaners with bleach.
- Keep your stainless steel unit looking new by cleaning with a good quality all-in-one stainless steel cleaner/polish on a monthly basis. For best results use Claire® Stainless Steel Polish and Cleaner, which can be purchased from U-Line Corporation (P/N 173348). Comparable products are acceptable. Frequent cleaning will remove surface contamination that could lead to rust. Some installations may require cleaning on a weekly basis.
- **Do not clean with steel wool pads.**
- **Do not use cleaners that are not specifically intended for stainless steel on stainless steel surfaces (this includes glass, tile and counter cleaners).**
- If any surface discoloring or rusting appears, clean it quickly with Bon-Ami® or Barkeepers Friend Cleanser® and a non-abrasive cloth. Always clean in the direction of the grain. Always finish this process with Claire Stainless Steel Polish and Cleaner or comparable product to prevent further problems.
- **Using abrasive pads such as Scotchbrite™ will cause the graining in the stainless steel to become blurred.**
- Rust that is not cleaned up promptly can penetrate into the surface of the stainless steel and complete removal of the rust may not be possible.

Interior Cleaning (As Required)

- Disconnect power to the unit. Clean the interior and all removed components using a mild non-abrasive detergent and warm water solution applied with a soft sponge or non-abrasive cloth. Rinse the interior using a soft sponge and clean water.
- **Do not use any solvent-based or abrasive cleaners. These types of cleaners may transmit taste to the interior products and damage or discolor the interior.**

Maintenance

Proper maintenance of your U-Line product will ensure efficiency, top performance and long life. The maintenance intervals listed are based on normal conditions. You may want to shorten the intervals if you have pets or other special considerations.

Defrosting

Automatic (Cycle) Defrost and Frost-Free Models

These models do not produce frost in normal operating conditions. However, a frost pattern may be noticed on the interior walls if the unit is repeatedly opened in a high heat or high humidity location. If this frost pattern does not clear within 24 hours, your unit will require manual defrosting.

⚠ WARNING

DO NOT use any type of electrical heating device, ice pick, knife or other sharp instrument to defrost; this could damage the inner lining or refrigeration system and void the warranty.

IMPORTANT

The drain pan was not designed to capture the water created when manually defrosting. To prevent water from overflowing the drain pan, place towels or other absorbent materials over the interior drain trough, under the evaporator (Figure 7, 1), before defrosting.

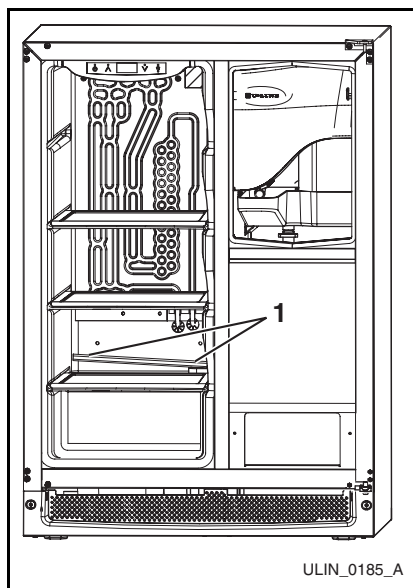

Figure 7

To defrost:

1. Turn unit off.
2. Remove all products from the interior and prop the door in an open position (2 in. (5 cm) minimum).
3. Allow the frost to completely melt naturally. Clean the interior and all removed components using a mild non-abrasive detergent and warm water solution applied with a soft sponge or non-abrasive cloth. **NOTE: DO NOT use any solvent-based or abrasive cleaners. They will discolor or damage the interior.**
4. Dampen a soft sponge or non-abrasive cloth in clean water and wipe down the cabinet interior and removed components to remove any detergent residue. Rinse the sponge or cloth in clean water and repeat as necessary until the cabinet and components are clean.
5. When the interior is dry, turn unit back on.

Condenser Cleaning

Interval - Every Three Months

To maintain operational efficiency, keep the front grille free of dust and lint and clean the condenser every three months. Depending on environmental conditions, more or less frequent cleaning may be necessary.

⚠ WARNING

Disconnect electric power to the unit before cleaning the condenser.

To remove and replace the grille for access to the condenser fins, follow this procedure:

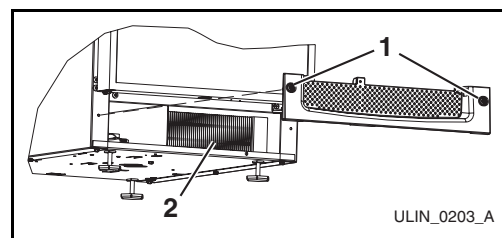

Figure 8

1. Disconnect electrical power to the unit.
2. Loosen two screws (**Figure 8, 1**) completely.
NOTE: Screws are held in the grille by o-ring retainers, and will not come free of the grille.
3. Remove the grille.

⚠ WARNING

DO NOT touch the condenser fins. The condenser fins are SHARP and can be easily damaged.

⚠ CAUTION

DO NOT use any type of cleaner on the condenser unit.

4. Clean the condenser coil (**Figure 8, 2**) using a soft brush with a “combing” action or vacuum cleaner. Do not touch the condenser coil.
5. Position the grille to align the mounting screws with the holes in the cabinet.
6. Secure, but do not over-tighten both grille screws.
7. Reconnect power to the unit.

Clear Ice Maker Maintenance

Self-Cleaning Cycle

Interval - Every Six Months

To maintain operational efficiency, clean the unit every six months (depending on water conditions, more or less frequent cleaning may be necessary). If the ice maker requires more frequent cleaning, consult a qualified plumber to test the water quality and recommend appropriate treatment.

⚠ WARNING

Wear rubber gloves and safety goggles and/or face shield when handling Ice Machine Cleaner.

⚠ CAUTION

Use only U-Line Ice Machine Cleaner (P/N 41978, available from your dealer or direct from U-Line). It is a violation of federal law to use this solution in a manner inconsistent with its labeling. Use of any other cleaner can ruin the finish of the evaporator and will void the warranty. Read and understand all labels printed on the package before use.

U-Line Ice Machine Cleaner is used to remove lime scale and other mineral deposits. Refer to the following steps to initiate the self-cleaning cycle.

IMPORTANT

- **The Model CLRCO2175 refrigerator will not operate during the ice maker cleaning cycle. Remove all fresh food to prevent spoilage.**
- **Model CLRCO2175 ice production after the first harvest may take longer after the cleaning cycle since restoring the refrigerator temperature will take precedence over ice production. Once the refrigerator reaches its set-point temperature, ice making will resume.**

IMPORTANT

Never use anything to force ice from the evaporator. Damage may result.

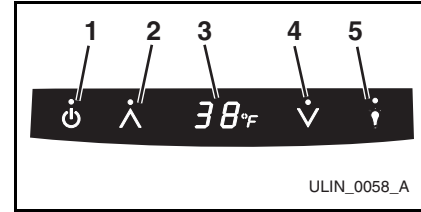

Figure 9

1. Turn the ice maker off (allowing any ice to melt off of the evaporator) as follows:
 - a. Touch and hold the ON/OFF button (**Figure 9, 1**).
 - b. The display (**Figure 9, 3**) will switch from ICE to OFF to confirm that the ice maker is off.
2. Remove all ice from the storage bin.

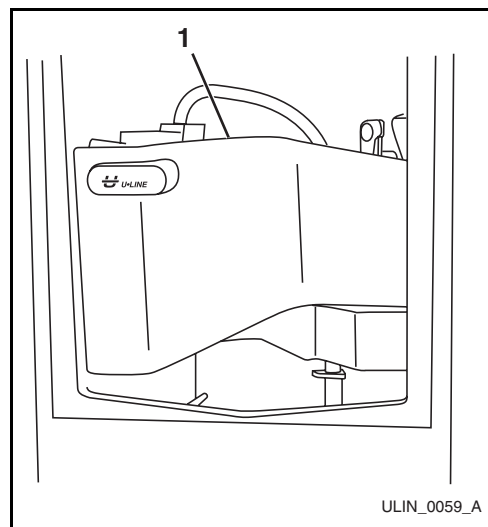

Figure 10

3. Remove inside front cover (**Figure 10, 1**).

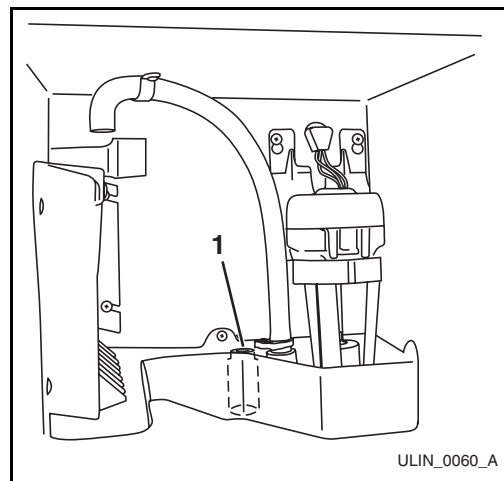

Figure 11

4. Remove the overflow tube (**Figure 11, 1**) by lifting it up while using a slight back and forth motion to loosen

it from the drain hole. The water in the reservoir will flow down the drain.

5. Replace the overflow tube after all of the water has drained from the reservoir.
6. Start the cleaning cycle as follows:
 - a. Touch and hold the ON/OFF button (**Figure 9, 1**).
 - b. Touch and release the LIGHT button (**Figure 9, 4**) three times, then release the ON/OFF button (**Figure 9, 1**).
 - c. The display (**Figure 9, 3**) will show "CL" to confirm the beginning of the cleaning cycle.
7. When water begins to flow over the evaporator (approximately three minutes), add one package of U-Line Ice Machine cleaner to the water reservoir.
8. Reinstall inside front cover.
9. When the self-cleaning process stops (approximately 45 minutes) the unit will remain off for an additional 15 minutes. When clean cycle is completed, display will automatically switch back to set temperature and unit will run as normal operation.
10. Clean the storage bin (See INTERIOR CLEANING). Sanitize the bin with a solution of 1 tablespoon of bleach in 1 gallon of warm water. Rinse thoroughly with clean water.
11. To ensure that the drain system is working properly, pour 1 gallon of cool, fresh water into the ice bin. The water should drain freely. If your unit is equipped with a drain pump, it should drain the ice bin.

When ice production resumes, the water fill valve will energize, fill the water reservoir, and shut-off after three minutes. The compressor begins to operate and water flows over the evaporator assembly (ice cube tray). Initially, the water flow may not be uniform, causing uneven sized cubes or water to spill into the ice storage bin. This is a normal situation that will correct itself within the first 24 hours of operation.

IMPORTANT

- **Discard all ice produced in the first harvest.**
- **Should power to the unit be interrupted during the self-clean cycle, it will be necessary to repeat the complete cleaning cycle after power is restored.**

Inlet Screen

Interval - Every Twelve Months

The solenoid valve inlet screen must be cleaned at least once each year as follows:

1. Shut off the water at the main supply valve.
2. Pull the unit out to access the back panel.
3. Disconnect electrical power to the unit.

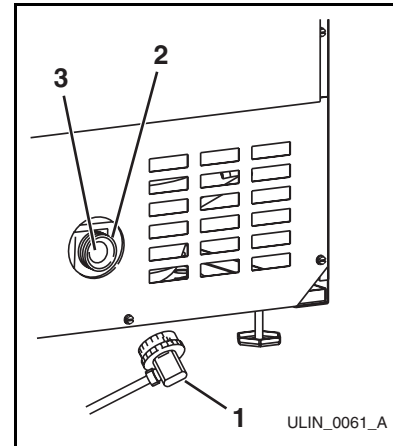

Figure 12

4. Disconnect the hose connector (**Figure 12, 1**) from the water solenoid valve (**Figure 12, 2**).
5. **DO NOT** remove the inlet screen (**Figure 12, 3**) from the water solenoid valve. Use a toothbrush to gently clean any sediment from the inlet screen.
6. Re-connect the water supply hose connector (**Figure 12, 1**) to the water solenoid valve (**Figure 12, 2**). Tighten the connector securely.
7. Open the water main supply valve and check for leaks at the water hose connection. Ensure that the water supply line is not kinked.
8. Reconnect power to the unit before re-installing.
9. Make sure the drain system is working properly and the drain hose is not pinched or kinked. Pour 1 gallon of cool, fresh water into the ice bin. The water should drain freely. If your unit is equipped with a drain pump, the pump should drain the ice bin.
10. To ensure that the drain system is working properly, pour 1 gallon of cool, fresh water into the ice bin. The water should drain freely. If your unit is equipped with a drain pump, it should drain the ice bin.

Ice Cube Thickness Adjustment

Interval - As Required

Ice thickness adjustments are made using the control panel as follows:

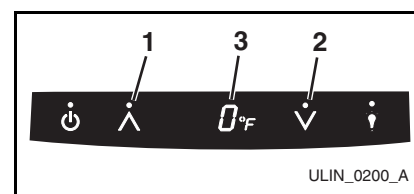

Figure 13

1. To enter the thickness adjustment mode:
 - a. Touch and hold the UP ARROW button (**Figure 13, 1**).

- b. Touch and release the DOWN ARROW (**Figure 13, 2**) button three times, then release the UP ARROW button (**Figure 13, 1**).
 - c. The display (**Figure 13, 3**) will switch to "0" to confirm the thickness adjustment mode has been selected.
2. The factory setting is "0," and the total range of adjustment is -5 to +5. Use the UP ARROW button to raise the setting and thicken the ice bridge, or the DOWN ARROW button to lower the setting to thin the ice bridge.

IMPORTANT

Ice thickness adjustment should only be made one increment at a time. Allow ice maker production to stabilize for 24 hours before rechecking ice thickness.

3. Touch and release the LIGHT (**Figure 13, 4**) button key to exit the ice thickness adjustment mode.
4. Remove all ice from the storage bin.

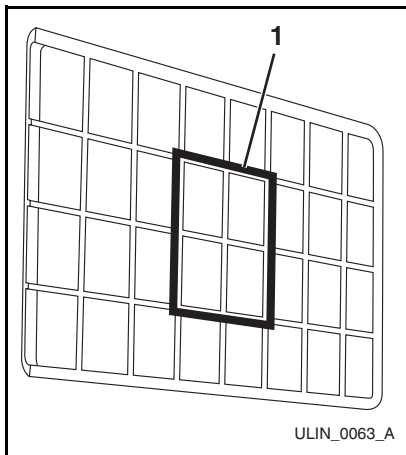

Figure 14

5. Ice cubes in any given batch will vary, so it is necessary to choose cubes from the sample area (**Figure 14, 1**) for comparison when making adjustments. If further adjustments are desired, repeat Steps 1 through 4.

Drain Pump

Interval - Not Required

A drain pump, if installed, requires no routine maintenance. To check its operation, pour 1 gallon of cool, fresh water into the ice bin. The drain pump will run and water should drain freely from the bin.

Leveling

IMPORTANT

It is extremely important that Clear Ice models are level. If not level, the ice mold will not fill evenly.

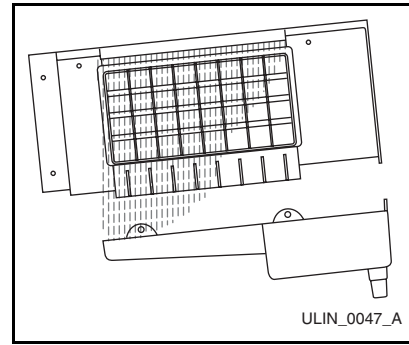

Figure 15

A unit that is not level can cause a reduction in ice rate, uneven sized cubes or water spilling into the storage area, which will cause the ice in the bin to melt prematurely (**Figure 15**).

When checking the level, remember that floors near drains have a tendency to slope towards the drain.

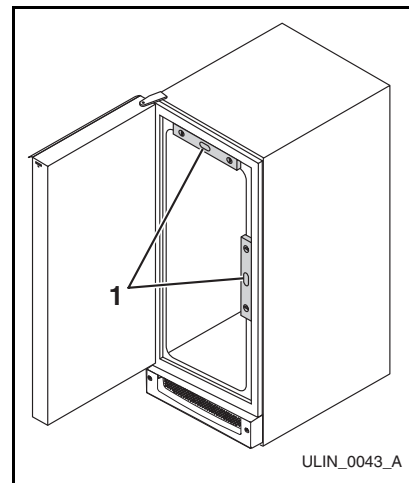

Figure 16

Use a level to check the levelness of the unit from front to back and from side to side. Level should be placed along top edge and side edge as shown (**Figure 16**).

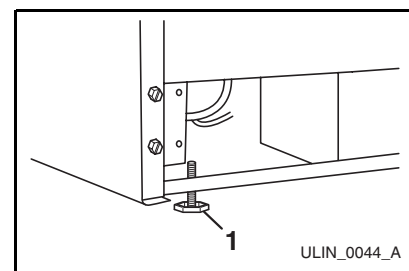

Figure 17

6. If the unit is not level, adjust the feet on the corners of the unit as necessary (**Figure 17**).
7. Check the levelness after each adjustment and repeat the previous steps until the unit is level.

Door Alignment Check and Adjustment

IMPORTANT

When properly aligned:

- The door will not be flush with the top of the cabinet. The top edge of the door will be 1/8 in. (3.175 mm) below the cabinet top.
- The door gasket will be firmly in contact with the perimeter of the cabinet and not pinched on the hinge side of the door.

The following procedure will correct for up to 1/4 in. misalignment:

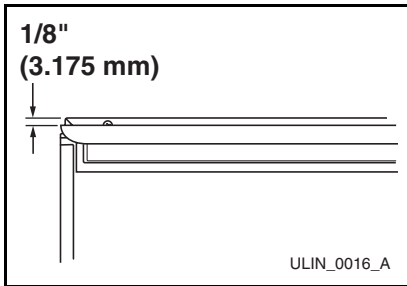

Figure 18

1. Compare the top edge of the door (opposite the hinges) to the top edge of the cabinet (**Figure 18**) and note the type (up or down) of adjustment needed.

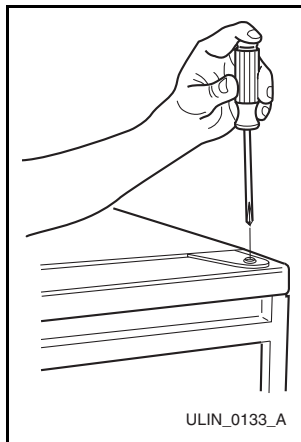

Figure 19

2. Remove the top hinge pivot pin with a Phillips screwdriver (**Figure 19**) and lift door off bottom hinge pin. Be careful not to lose the door closer insert sets.

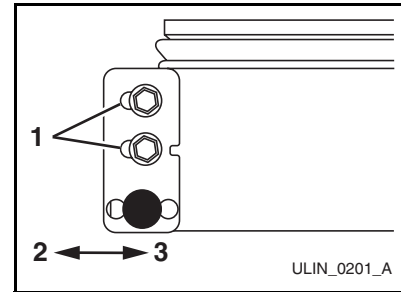

Figure 20

3. Turn the door upside down and inspect the hinge plate mounting holes.
 - Your plate has slotted mounting holes (**Figure 20, 1**). Loosen but do not remove the two hinge plate screws.
4. If door edge opposite the hinges needs to move up, move plate toward outside of door (**Figure 20, 2**). If door edge needs to move down, move plate toward inside of door (**Figure 20, 3**). Repeat until top edge of door is parallel with top of cabinet and tighten screws securely (**Figure 20, 1**).

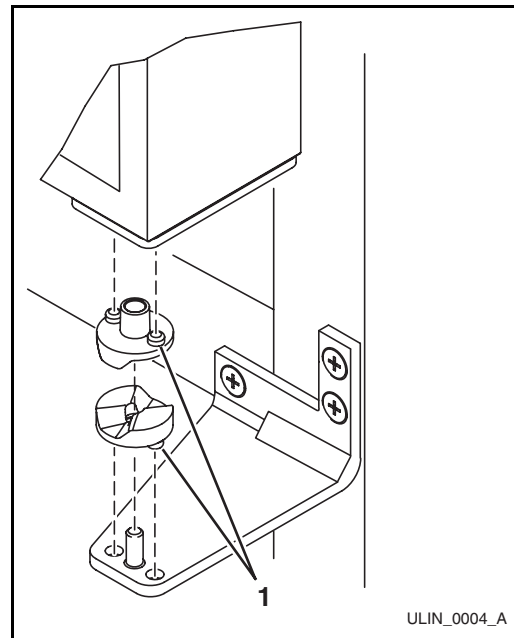

Figure 21

5. After adjustment is complete, remove the door closers from the bottom hinge, clean thoroughly and apply petroleum jelly to the mating surfaces of the closers. Be sure that bosses on closers (**Figure 21, 1**) align with holes in the door and bottom cabinet hinge plates. Mount door and install top hinge pivot pin.

Door Reversal

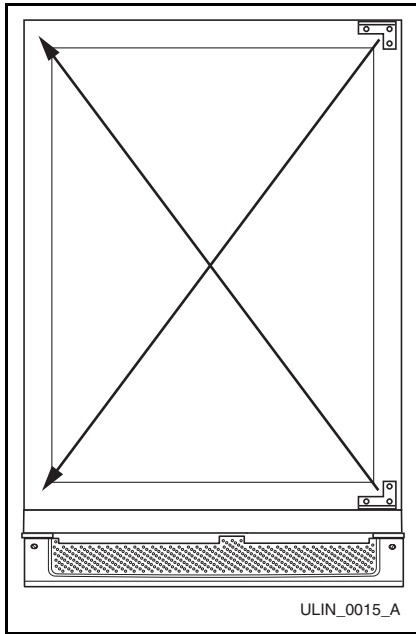

Figure 22

Black and white units may be left- or right-hand opening. Stainless steel unit doors cannot be reversed. The doors are easily reversed by moving the hinge hardware to the opposite side. The top hinge hardware will be used on the bottom of the other side and the bottom hinge hardware will be used on the top of the other side (**Figure 22**).

To reverse the door:

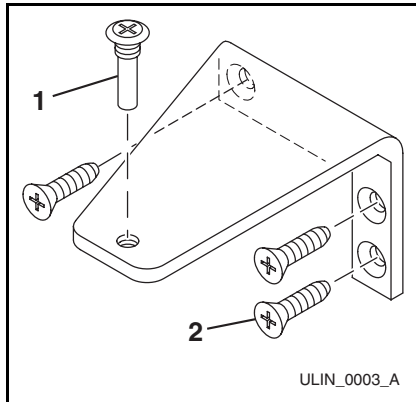

Figure 23

1. Remove top hinge screw pin (**Figure 23, 1**) from door using a Phillips screwdriver. Remove door by tilting forward and lifting off bottom hinge pin.

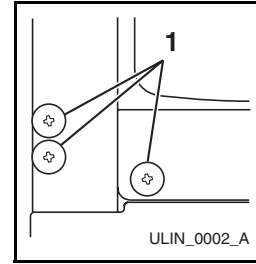

Figure 24

2. Remove plastic screw plugs (three each, top and bottom) (**Figure 24, 1**) from new hinge location. Do not discard.
3. Remove top hinge (three screws) (**Figure 23, 2**) and reinstall hinge screw pin (**Figure 23, 1**).

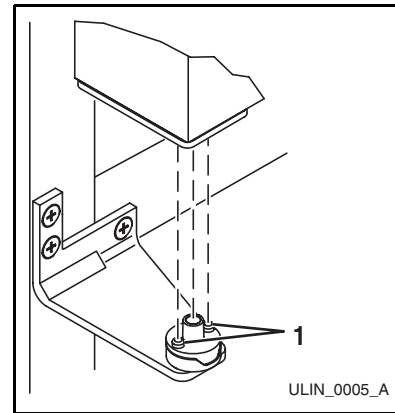

Figure 25

4. Install the removed top hinge mount on opposite side **BOTTOM** (**Figure 25**).

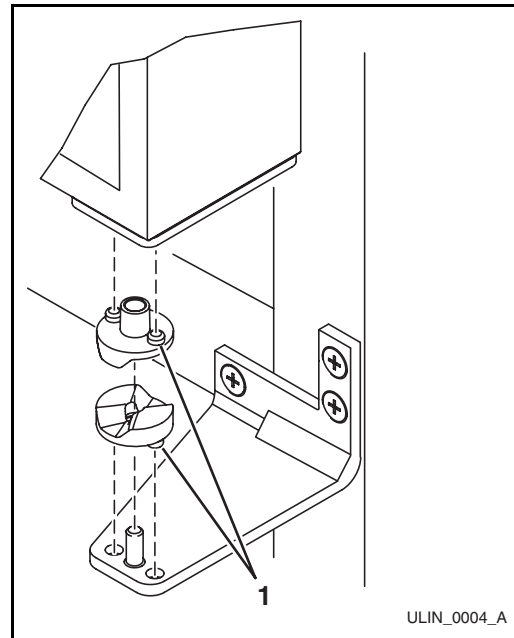

Figure 26

5. Remove the two door closer inserts (**Figure 26, 1**) from the existing bottom hinge and install as shown on the new bottom hinge (**Figure 25, 1**).
6. Remove existing bottom hinge (three screws) and remount on opposite side TOP. Remove hinge screw pin.
7. Remove the plastic hole plug from the top of the door to allow the pivot pin to be inserted in the new location. Install the plug into the vacated hole on the opposite side.

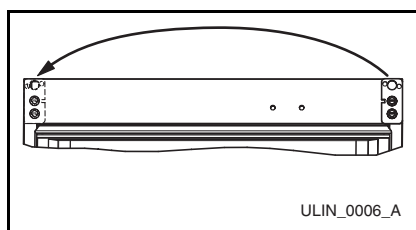

Figure 27

8. With bottom of door facing up, remove pivot plate (two screws), flip over, and remount on opposite side of door (**Figure 27**). **Be sure notch in plate faces center.**
9. Holding door upright with top of door tilted forward, place hole of door pivot plate on bottom hinge screw pin/closer inserts (**Figure 25, 1**).
10. Tilt top of door into position in top hinge and install top hinge screw pin.
11. Install plastic screw plugs removed in Step 2 in old hinge holes (three each, top and bottom).

Door Shelf Removal/Insertion

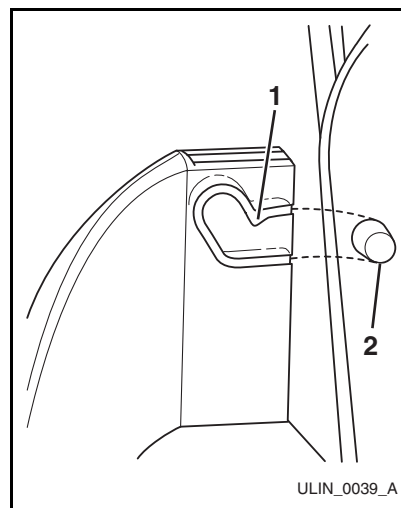

Figure 28

To remove the door shelf:

1. Grasp shelf in center, lift slightly, and tilt 15°-20°.
2. Carefully pull shelf off bosses (**Figure 28, 2**).

To install the door shelf:

1. Holding shelf in center, align notches (**Figure 28, 1**) in shelf with bosses (**Figure 28, 2**) in door.
2. Tilt shelf at a 15°-20° angle and slide onto bosses at the desired location.

Glass Shelf Removal/Installation

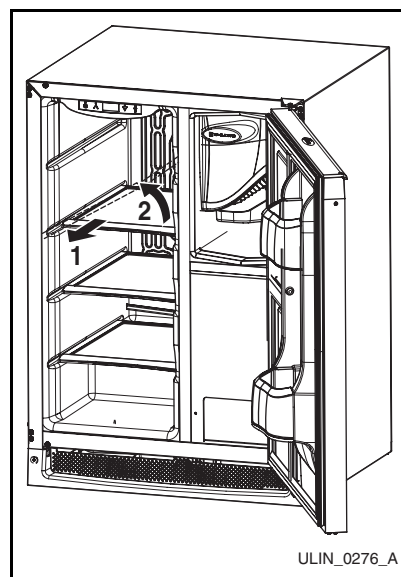

Figure 29

1. Pull shelf out about 6" (**Figure 29, 1**) until back of shelf clears the "hump" on the right-hand side.
2. Tilt right-hand edge of shelf up.
3. Remove shelf from unit by pulling out (**Figure 29, 2**).

Insert the shelves as follows:

1. To move to a different position in the unit, insert shelf at an angle, approximately 15-20°, over the rib in the side of the unit where you want to place the shelf. The shelf must be started into the unit at an angle to clear the door.
2. Continue to slide the shelf into the unit at an angle until it clears the door.
3. Lower the shelf and push it in completely.

Light Bulb Replacement

CLRC02175

To replace the light bulb in your U-Line unit:

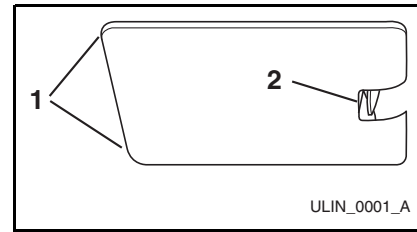

Figure 30

1. Grasp the edges of the light housing lens (**Figure 30, 1**) opposite the exposed tab, and gently push the lens towards the tab (**Figure 30, 2**).
2. Pull the edge of the lens down (**Figure 30, 1**), and swing it out of the light housing.

IMPORTANT

ALWAYS use a genuine U-Line replacement bulb (P/N 31317) in the light housing. Use of any other bulb within the housing will generate excessive heat, causing damage to the light housing and cabinet interior, and compromising the precise temperature control of your unit.

3. Replace the bulb only with a genuine U-Line P/N 31317 replacement.
4. Replace the lens by first inserting the tab side back into the housing at a slight angle. While gently pushing the lens towards the tab end, push the free end up into the housing, and release when you will hear a snap/click.

7 Service

Before Calling for Service

If your U-Line product appears to be malfunctioning, read through the OPERATION section of this guide to ensure that the function of all controls are clearly understood. If the malfunction persists, the TROUBLESHOOTING GUIDE in this guide will assist you in quickly identifying common problems, and provide information on possible causes and remedies. Most often, this will resolve the problem without the need to call for service.

If Service is Required

If you do not understand a troubleshooting remedy, or your product needs service, contact U-Line Corporation directly. Contact information appears on the rear cover of this guide.

You will be asked for your product Model and Serial Numbers. This information should be recorded inside the front cover of this guide, following the products original purchase. It also appears on the Model and Serial number plate located on the upper right or rear wall of the interior of your product.

Replacement Parts

When you need replacement parts, always request that genuine U-Line replacements be used. U-Line products have been designed and engineered using components that work efficiently, and provide superior service life and performance. The use of aftermarket parts or components may affect the safety, operation, performance or durability of your product, and may also void its warranty.

Troubleshooting Guide



NOTE: Recommended refrigerator temperature setting is 38°F.

ELECTROCUTION HAZARD

Never attempt to repair or perform maintenance on the unit until the main electrical power has been disconnected.

















Troubleshooting - What to check when problems occur:

PROBLEM	POSSIBLE CAUSE	REMEDY
Unit does not operate and electronic display is blank.	No electrical supply	Plug unit in or check circuit breaker.
	Low air temperature around unit	Surrounding air temperature must be at least 50°F.
No interior light (Model CLRCO2175)	No power to unit	Make sure power cord is plugged in.
	Loose or burned out bulb	Tighten or replace bulb (See MAINTENANCE; LIGHT BULB REPLACEMENT).
Electronic display is blank and interior light is ON with door OPEN (Model CLRCO2175).	A display function has changed.	Touch and hold the warmer temperature button and touch and release the POWER button three times, then release the temperature button. The display should become visible.
Electronic display is blank with door OPEN (Model CLR2160).	A display function has changed.	Touch and hold the warmer temperature button and touch and release the POWER button three times, then release the temperature button. The display should become visible.
Electronic display shows repeating, randomly flashing symbols and partial characters.	A factory control mode has been inadvertently entered.	Touch and hold the warmer temperature button and touch and release the LIGHT button three times, then release the temperature button to exit the factory control mode. The set-point temperature should now be displayed.
Electronic display shows: 0, 1 to 26, or 99.	A factory control mode has been inadvertently entered.	Repeatedly touch the warmer temperature button to advance any number shown to 99 and touch and release the LIGHT button. The set-point temperature should now be displayed.
Electronic display shows E3.	Door has been left open longer than 20 minutes.	Close door completely. The set-point temperature should now be displayed.
Electronic display shows one or more of the following: E1, E2, E4, E5, E6, E7, E8, E9, E10, P1.	The unit is displaying an error code.	Record the error code(s) displayed and call for service.
The unit is not cold enough.	Dirty condenser coils	Clean condenser (See MAINTENANCE; CONDENSER CLEANING).
	Airflow to front grille blocked	Airflow must not be obstructed to front grille (See OPERATION).
	Temperature not set cold enough (Model CLRCO2175)	Use the temperature controller to set temperature colder. Allow 24 hours for temperature to stabilize.
	Door is not closing completely.	Make sure no obstructions are blocking the door and unit is level (See MAINTENANCE; LEVELING).
		Door adjustment required (See MAINTENANCE; DOOR ALIGNMENT CHECK AND ADJUSTMENT).
Door gasket not sealing properly	Adjust door (See MAINTENANCE; DOOR ALIGNMENT CHECK AND ADJUSTMENT and DOOR REVERSAL).	
Noise during operation	Certain sounds are normal.	Soft sounds from the fan, water running in the ice maker and the sound of ice dropping will be heard.
Fresh food section too cold (Model CLRCO2175)	Temperature control set too cold	Use the temperature controller to set temperature warmer.
Unit runs but no ice is produced.	No water being supplied to the unit	Check to see that water is connected and turned on to the unit.







PROBLEM	POSSIBLE CAUSE	REMEDY
Unit runs but produces very little ice.	Dirty condenser coils	Clean the condenser (See MAINTENANCE; CONDENSER CLEANING).
	High air temperature around unit	Surrounding air temperature of over 90°F. Low ice production at high temperatures is normal.
	Scale and mineral buildup in unit	Run unit through self cleaning cycle (See MAINTENANCE; ICE MAKER: SELF CLEANING CYCLE).
	Inadequate airflow at the front of the unit	Remove items blocking airflow.
	Cleaning Cycle recently performed	Allow unit to reach the set temperature to produce ice normally.
Poor ice quality (soft or unclear)	Unit is not level.	Level unit (See MAINTENANCE; LEVELING).
	Poor incoming water quality	Consult a qualified plumber to test the water quality and recommend appropriate treatment.
	Ice-making system is dirty.	Run unit through self cleaning cycle (See MAINTENANCE; ICE MAKER: SELF CLEANING CYCLE).
Unit produces shallow or incomplete cubes, or the ice fill pattern on the evaporator is incomplete.	Low water level	Check to see that overflow tube is fully seated.
	Hot incoming water	Connect the unit to a cold water supply.
	Incorrect incoming water pressure	Water pressure must be 20-120 psi.
	Unit is not level.	Level unit (See MAINTENANCE; LEVELING).
Ice is slow to release or does not release from the evaporator.	Ice-making system is dirty.	Run unit through self cleaning cycle (See MAINTENANCE; ICE MAKER: SELF CLEANING CYCLE).
	Unit is not level.	Level the unit (See MAINTENANCE: LEVELING).
	Low air temperature around unit	Surrounding air temperature must be at least 50°F.
Ice storage bin full of water	Obstructed drain	Check to see that storage bin drain opening is free from obstruction and debris.
Water leaking from under the unit	Supply line leaking	Tighten connection as required.
	Fill tube leaking	Check connection at water valve outlet.
	Bin drain leaking	Check integrity of bin drain hose and clamp.

Electronic Control Quick Guide







All Models

Task	Touch	Touch	Display	Comment
Turn ON/OFF	 Hold 10 seconds	Release when °F flashes.	 or 	
Adjust Temperature	 or  Touch and release	 or  Touch to change temperature		°F flashes after first touch, set-point saved after 5 seconds of inactivity and °F stops flashing.
View Actual Temperature (T1)	 Hold 5 seconds	Release when °F flashes.		(For Wine Cooler Only) Will scroll top/middle/bottom temperatures.
Change °F-°C	 Hold	  	 or 	Repeat to switch back.
Blackout Mode	 Hold 10 seconds		Display (and cabinet light) not operable in Blackout Mode.	Blackout will end in 36 hours.















Glass Door Models

Task	Touch	Touch	Display	Comment
Cabinet Light				Light normally goes on/off with door opening. Pressing light button will turn interior light on for 4 hours, then it will turn off.
Display Off Mode	 Hold	  		Display off when door is closed (unless cabinet light is switched on). Repeat to switch back.

All Ice Makers

Task	Touch	Touch	Display	Comment
Ice Maker Off Mode	 Hold	  	 	Repeat to switch back

Clear Ice & Clear Combo Only

Task	Touch	Touch	Display	Comment
Clean Cycle	 Hold	  		Will automatically return to ice production when clean cycle is complete.
Ice Thickness Adjustment	 Hold	  		Use warmer/colder to scroll.
Temporary Shutdown (Office Mode)	 Hold	  		Ice maker will automatically turn back on in three hours.

NOTE: 38°F is an example; the display will vary with actual set-point.

IMPORTANT

Factory recommended set-point is 38°F for refrigerators and beverage centers, and 50°F for wine coolers.

U-Line Corporation Limited Warranty

U-Line Corporation warrants each U-Line product to be free from defects in materials and workmanship for a period of one year from the date of purchase; and warrants the sealed system (consisting of the compressor, the condenser, the evaporator, the hot gas bypass valve, the dryer and the connecting tubing) in each U-Line product to be free from defects in materials and workmanship for a period of five years from the date of purchase. During the initial one-year warranty period for all U-Line products U-Line shall: (1) at U-Lines option, repair any product or replace any part of a product that breaches this warranty; and (2) for all Marine, RV and Domestic U-Line products sold and serviced in the United States (including Alaska and Hawaii) and Canada, U-Line shall cover the labor costs incurred in connection with the replacement of any defective part. During years two through five of the warranty period for the sealed system, U-Line shall: (1) repair or replace any part of the sealed system that breaches this warranty; and (2) for all Marine, RV and Domestic U-Line products sold and serviced in the United States (including Alaska and Hawaii) and Canada, U-Line shall cover the labor costs incurred in connection with the replacement of any defective part of the sealed system. All other charges, including transportation charges for replacements under this warranty and labor costs not specifically covered by this warranty, shall be borne by you. This warranty is extended only to the original purchaser of the U-Line product. The Registration Card included with the product should be promptly completed by you and mailed back to U-Line or you can register on-line at www.U-LineService.com.

The following are excluded from this limited warranty: installation charges; damages caused by disasters or acts of God, such as fire, floods, wind and lightening; damages incurred or resulting from shipping, improper installation, unauthorized modification, or misuse/abuse of the product; customer education calls; food loss/spoilage; door and water level adjustments (except during the first 90 days from the date of purchase); defrosting the product; adjusting the controls; door reversal; or cleaning the condenser.

If a product defect is discovered during the applicable warranty period, you must promptly notify either the dealer from whom you purchased the product or U-Line at P.O. Box 245040, Milwaukee, Wisconsin 53224 or at 414-354-0300. In no event shall such notification be received later than 30 days after the expiration of the applicable warranty period. U-Line may require that defective parts be returned, at your expense, to U-Lines factory in Milwaukee, Wisconsin, for inspection. Any action by you for breach of warranty must be commenced within one year after the expiration of the applicable warranty period.

This limited warranty is in lieu of any other warranty, express or implied, including, but not limited to any implied warranty of merchantability or fitness for a particular purpose; provided however, that to the extent required by law, implied warranties are included but do not extend beyond the duration of the express warranty first set forth above. U-Lines sole liability and your exclusive remedy under this warranty is set forth in the initial paragraph above. U-Line shall have no liability whatsoever for any incidental, consequential or special damages arising from the sale, use or installation of the product or from any other cause whatsoever, whether based on warranty (express or implied) or otherwise based on contract, tort or any other theory of liability.

Some states do not allow limitations on how long an implied warranty lasts or the exclusion or limitation of incidental or consequential damages, so the above limitations may not apply to you. This warranty gives you specific legal rights, and you may also have other rights which vary from state to state.



For General Inquiries:

P.O. Box 245040
Milwaukee, Wisconsin
53224-9540 U.S.A.
Phone (800) 779-2547
FAX (414) 354-5696
www.U-Line.com

For Service and Parts Assistance:

Phone (800) 779-2547
(414) 354-0300
FAX (414) 354-5696
Email:
OnLineService@U-Line.com
www.U-LineService.com
E-mail:
OnlineParts@u-line.com

Échelon Series

For more than four decades, U-Line has distinguished itself as the leader in built-in under-counter ice making, refrigeration and wine storage appliances.

An INSTALLATION MANUAL for your unit, providing complete installation information, is available for download at www.U-Line.com. Information for custom panel inserts per model, including panel size, and instructions are available by visiting www.U-Line.com.

When you need replacement parts, always request genuine U-Line replacements be used. Visit www.U-Line.com to locate a parts distributor in your area.

Échelon Series / Origins Series

U-Line Corporation, located in Milwaukee, WI, is a family operated manufacturer of built-in undercounter ice makers, Combo® ice maker/refrigerators, Wine Captain® wine storage units, refrigerators, refrigerated drawers and refrigerator/freezers.