

CARE AND USE MANUAL

Thermador Built-in Combination Ovens

Models:
DM301
DM302

Thermador[®] | *An American Icon*[™]

Questions?

1-800-773-2665

or

1-800-735-4328

www.thermador.com
Customer Support Call Center
Thermador
5551 McFadden Avenue
Huntington Beach, CA 92649

We look forward to hearing from you!

Contents

Important Safety Instructions	2 - 5	Defrosting Recommendations	33
Microwave Precautions and Registration	2	Upper/Lower Oven Mode Operations	34- 47
General Appliance, Oven and		Fast Preheat Operation	34
Microwave Oven Safety Precautions	3-4	Bake Mode Operation	34
Microwave Oven Safety Precautions	5	Bake Mode Tips and Recommendations	35
Oven Features and Information	6 - 14	Convection Mode Operation	36
Features of Your Oven	6	Convection Mode Tips	
Oven Control Features	7	and Recommendations	36
Interpreting the Control Panel	8	Convection Bake Mode Operation	37
Beep Volume	8	Convection Bake Tips	
Touch Panel	8	and Recommendations	37
F Number Codes	8	Roast Mode Operation	38
208 Volt Connection	8	Roast Mode Tips and Recommendations	38
Control Panel Display	9	Convection Roast Mode	
Setting the Timer	9	and Probe Operation	39 - 40
Setting the Clock	10	Convection Roast Tips	
Setting the Lights	10	and Recommendations	40 - 41
Heating Modes Available in Each Oven	11	Broil and Convection Broil Mode Operation	42
Microwave Modes Available only		Broil and Convection Broil Tips	42
in Upper Oven or Single Oven	12	Broil and Convection Broil	
General Tips Upper and Lower Oven	13	Recommendations	43
Preheating the Oven	13	Warm / Proof / Dehydrate Mode Operation	44
Suggestions for Operation	13	Timed Cook Operation	45
Baking Pans and Dishes	13	Delayed Timed Cook Operation	46
High Altitude Baking	13	Food Safety Guidelines	46
Condensation / Temperature Sensor	13	Setting the Sabbath Mode	47
Oven Racks	14	Oven Care and Cleaning	48 - 51
General Tips for Oven Racks	14	Tips for Self Cleaning the Oven	48
Self Cleaning the Racks	14	Self Clean Mode Operation	49 - 50
Rack Positions	14	Oven Finishes / Cleaning Method	51
Multiple Rack Cooking and Baking	14	Do-It-Yourself Maintenance	52 - 54
Cooksmart™ Modes	15 - 22	Removing the Lower Oven Door	52
Cooksmart™ Mode Operation	15 - 16	Replacing the Oven Light	53
Cooksmart™ 1 – Breads and Desserts	17 - 18	Changing to the 24-Hour Clock Format	53
Cooksmart™ 2 – Large Roasts and Poultry	19	Fahrenheit to Celsius	54
Cooksmart™ 3 – Small Roasts and Poultry	20 - 21	Voltage Change Option (240V to 208V)	54
Cooksmart™ 4 – Vegetables	22	Calibrating Oven Temperature	54
Cooksmart™ 5 – Frozen Cooked Foods	22	Beep Volume	54
How to Obtain Service	54	Problem Solving	55 - 56
Microwave Mode	23 - 33	Solving Baking Problems	55
Basics for Microwave Mode	23	Solving Operational Problems	56
Microwave Mode Operation	24-25	Thermador Built-In Oven Warranty	57
Fresh Vegetables	26	What is Covered/Not Covered	57
Microwave Shortcuts	27	Warranty Applications	57
Micro Broil Program	28 - 29	Location of Data Plate	57
Micro Broil Cooking Chart	29	Service Data Record	57
Custom Combination Program	30 - 32		
Defrost Mode	32		
Defrosting Tips	33		

MICROWAVE PRECAUTIONS AND REGISTRATIONS

PRECAUTIONS TO AVOID POSSIBLE EXPOSURE TO EXCESSIVE MICROWAVE ENERGY

- a) Do not attempt to operate this oven with the microwave door open, since open-door operation can result in harmful exposure to microwave energy. It is important not to defeat or tamper with the safety interlocks.
- b) Do not place any object between the oven front face and the door or allow soil or cleaner residue to accumulate on sealing surfaces.
- c) Do not operate the oven if it is damaged. It is particularly important that the oven door close properly and that there is no damage to the: (1) door (bent), (2) hinges and latches (broken or loosened), (3) door seals and sealing surfaces, inside window/glass area.
- d) The oven should not be adjusted or repaired by anyone except properly qualified service personnel.

OVEN MUST BE REGISTERED

Microwave Registration Card

- 1. Complete and mail the registration card. (The registration card is packed with this manual.)
- 2. If you are not the original purchaser of this appliance or if the card is missing, please establish your ownership by writing to us at:

THERMADOR
Microwave Registration
5551 McFadden Avenue
Huntington Beach, CA 92649
- 3. When writing to us about your oven, please be sure to include the model and serial number.

THIS APPLIANCE MUST BE REGISTERED WITH THERMADOR. PLEASE BE CERTAIN THAT IT IS.

NOTE: Do not operate the oven with any object trapped between the door and the oven front face.

Data Plate

Copy the model and serial numbers from the data plate (under control panel - see item 2, Page 6). Keep your invoice for warranty validation. Fill in the information below as a handy reference.

Dealer's Name

Service Center

Model Number

Dealer's Telephone Number

Service Center's Telephone Number

Serial Number & Date of Purchase

General Appliance, Oven and Microwave Oven

SAFETY PRECAUTIONS

Please read all instructions before using this appliance.



WARNING

When properly cared for, your new Thermador oven has been designed to be a safe, reliable appliance. Read all instructions carefully before using this oven. These precautions will reduce the risk of burns, electric shock, fire, and injury to persons or exposure to excessive microwave energy. When using kitchen appliances, basic safety precautions must be followed, including the following:

- Read and follow the specific PRECAUTIONS TO AVOID POSSIBLE EXPOSURE TO EXCESSIVE MICROWAVE ENERGY found on Page 2.
- This appliance must be properly installed and grounded by a qualified technician. Connect only to a properly grounded outlet. See “Grounding Instructions” found in the Installation Instructions.
- This appliance should be serviced only by a qualified service technician. Contact the nearest authorized service center for examination, repair or adjustment.
- Do not repair or replace any part of the oven unless specifically recommended. Refer service to an authorized service technician.
- Do not operate this appliance if it is not working properly or if it has been damaged, until an authorized service technician has examined it.
- Install or locate this appliance only in accordance with the Installation Instructions.
- Use this oven only as intended by the manufacturer. If you have any questions, contact the manufacturer.
- Do not cover or block any openings on this appliance.
- Use this appliance only for its intended use as described in this manual. Do not use corrosive chemicals, vapors, or nonfood products in this appliance. This type of oven is specifically designed to heat or cook. It is not designed for industrial or laboratory use. The use of corrosive chemicals in heating or cleaning will damage the appliance.
- Do not allow children to use this appliance, unless closely supervised by an adult. Children and pets should not be left alone or unattended in the area where the appliance is in use. Never allow children to sit or stand on any part of the oven.
- Do not store items of interest to children above the oven. If children should climb onto the appliance to reach these items, they could be seriously injured.
- When children become old enough to use the appliance, it is the legal responsibility of the parents or legal guardians to ensure that they are instructed in safe operation of the appliance by qualified persons.

To reduce the risk of fire in the oven cavity:

1. Do not store flammable materials in or near the oven.
2. Do not use water on a grease fire. Smother fire or use a dry chemical or foam-type extinguisher.
3. It is highly recommended that a suitable fire extinguisher be readily available and highly visible next to any cooking appliance.
4. Do not overcook food. Carefully attend oven if paper, plastic or other combustible materials are placed inside the oven.
5. Remove wire twist-ties from paper or plastic bags before placing in microwave oven.
6. Do not use the cavity for storage purposes. Do not leave paper products, cooking utensils or food in the cavity when not being used.
7. If materials inside the oven should ignite, keep oven door closed. Turn oven off and disconnect the circuit at the circuit breaker box.
8. Do not block any vent openings.
9. Be sure the blower fan runs whenever the oven is in operation. If the fan does not operate, do not use the oven. Call an authorized service center.
10. Never use the oven to warm or heat a room. This can damage the oven parts.
11. For personal safety, wear proper clothing. Loose fitting clothes or garments with hanging sleeves should never be worn while using this appliance.

Continued on next page

General Appliance, Oven and Microwave Oven Safety Precautions



GENERAL OVEN SAFETY

- Do not touch hot elements or hot interior surfaces of the oven.
- The heating elements may be hot even though they are dark in color. Interior surfaces of an oven become hot enough to cause burns.
- During and after use, do not touch or let clothing or other flammable materials contact the heating elements until they have had sufficient time to cool.
- The trim on top and on the sides of the oven door may become hot enough to cause burns.
- Use care when opening the oven door. Open slightly at first to let hot air or steam escape before removing or replacing food.
- Do not heat unopened food containers. Buildup of pressure may cause the container to burst and result in injury.
- Always place oven racks at desired level while oven is cool. If a rack must be moved while oven is hot, do not let potholder contact the hot elements.
- Tie long hair so that it doesn't hang loose.
- In the event that personal clothing or hair catches fire, drop and roll immediately to extinguish flames.
- Use only dry potholders. Moist or damp potholders in contact with hot surfaces may result in burns from steam.
- Do not use a towel or other types of bulky cloth in place of potholders. They may ignite if they touch a hot element.



WARNING

The California Safe Drinking Water and Toxic Enforcement Act requires businesses to warn customers of potential exposure to substances which are known by the State of California to cause cancer or reproductive harm.

The elimination of soil during self-cleaning generates some by-products which are on this list of substances.

To minimize exposure to these substances, always operate this oven according to the instructions in this manual and provide good ventilation to the room during and immediately after self-cleaning the oven.

SELF-CLEANING MODE SAFETY

- Confirm that the door locks and will not open before starting self-clean mode. If door does not lock, do not run self-clean; phone 800 / 735-4328 for service (see Page 54, for obtaining service.)
- Clean only oven parts listed in this manual.
- Keep surfaces of door and oven free of soil, especially where they meet. Refer to cleaning instructions on Page 51.
- Do not clean the door gasket. Care should be taken not to rub, damage, loosen or remove the door gasket. It is essential for a good seal.
- Do not use commercial oven cleaners or oven liner protective coating of any kind in or around any part of the oven.
- Before setting the self-clean mode, remove the broiler pan, oven racks, other utensils and excess, soft spillage.

MICROWAVE MODE SAFETY

- Do not tamper with, adjust or repair the door, safety interlock switches or any other part of the oven. Repairs must be done by a qualified service technician.
- Do not operate the microwave mode when the oven is empty. If food or water is not present to absorb the energy, the oven could be damaged with a risk of fire.
- Do not dry clothes, newspapers or other materials in the oven. Newspapers and paper bags are not suitable for cooking; a fire may result.
- Do not use recycled paper products unless they are labeled safe for microwave use. These products may contain impurities that may cause sparks and result in a fire.
- Always use potholders to remove food from oven when using the microwave mode. Heat is transferred from the HOT food to the cooking container.

REGARDING PET BIRDS

Birds have very sensitive respiratory systems. Keep pet birds out of the kitchen or other rooms where kitchen fumes could reach them. During Self Clean mode, fumes that may be harmful to birds are released. Other kitchen fumes, such as from overheating margarines and cooking oils, may also be harmful.

Microwave Mode Safety Precautions

IMPORTANT: Do not overcook food; fire could result. Proper cooking depends on selecting the correct power level and cooking time for the amount of food in the oven. Smaller portions of food that are cooked too long may catch fire. Always have food in the microwave oven when it is on to absorb the microwave energy. When using the oven at power levels below 100%, you can hear the magnetron cycling on and off. Condensation is a normal part of microwave cooking. Covered foods will not cause as much condensation as uncovered ones. Do not block oven vents. This oven is rated for 600 watts by using the IEC Test Procedure. When preparing foods, check food 1-2 minutes before the minimum time and add time accordingly.

FOOD ITEM OR PROCESS	DO	DON'T
Home Canning		<ul style="list-style-type: none"> • Heat, cook or can in closed glass jars or air tight containers. • Home can in the microwave as harmful bacteria may not be destroyed.
Drying		<ul style="list-style-type: none"> • Dry meats, herbs, fruits, vegetables, gourds, wood items or wet papers. • Dry nuts or seeds in the shell.
Foods with Nonporous Skins or Shells	<ul style="list-style-type: none"> • Pierce skins of potatoes, apples, whole squash, hot dogs and sausages so that steam can escape. • Puncture whole egg yolks before cooking to prevent bursting. 	<ul style="list-style-type: none"> • Cook eggs in the shell. • Reheat whole eggs.
Popcorn	<ul style="list-style-type: none"> • Use popcorn packaged for microwave ovens. • Refer to popcorn package for popping time. Set the time early to check popping. • Place popcorn package on a microwave-safe dish. 	<ul style="list-style-type: none"> • Leave oven unattended when popping popcorn. • Use brown paper bags or glass bowls to pop corn in. • Place popcorn package on oven rack or oven bottom.
Baby Food/Baby Formula	<ul style="list-style-type: none"> • Place baby food in a small dish and heat gently, stir often, and check temperature before serving. • Place nipples/cap on bottles after heating and shake thoroughly. Always "wrist test" before feeding. 	<ul style="list-style-type: none"> • Heat baby food in the original jars. • Heat bottles with nipples on. • Heat bottles with disposable liners.
General	<ul style="list-style-type: none"> • When using oven cooking bags, use plastic ties or cotton string to close bag. • Stir liquids before and after heating to help prevent "eruption." • Baked items with fillings should be cut open to allow steam to escape and avoid burns. • Pizza sauce can become extremely hot. Check temperatures before eating. 	<ul style="list-style-type: none"> • Use wire twist-tie to close an oven cooking bag. • Deep fat fry. • Use paper towels or cloths that contain a synthetic fiber woven into them (the fiber may cause the towel to ignite).

Features of Your Oven

**MODEL DM301
SINGLE OVEN**

**MODEL DM302
DOUBLE OVEN**

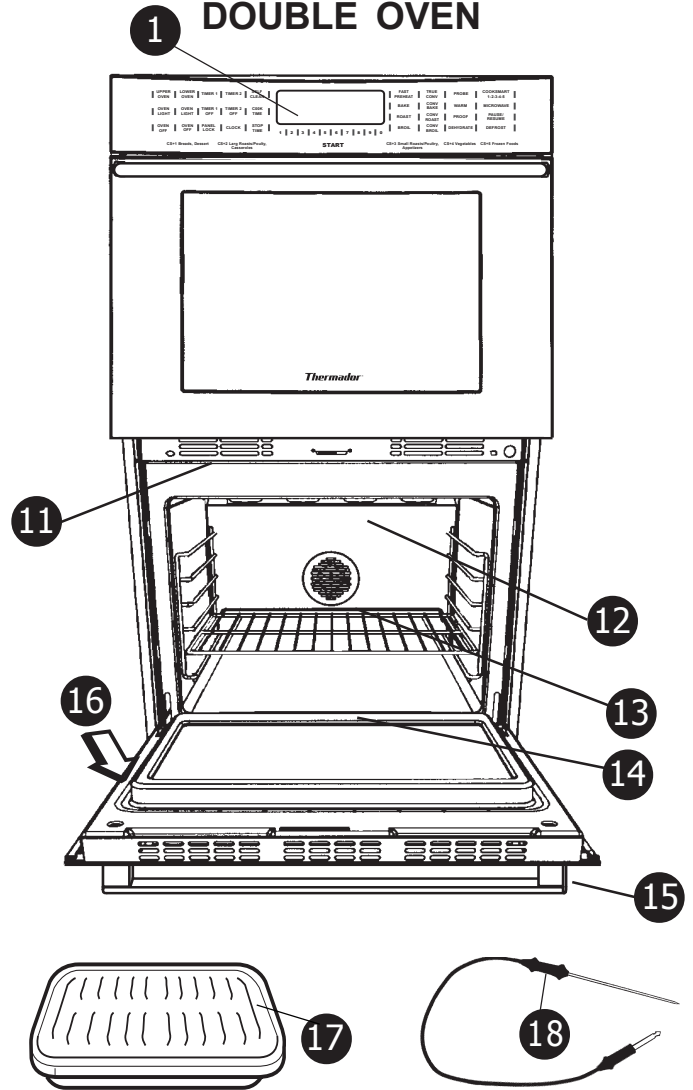
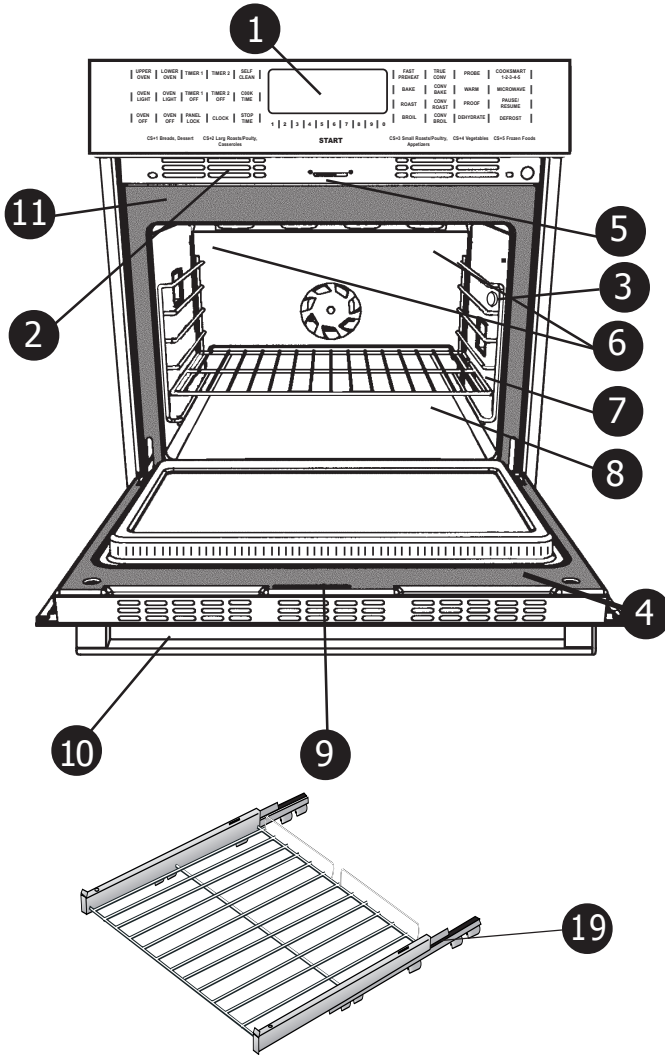

TOUCH CONTROL PANEL

1 Displays clock / time, oven modes and settings

UPPER OVEN

2 Data Plate (underside of control panel - open door)

3 Probe Receptacle (single oven or upper oven only)

4 Microwave Seal (single oven or upper oven only)

UPPER OVEN/LOWER OVEN

5 Door Lock Latch, automatic (one per oven)

6 Halogen Oven Lamps (2 in each oven)

7 Rack Supports; both ovens (See pg. 14)

8 Removable Racks (3 in each oven)

Remove racks before SELF CLEAN mode.

9 Door Gasket (one per oven)

10 Door Cooling Vents (both ovens)

UPPER/LOWER OVEN

11 Oven Cooling Vents (both ovens)

12 Broil Element (one in each oven)

13 Convection Fan and Baffle (one per oven)

14 Bake Element (under oven floor, one per oven)

LOWER OVEN

15 Removable Oven Door (lower oven only)

16 Oven Exhaust Vent and Trim
(at bottom, under double or single oven)

17 Enameled Broil Pan and Grid

18 Meat Probe

19 Extendable Rack. Remove from oven before SELF-CLEAN.

Oven Control Features

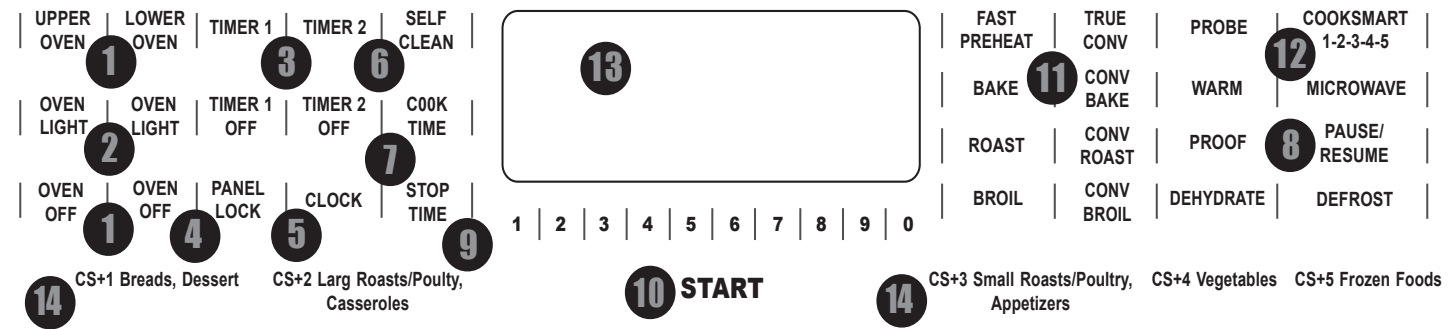

Note: Control Panel illustration is for a double oven model.

CONTROL MENU

- Oven Selector Pads
 - UPPER OVEN** – touch to turn upper oven **ON**.
 - OVEN LIGHT** – touch to turn the upper oven **OFF**.
 - LOWER OVEN** – touch to turn lower oven **ON**.
 - OVEN OFF** – touch to turn the lower oven **OFF**.
- OVEN LIGHT** – (two pads) Turns oven lights on or off for upper or lower oven.
- Timers – There are two timers that count down in minutes and seconds or in hours and minutes.
 - TIMER 1** (or **2**) and **TIMER 1** (or **2**) **OFF** – sets kitchen timers and turns timers off. See Page 9.
- PANEL LOCK** – also referred to as Child Lock-Out or Demo Mode; select this to prevent the control pads from being activated when oven is not being used. Touch and hold for 5 seconds to activate; repeat to cancel.
- CLOCK** – Use to set the time of day and timer(s) countdown.
- SELF CLEAN** – See Pages 48 - 50.
- Timed Cooking Pads
 - COOK TIME** – selects the hours to cook.
 - STOP TIME** – selects the time of day the oven is to automatically turn off.
- PAUSE/RESUME** – (Upper Oven Only) used with Microwave, Defrost and Cooksmart™ modes or Combination program to interrupt oven operation to check food.
- Number Pads – 1 through 0 – select a time of day, temperatures, Cooksmart™ mode, cook and stop time, or timer(s).
- START** – touch this pad to complete a timed entry or any oven mode.

11. Oven Mode Pads

- FAST PREHEAT**
- BAKE**
- ROAST**
- BROIL**
- PROBE**
- PROOF**
- TRUE CONVECTION**
- CONVECTION BAKE**
- CONVECTION ROAST**
- CONVECTION BROIL**
- WARM**
- DEHYDRATE**

12. Modes for Upper Oven Only

- Cooksmart™
- Microwave
- Defrost

13. Display Window (See Page 9 for illustration)

- Cooksmart™ – Describes food categories for each Cooksmart™ setting.

SPECIAL FEATURES and INDICATORS

- Sabbath Mode – complies with the Sabbath requirement. See Page 47.
- 12- or 24-hour Clock Choice – oven can have a 12-hour or 24-hour clock. See Page 53.
- Fahrenheit or Celsius – switch temperature scale to Fahrenheit or Celsius. See Page 54.
- Beep Volume – decrease or increase loudness of control panel tones. See Page 54.
- Calibrating Oven Temperature – used to calibrate the oven temperature. See Page 54.
- Default Temperature Settings – The cooking modes automatically select a suitable temperature. These can be changed when a different one is needed.

NOTE: In the event of a power failure, these functions return to the factory settings and will need to be reset.

The Control Panel: Sights & Sounds

Follow the control panel prompts to complete most oven functions. Familiarize yourself with the indicators below before beginning.

Flashing Symbols or Numbers

Signals an incomplete setting; complete the step or touch START.

1 Beep

Signals the receipt of an entry.

2 Beeps

Signal an error in entry.

4 Beeps

Signal the end of a setting.

Beep Volume

The volume of the beeps can be adjusted. Touch and hold the START pad followed by the PROBE pad for three seconds. Touch PROBE pad again to increase or decrease volume, from levels 1 to 3. Touch START to set volume selection.

Active Oven # Symbol

Indicates which oven was last set.

Probe Symbol

Displays the internal temperature of the meat rather than the oven roasting temperature. Oven temperature can be seen briefly by touching the cooking mode after touching START.

Door Lock Indicator

Displays during the Microwave, Defrost, Cooksmart™, Combination and Self Clean programs whenever the door is locked. Door can be opened when symbol no longer appears.

Pause

Displays when a Microwave, Defrost, Cooksmart™, or Combination program is paused or interrupted and door unlocks.

Err

Displays if an invalid temperature or time is entered.

Power Failure

After the power returns to the oven, the clock displays the time when the power was lost or turned off.

F Number Codes

Display when there is a problem with the signal sent to the electronic control board. See Solving Operational Problems, Page 56.

Convection Fan

Operates during any convection mode. The fan turns off if the door is opened. The convection fan will also run during the preheat time.

Component Cooling Fan

Activates during any cooking or self cleaning mode to cool inner components and outer door surfaces. This air is exhausted through the vent located below the lower oven in double oven models. It continues to run until components have cooled sufficiently.

208 VOLT CONNECTION

- Preheat time will be slightly longer.
 - Broil time will be slightly longer.
 - The Self Clean mode may need a longer clean time than normal, depending on the amount of soil.
-

Control Panel Display

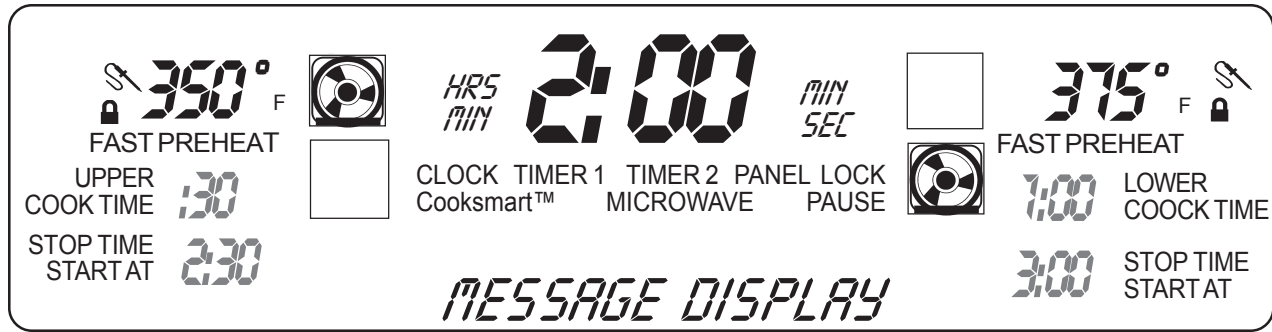

- Displays the oven in operation.
- Displays the time of day.
- Displays timer(s) countdown.
- Displays Panel Lock and Probe icons when activated.
- Displays selected modes, numbers, symbols and scrolling messages.

Setting the Timer

- The oven has two Timers, which are independent of each other. Neither timer controls oven operations.
- Touch once and the Timer is set in minutes and seconds.
- Touch twice and the Timer is set in hours and minutes.

To set **TIMER 1** or **TIMER 2**:

1. Select **TIMER 1** or **TIMER 2**.

Message scrolls in display.

Touch
TIMER 1

You Will See

TIMER 1  SEC
MIN

*TOUCH TIMER 1 AGAIN FOR HRS AND MIN THEN
SELECT LENGTH OF TIME THEN TOUCH START*

2. Set the amount of time.
(Example shows a 3-minute setting with Timer 1.)

Touch
3 0 0

TIMER 1 **3:00**
MIN SEC

3. Start Timer.

Touch
START

TIMER 1 **3:00**
MIN SEC

4. When set time is complete, "End" is displayed and 4 beeps signal. When turned off, display reverts to time of day.

Touch
TIMER OFF

END
TIMER 1

Note: If timer is not turned off, beeps will continue every 30 seconds. After 5 minutes, beeps stop and the display reverts to the previous time of day.

Continued on next page

Setting the Timer

(Continued from previous page)

To Cancel an Active Timer:

Select **TIMER 1 OFF** or **TIMER 2 OFF**.

To Set Both **TIMER 1** and **TIMER 2**:

- Follow the steps above to set each Timer. The Timer with the least amount of countdown time has display priority. The countdown display for the second timer is shown automatically when the first timer has ended.
- The words "**TIMER 1**" and "**TIMER 2**" are both displayed along with the number countdown.
- The designation, "**TIMER 1**" or "**TIMER 2**" with the least remaining countdown time is more brightly lit than the other word.
- During the countdown, touch **CLOCK** or **TIMER**. Depending on the pad touched, either the time of day or the remaining time is briefly displayed.

To Change a Timer:

1. Touch **TIMER 1** or **TIMER 2**.
 2. Enter the new desired time.
 3. Touch the **START** pad.
-

Setting the Clock

- Always set the clock after installation or after a power failure. Once power returns to the oven, the clock displays the time of day when power was turned off or lost.
- The Time of Day clock can be set while an automatic timed cooking mode is in operation.
- If 10 seconds elapse between touching the clock pad or number pads, the oven will beep two times as a reminder.
- After 5 more seconds, the clock pad will stop flashing and the original time will be displayed.

To Set the Clock:

1. Touch the **CLOCK** pad.
Message scrolls in display:
ENTER TIME OF DAY THEN TOUCH START
2. Set the current time of day.
Message scrolls in display:
ENTER TIME OF DAY THEN TOUCH START
3. Touch **START** or **CLOCK**.

Setting the Lights

- Touch **OVEN LIGHT** pad once to turn light on or off.
 - The lights do not operate in the Self Clean mode.
-

Heating Modes Available in Each Oven

The following illustrations give an overview of what happens in the oven with each mode. The arrows represent the location of the heat source during specific modes. The lower element is concealed under the oven floor.

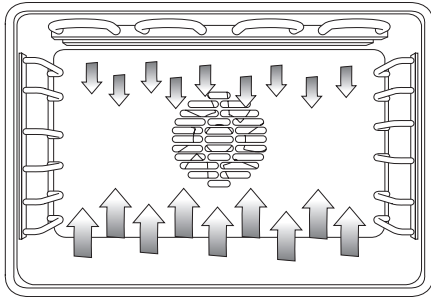

BAKE, PROOF or WARM

Baking is cooking with heated air. Both upper and lower elements are used to heat the air and cycle to maintain the temperature. Proofing, while similar to baking, holds an optimum low temperature for yeast to rise. Warm mode uses bottom heat to keep foods at optimum warm temperature.

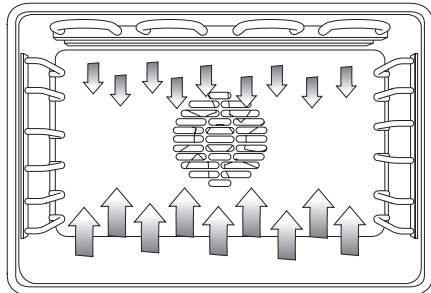

ROAST

Roast has more top heat than bake. This additional top heat is for conventional open roasting when drippings are desired or for covered-dish roasting.

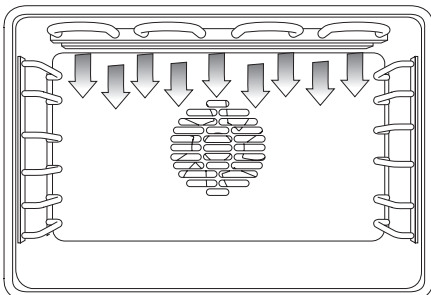

BROIL

Broiling uses intense heat radiated from the upper element to give excellent top browning or searing.

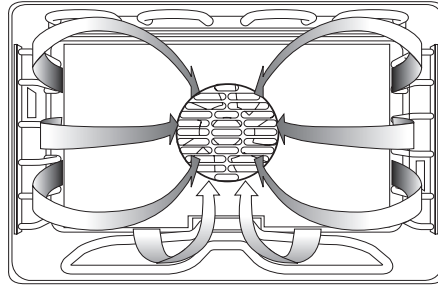

CONVECTION or DEHYDRATE

Convection cooking uses heat from a third element concealed behind the back wall of the oven. It also uses a fan to speed up the circulation of heated air throughout the oven. Dehydrate is similar to convection cooking and holds an optimum low temperature while circulating the heated air to remove moisture slowly for food preservation.

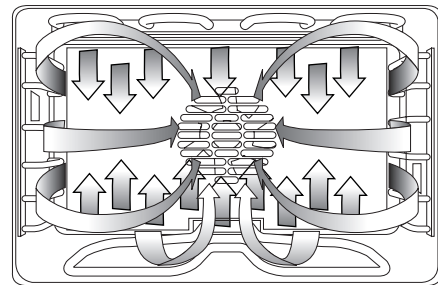

CONVECTION BAKE

Convection Bake has heat from the upper and lower element with circulation assisted by the convection fan. This mode is designed for breads and pastries.

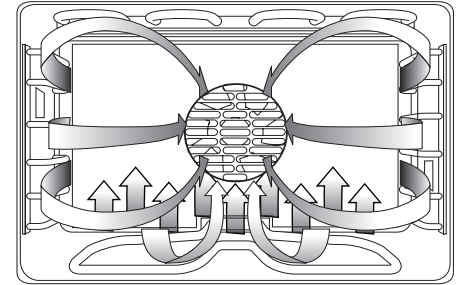

CONVECTION ROAST

Convection roasting combines the heat from the lower concealed element with additional heat from the convection element and fan. The result is a crispier exterior that seals in the interior juices. It is perfect for roasting tender meats in an uncovered, low-sided pan.

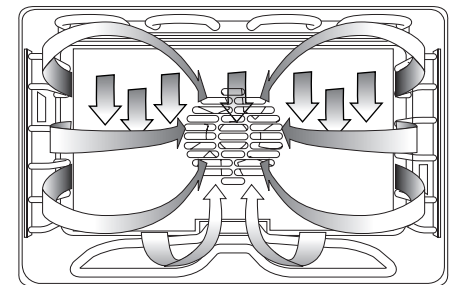

CONVECTION BROIL

Convection broiling combines the intense heat from the upper element with air circulation assisted by the convection fan. This air circulation crisps the exterior surface and retains inner moisture in meats more than 1-1/2" thick.

Microwave Modes available only in Single or Upper Ovens

The following illustrations give an overview of the heating activity with each mode setting. The arrows represent the heat source for specific cooking modes.

Cooksmart™ – This mode combines pre-programmed microwave energy and convection temperatures. Cooksmart™ settings cook in approximately one-half the standard cooking time. See Pages 15 – 22 for operation.

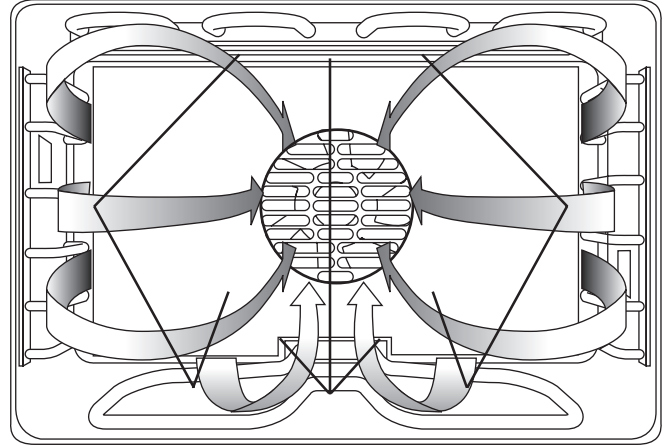

MICROWAVE – The microwaves enter through the plate in the top of the oven. Select from ten power levels when microwaving. See Pages 23 – 33 for operation.

DEFROST – Power level is programmed in control. Microwave energy only. See pages 32 and 33 for operation.

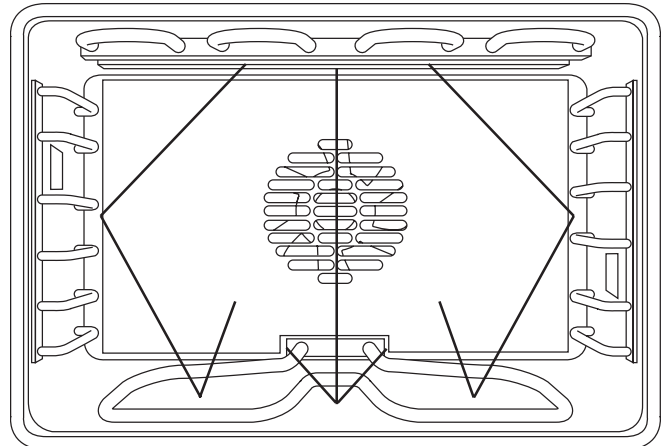

MICROBROIL – This mode combines microwave and broil settings. The intense heat from the upper element gives excellent top-browning and microwaves shorten the total cooking time. Microbroil is best for tender meat, poultry and fish that is more than 1-1/4 inches thick. See Pages 28 – 29 for operation.

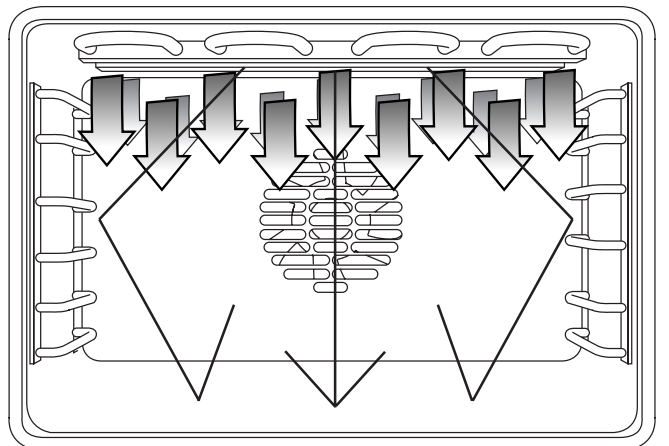

General Tips for Upper and Lower Oven

PREHEATING THE OVEN

- Place oven racks in desired position before heating the oven.
- Preheat the oven when using the BAKE, CONVECTION, ROAST and CONVECTION BAKE modes.
- Preheat is not used for BROIL and CONVECTION BROIL modes.
- Allow oven to preheat while preparing recipe ingredients or food item.
- Setting a higher temperature does not shorten preheat time.
- During preheat, the selected cooking temperature is displayed and alternates with a display of the actual oven temperature.
- The oven beeps once when it is preheated and the selected cooking temperature is displayed.
- Once oven is preheated, place food in the oven as quickly as possible to minimize the loss of heat and reduction of oven temperature.
- Use FAST PREHEAT to speed up preheating (See page 34).

SUGGESTIONS FOR OPERATION

- Use the cooking recommendations as a guide.
- Use the interior oven light to view the food through the oven door window rather than opening the door frequently.
- Use TIMER 1 or TIMER 2 to keep track of cooking times.
- Open the door as little as possible to avoid temperature reduction.

BAKING PANS AND DISH INFORMATION

- Glass baking dishes absorb heat; therefore, reduce oven temperature 25°F when baking in glass.
- Use pans that give the desired browning. For tender, light golden brown crusts, use light, anodized or shiny metal utensils.
- Dark, rough or dull pans (nonstick or anodized) will absorb heat and result in a browner, crisper crust. Some manufacturers recommend reducing the temperature 25° F when using this type of pan. Follow manufacturer recommendations.
- Insulated cookie sheets or baking pans may increase the length of cooking time.
- Do not set roasting pans or other baking pans on the open oven door.

- Do not keep the empty broiler pan in the oven during cooking as this could change cooking performance. Store the broil pan outside of the oven.
- Tips for “Solving Baking Problems” are found on Page 55.

HIGH ALTITUDE BAKING

- When cooking at high altitude with BAKE, CONVECTION, CONVECTION BAKE, ROAST or CONVECTION ROAST modes, recipes and cooking times will vary.
- For accurate information, write the Extension Service, Colorado State University, Fort Collins, Colorado 80521. There may be a cost for the guides. Specify which high altitude food preparation guide you prefer: general information, cakes, cookies, breads, etc.

CONDENSATION / TEMPERATURE SENSOR

- It is normal for a certain amount of moisture to evaporate from the food during any cooking process. The amount depends on the moisture content of the food. The moisture may condense on any surface cooler than the inside of the oven, such as the control panel.
- Your new Thermador® oven has an electronic temperature sensor that accurately maintains the temperature selected. Your previous oven may have had a mechanical thermostat that drifted gradually over time to a higher temperature. If you have adjusted your favorite recipe for use with your previous oven, you may have to adjust the time or temperature in your new oven.

Oven Racks

GENERAL TIPS

- **Placing racks in oven:** To insert racks into the oven, hold the rack with the back rail up and toward the back. Place the safety hooks under the front of the rail guides. Push the rack into the oven, lifting the rack stops over the front of the rail guides. Slide the rack into position.
- **Removing racks from oven:** To remove racks or reposition racks in the oven, pull the rack toward the front of the oven. Lift up the front of the rack over the safety stops and pull from the oven.
- Place oven racks in desired positions before turning the oven on.
- Oven rack supports should not be removed from the oven.
- **CAUTION!** Never use aluminum foil to cover the oven racks or to line the oven. It can cause damage to the oven if heat is trapped under the foil.
- When placing food on a rack, pull the rack out to the stop position. The racks are designed to lock and not tilt when pulled forward.

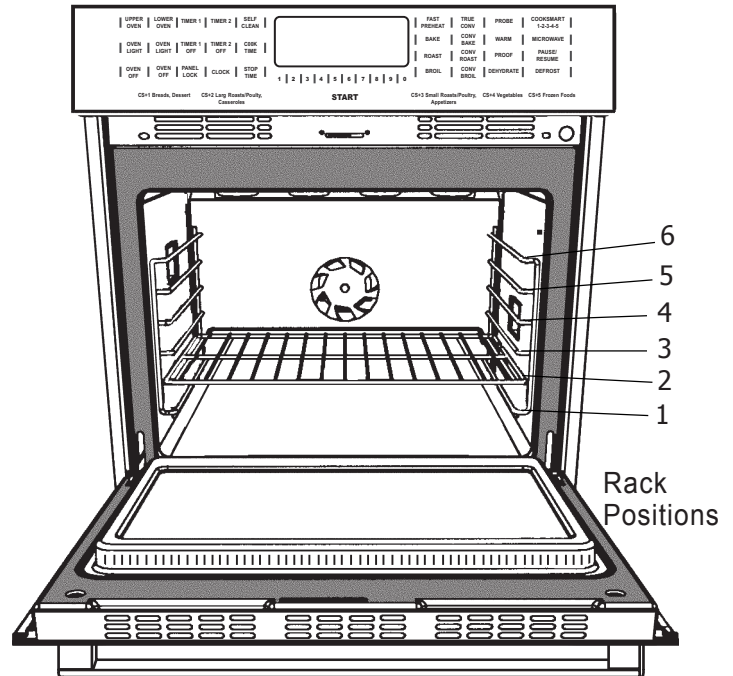

SELF CLEANING THE RACKS

- If the racks are left in the oven during Self Clean, the racks will lose the shiny finish. See Oven Care and Cleaning Recommendations on Page 51.

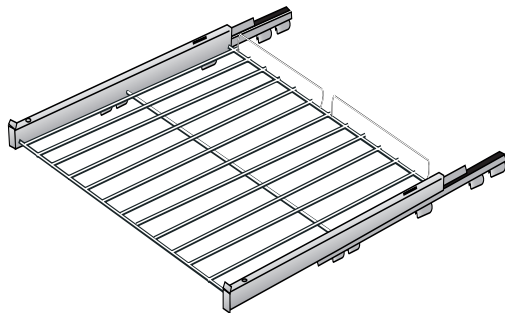

Always
remove
before
Self Clean

Extendable Rack

- The Extendable Rack (some models) must be removed before starting the Self Clean mode.

RACK POSITIONS

- Rack positions are numbered from the bottom support guide (#1) to the top (#6). The correct rack position for cooking a food item depends on the recipe and the cooking mode.
- Refer to the cooking recommendations in this manual for suggested rack positions.

MULTIPLE RACK COOKING AND BAKING

- Now you can cook a complete meal using multiple racks without flavor exchange from different foods.
- Check that cooking or baking temperatures are the same when cooking different foods at the same time.
- Two racks can be used at one time during BAKE mode, such as when baking a batch of cookies.
- Three racks or more can be used with convection modes.

Cooksmart™ Mode – Upper or Single Oven ONLY

Cooksmart™ combines convection heat and microwave energy to cook food in about half the conventional cook time (i.e. 12 minutes conventional time = 6 minutes Cooksmart™ time).

Cooksmart™ modes include:

CS1 - Breads, Desserts

CS2 - Large Roasts, Poultry, and Casseroles

CS3 - Small Roasts, Poultry, and Appetizers

CS4 - Vegetables

CS5 - Frozen Foods

- Each Cooksmart™ mode represents a pre-programmed combination of convection temperature with a microwave power level. Enter the longest cook time that is called for in your conventional recipe. Cooksmart™ will automatically reduce time entered when preheating starts.
- Set timer and check food when half of shortest recommended conventional time has elapsed.
- Always preheat before using a Cooksmart™ mode.
- Do not use Cooksmart™ mode when oven is empty.

- Select bakeware that is made of either metal, oven-safe glass or glass ceramic. Metal pans become hot quickly and will yield more browning. Do not cover food.
- Select rack level before selecting the CS mode. Remove all racks except one.
- Rack positions are numbered from the bottom (position #1) to the top (position #6).
- Do not allow metal pans to touch each other or arcing may occur.
- When using metal containers or foil, allow at least 1-inch (2.5 cm) spacing from oven walls.
- When using microwave, Cooksmart™ or combination modes, do not leave an oven thermometer in oven.
- Do not use paper towels in oven when using Cooksmart™ modes.
- Food soil is more substantial in the Cooksmart™ modes than in conventional oven modes. As a result, the oven may require more frequent self cleaning.
- Many factors affect cooking time. Always check food for doneness.

To Set a Cooksmart™ (CS) Mode

1. Select **UPPER** oven.

Touch
UPPER



2. Select **COOKSMART** Mode.

Touch
COOKSMART

CS -
UPPER



COOKSMART

Message scrolls in display. →

SELECT COOKSMART™ MODE THEN TOUCH START

3. Use number pads to select food group **1, 2, 3, 4** or **5** (See following pages for food group descriptions). The Example shows food group 1 selected.

Touch
1

CS 1
UPPER



COOKSMART

Message scrolls in display. →

COOKSMART™ 1 SELECTED

4. Select the longest conventional cooking time.

Touch
COOK TIME

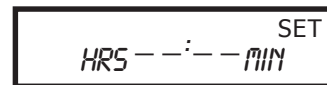

Message scrolls in display. →

ENTER COOKING TIME THEN TOUCH START

5. Use number pads to set conventional cook time. (Example shows 12 minutes).

Touch
1
2



- Tip: Cook time is displayed in conventional time in hours and minutes.

Message scrolls in display. →

ENTER COOKING TIME THEN TOUCH START

Continued next page

Cooksmart™ Mode – Upper or Single Oven ONLY

You Will See

6. Select **START** to preheat oven.
(Example shows cook time converted to Cooksmart™ time: 6:00 minutes.)
- When the oven reaches the correct temperature one beep will sound and the word "**PREHEAT**" disappears.

Touch **CS 1**
START **PREHEAT**
UPPER



MIN 6:00 SEC
COOKSMART
COOKSMART 1

7. After oven is preheated, add food.
- Motorized door latch locks door.
 - COOKSMART™ cook time countdown begins.

CS 1
UPPER



COOKSMART
ADD FOOD THEN TOUCH START
COOKSMART 1

Message scrolls in display. →

8. Touch **START** when door is closed.

Touch **CS 1**
START **UPPER**



MIN 5:59 SEC
COOKSMART
COOKSMART 1

9. To interrupt the mode or check doneness at minimum cooking time:
Pause the cooking process by selecting **PAUSE/RESUME**
- The door latch unlocks.
 - COOK TIME** stops counting down (example shows oven paused with 58 seconds remaining to cook).
To resume the cooking process close the door, touch **PAUSE/RESUME** pad again.
 - The door latch locks the door.
 - COOK TIME** resumes counting down.

Touch **CS 1**
PAUSE/
RESUME **UPPER**



MIN 0:58 SEC
COOKSMART PAUSE
COOKSMART 1

Touch **CS 1**
PAUSE/
RESUME



MIN 0:58 SEC
COOKSMART
COOKSMART 1

10. At the end of Cooksmart™ cooking mode:
- Oven beeps 4 times and the word "**End**" is displayed.
 - The door latch unlocks the door.
 - Oven will continue to beep as a reminder to check food until door is opened.
 - The display clears and stops beeping when the door is opened.

Touch **OVEN**
OFF
- or -
open the door

END

Message scrolls in display. →

COOKING COMPLETED -- REMOVE FOOD

11. To cancel a Cooksmart™ mode after the mode has started, touch **Upper Oven Off**.

- The door latch unlocks the door.
- Timer display reverts to the time of day.

To change time after Cooksmart™ is operating

- Touch **COOK TIME**
- Use number pads to select new COOK TIME.
- Touch **START**

To add more time to a Cooksmart™ mode after the original cooking time has ended:

- Repeat steps 1 through 5, touch **MICROWAVE** then touch **START**.

Touch **UPPER**
OVEN
OFF

Touch **START**

Touch **MICROWAVE**
START

Cooksmart™ 1 – Upper or Single Oven ONLY

CS1 - Guidelines for Breads and Desserts

- Preheat oven and bake using one rack at a time.
- Place rack in center of oven unless specified otherwise.
- Use the longest conventional baking time given in a recipe.
- Timings on the chart are a guide.
- Metal pans become hot quickly and brown more than glass or glass ceramic.
- Biscuits and cookies should be left on pan for 3 to 4 minutes after removal from oven.

CS1 FOOD ITEMS	RACK LEVEL	PAN SIZE AND TYPE	CONVENTIONAL COOK TIME
Breads, Yeast			
White Loaf, Scratch or Frozen	3	9x5 aluminum loaf pan	25 to 30 minutes
White Braid or Baguettes	3	15x12 cookie sheet	25 to 30 minutes
French Loaf	3	15x12 cookie sheet	40 to 45 minutes
Rolls			
Cinnamon	3	9x13 pan	20 to 25 minutes
Dinner, scratch	3	8" round pan or 12-cup muffin tin	15 to 20 minutes
Breads, Specialty			
Bread, Garlic, Fresh (1 lb.)	3	15x12 cookie sheet	18 to 22 minutes
Bread, Garlic, Frozen (1 lb.)	3	15x12 cookie sheet	20 to 24 minutes
Bread, Bruschetta (8 oz.)	3	15x10 ⁻¹ / ₂ x1 jelly roll pan	10 to 12 minutes
Focaccia	3	15x10 ⁻¹ / ₂ x1 jelly roll pan	35 to 40 minutes
Cornbread, Scratch			
	3	8x8 aluminum pan or pyrex	20 to 25 minutes
	3	12-cup muffin tin	15 to 18 minutes
Cornbread, Mix (1 lb.)			
	3	8x8 aluminum pan or pyrex	30 to 35 minutes*
	3	12-cup muffin tin	18 to 20 minutes
Quick Bread, Mix (14 oz.)			
Scratch	3	8x4 loaf pan	55 to 65 minutes
	3	8x4 loaf pan	50 to 55 minutes
Muffins			
Scratch Muffins, Nut Variety	3	12-cup muffin tin	15 to 20 minutes*
Scratch, Mini-Muffins, Nut Variety	3	12-cup mini-muffin tin	12 to 16 minutes*
Biscuits			
Refrigerator, Large (1 lb. 0.3 oz.)	3	15x12 cookie sheet	15 to 18 minutes*
Refrigerator, (12 oz.)	3	15x12 cookie sheet	8 to 11 minutes*
Crescent Rolls, refrigerated (8 oz.)	2	15x12 cookie sheet	11 to 13 minutes
Scones, 8 to 10	2	15x12 cookie sheet	12 to 15 minutes

* May need longer cooking time.

Chart continued next page

Cooksmart™ 1 – Upper or Single Oven ONLY

(continued from previous page)

CS1 FOOD ITEMS	RACK LEVEL	PAN SIZE AND TYPE	CONVENTIONAL COOK TIME
Brownies			
Fudge, Scratch	3	8x8 aluminum or Pyrex®	20 to 25 minutes
	3	9x13 aluminum or Pyrex®	20 to 25 minutes
Fudge, Mix (1 lb. 3 oz.)	3	9x13 aluminum or Pyrex®	28 to 30 minutes
Cakes, Specialty			
Angel Food, Mix (16 oz.)	1	10-inch aluminum tube	37 to 47 minutes
Bundt, Scratch	3	12-cup bundt	40 to 45 minutes
Carrot, Scratch	3	9x13 aluminum	35 to 40 minutes
Cheesecake	3	9" springform pan	35 to 40 minutes
Pineapple Upside-Down	3	8" round glass dish	30 to 35 minutes
Streusel Coffeecake, Mix	3	12-cup bundt	40 to 45 minutes
(1lb. 10.5 oz.)	3	9x13 aluminum or Pyrex®	35 to 40 minutes
Mix(18.3oz.)	3	8x8 aluminum or Pyrex®	25 to 30 minutes
Mix(10 oz.)	3	Pan included in package	21 to 26 minutes
Streusel Coffeecake, Scratch	3	9x13 aluminum or Pyrex®	45 to 60 minutes
Gingerbread, Mix	3	8x8 glass	20 to 25 minutes
Cookies			
Scratch, Bar	3	15x10-1/2x1 jelly roll pan	20 to 25 minutes
Scratch, Drop	3	15x12 cookie sheet	8 to 10 minutes
Scratch, Rolled and Cut	3	15x12 cookie sheet	7 to 8 minutes
Refrigerated Dough	3	15x12 cookie sheet	9 to 11 minutes
Pastry Crust			
Frozen	1	9" aluminum in package	7 to 9 minutes
Graham Cracker	3	9" Pyrex® pie pan	8 minutes
Pies, Cobblers, Fruit Crisps - fresh or frozen			
Pie, two-crust scratch, Apple or Cherry	1	8" or 9" aluminum or 9" Pyrex® pie pan	50 to 60 minutes*
Pecan	1	9" metal or Pyrex® pie pan	45 to 50 minutes
Pumpkin	1	9" metal or Pyrex® pie pan	55 to 65 minutes
Cream Cheese	3	9" Pyrex® pie pan	20 to 25 minutes
Cobbler, fruit, with biscuit topping	3	9x13 metal or glass or 2 quart deep dish	20 to 25 minutes
Crisp, fruit (peach or apple)	3	8x8 or 9 x 13 aluminum or Pyrex®	30 to 35 minutes
Quiche			
Pre-baked crust	1	9" Pyrex® pie pan	35 to 40 minutes
* May need longer cooking time.			

Cooksmart™ 2 – Upper or Single Oven ONLY

CS2 – Guidelines for Large Roasts and Poultry (over 4.5 lbs.) and Casseroles.

- Allow approximately 1/2 the conventional cooking time.
 - Use this mode for meats over 4.5 lbs.
 - Let refrigerated meats and poultry stand at room temp for 15-20 minutes before roasting. Prepare meats at this time.
 - Cook all large meat items on Rack 1, 2 or 3, depending on height.
 - Use bottom broiler pan of 2-piece broiler set.
 - For lamb, whole chicken or turkey, use V-rack in bottom broiler pan.
 - Preheat before placing food in oven.
 - Do not leave a meat thermometer in meat during roasting.
 - Check food at minimum roasting time for doneness.
 - After cooking, allow meat to stand covered with foil for 15-20 minutes before carving/serving.
- Food will continue to cook during recommended standing time, and temperatures will even out and will rise approximately 10-15 degrees during this time.
 - Oven probe cannot be used in this mode.
 - Refer to Page 49 for Food Safety Guidelines.

Tips for roasting a turkey:

- Remove wire leg clamp from turkey before roasting.
- To prepare turkey for roasting, tuck wings behind back and loosely tie legs with kitchen string.
- Cover top of breast and ends of legs with wide strips of foil. After half of the cooking time has expired, remove foil on breast area.
- Cook only unstuffed turkeys in this mode.

CS2 LARGE ROASTS, POULTRY, AND CASSEROLES	WEIGHT (OVER 4.5 lbs)	CONVENTIONAL COOK TIME Minutes Per Pound	DONENESS	
			END TEMP	CARVING TEMP
Lamb: Leg of Lamb (cover small end of leg with foil)	5 to 6 lbs.	22 to 23 minutes / lb.	Lamb should be removed from oven when internal temperatures reach 135 or 150°F. After covering with foil and standing, serving temps should be 145°F for medium rare and 160° for medium.	
Pork: Loin roast (tied double)	4.5 to 6 lbs.	24 to 26 minutes / lb.	155° F	160° F to 165° F
Turkey: Whole Breast, with bones, skin Whole turkey (netted), boneless	12 to 16 lbs. 17 to 21 lbs. 22 to 26 lbs. 4.5 to 7 lbs. 5 to 7 lbs.	13 to 15 minutes / lb. 11 to 13 minutes / lb. 9 to 12 minutes / lb. 19 to 21 minutes / lb. 13 to 15 minutes / lb.	Turkey should be removed from oven when internal temperatures reach 170° F in the breast and 180° F in the thigh. Cover with foil and allow to stand for 20 minutes for easier carving	
Beef: Rib Roast with bones Rib Eye Roast, boneless	4.5 to 6 lbs. 6.5 to 8.5 lbs. 4.5 to 6 lbs. 6.5 to 8.5 lbs.	23 to 25 minutes / lb. 17 to 20 minutes / lb. 19 to 21 minutes / lb. 16 to 19 minutes / lb.	Roast may be turned over halfway during cooking time. Beef should be removed from oven when internal temperatures reach 10° F less than serving temperature. After covering with foil and standing, serving temps should be 145° F for medium rare, 160° F for medium, 170° for well.	
Salmon: Whole filet	4.5 to 5.5 lbs.	35 to 42 minutes total	Fish should be removed from oven when it flakes with a fork.	

Tips for Casseroles:

- For best results, follow recipe directions for covering.
- Set time for half the longest conventional time.

Cooksmart™ 3 – Upper or Single Oven ONLY

CS3 – Guidelines for Small Roasts and Poultry (less than 4.5 lbs.) and Appetizers

- Allow approximately one-half the cooking time. Calculate the total minutes per pound and enter the total cook time.
- Preheat before placing food in oven.
- Cook all foods in center of rack level 3.
- Use the bottom of the two-piece broiler pan unless instructions specify a different pan or container.
- Cook all meats uncovered unless otherwise specified.
- Score fat on roasts before cooking.
- Brush lean cuts of meat and fish with vegetable or olive oil before roasting to prevent sticking.
- Check food for doneness with meat thermometer at minimum time.
- After cooking, allow meat to stand loosely covered with foil for 15 to 20 minutes.
- Food will continue to cook and internal temperature will rise during standing time.
- Do not leave a meat thermometer in meat during roasting.
- Oven probe cannot be used in this mode.
- Cook appetizers uncovered.
- For appetizers, cook for 1/2 the maximum conventional cooking time.
- Refer to Page 46 for Food Safety Guidelines.

CS3 SMALL ROASTS, AND POULTRY	WEIGHT (Under 4.5 lbs.)	CONVENTIONAL COOK TIME Minutes Per Pound	DONENESS
Beef: Tri-tip	1-1/2 to 3 lbs.	20 to 22 minutes / lb.	Beef and lamb should be removed from oven when internal temperature reaches 10-15° F less than serving temperature. Cover with foil and allow to stand 10 – 15 minutes. Temperature will rise 10 – 15°F during standing time. Serving temperatures should be 145°F – medium rare; 160°F –medium Space evenly on jelly roll pan.
Beef Loin – Top Sirloin Roast	3.5 to 4.5 lbs.	30 to 33 minutes / lb.	
Rib Eye Roast (boneless)	3 to 4.5 lbs.	22 to 24 minutes / lb.	
Rib Roast (with bones)	3 to 4.5 lbs.	23 to 24 minutes / lb.	
Tenderloin Roast	2 to 3 lbs.	22 to 23 minutes / lb.	
Meat Loaf, ground beef or turkey	1-1/2 lbs.	64 to 65 minutes total	
Meat Balls, ground beef or turkey	1 lb. (35-40 1-inch meatballs)	15 to 20 minutes total	
Lamb: Rack	1-1/4 to 2 lbs.	24 to 36 minutes / lb.	Space evenly on broiler pan. After removing, drain fat and cover with foil for 10 minutes.
Rack, Crown	3 to 4 lbs.	17 to 18 minutes / lb.	
Pork: Pork Tenderloin	3/4 to 1-3/4 lbs. each	36 to 44 minutes / lb.	End Temp: 155°F Carving Temp: 160°F to 165°F

Chart continued next page

CS3 – Guidelines for Small Roasts and Poultry, chart continued

CS3 POULTRY	WEIGHT	CONVENTIONAL COOK TIME	DONENESS
Chicken: Breasts - with skin & bones (place in pan with skin up)	1 to 1-1/2 lbs. 2 to 2-1/2 lbs. 3 to 4 lbs.	27 to 28 minutes / lb. 19 to 20 minutes / lb. 15 to 16 minutes / lb.	Whole chicken and cornish hens should be removed from oven when internal temperature reaches 165° – 175°F. Cover with foil and allow to stand 15 to 20 minutes. Temperature will rise 5°– 10°F during standing time and juices should run clear. Serving temperatures should be 170°F for breast; 180°F for thigh.
Breasts, Boneless, Skinless marinated	1/2 to 1 lb. 1 to 1-1/2 lbs. 1-1/2 to 2-1/2 lbs. 2-1/2 to 3-1/2 lbs. 3-1/2 to 4 lbs.	17 to 20 minutes total 21 to 25 minutes total 26 to 34 minutes total 33 to 39 minutes total 38 to 44 minutes total	
Pieces (place in pan with skin up)	1 to 1-1/2 lbs. 2 to 3 lbs. 3-1/2 to 4-1/2 lbs.	40 to 45 minutes total 45 to 50 minutes total 55 to 60 minutes total	
Whole, unstuffed (place on V-rack in bottom of two-piece broil pan)	3 to 5 lbs.	21 to 22 minutes / lb.	
Cornish Hens, unstuffed: 2 (place on flat rack in bottom of two-piece broil pan)	Approx. 1-1/2 lb. each	60 to 65 minutes total	
4 (place on flat rack in bottom of two-piece broil pan)	Approx. 1-1/2 lb. each	70 to 77 minutes total	
Fish:			Fish should be removed from oven when fish flakes with a fork. Remove small pieces that may cook faster. Thin ends of fillets should be folded under to make pieces as uniform in shape as possible.
Salmon Fillets (1-1/4" thick)	1/2 to 1 lb. 1-1/2 to 2 lbs.	28 to 30 minutes total 30 to 33 minutes total	
Salmon Fillets (1-1/2" thick)	2 to 3-1/2 lbs.	40 to 42 minutes total	
Salmon Steaks (1-1/4" thick)	1 to 1-1/2 lbs. 2 to 3 lbs.	24 to 36 minutes total 38 to 41 minutes total	
White, Fillets (1/2" to 3/4" thick)	1/2 to 1 lb. 1-1/2 to 2 lbs.	14 to 16 minutes total 15 to 17 minutes total	
White, Fillets (3/4" to 1" thick)	1 lb. 1-1/2 to 2 lbs.	18 to 19 minutes total 16 to 18 minutes total	
White, Steaks (1" to 1-1/4" thick)	3/4 to 1 lbs. 1-1/2 to 2 lbs.	15 to 17 minutes total 18 to 19 minutes total	

Tips on cooking poultry:

- Roast whole chickens breast-side up; tuck wings back and loosely tie legs with kitchen string.
- A basting sauce keeps the outside skin moist.
- Marinate boneless, skinless chicken breasts up 24 hours before cooking (for best results, marinate at least 30 minutes).
- Small pieces of aluminum foil may be used to cover poultry wings or legs to prevent overbrowning.
- Check inner thigh area for doneness with meat thermometer.
- This mode is not recommended for stuffed poultry.
- If roasting bags are used, cook time may need to be increased.

Cooksmart™ 4 – Upper or Single Oven ONLY

CS4 – Guidelines for Vegetables

- This mode is for fresh vegetables.
- Do not wrap baking potatoes in foil.
- Cook all items on Rack Level 3.
- Peel or pierce vegetables and fruits to prevent bursting.

CS4 VEGETABLES	PAN SIZE AND TYPE	CONVENTIONAL COOK TIME
Apples, baking, 4 large, halved	8x8 glass	25 to 30 minutes
Apples, baking, 4 large, whole	8x8 glass	40 to 45 minutes
Carrots, Roasted quartered & cut into 2" strips or cut into 1/2" rounds	Bottom of two-piece broil pan	30 to 35 minutes
Eggplant, peeled, rounds	Pyrex® 9x13	20 to 25 minutes
Mushrooms, large, stuffed	15x10-1/2x1 jelly roll pan	15 to 16 minutes
Potatoes, baking Large 10-12 oz. Medium 7-9 oz. Small 4-6 oz.	Place on oven rack Place on oven rack Place on oven rack	80 to 90 minutes 60 to 70 minutes 50 to 60 minutes
Potatoes, new, quartered, 1 lb.	9x9 aluminum pan	40 to 45 minutes
Potatoes, scalloped	9x13 Pyrex®	1 hour and 40 minutes
Potatoes, sweet, medium, 8-10 oz.	Bottom of two-piece broil pan	55 to 60 minutes
Squash, winter, halves, placed face down in dish	9x13 Pyrex®	50 to 55 minutes
Squash, winter, peeled, 1"x2" to 1"x3" pcs	Bottom of two-piece broil pan	20 to 25 minutes
Tomatoes, halves, baked	8x8 Pyrex®	20 to 25 minutes
Vegetables, assorted, roasted (1" pieces/12 cups)	Bottom of two-piece broil pan	45 to 50 minutes
Yams, whole, medium, 8-10 oz.	Bottom of two-piece broil pan	50 to 55 minutes
Yams, candied	9x13 Pyrex®	35 to 40 minutes

Cooksmart™ 5 – Frozen Cooked Foods

- Heat frozen packaged entrees, dinners, and casseroles in original container.
- Homemade frozen casseroles are cooked in the Lower Oven Bake mode.
- Small size frozen combination meals, i.e. less than 10 oz., are best cooked in the Microwave mode.
- To set cooking time, use the conventional oven time on the package (not microwave heating time). Use minimum recommended time and add more time if necessary.
- Follow package directions for removing cover, covering with foil, venting package, etc.
- Frozen items (20 ounces or more), such as lasagna or macaroni and cheese, may need more time. Rotate container in oven then add more time. If the food is prone to over-browning, it may be covered with foil during first half of the cook time
- Frozen fruit pies or cobblers are baked using Cooksmart™ 1 (Breads, Desserts). See Cooksmart™ 1 chart on Page 18.
- Frozen vegetables are cooked in the Microwave mode. Follow microwave instructions on package.
- Frozen fruit turnovers are baked using Cooksmart™ 1 mode.

Microwave Mode – Upper or Single Oven ONLY

Basics for Microwave Mode

Utensils

Recommended for Microwave Mode

- Glass ceramic (Pyroceram®) such as Corningware®
- Heat-resistant glass (i.e. Pyrex®)
- Microwave-safe plastics
- Paper plates and cups
- Microwave-safe pottery, stoneware, porcelain
- Most Dinner Plates (check manufacturer's recommendations or perform microwave-safe test (See "Tips" below).

Tips

- To check whether a dish or mug is safe to use in this mode, place empty cookware in the oven next to a glass measuring cup with 1 cup of water in it. Heat at 100% power for 1 minute. If the empty cookware is warm at this point, it should not be used with the microwave mode.
- Microwave energy may cause some arcing between metal objects. Small amounts of arcing are neither harmful nor hazardous.

Not Recommended for Microwave Mode

- Non-heat-resistant glass
- Food carton with metal handle
- Non-microwaveable plastics (i.e. margarine tubs)
- Styrofoam cups or containers
- Metal or plastic (non-microwaveable) commuter beverage container
- Recycled paper products (i.e. brown shopping bags)
- Metal twist ties
- Food storage bags
- Some plastic wraps (check label)

Recommended Disposable Covers

- Paper towels
- Wax paper
- Microwave-safe plastic wraps (vent so steam escapes). Do not allow plastic wrap to touch food.
- Parchment paper.

Food Selection

- Quantity – Larger food items will cook faster than smaller food items. A small amount of food, i.e. 4 Tbsp. butter, will take longer to heat because the oven cavity is large compared to the small amount of food.
- Content – Food with higher fat, sugar and liquid contents cook faster than those with lower contents. For example, eggs, cheese, mayonnaise, etc. cook very quickly.
- Density – A nonporous food, such as roast, takes longer to cook than a porous food such as bread.

(continued next column)

- Shape and Size – Uniform shapes and sizes cook more evenly.

**DO NOT RUN MICROWAVE MODE
WHEN OVEN IS EMPTY**

Cooking Techniques

- Arranging – Place food in a circular pattern with the thickest areas toward the outside of dish.
- Covering – Most foods cook and reheat more evenly when covered.
- Shielding – Cover thinner areas of food with foil to prevent over-cooking or defrosting too quickly, i.e. chicken drumsticks. Do not wrap baking potatoes in foil.
- Foil should not come closer than one inch to any surface of the oven.
-  CAUTION: Stirring and Turning – Liquids can become super heated beyond boiling when heated in the microwave. Stir liquids before and after heating to help prevent “eruption” because of overheating. Stir foods from the outer edges toward center of utensil or turn food over once during cooking.
- Standing Time – Allow food to stand to complete cooking.

Guide to Power Levels

HI = 600 watts

- | | |
|-----------|---|
| HI (100%) | Poultry, fish, fresh and frozen vegetables, casseroles, boil water, popcorn, pudding. |
| 9 (90%) | Reheat rice and pasta. |
| 8 (80%) | Reheat precooked food, seafood. |
| 7 (70%) | Cheese entrees. |
| 6 (60%) | Scrambled eggs, cakes. |
| 5 (50%) | Custards, pasta, tender meats: beef, ham, lamb, pork, veal. |
| 4 (40%) | Slow cook entrees and less tender meats covered with liquid. |
| 3 (30%) | DEFROST frozen uncooked or precooked food, simmer stews and sauces. |
| 2 (20%) | Reheat pancakes, tortillas, French toast. |
| 1 (10%) | Hold entrees at serving temperatures. |

Microwave Mode – Upper or Single Oven ONLY

Microwave Mode Operations

- Remove all racks except one.
- Use rack level 3, unless otherwise noted.
- Place food in center of rack.
- Rack positions are numbered from the bottom (position #1) to the top (position #6), see page 14.
- Oven cooks on HI (100% of power) unless another cooking power level is selected.
- Oven probe cannot be used in this mode.
- Microwave timer can be set for 99 minutes and 99 seconds. Always enter the seconds after the minutes, even if both digits are zeroes.
- Microwave can be used when oven is hot from previous cooking.
- If oven is hot from previous use, only heat-resistant utensils should be used. Take additional care when removing from oven.
- See Page 23 for recommended utensils.

- Select **UPPER OVEN**.
(in double oven models)

You Will See

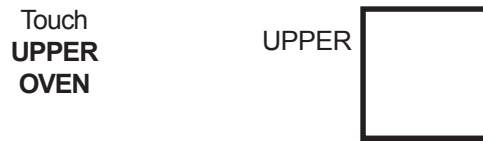

- Select Microwave mode.
Power level is preset for **HI**.

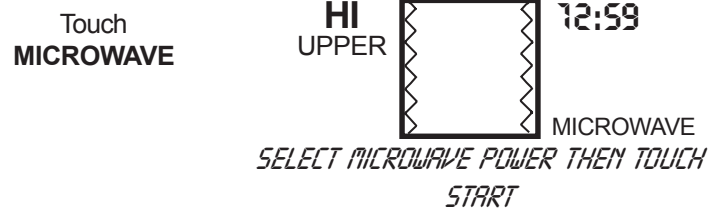

Message scrolls in display. →

- Optional step: To change cooking power level, select one number immediately before setting the cooking time. Do not touch the zero digit after the number.

The example shows a power level set at 30%.

- | | |
|---------------------|---------|
| 0 = HI (full power) | 5 = 50% |
| 9 = 90% | 4 = 40% |
| 8 = 80% | 3 = 30% |
| 7 = 70% | 2 = 20% |
| 6 = 60% | 1 = 10% |

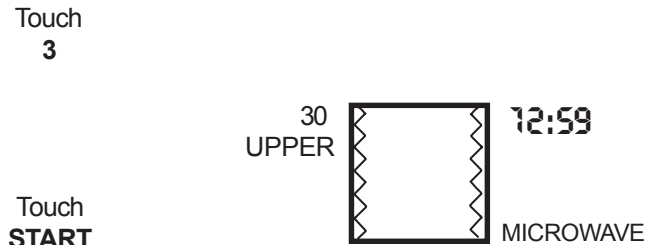

SELECT MICROWAVE POWER THEN TOUCH START

- Select the cooking time.
Use number pads to select minutes/seconds to cook in clock display window. (Illustration shows 5 minutes and 30 seconds selected.)

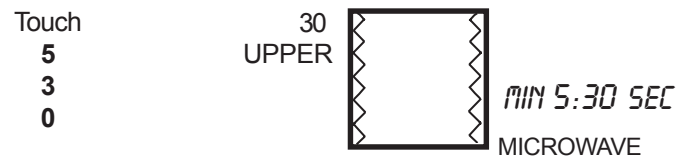

ENTER MICROWAVE TIME THEN TOUCH START

Message scrolls in display. →

Continued next page

Microwave Mode – Upper or Single Oven ONLY

5. Select **START**.

- Door latch will lock door.
- Cooking will start.
- Cook time will count down

Touch
START

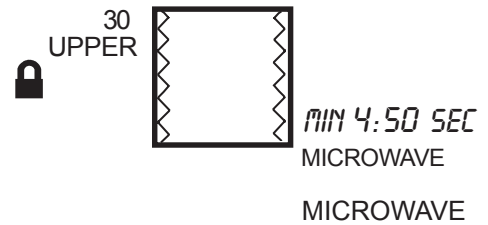

6. Optional step:

To check or stir food, select **Pause/Resume**.

- The microwave will stop; display shows remaining time.
- The lock symbol disappears when the door unlocks.

Touch
**PAUSE/
RESUME**

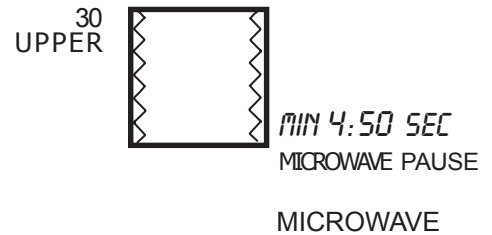

To resume microwave cooking, select **PAUSE/RESUME**.

- The door latch will lock the door; Microwave cooking will resume.
- Remaining cook time counts down in display.

Touch
**PAUSE/
RESUME**

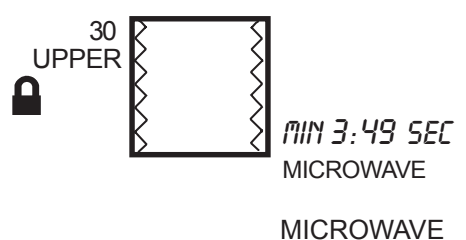

7. At the end of programmed cooking time:

- The word "**End**" lights in display.
- 4 beeps signal end of cooking.
- Microwave turns off.
- Door latch unlocks door.
- When door is opened, display again shows time-of-day.

Message scrolls in display. →

END

COOKING COMPLETED --- REMOVE FOOD

8. To end or cancel mode before cooking time has expired, turn off oven.

Touch
**OVEN
OFF**

9. To change microwave time when cooking, TOUCH **COOK TIME**.

- Use number pads to select new time.
- Touch **START**

To change the power level while cooking, touch **MICROWAVE**.

- Use number pad to select new level.
- Touch **START**

Touch
**MICROWAVE
COOK TIME
START**

Microwave Cooking – Upper or Single Oven ONLY

COOKING FRESH VEGETABLES

- Cook on rack level 3 on HI power.
- Times are for vegetables peeled, trimmed and ready to cook.
- Stir or rearrange vegetables once during cooking.
- Allow vegetables to stand covered 2-3 minutes before serving.

VEGETABLE	AMOUNT (purchased weight)	CONTAINER Type & Size	WATER OR PREPARATION METHOD	APPROX. COOKING TIME
Asparagus, spears	1 lb. (454g)	1-quart w/lid	1/4 cup (50 ml)	5 to 7 minutes
Beans, green or wax, cut in pieces	1 lb. (454g)	1-quart w/lid	1/4 cup (50 ml)	11 to 13 minutes
Broccoli, cut in pieces	1 lb. (454g)	1-quart w/lid	1/4 cup (50 ml)	9 to 11 minutes
Brussels sprouts	10 oz. (280g)	1-quart w/lid	1/4 cup (50 ml)	9 to 12 minutes
Cabbage, wedges	1 lb. (454g)	1-quart w/lid	1/4 cup (50 ml)	9 to 10 minutes
Carrots, baby	1 lb. (454g)	1-quart w/lid	1/4 cup (50 ml)	7 to 9 minutes
Carrots, sliced	2 cups	1-quart w/lid	2 tbsp. (30 ml)	8 to 10 minutes
Cauliflower, cut in pieces	1 lb. (454g)	1-quart w/lid	1/4 cup (50 ml)	9 to 11 minutes
Corn, on the cob (husks and silks removed)	1 ear 2 ears	Rinse ears and wrap tightly in wax paper, twist ends of paper.	none	5 minutes 7 to 8 minutes
Potatoes, baking Medium (6-8 oz. each)	1 2 3	No container. Wash and scrub well. Pierce with fork.	none	8 to 9 minutes 12 to 13 minutes 15 to 16 minutes
Potatoes, baking Large (10-12 oz. each)	1 2 3 4	No container. Wash and scrub well. Pierce with fork.	none	10 to 11 minutes 14 to 15 minutes 17 to 18 minutes 19 to 20 minutes
Potatoes, red, boiling – cut into 1" to 1-1/2" pieces	1 lb. (454g) 2 lbs. (908g)	1-quart w/lid 2-quart w/lid	1/4 cup (50 ml) 1/4 cup (50 ml)	6 to 7 minutes 11 to 13 minutes
Spinach, leaf	1 lb. (454g)	3-quart w/lid	None	7 to 9 minutes
Squash, Acorn Large – 1 to 1-1/2 lbs.	1 whole	9x9 baking dish Cover with plastic wrap.	Cut in half	12 to 14 minutes
Zucchini, sliced	1 lb. (454g)	1-quart w/lid	1/4-cup (50 ml)	6 to 8 minutes
Yams, whole Medium, 8 – 10 oz. Large, 12 – 15 oz.	1 medium 2 medium 4 medium 1 large 2 large	Place in glass baking dish.	Wash & scrub well. Dry & pierce with fork before baking.	8 to 10 minutes 13 to 15 minutes 16 to 17 minutes 16 to 18 minutes 18 to 20 minutes

Microwave Cooking – Upper or Single Oven ONLY



- Place all items below on rack level 3.

FOOD ITEMS (AMOUNT/WEIGHT)	POWER LEVEL	APPROX. TIME	PROCEDURES
Beverage/Cup of Soup - 6 oz.	100% (High)	3-1/2 minutes	Place bowl or cup in center of oven.
Butter, 1 stick (1/2 cup) - melted	70%	4 minutes	Remove wrapper and place butter in dish, covered with plastic wrap. Stir once when melting.
Butter, 1 stick (1/2 cup) - softened	30%	3 minutes	Remove wrapper and place butter in dish, covered with plastic wrap.
Chocolate Chips, 1/2 cup – melted	100% (High)	4 minutes	Place chocolate chips in dish. Stir once during melting. Note that chocolate will hold shape even when melted.
Chocolate, Baking 1 square, 1 oz.	100% (High)	3-3/4 minutes	Will hold shape even when softened.
Ground Beef, 1 lb. lightly browned	100% (High)	5 minutes	Crumble into dish. Cover with microwave-safe plastic wrap, venting one corner. Stir twice during browning time. Drain grease.
Popcorn, 3.0 oz. or 3.5 oz. pkg. (Prepackaged Microwave Popcorn only)	100% (High)	5 minutes or until popping slows to 2 seconds between pops.	Time may vary depending on package size. Pop one bag at a time, placing in center of oven. After popping, open bag carefully, away from face and body since popcorn and steam are extremely hot. Do not reheat unpopped kernels or reuse bag. Place popcorn package on a microwave-safe dish (such as a Pyrex® pie plate) for best results.
Potatoes, Baking Medium (6-8 oz.)	100% (High)	1: 8 to 9 minutes 2: 12 to 13 minutes 3: 14 to 15 minutes 4: 15 to 16 minutes	Wash & scrub well. Pierce with fork. Place on rack in circle. Allow to stand 5-10 minutes before serving.
Potatoes, Baking Large (10-12 oz. each)	100% (High)	1: 10 to 11 minutes 2: 13 to 14 minutes 3: 16 to 17 minutes 4: 17 to 18 minutes	Wash & scrub well. Pierce with fork. Place on rack in circle.

Micro Broil Mode – Upper or Single Oven ONLY

- Do not Preheat.
- Oven door will lock during this program.
- Always use the two-piece broil pan packaged with your oven.
- Use MICRO BROIL when broiling meats, fish or poultry pieces more than 1" thick.
- Do not run Micro Broil mode when the oven is empty.

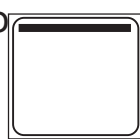
To set the Micro Broil mode:

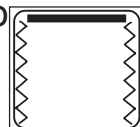
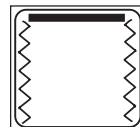
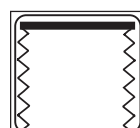
	Touch UPPER OVEN	<u>You Will See</u>
<p>1. Select UPPER OVEN.</p> <p>2. Select BROIL. The temperature is automatically set at HI (550°F/ 288°C).</p> <p>Message scrolls in display. →</p>	<p>Touch BROIL</p>	<p>550°  3:29</p> <p>UPPER</p> <p><i>BROIL HI - TOUCH BROIL FOR OTHER LEVELS THEN TOUCH START</i></p>
<p>3. Touch BROIL to toggle from Broil High (550°), Broil Medium (500°) and Broil Low (450°) temperature levels. Select desired level</p> <p>Message scrolls in display. →</p>	<p>Touch BROIL</p>	<p>500° </p> <p>UPPER</p> <p><i>BROIL MEDIUM SELECTED (OR) BROIL LOW SELECTED</i></p>
<p>4. Select START.</p>	<p>Touch START</p>	<p>500° </p> <p>UPPER BROIL</p>
<p>5. Select MICROWAVE mode. (Power Level is preset for HI)</p>	<p>Touch MICROWAVE</p>	<p>500° </p>
<p>6. Optional step: To change power level, select one number immediately before setting the cooking time. Do not touch the zero digit. Example shows a power level set at 20%.</p>	<p>Touch 2</p>	<p>20 </p>
<p>7. Select COOK TIME.</p>	<p>Touch COOK TIME</p>	<p>20  MIN --- SEC MICROWAVE</p>

Continued next page

Continued from previous page

8. Use number pads to select cook time.
Example shows 15 minutes selected.

Message scrolls in display. →

Touch

1
5
0
0**You Will See**

20

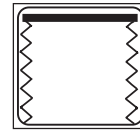

MIN 15:00 SEC

MICROWAVE

MICROWAVE

9. Select **START**.

Touch
START

20

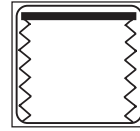

MIN 15:00 SEC

MICROWAVE

MICROWAVE

10. Optional step:

To check food for doneness, or to turn over at half time, use **PAUSE/RESUME**. See Item 9, Page 16.

Touch
PAUSE
RESUME

11. At the end of programmed cooking time:

- Word "**End**" lights in display.
- 4 beeps signal end of cooking.
- Microwave turns off.
- Door latch unlocks door.
- When door is opened, display again shows time-of-day.
- Broil setting remains on until **OVEN OFF** is selected.

Micro Broil Cooking Chart

- Start poultry with skin side down.
- Turn food over at about one-half of total cooking time. Fish items do not need to be turned.
- Check food for doneness at minimum time.
- Food will continue to cook during recommended standing time. (See * below).
- Clean broil pan and grid after each use. Do not allow grease and fat to accumulate and remain in pan.
- Do not use other pans for broiling, such as cookie sheets, cake pans, half sheet pans or jelly roll pans.

MICROBROIL MEATS	WEIGHT	RACK LEVEL	BROIL	MICROWAVE POWERLEVEL	TOTAL COOKTIME
Beef: London Broil*	2 lbs. to 3 lbs.*	5	MED 500°F	20%	21 to 23 minutes
Tri-tip Roast*	1-1/2 to 3 lbs.*	5	MED 500°F	20%	20 to 22 minutes
Steaks Fillet Mignon*	1" thick 1-1/2" thick*	5 5	MED 500°F HI 550°F	20% 20%	9 to 10 minutes 10 to 11 minutes
Chicken: Pieces, bone-in*	3-1/2 to 4-1/2 lbs.	4	HI 550°F	20%	20 to 22 minutes
Breast halves, * bone-in	3-4 lbs.	4	HI 550°F	20%	17 to 20 minutes
Fish: Steaks/Fillets	Approx. 1" thick	5	HI 550°F	20%	7 to 10 minutes
Lamb: Chopsw/bone*	Approx. 1" thick Approx. 2" thick*	5 5	MED 500°F HI 550°F	20% 20%	9 to 10 minutes 10 to 11 minutes
Pork: Chopsw/bone	Approx. 1" thick	6	MED 500°F	20%	9 to 10 minutes

* Allow these items to stand loosely covered with foil for 5-10 minutes before carving/serving.

**CAUTION!**

When broiling, open the door carefully. There may be an accumulation of steam and smoke. Do not place the hot broiler pan on the open oven door. Many factors affect cooking performance. Always check food for doneness.

Custom Combination Program – Upper Oven

Programming Convection with Microwave

- Custom Combination allows the combination any oven temperature with any microwave power level and select time.
- Select the cooking mode and oven temperature and preheat.
- After the oven is preheated, set the microwave power level and cooking time.
- Select low-sided cookware without a cover that is made of either metal, oven-safe glass or glass ceramic.
- Do not use paper towels when using a Custom Combination.
- Custom Combination cannot be used with proof, warm or dehydrate.
- Do not leave a meat thermometer in meat during roasting.
- Oven probe cannot be used in custom combination program.
- Place food in the center of the oven on Rack 3.
- Rack positions are numbered starting from the bottom of the oven, with Rack 1 closest to the bottom.
- A microwave cooking time cannot exceed 1 hour 40 minutes without being reset.
- When the beep signals the end of the cooking time, the microwave turns off automatically while the oven elements remain on.

To set a customized program:

1. Select **UPPER OVEN**.

Touch
**UPPER
OVEN**

You Will See



UPPER OVEN SELECTED

Message scrolls in display. →

2. Select **CONVECTION**.

The temperature is automatically set at 325°F.

Touch
CONVECTION

325°
UPPER



CONVECTION

3. Select a temperature.

To change the temperature from 325°F, select another temperature immediately before starting.

Touch
**3
5
0**

350°
UPPER



CONVECTION

Message scrolls in display. →

SELECT CONVECTION TEMPERATURE THEN TOUCH START

4. Select **START**.

The temperature display alternates between the set temperature and the actual temperature.

When the oven is preheated, the beep signals once.

PREHEAT no longer appears in the display.

Touch
START **100° / 350°**
**PREHEAT
UPPER**



CONVECTION

5. Select the **MICROWAVE** mode.

Power level is preset for HI.

Touch
MICROWAVE

HI



MICROWAVE

Message scrolls in display. →

SELECT MICROWAVE POWER THEN TOUCH START

Continued next page

Continued from previous page

You Will See

6. Select a power level.

While the HI power is flashing, select the power level immediately before setting the cooking time. The example shows a power level of 40%.

- | | |
|-------|------------------------|
| 1=10% | 6=60% |
| 2=20% | 7=70% |
| 3=30% | 8=80% |
| 4=40% | 9=90% |
| 5=50% | 0=100% (HI/full power) |

Touch
4



MICROWAVE

Message scrolls in display. →

SELECT MICROWAVE POWER THEN TOUCH START

7. Select **COOK TIME**.

Use the number pads to enter the cooking time. The example shows 7-1/2 minutes or 7 minutes: 30 seconds.

Message scrolls in display. →

Touch
7
3
0



MIN 7:30 SEC

MICROWAVE

ENTER MICROWAVE TIME THEN TOUCH START

9. Add the food and select **START**.

- Door Latch will lock door.
- Cooking with heat and microwaves will begin when door is locked.
- Cook time will count down.

Touch
START



MIN 7:30 SEC

MICROWAVE



10. To check or stir the food, select **PAUSE/RESUME**.

Touch
PAUSE/
RESUME

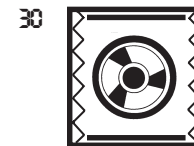

MIN 4:50 SEC

MICROWAVE PAUSE

CONVECTION

Continued next page

11. To resume cooking, select **PAUSE/RESUME**.

Touch
**PAUSE/
RESUME**



Message scrolls in display. →

CONVECTION

12. At the end of the set cooking time, **END** lights in the display and 4 beeps signal. The oven elements remain on until the **UPPER OFF** pad is touched.

Touch
**UPPER
OFF**

END

CAUTION: Many factors affect cooking performance. Always check food for doneness.

Message scrolls in display. →

COOKING COMPLETED -- REMOVE FOOD

13. To change the microwave time, without resetting the entire program, touch **MICROWAVE**.

Touch
MICROWAVE

Select **COOK TIME**.

COOK TIME

Enter the new time and touch **START**.

START

Defrost Mode Operation

To set DEFROST mode:

1. For double ovens, select upper oven.
2. Select **DEFROST**.

Message scrolls in display. →

ENTER DEFROST TIME THEN TOUCH START.

3. Enter cook time in minutes/seconds.
 - a. Use number pads to select minutes/seconds to cook.
 - b. When necessary, the amount of time entered will be converted to hours and minutes.
4. Select **START**. Door latch will lock door and defrosting begins.

At automatic pause, oven shuts off, message scrolls in display and oven beeps.

ROTATE AND TURN FOOD THEN TOUCH START.

5. At the end of defrosting time:

- The word "**END**" appears in display.

Message scrolls in display. →

COOKING COMPLETED - - - REMOVE FOOD

- 4 beeps signal end of cooking
- Defrost mode turns off
- Door latch unlocks door.
- When door is opened, display again shows time-of-day.

If food is not removed at end of defrost, the oven beeps once a minute for 10 minutes.

To change DEFROST time while oven is operating:

- Touch **COOK TIME**.
- Select new time using number pads.
- Touch **START**.

Defrosting Tips and Recommendations

- Defrost uncooked meat, fish and poultry using the DEFROST mode.
- Defrost mode is programmed using 30% microwave power.
- No thermal heat is used during DEFROST mode.
- The convection fan also runs during the DEFROST mode to help speed up defrosting.
- Center items on rack level 3 when defrosting.
- Remove store wrap and place in a shallow microwaveable container to catch juices.
- Use the chart below as a guide for determining defrosting time.
- When calculating defrosting time, allow 4 to 5 minutes per pound.
- Oven will pause automatically for rotating or turning food.
- Add more time in one minute increments until food is defrosted.
- Allow meat to stand covered after removing from oven to complete defrosting.
- Casseroles, sauced foods, vegetables and soups should be defrosted using HI (100%) microwave power level. Stir once or twice during defrosting to redistribute heat.

FOODITEMS	PROCEDURE	APPROX. DEFROST TIME (Minutes per pound of weight)
Bacon 1 lb.	Remove from wrapper. Place on dish lined with paper towels. Defrost until slices can be separated easily.	5 to 6 minutes
Beef: Ground 1 lb.	Remove thawed portions halfway through defrost time. Turn meat over and continue defrosting. Allow to stand 5-10 minutes.	5 to 6 minutes
Steaks 1 to 4 steaks	Turn steaks over and rearrange halfway through defrost time. Cover thawed areas with aluminum foil. Allow to stand 5-10 minutes.	8 to 11 minutes
Fish: Fillets/Steaks 1 lb. 2 lbs. 3 lbs.	Halfway through defrost time, turn pieces over and continue defrosting. If possible, separate and rearrange pieces. Let stand 5 to 10 minutes to complete defrosting.	3 to 4 minutes 5 to 6 minutes 7 to 8 minutes
Lamb Chops 1 to 4 chops	Turn over and rearrange halfway through defrost time. Allow to stand 5-10 minutes.	8 to 11 minutes
Chicken - Pieces 1 to 3 lbs.	Break apart pieces and turn over halfway through defrost time. Allow to stand 5-6 minutes.	10 to 13 minutes
Cornish Game Hens 1 to 4 hens, 1.5 lbs. each	Halfway through defrost time, remove birds from package, rotate and turn over. Shield end of legs, wings and any warm areas with foil. Allow to stand 8-10 minutes.	8 to 9 minutes
Ground Turkey 1 lb.	Remove thawed portions halfway through defrost time. Turn meat over and continue defrosting. Let stand 5-10 minutes.	5 to 6 minutes

Upper/Lower Oven Operations

Fast Preheat Operation

FAST PREHEAT can be used to preheat the oven faster.

To use FAST PREHEAT:

- Always select the cooking mode first. Change the oven temperature if necessary.
- Then touch FAST PREHEAT.
- Then touch START.
- Fast Preheat can be used with TIMED COOK and DELAYED TIME COOK.

Bake Mode Operation

To set Bake mode:

You Will See

1. For double ovens, select upper or lower oven.

2. Select **BAKE**.
The temperature is automatically set at 350°F.

Touch
BAKE

350°  2:57
(Clock time)

UPPER

Message scrolls in display. →

SELECT BAKE TEMPERATURE THEN TOUCH START

3. To change the temperature
To change the temperature from 350°F, select another temperature.

Touch
3 7 5

375° 
UPPER

4. Select **START**.
The temperature display alternates between the set temperature and the actual temperature, beginning with 100°F.
The oven is preheated when the beep signals once.
PREHEAT no longer appears in the display.

Touch
START

100° / 375°  3:27
PREHEAT
UPPER

 **BAKE**

5. To end this mode, select **OVEN OFF**.
6. To **change oven temperature during cooking**, touch the oven mode being used.
Touch number pads for another temperature.
Touch **START**.

Bake Mode Tips

- Preheat when using the Bake mode.
- Baking time will vary with the size, shape and finish of the baking utensil. Dark metal pans or nonstick coatings will cook faster with darker results. Insulated bakeware will lengthen the cooking time for most foods.
- For best results, bake food on a single rack with at least 1-1/2" space between pans or dishes and oven walls.
- Use a maximum of 2 racks when selecting the bake mode. Stagger pans so that one is not directly above another.
- To reduce heat loss, avoid opening the oven door. Whenever possible, check food through the window.
- Do not use any aluminum foil or a disposable aluminum tray to line any part of the oven. This will alter the cooking performance and can damage the finish of the oven.

Bake Mode Recommendations

The BAKE mode can be used to prepare a variety of food items, from pastries to casseroles. Refer to recipe or package directions for oven temperature and baking time.*

Use BAKE for baking on one or two racks. Most items are baked on rack position 3 (center rack in oven).

Some foods are best when other rack positions are used. Refer to the chart below for foods that should be baked using other rack positions.

FOOD ITEM	OVEN TEMP	RACK POSITION	TIME
Angel Food Cake Mix	350° F	1	37 to 47 minutes
Cake Mix 8" round(s) 9" round(s)	350° F 350° F	3 or 2 and 5 3 or 2 and 5	32 to 36 minutes 28 to 31 minutes
Cakes, Specialty Pound cakes	350° F	2	48 to 58 minutes
Cookies Drop	375° F	3 or 1 and 4	8 to 10 minutes
Pizza Scratch Frozen Pre-baked crust Refrigerator	425° F 375° F 425° F 400° F	3 3 3 3	20 to 25 minutes 18 to 25 minutes 12 to 20 minutes 18 to 22 minutes
Pudding Bread pudding Rice pudding	350° F 325° F	2 2	50 to 60 minutes 40 to 50 minutes

* This chart is a guide. Follow recipe or package.

Convection Mode Operation

To Set the Convection mode:

1. For double ovens, select upper or lower oven.

2. Select **CONVECTION**.

The temperature is automatically set at 325°F.

Message scrolls in display:

*SELECT CONVECTION TEMPERATURE
THEN TOUCH START*

3. To change the temperature:

To change the temperature from 325°F, select another temperature immediately before starting.

4. Select **START**.

The temperature display alternates between the set temperature and the actual temperature, beginning with 100°F.

The oven beeps once when the oven is preheated. **PREHEAT** no longer appears the display.

5. To end this mode, select **OVEN OFF**.

- Set Timer 1 or 2 as a reminder to check doneness of the food at minimum time.
- Multiple-rack cooking and baking can be done in this mode. For example, cookies can be baked on all six racks.
- Use low-sided, uncovered pans, such as a jelly roll pan or cookie sheets with 1 or 2 sides.
- Shiny aluminum pans are best, unless otherwise specified.
- Dark finish metal pans and heatproof glass or ceramic bakeware may require oven temperature to be reduced or the time shortened.
- Foods cooking in less than 15 minutes require the same time as in bake mode.
- Cookies may take a few minutes longer when multi-rack convection baking. Place baking sheets directly under each other on the oven racks to enable optimum heat circulation.
- Foods taking 30 minutes or more to cook will have a 10 to 15 percent time savings.
- For foods taking 30 minutes or more to cook, check doneness 3 to 7 minutes sooner than the minimum time.
- Items such as angel food cake, popovers and soufflés will have higher volume when baked in this mode.

Convection mode tips:

- Preheat when using the convection mode.
- For a quick recipe conversion, reduce the oven temperature 25° from the bake setting.

Convection Recommendations

FOOD ITEM	OVEN TEMPERATURE	RACK	TIME*
Cakes, mix or scratch: Angel Food Layers (8" or 9") Rectangle (9 x 13) Cupcakes	325°F 325°F 325°F 325°F	1 2 and 5 3 1, 3, and 5	38 to 48 minutes 32 to 35 minutes 31 to 34 minutes 17 to 20 minutes
Biscuits: Scratch or Refrigerator	425°F	3	10 to 12 minutes
Cookies: Drop or Sliced	350°F	1, 3 and 5	8 to 10 minutes
Cream puffs	375°F	3	20 to 30 minutes
Meringues	325°F	2	20 minutes
Souffles	350°F	3	35 to 40 minutes

* This chart is a guide. Follow recipe or package directions.

Convection Bake Mode Operation

To set the Convection Bake mode:

- For double ovens, select upper or lower oven.
- Select **CONVECTION BAKE**.
The temperature is automatically set at 325°F.
Message scrolls in display:
*SELECT CONVECTION BAKE TEMPERATURE
THEN TOUCH START*
- To change the temperature:
To change the temperature from 325°F, select another temperature immediately before starting.
- Select **START**.
The temperature display alternates between the set temperature and the actual temperature, beginning with 100°F. The actual temperature counts up in 5°F increments.
The oven is preheated when the beep signals once. **PREHEAT** disappears from the display.
- To end this mode, select **OVEN OFF**.

Convection Bake Tips

- This mode may be used for breads, pastries and pies to take advantage of the bottom heat, yielding a better crust on baked items.
- Use the conventional cooking time given in the recipe.
- Most recipes are baked on rack positions 1 or 2 to take advantage of the bottom heat.
- For a quick recipe conversion, reduce the oven temperature by 25°F from the recommended conventional temperature.

Convection Bake Recommendations

FOOD ITEM	RACK	OVEN TEMPERATURE	TIME*
Breads-Yeast: Bread Dinner rolls Sweet rolls Frozen dough	2 2 or 3 2 or 3 1 or 2	325°F 375°F 350°F 375°F	25 to 35 minutes 15 to 20 minutes 20 to 25 minutes 25 to 35 minutes
Pizza: Frozen, self-rising crust	3	375°F	18 to 25 minutes
Pies: 2 Crust fruit, scratch or frozen Pumpkin, scratch or frozen Meringue toppings Nut pies	1 2 2 2 2 1	350°F 375°F 325°F 375°F 325°F 325°F	45 to 60 minutes 60 minutes 50 to 60 minutes 55 to 60 minutes 15 to 20 minutes 40 to 50 minutes
Pastry Crust: Scratch Graham cracker Refrigerator Frozen	2 2 2 2	400°F 350°F 425°F Follow directions	15 to 20 minutes 8 to 10 minutes 10 to 15 minutes
Puff Pastries: Frozen or scratch Turnovers Strudel	1 1 1	375°F 375°F 325°F	20 to 25 minutes 20 to 25 minutes 35 to 40 minutes

* This chart is a guide. Follow recipe or package directions.

Roast Mode Operation

To set Roast mode:

1. For double ovens, select upper or lower oven.
2. Select **ROAST**.

The temperature is automatically set at 350°F.

Message scrolls in display:

*SELECT ROAST TEMPERATURE
THEN TOUCH START*

3. To change the temperature from 350°F, use number pads to select another temperature.
4. Select **START**.

The temperature display alternates between the set temperature and the actual temperature, beginning with 100°F. The actual temperature counts up in 5°F increments.

The oven is preheated when the beep signals once. **PREHEAT** disappears from the display.

5. To end this mode, select **OVEN OFF**.

Roast Mode Tips

- Use Roast mode for conventional open roasting when drippings are desired.
- Roast mode is excellent for less tender meats or poultry when meat is braised and a covered dish is used.
- Use a high-sided roasting pan or cover dish with a lid or foil.
- This may be used to roast meats, poultry and vegetables, which would normally be covered or cooked in a high-sided open roaster.
- Add liquids, such as water, juice, wine, bouillon or stock for flavor and moisture.
- Roasting bags are suitable to use in this mode.
- When roasting whole chickens or turkey, tuck wings behind back and loosely tie legs with kitchen string.

Roasting Recommendations

MEAT AND POULTRY IN COVERED PAN	OVEN TEMPERATURE	RACK LEVEL	COOK TIME	END TEMP
Beef: Pot roast, 3-4 pounds	350°F	1	40 to 60 minutes per pound	170°F
Beef brisket	350°F	2	50 to 60 minutes per pound	170°F
Beef chuck	350°F	1	45 to 55 minutes per pound	170°F
Meatloaf	350°F	3	60 to 90 minutes total time	170°F
Poultry: Chicken, whole or halves	375°F	1	18 to 21 minutes per pound	180°F
Chicken, pieces	375°F	1	Total time 60 minutes	180°F
Turkey, whole	325°F	2	11 to 15 minutes per pound	180°F
Pork: Shoulder	325°F	1	35 to 40 minutes per pound	170°F
Smoked ham, half	325°F	1	2 to 3 hours total	160°F

Convection Roast Mode and Probe Operation

(Upper or Single Oven only)

Use the oven meat probe to take the guesswork out of roasting meats. The meat probe allows you to prepare perfectly roasted meats and poultry by roasting to a specific internal temperature. It is easy to roast meats to an exact temperature for medium rare, medium, medium well or well done. Refer to the Convection Roast Recommendations for “end” temperatures for different meats and poultry.

- Results will yield a drier, crisper exterior that seals in the interior juices with few pan drippings.
- Use Convection Roast when roasting tender cuts of meat or poultry.
- Roast in a low-sided, uncovered pan. Place meat on a flat or V-shaped roasting rack.
- Do not reduce recommended roasting temperature.
- Insert tip of probe into the center of thickest section, avoiding bone and fat.
- Do not cover meat or use cooking bags.
- The probe temperature range is 100°F - 200°F. The default temperature is 160°F.

To set the Convection Roast and Probe mode:

You Will See

- Prepare meat and insert the probe into the thickest section. Avoid bone, gristle and fat.

- For double ovens, select **UPPER** or **LOWER OVEN**.
Message scrolls in display. →

Touch
**UPPER
OVEN**



UPPER

UPPER (LOWER) OVEN SELECTED - TOUCH MODE

- Place roasting pan on oven rack and push the plug into the oven probe receptacle.



UPPER



2:57

- Select **CONVECTION ROAST**.
The temperature is automatically set at 325°F.
To change the oven temperature:
To change the temperature from 325°F, use the number pads to select another temperature .

Touch
**CONVECTION
ROAST**

Touch
3 5 0



350°

UPPER



2:57

*SELECT CONVECTION TEMPERATURE
THEN TOUCH PROBE*

- Select **PROBE**
To change the Probe temperature from 160°F (71°C), use the number pads to select another temperature.
Message scrolls in display. →

Touch
PROBE

Touch
1 4 5

745°

UPPER
PREHEAT



2:57

*SELECT PROBE TEMPERATURE
THEN TOUCH START*

- Select **START**.
The temperature display alternates between the set Probe temperature and the actual meat/poultry temperature, increasing in 5°F increments starting with 100°F.
Touch **CONVECTION ROAST** to view the set oven temperature. The display returns to the probe temperature after 5 seconds of inactivity.

Touch
START



100° / 745°

UPPER



2:57

CONVECT ROAST

Convection Roast Mode and Probe Operation

You Will See

7. To change the Convection Roast Temperature after the mode has started, touch **CONVECTION ROAST** twice.

Touch
**CONVECTION
ROAST**



Use the number pads to select new temperature.

Touch
4
0
0

Touch **Start**

Touch
START

8. To change the Probe Temperature after the mode has started, Touch **PROBE**.

Touch
PROBE



Use the number pads to select new temperature.

Touch
1
2
5

Touch **START**.

Touch
START

9. The oven beeps 3 times when the meat/poultry item probe temperature is reached. The display reads **End** and the oven elements turn off.



Message scrolls in display. →

COOKING COMPLETED -- REMOVE FOOD

Convection Roast Tips

- When roasting whole chickens or turkey, tuck wings behind back and loosely tie legs with kitchen string.
- The broil pan with the grid can be used in this mode.
- Double-check the internal temperature of meat or poultry by inserting probe into another position.
- After removing the meat item from the oven, cover loosely with foil for 10 to 15 minutes before carving.
- While covered, small roast temperatures may increase 5°F and large roast increase 10°F.
- Roasting large cuts of meat and poultry generally takes 10 to 20 percent less cooking time. Check doneness early.

Convection Roast Recommendations

MEAT AND POULTRY UNCOVERED PAN	OVEN TEMPERATURE	RACK	COOK TIME	PROBE TEMP	DONENESS	CARVING TEMP
Beef: Standing rib 3 to 6 lbs.	325°F	2	<u>Minutes Per lb.</u> 28 to 32	135°F 150°F 160°F	Med Rare Med Well	145°F 160°F 170°F
Boneless rib 1 to 4 lbs.	325°F	2	30 to 33	135°F 150°F 160°F	Med Rare Med Well	145°F 160°F 170°F
Sirloin, boneless Rump, eye 3 to 6 lbs.	325°F	2	30 to 33	135°F 150°F 160°F	Med Rare Med Well	145°F 160°F 170°F
Tri-tip Tenderloin 1-1/2 to 3 lbs	425°F	2	<u>Total Time</u> 30 to 40 min. 35 to 45 min.	135°F 150°F 160°F	Med Rare Med Well	145°F 160°F 170°F
Chicken: 3 to 5 lbs. Unstuffed Stuffed*	375°F 375°F	3 3	<u>Minutes Per lb.</u> 18 to 21 18 to 21	180°F 180°F	Thigh Thigh	180°F 180°F
Pieces	375°F	3	60 minutes	180°F	Thigh	180°F
Cornish Game Hens	350°F	2	<u>Total Time</u> 60 to 90 minutes	180°F	Breast and Thigh	180°F
Meatloaf 1 to 2 lbs.	350°F	2	<u>Total Time</u> 60 to 75 minutes	170°F	Well	170°F
Lamb: Leg 4 to 8 lbs. Rack of lamb 1 to 3 lbs.	350°F 350°F	1 1	<u>Minutes Per lb.</u> 24 to 30 30 to 35	135°F 135°F	Med Rare Med Rare	145°F 145°F
Pork: Loin 4 to 6 lbs. 3 to 5 lbs.	350°F 350°F	2 2	<u>Minutes Per lb.</u> 32 to 35 32 to 35	150°F 150°F	Med Med	160°F 160°F
Turkey: Whole, 8 to 15 lbs. Unstuffed Stuffed* Whole 16 to 24 lbs. Unstuffed Stuffed Breast, with bone 5 to 7 lbs.	325°F 325°F 325°F 325°F 325°F	2 2 1 1 2	<u>Minutes Per lb.</u> 9 to 12 10 to 15 7 to 11 10 to 12 16 to 21	180°F 180°F 180°F 180°F 170°F	Thigh Thigh Thigh Thigh Breast	180°F 180°F 180°F 180°F 170°F
Veal: Loin (bone in) 2 to 4 lbs.	325°F	2	<u>Minutes Per lb.</u> 32 to 34	150°F	Med	160°F

* The minimum safe temperature for stuffing in poultry is 165°F.

Broil and Convection Broil Mode Operation

- Do not Preheat for Broil or Convection Broil.
- Broil with the door closed. The control panel will be damaged if door is open during broiling.
- Always use the broil pan packaged with your oven.
- Use Timer to signal when to turn food over.
- Use Broil when broiling meats, fish or poultry pieces up to 1-1/4" thick.
- Use Convection Broil when broiling meats or poultry over 1-1/4" thick.

To set the Broil and Convection Broil modes:

1. For double ovens, select upper or lower oven.

2. Select **BROIL** or **CONVECTION BROIL**.

The temperature is automatically set at HI (550°F/288°C).

Touch
BROIL
or
**CONVECTION
BROIL**

UPPER

550°



3:29

Message scrolls in display. →

*BROIL HI - TOUCH BROIL FOR OTHER LEVELS
THEN TOUCH START*

3. Touch **BROIL** or **CONVECTION BROIL** to toggle from Broil High, Broil Medium and Broil Low temperature levels.

Select desired level

Message scrolls in display. →

Touch
BROIL
or
Touch
**CONVECTION
BROIL**

UPPER

500°



BROIL MEDIUM SELECTED

4. Select **START**.

Touch
START

UPPER

500°

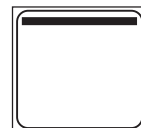

BROIL

5. To end this mode, select **OVEN OFF**.

Broil and Convection Broil Tips

- Place rack at the rack level needed before turning on the oven.
- Start broiling with a cool oven and broiler pan.
- Brush fish and lean cuts of meat with vegetable oil before broiling to prevent sticking.
- Start fish with skin side up.
- Start poultry with skin side down.
- Turn food once halfway through the total cooking time. Thicker cuts of meat or poultry can be turned more often.
- Never use heatproof glass (Pyrex®) or pottery; they cannot tolerate the high temperatures.
- Clean broil pan and grid after each use.
- Do not allow grease and fat to accumulate and remain in pan.
- Do not use other pans for broiling, such as cookie sheets, cake pans, half-sheet pans, jelly roll pans or disposable aluminum pans.

Utensils:

- Slotted top grid on broiler pan lets fat drip away from the upper heating element; this reduces spattering and smoking.
- When top browning casseroles or toasting bread, use only metal or glass-ceramic (Pyroceram®) such as Corningware® bakeware.



CAUTION!

When broiling, open the door carefully. There may be an accumulation of steam and smoke. Do not place the hot broiler pan on the open oven door.

Broil Recommendations

FOOD ITEM and THICKNESS		RACK POSITION	BROIL SETTING	BROIL TOTAL TIME
Beef:	Ground, patties, 3/4" to 1"	6	HI - 550°F	Well - 10 to 15 min.
	Steaks, 3/4 to 1-1/4"	6	HI - 550°F	Med Rare - 8 to 12 min. Med - 9 to 13 min. Well - 10 to 14 min.
Bread:	Garlic bread, 1/2" slices	6	HI - 550°F	2-1/2 to 4 minutes
	3/4" to 1" slices	6	HI - 550°F	4 to 6 minutes
Fish:	Fillets or steaks, 1/2" to 1"	5 or 6	Medium - 500°F	Flakes - 8 to 12 minutes (1/2" thickness does not need to be turned after half of broil time)
Lamb:	Chops, 1/2" to 1"	6	HI - 550°F	Med - 12 to 17 minutes Well - 15 to 20 minutes
Pork:	Chops, 1/2" to 1"	6	Medium - 500°F	Well - 18 to 25 minutes
	Smoked, ham steak, 1/2"	6	HI - 550°F	Well - 7 to 11 minutes
	Ham steak, 1"	6	HI - 550°F	Well - 12 to 15 minutes
Poultry:	Chicken, pieces	4	Low - 450°F	30 to 45 minutes
Sausage:	Hot dogs, whole	6	HI - 550°F	4 to 5 minutes
Veal:	Chop, 1"	6	HI - 550°F	Well - 12 to 16 minutes

Convection Broil Recommendations

FOOD ITEM and THICKNESS		RACK POSITION	BROIL SETTING	BROIL TOTAL TIME
Beef Roast:	Flat, 1-1/2" or more	4	Med - 500°F	Med Rare - 18 to 22 min. Med - 22 to 28 min. Well - 26 to 32 min.
Steak:	1-1/4" or more	5	HI	
Lamb:	Chops, 1-1/4" or more	5	HI	Med - 21 to 27 minutes Well - 27 to 33 minutes
Pork:	Chops or tenderloin, 1-1/4" or more	5	Med - 500°F	Well - 18 to 25 minutes
Poultry:	Chicken, quarters	4	Low - 450°F	30 to 45 minutes
	Turkey, pieces	4	Low - 450°F	30 to 50 minutes
Sausages:	Fresh, uncooked	5	HI	Well - 6 to 8 minutes

Warm Mode Operation

The Warm mode will keep hot, cooked foods at serving temperature. Always start with hot food. DO NOT use this mode to heat cold food other than for crisping crackers, chips and dry cereal. Serving dishes, plates and cups may be kept warm with this mode. Do not use the WARM mode to cook food.

The WARM mode oven temperatures range from 140°F for LOW up to 210°F for HIGH.

- Food should be at serving temperature (above 140°F) before being placed in the oven.
- Food may be kept hot in its cooking container or transferred to a heat-safe serving dish.
- Aluminum foil may be used to cover food.
- Use only heat-safe dishes.
- Use a portable meat thermometer to check internal temperatures. Refer to Page 46 for Food Safety Guidelines.
- CAUTION: Plastic containers or plastic wrap can melt if in direct contact with the oven walls or oven bottom.
- When keeping cooked food warm, allow time for the oven to preheat before placing the item in the oven. The oven temperatures are 140°F = Low, 170°F = Med, 210°F = High

To set Warm mode:

1. For double ovens, select upper or lower oven.
2. Select **WARM**.
The oven temperature is automatically set at 170°F or MED.
Message scrolls in display:
SELECT WARM TEMPERATURE - THEN TOUCH START
3. To change the temperature from 170°F, use the number pads to select another temperature.
4. Select **START**.
The temperature display alternates between the set temperature and the actual temperature, beginning with 100°F. The actual temperature counts up in 5° increments.
5. To end this mode, select **OVEN OFF**.

Proof Mode Operation

- Proofing is the rising of yeast dough.
- Place food in oven before selecting this mode.
- The proofing temperature is preset at 100°F.
- Use any rack level that accommodates the size of the bowl or pan.
- Loosely cover the bowl or pan.
- Keep the oven door closed and use the oven light to check the rising of the dough.
- Use either **TIMER 1** or **TIMER 2** as a reminder if desired.

To set the Proof mode:

1. For double ovens, select upper or lower oven.
2. Select **PROOF**.
Message scrolls in display:
PROOF MODE SELECTED TOUCH START
3. Select **START**.
The oven is preheated when the beep signals once. **PREHEAT** disappears from the display.
4. To end this mode, select **OVEN OFF**.

Dehydrate Mode Operation

- It is not necessary to preheat when using the dehydrate mode.
- Use drying screens (not supplied with oven).
- Multiple racks can be used simultaneously.
- Place food in oven before selecting the mode.
- The dehydrating temperature is preset at 140°F.
- Some foods require as much as 14 to 15 hours of time to fully dehydrate.
- This mode is suitable for a variety of fruits, vegetables, and herbs.

To set the Dehydrate mode:

1. For double ovens, select upper or lower oven.
2. Select **DEHYDRATE**.
Message scrolls in display:
DEHYDRATE MODE SELECTED - TOUCH START
3. Select **START**.
The oven is preheated when the beep signals once. **PREHEAT** no longer appears in the display.
4. To end this mode, select **OVEN OFF**.

Timed Cook Operation

- In double oven models, each oven can be set to operate on a separate timed mode.
- Be sure that the time of day clock is displaying the correct time.
- The timed mode automatically turns off the oven at the end of the cook time.
- The Timed Cook feature delays the cooking time. The oven is set to cook for a period of time. Place food in the oven; Cooking begins and ends at the specified time. The oven turns off automatically.
- The Timed Cook feature is available for the following oven modes: Bake, Convection and Convection Bake.
- To maintain food safety, do not use the timed cook feature with the roast or convection roast modes.
- Delayed cooking is not recommend for foods that need to rise after mixing, such as soufflés, quick breads, yeast breads, cakes, etc.
- Remove food from the oven immediately after cooking time has ended to prevent overcooking. Food left in the oven will continue to cook because of the residual heat in the oven.
- Microwave mode cannot be used while oven is in a timed cook operation.
- Microwave mode cannot be programmed into a timed cook operation.

To set Timed Mode:

Example shown has time of day set at 3:00.

1. For double ovens, select upper or lower oven.

2. Select **BAKE, CONVECTION** or **CONVECTION BAKE**.

Touch
BAKE
or
CONVECTION
or
CONVECTION BAKE

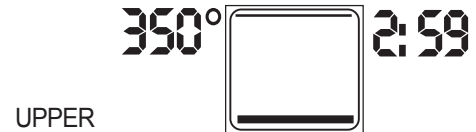

*SELECT BAKE TEMPERATURE
THEY TOUCH START*

Message scrolls in display. →

3. Immediately before starting, select the number of hours and minutes the oven will be on. For example, 3, 0 is 30 minutes

Touch
COOK TIME
3 0



4. Select **START**.
The oven turns on and heats to the temperature selected for the number of hours and minutes needed. The clock automatically calculates the time of day the mode will stop and the oven will turn off. The example shows that it will stop at 3:30 after cooking for 30 minutes.

Touch
START

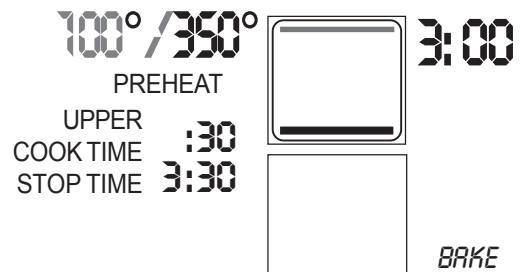

Timed Cook Operation (continued)

To delay the Start of the timed mode:

Example shown has time of day set at 3:00

- Follow steps 1, 2 and 3 on previous page. After the number of hours/minutes are selected for the food to cook, select the Stop Time.

Touch
STOP TIME

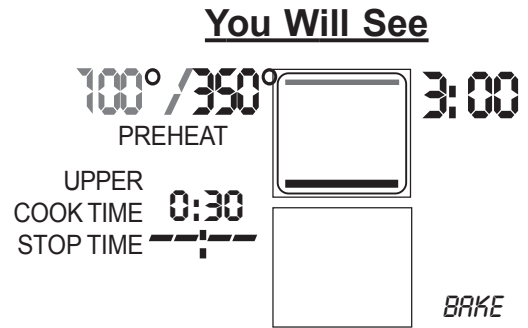

- Select the time of day the oven will stop cooking or turn off. This example, shows that the oven will stop at 4:30 and cook for 30 minutes.

Touch
4 3 0

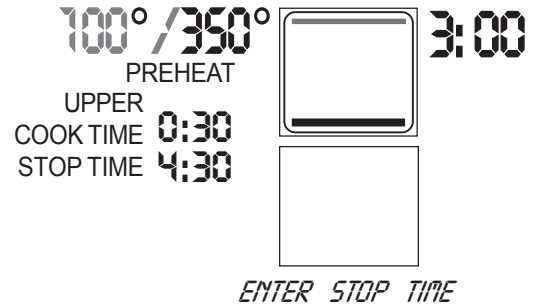

Message scrolls in display. →

- Select **START**.
The oven turns on and heats to the temperature selected for the number of hours and minutes needed.
The clock automatically calculates the time of day the mode starts and stops.

Touch
START

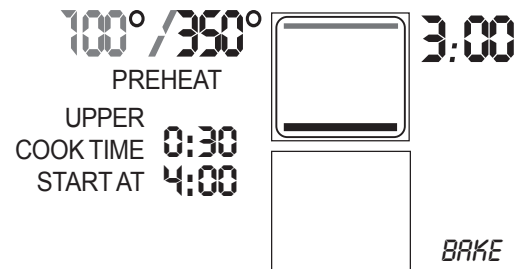

- The microwave mode cannot be used with delayed TIMED COOK.
- When a delayed TIMED COOK program has been set the microwave mode cannot be used until the delay program has been completed or canceled.

Food Safety Guidelines

Food Serving Temperature Guidelines from FSIS (USDA Food Safety & Inspection Service)

<p>140°F</p> <ul style="list-style-type: none"> Ham, precooked (to reheat) <p>145°F</p> <ul style="list-style-type: none"> Fresh Beef, Veal, Lamb (medium rare) <p>160°F</p> <ul style="list-style-type: none"> Ground Meat & Meat Mixtures (Beef, Pork, Veal, Lamb) Fresh Beef, Veal, Lamb (medium) Fresh Pork (medium) Fresh Ham (raw) Egg Dishes 	<p>165°F</p> <ul style="list-style-type: none"> Ground Meat & Meat Mixtures (Turkey, Chicken) Stuffing (cooked alone or in bird) Leftovers & Casseroles <p>170°F</p> <ul style="list-style-type: none"> Fresh Beef, Veal, Lamb (well done) Poultry breasts Fresh Pork (well done) <p>180°F</p> <ul style="list-style-type: none"> Chicken and Turkey, (whole) Poultry (thighs and wings) Duck and Goose
--	--

NOTE: Eggs (alone, not used in a recipe) cook until yolk & white are firm.

Setting the Sabbath Mode

- This mode is Sabbath compliant for religious faiths with “no work” requirements on the Sabbath.
- The BAKE mode is the only cooking mode that can be used with Sabbath mode.
- The Sabbath Mode can be set for one oven or both ovens. To set for both ovens at the same time, turn both ovens on. Then touch **TIMER 1 OFF** pad and hold for 5 seconds.
- The Sabbath Mode remains active until oven(s) are manually turned off.

To set the Sabbath mode:

1. Touch **OVEN OFF** to cancel all modes.
2. For double ovens, select upper or lower oven.

Message scrolls in display. →

You Will See

UPPER OVEN SELECTED

3. Select **BAKE** mode and temperature.
Use number pads to change the temperature if necessary. See Page 34.

Touch
BAKE



Message scrolls in display. →

4. Select **START**.

Touch
START



5. Select on or off status for the lights. To keep lights off, do not touch.
 - Lights will remain on or off as set at this time until the Sabbath mode is cancelled.

Touch
LIGHTS

6. To activate the Sabbath mode, touch and hold **TIMER OFF** pad for 5 seconds.
 - The word “**SAB**” is displayed.
 - “**Preheat**” is displayed until the oven reaches temperature.
 - All pads, except the oven OFF, will be inactive. No beep is generated.
 - When the red heating symbol in the display is illuminated, the bake element is on. Opening the door at this point will not cause the heating element to be activated, since it will already be on.
 - Oven will remain “on” indefinitely until cancelled.

Touch
TIMER 1 OFF

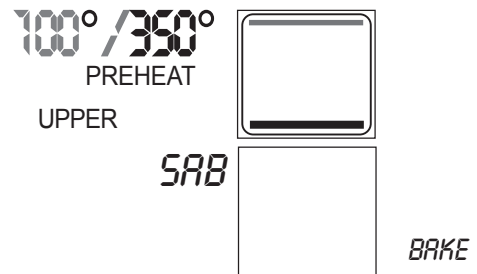

7. To Cancel or Stop the Sabbath mode:
 - Touch **OVEN OFF**.
 - Turn off the light if it was set to stay on in Step 5.

Tips for Self Cleaning the Oven

Your new oven features pyrolytic self cleaning. When set into the Clean mode, the oven reaches a high temperature that burns off the food soil.

- As a safety feature, the oven door locks during Self Clean to protect you from very high temperatures. Do not try to open the oven during Self Clean mode.
- Only one oven can be set to self clean at a time. The second oven cannot be used while one is self cleaning.
- It is common to see smoke and/or an occasional flame-up during the Clean cycle, depending on the content and amount of soil remaining in the oven. If a flame persists, turn off the oven and allow it to cool before opening the door to wipe up the excessive food soil.
- The oven light will not turn on when the oven is set for a clean cycle.
- Do not use commercial oven cleaners as they may damage finish or parts.

NOTE: Due to the high temperatures used for self cleaning, fine lines or surface roughness may develop in oven cavity. This is a common condition and does not affect either the cooking or the cleaning performance of the oven.

IMPORTANT: Be sure to let the inside window glass in the oven door cool completely before wiping up any ash left from the clean cycle.

Before You Self Clean

1. Hand clean the oven door edge, window, oven front frame and oven cavity edges (shaded areas below). They do not get hot enough during the cleaning cycle for soil to burn away. Use a soapy sponge, plastic scrubber or an S.O.S.® pad. **DO NOT RUB THE GASKET.**
2. Wipe up large overspills and grease with paper towels.
3. Remove broiler pan, all utensils and bakeware.
4. **Remove oven racks.** If the oven racks are left in the oven during a self cleaning cycle, they will permanently lose their shiny finish and change to a dull dark finish. See Oven Cleaning for proper care, Page 51.
NOTE: The Extendable Rack must be removed before a self clean. The rack may not be usable if it is left in during self clean.
5. Be sure the light is turned off on the control panel and the bulb and glass cover are in place, see Page 53.
6. Heat and odors are normal during the Self Clean cycle. Keep the kitchen well ventilated.

After Self Clean

- At the end of the Clean cycle, gray ash remains inside the oven. The amount of ash depends on how heavily soiled the oven was before it was cleaned. It is easily removed, when the oven is cold, using a damp sponge or cloth. If the racks do not slide easily after being cleaned, lightly rub rack side rails with vegetable oil. Wipe off excess.

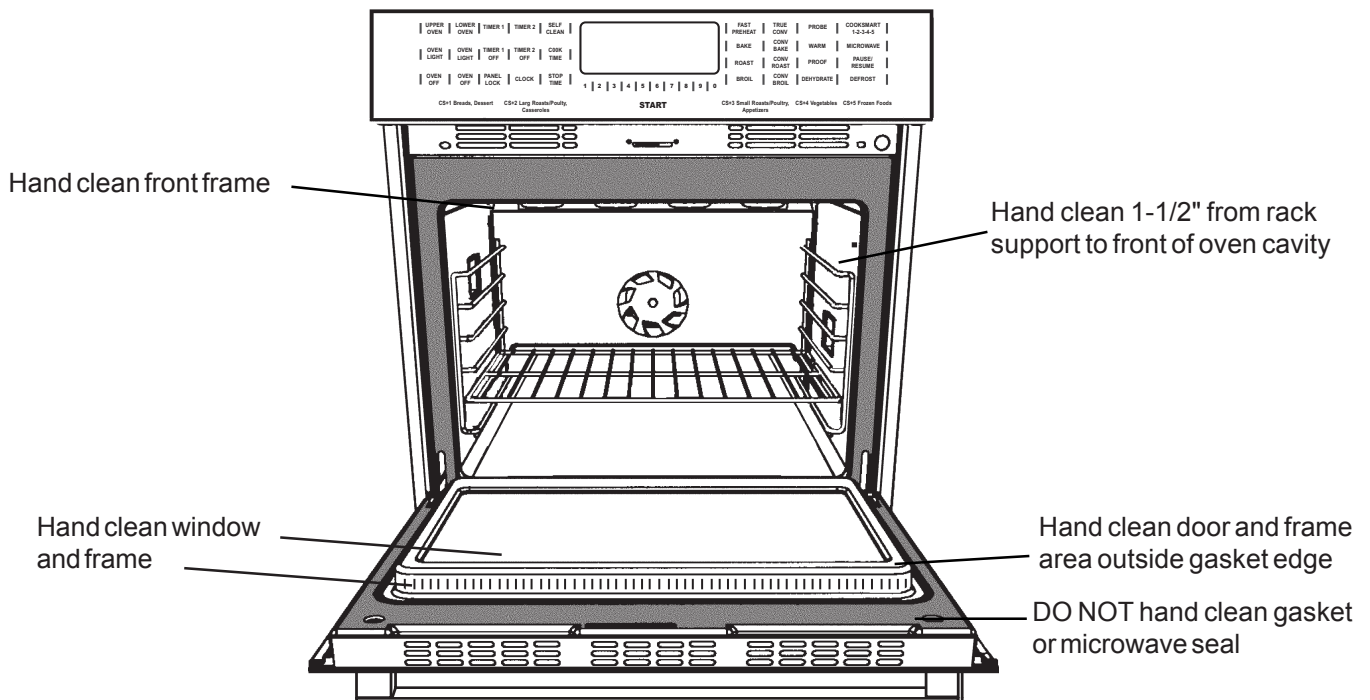

Self Clean Mode Operation

- Self-Clean only one oven at a time.
- The oven light does not operate during this mode.
- Be sure that the time of day clock is displaying the correct time.
- Three hours is the preset length of cleaning.
- The mode stops automatically at the end of the clean hours.

To set the Self Clean mode to start now:

1. For double ovens, select upper or lower oven.

2. Select **SELF CLEAN**.

Example shows clock set at 5:00.

The number of clean hours (3:00) is displayed automatically.

Message scrolls in display. →

Touch
**SELF
CLEAN**

CLN
UPPER
COOK TIME
3:00



5:00

*REMOVE ALL RACKS FROM OVEN
THEN ENTER SELF CLEAN TIME
THEN TOUCH START*

3. To change the setting:

To change the setting from 3 hours, select either 2 hours for light soil or 4 hours for heavy soil.

Message scrolls in display. →

Touch
4 0 0

CLN
UPPER
COOK TIME
3:00



5:00

ENTER SELF CLEAN TIME

4. Select **START**.

The door locks automatically. When the lock symbol is displayed, the door cannot be opened. Confirm that the door locks and will not open at the start of the self clean mode. If door does not lock, press OFF and do not self clean; phone (800) 735-4328 for service (see Page 54 for obtaining service.) If the door is in the open position when this mode is selected, the display will flash the word "dor". This is a reminder that the door must be closed before the Self Clean mode can be set.

Touch
START

 CLN
UPPER
COOK TIME
3:00
STOP TIME
9:00



5:00
SELF CLEAN

REGARDING PET BIRDS

Birds have very sensitive respiratory systems. Keep pet birds out of the kitchen or other rooms where kitchen fumes could reach them. During Self Clean mode, fumes that may be harmful to birds are released. Other kitchen fumes, such as from overheating margarines and cooking oils, may also be harmful.

Self Clean Mode Operation (continued)

To delay the start of the Self Clean mode:

1. For double ovens, select upper or lower oven.
2. Select **SELF CLEAN**.

The number of clean hours (3:00) is displayed automatically. Use the number pads to change the time if necessary. Use 2 hours for light soil and 4 hours for heavy soil.

Message scrolls in display. →

You Will See

Touch
**SELF
CLEAN**

CLN
UPPER
COOK TIME 3:00



5:00

*REMOVE ALL RACKS FROM OVEN
THEN ENTER SELF CLEAN TIME
THEN TOUCH START*

3. Select **STOP TIME**.

When the words **STOP TIME** flash, enter the time of day. Oven will display the time when the clean cycle will stop.

Message scrolls in display. →

Touch
**STOP
TIME**

Touch
1 1 0 0

CLN
UPPER
COOK TIME 3:00

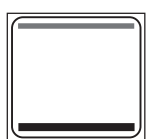

5:00

STOP TIME 8:00

ENTER STOP TIME

4. Select **START**.

The oven calculates the appropriate start time so that the mode is complete at the stop time.

Touch
START

 CLN

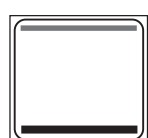

5:00

UPPER
COOK TIME 3:00

START AT 8:00



SELF CLEAN

5. To cancel or stop the mode after the "lock" symbol is displayed, select **OVEN OFF**. When the lock symbol is no longer present, the door can be opened.

Oven Finishes / Cleaning Method

The entire oven **except the oven door gasket** can be safely cleaned with a soapy sponge, rinsed and dried. Do not rub or clean the oven gasket

If stubborn soil remains, follow the recommended cleaning methods below.

- Always use the mildest cleaner that will do the job.
- Rub metal finishes in the direction of the grain.
- Use clean, soft cloths, sponges or paper towels.
- Rinse thoroughly with a minimum of water so it does not drip into door slots.
- Dry to avoid water marks.

The cleaners recommended below indicate a type and do not constitute an endorsement.

Use all products according to package directions.

Refer to oven illustration on Page 6 to identify oven parts.

PART	CLEANING METHOD
Chrome Plated - Oven racks	Wash with hot sudsy water. Rinse thoroughly and dry. Or, gently rub with Soft Scrub [®] , Bon-Ami [®] , Comet [®] , Ajax [®] , Brillo [®] or S.O.S. [®] pads as directed. Easy Off [®] Oven Cleaner (cold oven formula) can be used, but may cause darkening and discoloration. If racks are cleaned in the oven during the self clean mode, they will lose their shiny finish and permanently change to a metallic gray. The Extendable Rack should not be left in oven during self clean or washed in the dishwasher.
Fiberglass Knit - Door seal gasket	DO NOT HAND CLEAN GASKET.
Glass - Control panel - Door front	Spray Windex [®] or Glass Plus [®] onto a cloth first, then wipe to clean. Use Fantastik [®] or Formula 409 [®] to remove grease spatters.
Painted *	Clean with hot sudsy water or apply Fantastik [®] or Formula 409 [®] first to a clean sponge or paper towel and wipe clean. <u>Avoid using powdered cleansers and steel wool pads.</u>
Porcelain - Oven front frame - Oven cavity - Broil pan, grid	Immediately wipe up acid spills like fruit juice, milk and tomatoes with a <u>dry</u> towel. Do not use a moistened sponge/towel on hot porcelain. When cool, clean with hot sudsy water or apply Bon-Ami [®] or Soft Scrub [®] to a damp sponge. Rinse and dry. For stubborn stains, gently use Brillo [®] or S.O.S. [®] pads. It is normal for porcelain to craze (fine lines) with age due to exposure from heat and food soil.
Reflective Glass - Interior door window	Clean with hot sudsy water and sponge or plastic scrubber. Rub stubborn stains with vinegar, Windex [®] , ammonia or Bon-Ami [®] . DO NOT USE HARSH ABRASIVES.
Stainless Steel - Control panel - Door front - Top door vent	Always wipe or rub with grain. Clean with a soapy sponge; rinse and dry. Wipe with Fantastik [®] or Formula 409 [®] sprayed onto a paper towel. Protect and polish with Stainless Steel Magic [®] and a soft cloth. Remove water spots with a cloth dampened with white vinegar. Use Cameo [®] or Barkeeper's Friend [®] to remove heat discoloration.
Probe	Clean probe by hand with detergent and hot water. Rinse and dry. Do not soak or clean in dishwasher.

* Door frame, side trim, control panel trim, oven cooling vents.

Do-It-Yourself Maintenance

Removing the Lower Oven Door

The Upper or Single oven door is not removable.



CAUTION

USE CAUTION WHEN REMOVING THE DOOR. THE DOOR IS VERY HEAVY.

- Make sure oven is cool and power to oven has been turned off before removing the door. Failure to do so could result in electrical shock or burns.
- The oven door is heavy and fragile. Use both hands to remove or replace the door.
- Grasp only the sides of the oven door when removing or replacing it.
- Failure to grasp the oven door firmly and properly could result in personal injury and product damage.
- With the door off, never release the levers and try to close the hinges. Without the weight of the door, the powerful springs will snap the hinges closed with great force.

The lower oven door can be lifted off for your convenience in cleaning hard-to-reach areas inside the oven.

To Remove the Oven Door:

1. Fully open the oven door.
2. Flip the hinge clip toward you (see illustration below).
3. Close the door until it stops (the open hinge clip will hold the door about halfway open).
4. Grasp the door on the sides. The door is heavy and fragile - always use both hands. Lift the door up and out (there will be some spring resistance to overcome). When the front of the door is high enough, you will be able to pull the door straight out.
5. Place the door in a safe and stable location.

To Replace the Oven Door:

1. Hold door on both sides. Insert hinges into hinge slots. The door will be about halfway open.
2. Open door all the way to expose hinge clips. Push hinge clips away from you (toward the oven) until they meet the hinge.
3. Close and open the door slowly to test the installation. It should open and close smoothly and be straight, not crooked.

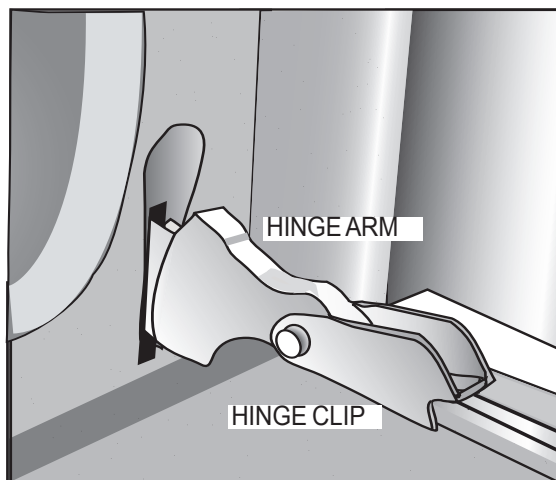

Door Hinge
Close-up View

Do-It-Yourself Maintenance

Replacing the Oven Light

NOTE: The Upper or Single Oven Light must be replaced by a qualified service technician.



CAUTIONS:

To prevent personal injury:

- Before replacing the light bulb, be sure the electric power is turned off at the circuit breaker.
- Halogen bulbs get **HOT INSTANTLY** when turned ON.
- Be sure the oven and light bulb are cool.
- Do not operate the oven unless the light cover is securely in position.



CAUTION: If the light cover is damaged or broken, do not use the oven until properly repaired.

The oven lights have a removable lens cover and a halogen light bulb. The ceramic light socket housing is not removable.

Replace bulb with a 12-Volt, 10-Watt Halogen bulb only.

To replace Halogen Bulb:

1. Turn off circuit breaker.
2. Remove oven racks.
3. Slide the tip of a table knife blade between the fixing clip and the glass lens cover.
5. Gently twist the knife blade to loosen the glass lens cover. Catch lens cover with other hand as it loosens. Set aside.
6. Remove the fixing clip.
7. Remove the bulb by grasping and sliding the bulb straight up until the two prongs have cleared the ceramic holder.
8. Do not touch the glass of the new replacement bulb with your fingers. It will cause the bulb to fail when it first lights. Grasp the replacement bulb with a clean paper towel or facial tissue with the prongs facing down. Place the two prongs in the ceramic holder, pressing gently until the two prongs locate in the ceramic socket.
9. Press down gently to seat the bulb.

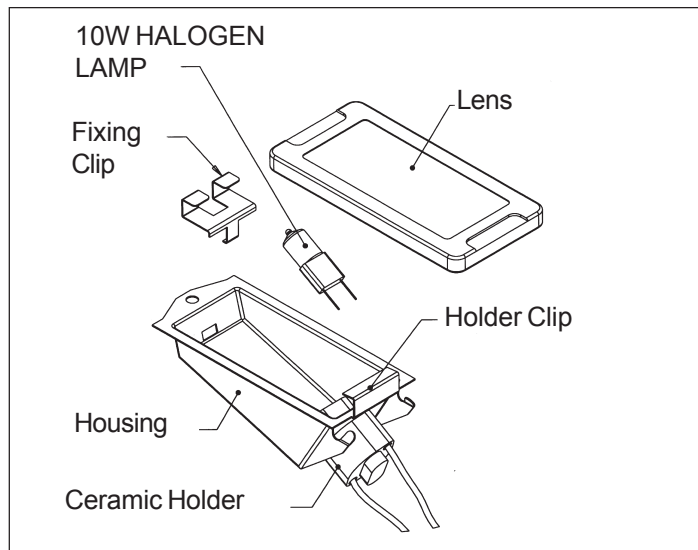

10. Place the fixing clip on the lens cover.
11. Slide the protective lens into the holder clip and push the other end until the fixing clip snaps back into the housing.
12. Turn on circuit breaker.

Changing to the 24-Hour Clock Format

The oven has been preset to a 12- hour clock format.

To change the Time-of-Day Clock to a 24-Hour Clock, follow these steps:

1. Turn off both ovens.
2. Touch **START** and hold the **CLOCK** pad at the same time.
3. 12H appears in the Clock window; release both pads at the same time.
4. Touch **CLOCK** and 24H replaces 12H. This alternates when **CLOCK** is touched.
5. To complete the change, touch **START**.

Do-It-Yourself Maintenance

Fahrenheit to Celsius

The oven has been preset to a Fahrenheit temperature.

To change to Celsius, follow these steps:

1. Turn off ovens.
2. Touch and hold the **START** pad and then the **CONVECTION** pad at the same time for 3 seconds.
3. “**F**” appears in the temperature digits; release both pads at the same time.
4. Touch **CONVECTION**; “**C**” replaces “**F**.” This alternates when **CONVECTION** is touched.
5. To complete the change, touch **START**.

Voltage Change Option

The oven has been preset for 240 VAC. If your residence has been supplied with 208 VAC, the oven voltage can be changed during installation.

1. Turn both ovens off. Touch **OVEN OFF** for each oven.
2. Touch and hold the **START** pad and the **SELF CLEAN** pad at the same time for 3 seconds.
3. “**240**” appears in the display. Release both pads at the same time.
4. Touch the **SELF CLEAN** pad. “**240**” is replaced with “**208**.” This alternates when **SELF CLEAN** is touched.
5. To complete the change, touch **START**.

Calibrating Oven Temperature

The electronic thermostat has been preset to 0°F and accurately maintains its setting. If the browning results are too light or too dark for your preferences, you can raise or lower the setting.

To change calibration of oven temperature for single or upper ovens:

1. Turn off oven(s).
2. For single oven or upper oven, touch and hold the **START** pad and then touch the **BAKE** pad.
3. “**0**” (zero) appears in the temperature digits; release all pads at the same time.
4. Touch **BAKE** and **0** changes in increments of 5 degrees each time it is touched. The maximum adjustment is $\pm 35^\circ\text{F}$.
5. To complete the change, touch **START**.

To change calibration of oven temperature for lower oven on double ovens:

1. Touch the **ROAST** pad.
2. Continue with Steps 3 through 5, as described above.

NOTE: The available temperature range for this oven is 100°F to 550°F. This applies to all conventional cooking modes. A change in the calibration does not affect Dehydrate, Proof or Warm modes.

Beep Volume

The volume of the beeps can be adjusted. Touch and hold the **START** pad followed by the **PROBE** pad for three seconds. Touch **PROBE** pad again to increase or decrease volume, from levels 1 to 3. Touch **START** to set volume selection.

How to Obtain Service

For authorized service or parts information, phone (800) 735-4328.

We want you to remain a satisfied customer. If a problem occurs that cannot be resolved to your satisfaction write to Thermador Customer Support Center, 5551 McFadden Avenue, Huntington Beach CA, 92649 or call: 1-800-735-4328.

Please include the Model Number, Serial Number, Fabrication Date and Date of Original Purchase and Installation.

Solving Baking Problems

With either **BAKE**, **CONVECTION** or **CONVECTION BAKE**, poor results can occur for many reasons. Check the recommendations below for causes of the most common problems. Since the size, shape and material of bakeware directly affect the baking results, the best solution may be to replace old bakeware that have darkened and warped with age and use. Check the Baking Recommendations for the correct rack position and baking time.

BAKING PROBLEM	POSSIBLE CAUSES
Food browns unevenly	<ul style="list-style-type: none"> • Oven not preheated • Aluminum foil on oven rack or oven bottom (not recommended) • Bakeware too large for recipe • Pans touching each other or oven walls
Food too brown on bottom	<ul style="list-style-type: none"> • Oven not preheated • Using glass, dull or darkened metal pans • Incorrect rack position • Pans touching each other or oven walls
Food dry or has shrunk excessively	<ul style="list-style-type: none"> • Oven temperature too high • Baking time too long • Oven door opened frequently • Pan size too large.
Food baking or roasting too slowly	<ul style="list-style-type: none"> • Oven temperature too low • Oven not preheated • Oven door opened frequently • Food too tightly sealed with aluminum foil • Pan size too small
Pie crusts do not brown on bottom or have soggy crust	<ul style="list-style-type: none"> • Baking time not long enough • Using shiny metal pans • Incorrect rack position • Oven temperature is too low
Cakes pale, flat and may not be done inside	<ul style="list-style-type: none"> • Oven temperature too low • Incorrect baking time • Cake tested too soon • Oven door opened too often • Pan size may be too large
Cakes high in middle with crack on top	<ul style="list-style-type: none"> • Baking temperature too high • Baking time too long • Pans touching each other or oven walls • Incorrect rack position • Pan size too small
Pie crust edges too brown	<ul style="list-style-type: none"> • Oven temperature too high • Edges of crust too thin

Solving Operational Problems

Before calling for service, check the following to avoid unnecessary service charges.

PROBLEM OVEN	POTENTIAL CAUSES AND SOLUTIONS
All the numbers touched do not appear in display	The numbers were touched too rapidly. Be sure you remove your finger from the first number pad before touching the next digit.
F followed by 2 digits appears in the display window	Touch OVEN OFF or turn power off at the circuit breaker, wait 3 minutes and turn the oven back on. If condition persists, note the code number and call an authorized service technician.
F-24 or F-25 appears in display window	This is caused by close contact to the control panel for more than 60 seconds, (i.e.; someone leaning against the controls or objects hanging in front of controls). Follow guidelines for "F followed by 2 digits", above.
SAb appears in display window	Oven is in Sabbath mode. To turn off sabbath, touch OVEN OFF .
Cooling fan continues to run after oven is turned off	This is normal. The fan turns off automatically when the electronic components have cooled sufficiently.
Clock and timer do not work	Make sure there is proper electrical power to the oven. See the Clock and Timer sections on Pages 9 and 10.
Oven will not work	Make sure there is proper electrical power to the oven. Check the circuit breaker or fuse box to your house.
Oven light does not work	Replace or reinsert the light bulb if loose or broken. See Page 53. Touching the bulb with your fingers may cause the bulb to burn out quickly. Oven light does not work if Self Clean mode is set. Oven light cannot be turned on or off while sabbath mode is in operation.
Food is overdone or underdone	Try suggestions in "Solving Baking Problems, page 55. Adjust oven thermostat. See Calibrating Oven Temperature in Do-It-Yourself Maintenance, Page 54.
Oven will not self clean	Verify that self clean mode was properly programmed. See "Self Clean Mode Operation, page 49). The oven temperature is too high to set the self clean operation. Allow the oven to cool to room temperature and reset the controls.
Oven door will not unlock	This is normal during and after self clean. Allow the oven to cool below the locking temperature.
Oven is not clean after the clean cycle	Heavily soiled ovens may require a second self clean for a longer period of time. Heavy spillovers should be cleaned before starting the clean cycle. See Before You Self Clean, Page 48.
Oven does not lock in Self Clean mode	Do not run Self Clean. Call for service. See Page 54.
Oven Racks does not glide or extendable rack is difficult to extend. Racks are discolored.	Extendable Rack was left in oven during self clean. Apply a small amount of vegetable oil to the rack support areas to facilitate rack extension and removal. Color change is permanent. To order a replacement Extendable Rack, phone Thermador Customer Support at (800) 735-4328.

Thermador Built-in Oven Warranty

For Models: DM301 and DM302

WHAT IS COVERED

Full One Year Warranty

Covers one year from date of installation, or date of occupancy on a new or previously unoccupied dwelling. Save your dated receipt or other evidence of installation / occupancy date. Thermador® will pay for all repair labor and replacement parts found to be defective due to materials and workmanship. A Factory Authorized Service Agency must provide Service during normal working hours.

Limited Four Year Warranty

Covers the second through fifth years from date of occupancy on a new, previously unoccupied dwelling. Replacements of the magnetron tube if it falls within four years following the expiration of the full warranty.

the warranty period, the new owner continues to be protected until the expiration date of the original purchaser's warranty period.

MANUFACTURER DOES NOT ASSUME, AND SPECIFICALLY DISCLAIMS, ANY RESPONSIBILITY FOR ANY INCIDENTAL, CONSEQUENTIAL, NOMINAL, INDIRECT, "BUSINESS LOSS", OR PUNITIVE DAMAGES. MANUFACTURER SPECIFICALLY DISCLAIMS ANY AND ALL WARRANTIES OR REPRESENTATIONS, EXPRESS OR IMPLIED, INCLUDING WITHOUT LIMITATION FITNESS FOR A PARTICULAR PURPOSE OR WARRANTY OF MERCHANTABILITY. This limited warranty and limitation of damages may be subject to applicable legal restrictions. This warranty gives you certain legal rights, and you may have other legal rights at law which may vary jurisdictionally.

WHAT IS NOT COVERED

1. Service, or damage caused by, an unauthorized person or agency, or use of unauthorized parts.
2. Damage caused by consumer misuse or abuse, or damage caused by any third party's acts or omissions.
3. Damages resulting from accident, alteration, misuse, abuse, shipping, improper installation (including installation not in accordance with local electrical codes or plumbing codes), improper storage of the appliance, and any property damage not due to the direct result of a manufacturer's defect.
4. Damage caused by anything other than normal, noncommercial, household use.
5. Service visits to:
 - Teach you or others how to use the appliance.
 - Correct installation problems. You are solely responsible for providing all electrical wiring and other connecting facilities, proper foundation/flooring, and for any alterations (including cabinetry, walls, floor, shelving, etc.) necessary for installation.
 - Reset circuit breakers or replace home fuses.

SERVICE DATA PLATE

The data plate shows the model and serial number. Refer to the data plate on the appliance when requesting service. The location of the data plate is shown in the picture below.

Data Plate

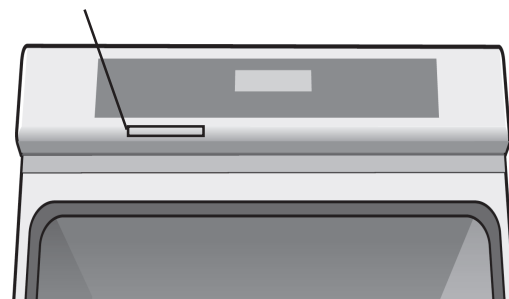

WARRANTY APPLICATIONS

This warranty applies to appliances used in normal family households; it does not cover their use in commercial situations.

This warranty is for products purchased and retained in the 50 states of the U.S.A., the District of Columbia and Canada. The warranty applies even if you should move during the warranty period. Should the appliance be sold by the original purchaser during

Notes:

Thermador[®] | *An American Icon*[™]

5551 McFadden Avenue, Huntington Beach, CA 92649 • 800-735-4328 • www.thermador.com
9000215791 • 5V09WJ • Rev. B • 1/07 © BSH Home Appliances Corporation, 2006 • All rights reserved
Litho in USA