

MODEL WITH BRIDGE ELEMENT / MODELO Y ELEMENTO RADIANTE SUPERIOR DE PUENTE / MODELE AVEC ELEMENT PONT

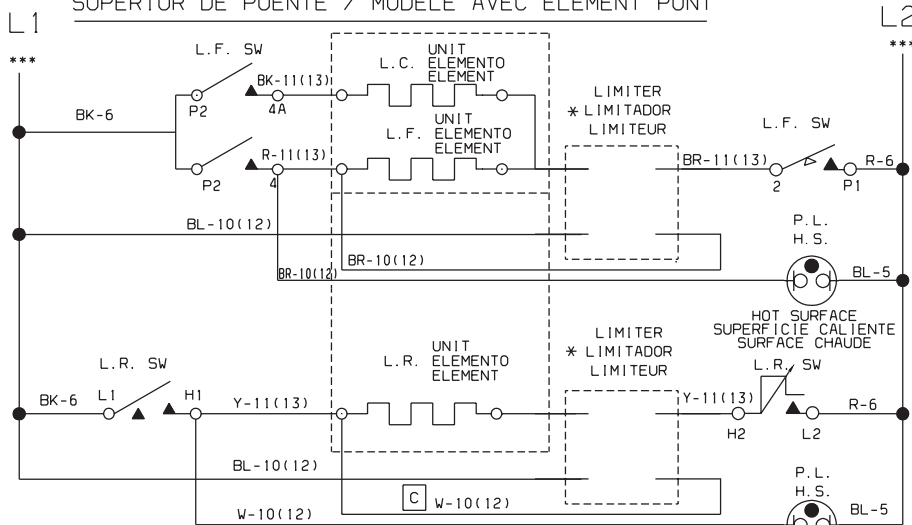

MODEL WITH DOUBLE ELEMENT / MODELO Y ELEMENTO DE DOBLE / MODELE AVEC ELEMENT DOUBLE

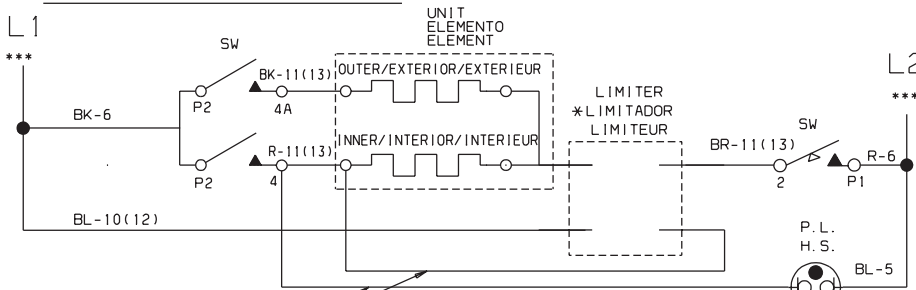

SEE LEGEND / VER LEYENDA / VOIR LEGENDE 3

MODEL WITH REGULAR ELEMENT / MODELO Y ELEMENTO REGULAR E / MODELE AVEC ELEMENT REGULIER

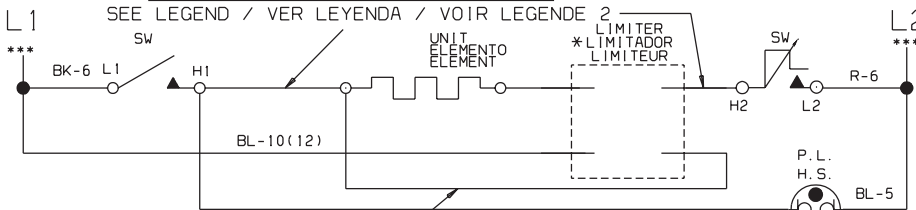

SEE LEGEND / VER LEYENDA / VOIR LEGENDE 3

MODEL WITH WARMING ELEMENT / MODELO Y ELEMENTO DE CALENTADOR / MODELE AVEC ELEMENT RECHAUD

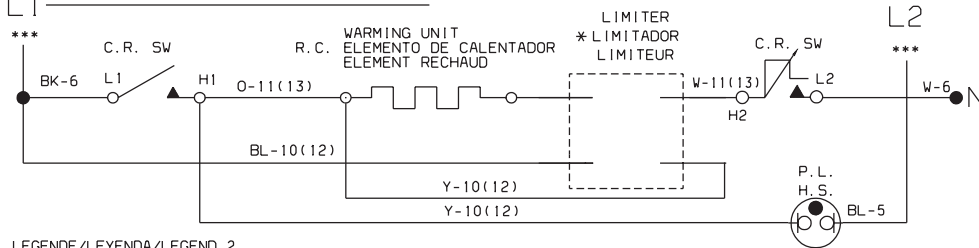

LEGENDE/LEYENDA/LEGEND 2

Y-11(13) ON/EN/SUR L.R. POSITION/POSICION/POSITION
W-11(13) ON/EN/SUR R.R. POSITION/POSICION/POSITION
BR-11(13) ON/EN/SUR R.F. POSITION/POSICION/POSITION
O-11(13) ON/EN/SUR L.F. POSITION/POSICION/POSITION

REMARK: FOR CONNECTING THE PLATFORM SEE INSTALLATION SHEET OR USE AND CARE GUIDE

LEGENDE/LEYENDA/LEGEND 3

MODEL WITH 4 PILOT LIGHT/MODELO Y 4 LAMPARA PILOTO / MODELE AVEC 4 LAMPES TEMOINS
BR-10(12) ON/EN/SUR L.F. POSITION/POSICION/POSITION
BL-10(12) ON/EN/SUR R.R. POSITION/POSICION/POSITION
GY-10(12) ON/EN/SUR R.F. POSITION/POSICION/POSITION
W-10(12) ON/EN/SUR L.R. POSITION/POSICION/POSITION

NOTA: PARA CONECTAR LA PARRILLA DE COCINAR, VER LA HOJA DE INSTALACION O EL MANUAL DEL USUARIO.

REMARQUE: POUR BRANCHER LA TABLE DE CUISSON VOIR LE FEUILLET D'INSTALLATION OU LE MANUEL D'UTILISATION ET D'ENTRETIEN.

MODEL WITH 1 PILOT LIGHT/MODELO Y 1 LAMPARA PILOTO/MODELE AVEC 1 LAMPE TEMOIN
J-10(12) ON ALL/TOUTES POSITIONS

CAUTION: DISCONNECT POWER BEFORE SERVICING UNIT.

ATENCION: DESCONECTE LA ENERGIA ANTES DE REALIZAR EL MANTENIMIENTO DEL ELECTRODOMESTICO.

ATTENTION: COUPER LE COURANT AVANT D'EFFECTUER LA REPARATION

CODE/CODIGO/STYLE/ESTILO/

CODE	GAUGE/MEDIDA/ CALIBRE	TEMP. °C	CSA	UL
1	18	125	CL1251	3173
2	16	125	CL1251	3173
3	14	125	CL1251	3173
4	12	125	CL1251	3173
5	18	150	EXL-150	3321
6	16	150	EXL-150	3321
7	14	150	EXL-150	3321
8	12	150	EXL-150	3321
9	10	150	EXL-150	3321
10	18	200	SEW-1	3122
11	16	200	SEW-1	3122
**12	18	250		3252
**13	16	250		3252
14	20	150	EXL-150	3321
15	8	150	EXL-150	3321
16	8	60		
17	10	60		

** NOTE: USED FOR CANADIANS MODELS
** NOTA: UTILIZADO PARA MODELOS CANADIENSES.
** NOTE: UTILISE POUR MODELES CANADIENS.
*** NOTE: USE PAGE 2 FOR GAGE AND WIRE COLOR.
*** NOTA: UTILIZAR LA PAGINA 2 PARA EL CALIBRE Y EL COLOR DE LOS CABLES.
*** NOTE: UTILISER LA PAGE 2 POUR LE CALIBRE ET ET LA COULEUR DU FIL.

*LIMITEUR/LIMITADOR/LIMITEUR CERAMASPEED/EIKA

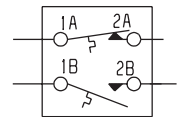

*LIMITEUR/LIMITADOR/LIMITEUR E.G.O./A.K.O.

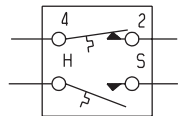

LEGEND/LEYENDA/LEGENDE

- SW. - SWITCH
INTERRUPTOR
INTERRUPTEUR
- P.L. - PILOT LIGHT
LAMPARA PILOTO
LAMPE TEMOIN
- R.F. - RIGHT FRONT
FRENTE DERECHO
AVANT DROIT
- R.R. - RIGHT REAR
TRASERO DERECHO
ARRIERE DROIT
- L.F. - LEFT FRONT
FRENTE IZQUIERDO
AVANT GAUCHE
- L.R. - LEFT REAR
TRASERO IZQUIERDO
ARRIERE GAUCHE
- R.C. - REAR CENTER
TRASERO CENTRO
ARRIERE CENTRE
- L.C. - LEFT CENTER
CENTRO DE IZQUIERDO
CENTRE GAUCHE
- H.S. - HOT SURFACE
SUPERFICIE CALIENTE
SURFACE CHAUDE

COLOR CODE/CODIGOS/
CODE COULEUR

- BL. - BLUE/AZUL/BLEU
- R. - RED/ROJO/ROUGE
- Y. - YELLOW/AMARILLO/JAUNE
- BK. - BLACK/NEGRO/NOIR
- W. - WHITE/BLANCO/BLANC
- O. - ORANGE/NARANJA/ORANGE
- BR. - BROWN/MORENO/BRUN

318046807 REV. D
P. 1

MODEL WITH REGULAR ELEMENT AND SELECTOR / MODELO Y ELEMENTO Y SELECTOR /
 MODELE AVEC ELEMENT REGULIER ET SELECTEUR

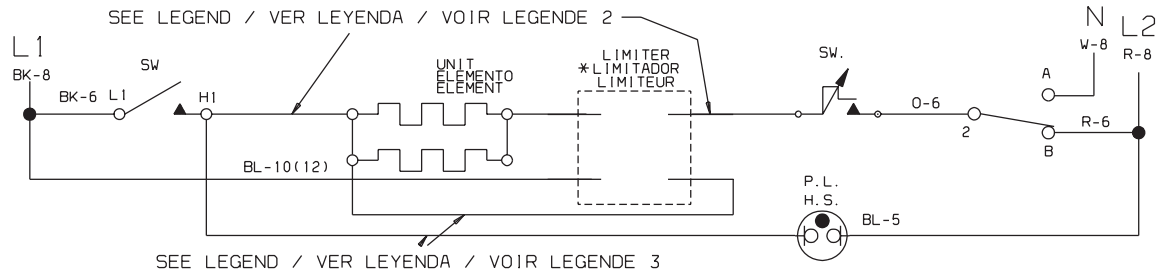

MODEL WITH WARMER ZONE / MODELO CON ZONA DE CALENTADOR /
 MODELE AVEC ZONE RECHAUD

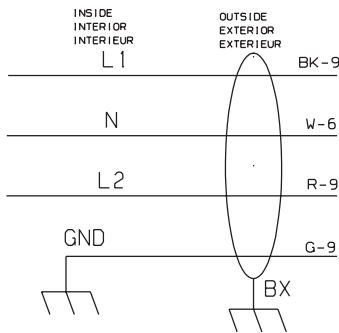

MODEL WITH 4 REGULAR UNITS / MODELO Y CUATRO ELEMENTOS
 REGULARES / MODELE AVEC ELEMENT REGULIER

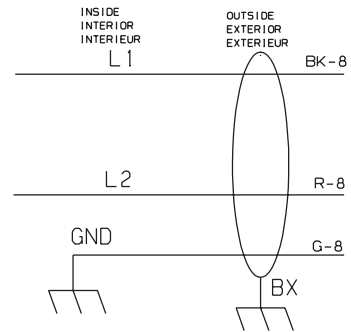

MODEL WITH OTHERS / OTROS MODELOS / AUTRE MODELES

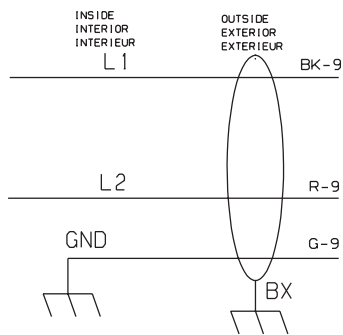

MODEL WITH SIMMER SELECT / LOS MODELOS CON SELECTOR DE HIRVE A
 FUEGO LENTO / MODELE AVEC SELECTEUR MIJOTANT

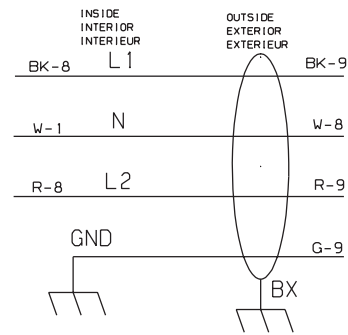

CAUTION: DISCONNECT POWER BEFORE SERVICING UNIT.
ATENCIÓN: DESCONECTE LA ENERGIA ANTES DE REALIZAR EL MANTENIMIENTO DEL ELECTRODOMESTICO.
ATTENTION: COUPER LE COURANT AVANT D'EFFECTUER LA REPARATION

318046807 REV. D
 P. 2