

**Speed Queen**

# User's Guide

for your  
topload  
washer

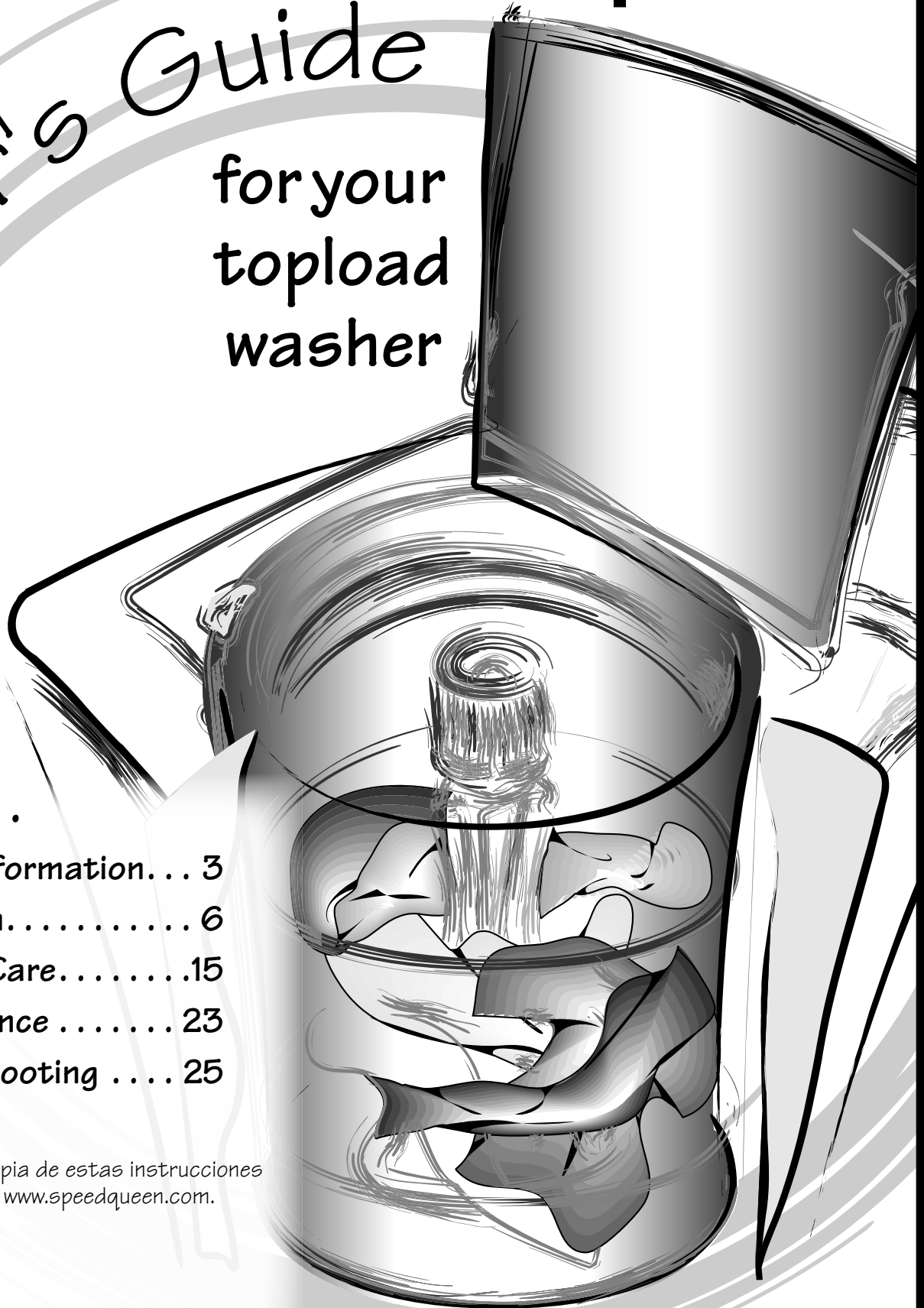

## Inside . . .

Safety Information . . .	3
Operation . . . . .	6
Clothing Care . . . . .	15
Maintenance . . . . .	23
Troubleshooting . . . .	25

Para bajar una copia de estas instrucciones en español, visite [www.speedqueen.com](http://www.speedqueen.com).



## WARNING

**For your safety and to reduce the risk of fire or an explosion, do not store or use gasoline or other flammable vapors and liquids in the vicinity of this or any other appliance.**

W022E

## Product Registration

*New owners of Speed Queen equipment are encouraged to register their appliance to insure proper warranty coverage.*

*Register by returning the product registration card enclosed in the accessories bag or online at [www.speedqueen.com](http://www.speedqueen.com).*

*All information will be kept confidential and will not be distributed to other parties.*

# Safety Information

## Explanation of Safety Messages

Throughout this manual and on machine decals, you will find precautionary statements (“DANGER,” “WARNING,” and “CAUTION”) followed by specific instructions. These precautions are intended for the personal safety of the operator, user, servicer, and those maintaining the machine.

	<b>DANGER</b>
Indicates an imminently hazardous situation that, if not avoided, will cause severe personal injury or death.	

	<b>WARNING</b>
Indicates a hazardous situation that, if not avoided, could cause severe personal injury or death.	

	<b>CAUTION</b>
Indicates a hazardous situation that, if not avoided, may cause minor or moderate personal injury or property damage.	

Additional precautionary statements (“IMPORTANT” and “NOTE”) are followed by specific instructions.

**IMPORTANT:** The word “IMPORTANT” is used to inform the reader of specific procedures where minor machine damage will occur if the procedure is not followed.

**NOTE:** The word “NOTE” is used to communicate installation, operation, maintenance or servicing information that is important but not hazard related.

## Important Safety Instructions

### Save These Instructions

	<b>WARNING</b>
To reduce the risk of fire, electric shock, serious injury or death to persons when using your washer, follow these basic precautions:	
W023	

1. Read all instructions before using the washer.
2. Refer to the *Grounding Information* in the Installation Instructions for the proper grounding of the washer.
3. Do not wash articles that have been previously cleaned in, washed in, soaked in, or spotted with gasoline, dry-cleaning solvents, or other flammable or explosive substances as they give off vapors that could ignite or explode.
4. Do not add gasoline, dry-cleaning solvents, or other flammable or explosive substances to the wash water. These substances give off vapors that could ignite or explode.



5. Under certain conditions, hydrogen gas may be produced in a hot water system that has not been used for two weeks or more. HYDROGEN GAS IS EXPLOSIVE. If the hot water system has not been used for such a period, before using a washing machine or combination washer-dryer, turn on all hot water faucets and let the water flow from each for several minutes. This will release any accumulated hydrogen gas. THE GAS IS FLAMMABLE. DO NOT SMOKE OR USE AN OPEN FLAME DURING THIS TIME.
6. Close supervision of children is necessary when the washer is used near children. This is a safety rule for all appliances.
7. Before the washer is removed from service or discarded, remove the lid to the washing compartment.
8. Do not reach into the washer if the washtub or agitator is moving.
9. Do not install or store the washer where it will be exposed to water and/or weather.
10. Do not tamper with the controls.
11. Do not repair or replace any part of the washer, or attempt any servicing unless specifically recommended in the user-maintenance instructions or in published user-repair instructions that you understand and have the skills to carry out.
12. To reduce the risk of an electric shock or fire, DO NOT use an extension cord or an adapter to connect the washer to the electrical power source.
13. Use your washer only for its intended purpose, washing clothes.
14. ALWAYS disconnect the washer from electrical supply before attempting any service. Disconnect the power cord by grasping the plug, not the cord.
15. Install the washer according to the Installation Instructions. All connections for water, drain, electrical power and grounding must comply with local codes and be made by licensed personnel when required. Do not do it yourself unless you know how!
16. To reduce the risk of fire, clothes which have traces of any flammable substances such as vegetable oil, cooking oil, machine oil, flammable chemicals, thinner, etc. or anything containing wax or chemicals such as in mops and cleaning cloths, must not be put into the washer. These flammable substances may cause the fabric to catch on fire by itself.
17. Do not use fabric softeners or products to eliminate static unless recommended by the manufacturer of the fabric softener or product.
18. Keep your washer in good condition. Bumping or dropping the washer can damage safety features. If this occurs, have your washer checked by a qualified service person.
19. Replace worn power cords and/or loose plugs.
20. Be sure water connections have a shut-off valve and that fill hose connections are tight. CLOSE the shut-off valves at the end of each wash day. Replace fill hoses every five years.
21. Lid MUST BE CLOSED any time the washer is to agitate or spin. DO NOT by-pass the lid switch by permitting the washer to agitate or spin with the lid open. A brake will stop the washtub within seconds if the lid is opened during spinning. If the washtub does not stop when the lid is opened, remove the washer from use and call the service person.
22. Check washer for water leaks after each use. If water is found, turn off the water supply and call for service immediately. Don't use washer until it is repaired by an authorized service agent.

23. If the washer's volume or type of sound changes from what is normally heard, call an authorized service agent immediately to prevent possible damage to other components.
24. Never start a cycle and leave the property without first checking to make sure the wash cycle is complete.
25. Always read and follow manufacturer's instructions on packages of laundry and cleaning aids. Heed all warnings or precautions. To reduce the risk of poisoning or chemical burns, keep them out of the reach of children at all times (preferably in a locked cabinet).
26. Always follow the fabric care instructions supplied by the garment manufacturer.
27. Never operate the washer with any guards and/or panels removed.
28. DO NOT operate the washer with missing or broken parts.
29. DO NOT by-pass any safety devices.
30. Failure to install, maintain, and/or operate this machine according to the manufacturer's instructions may result in conditions which can produce bodily injury and/or property damage.
31. Replace washer fill hoses every five years.

**NOTE: The WARNING and Important Safety Instructions appearing in this manual are not meant to cover all possible conditions and situations that may occur. Observe and be aware of other labels and precautions that are located on the machine. They are intended to provide instructions for safe use of the machine. Common sense, caution and care must be exercised when installing, maintaining, or operating the washer.**

Always contact your dealer, distributor or service agent about any problems or conditions you do not understand.

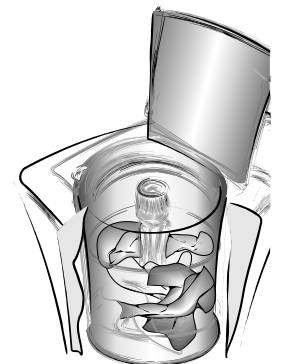

# Operation

## Before Washing

### Prepare Wash Load

#### Empty Pockets and Cuffs

Make sure all pockets are empty and turn them inside out. One bobby pin, metal or plastic toy, nail or sharp object in a load can catch laundry and cause tears. Facial tissue left in a pocket will produce extreme “lint”. A crayon or lipstick in a wash load may cause stains that cannot be removed. Roll down cuffs and shake out grass, sand and gravel.

#### Mend Rips and Tears

Little holes can become bigger in the washer. Mend holes and tears before placing garments in the washer.

#### Close Zipper and Fasten Hooks

These can catch on garments in a wash load and tear them. Tie belts and sashes so they won't wind around clothes.

#### Check For Colorfastness

Squeeze a portion of garment in warm or hot sudsy water. If the color bleeds or runs, wash the item separately in cold water.

### Sorting Items

Different items use different wash cycles and temperatures. Always follow the manufacturer's care label. Proper sorting is easy if you follow a few guidelines:

1. **Sort by Color:**

Separate items into loads of whites, darks, lights and non-colorfast.

#### Whites



TLW1991N

2. **Sort by Fabric and Construction:**

Separate items into loads of cottons/linens, permanent press, synthetics/blends/poly knits, and delicates.

#### Cottons



TLW1991N



TLW1990N

3. **Sort by Temperature:**

Separate items into loads that can be washed in cold, warm or hot water.

#### Cold



TLW1991N

4. **Sort by Type and Amount of Soil:**

Heavily soiled clothes will need extra treatment. Lightly soiled clothes can become dingy if washed with heavily soiled items.

5. **Sort Lint “Shedders” From Lint “Receivers”:**

Some fabrics attract lint and should not be washed with lint-shedding loads. Lint shedders are cottons, terry towels, chenille bedspreads, rugs and clothes that have been heavily bleached.

Lint receivers are synthetics, permanent or durable press, knits (including socks), corduroy, and other smooth fabrics.

### Pretreat

Pretreat shirt collars and cuffs with a pretreat product or liquid detergent when placing them in the washer. Before washing, treat special stains individually. Refer to *Stain Removal* section for procedures on treating specific stains.



## WARNING

Do not wash or dry items soiled with vegetable or cooking oils. Some oils may remain after washing and may cause the fabric to catch on fire by itself.

W527

- When washing very large items, do not fill washtub as full as with other loads.

### Water Level

- The water level in your washer should fit the size of your wash load. Small loads will use lower water levels. There must be enough water in the washtub to allow items to move and turn over freely.

## Loading the Washer

NOTE: Always add detergent first.

### Load Articles

- Load items by the amount of space they take up, not by their weight. Mix large and small items in a load to get the best washing results.
- Drop items loosely into the washtub. The bulk of the clothes rather than the weight will determine load size. Do not pack items in or wrap them around the agitator. Overloading can cause poor cleaning, excessive wrinkling and tears.

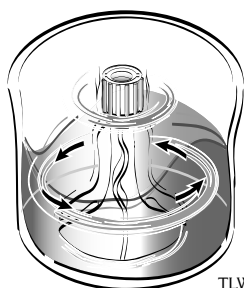

TLW1992N

- Items should move freely through the wash water for best cleaning results. Items should rollover, sink and then reappear.

Wrong Water Level for Size of Load



Right Water Level for Size of Load

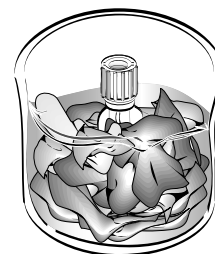

TLW1993N

- Overloading the washtub can result in poor washing and rinsing.
- Overloading may also cause wrinkling and tearing of items.

**IMPORTANT:** If in doubt, always use a higher water level. Most average loads will require a water setting between Medium and Extra Large. Failure to have the correct volume of water relative to the load will increase the incidence of excessive lint.

- Reset (OPTIONAL)  
Use the RESET if agitation has started and more water is needed for the load.

Load Sizes	
Mini (on select models only)	1-2 permanent press dress shirts or 2 pillow cases or 1 lightweight dress or similar size load
Small	3-4 permanent press dress shirts or 1 twin sheet, 1 pillow case or 1-2 lightweight dresses
Medium	6-7 permanent press shirts or 2 twin sheets, 2 pillow cases or 8 standard bath towels, 6 wash cloths
Extra Large	8-9 shirts, 5 pair polyester pants or 2 queen size sheets, 4 pillow cases, 2 nightgowns, 1 pair men's pajamas or 1 queen size bedspread

## Wash Temperature

### Hot Water

Hot water will give the best results of cleaning and sanitizing, but it is not suitable for all items. It is best for sturdy whites and colorfast items, heavily soiled items and diapers.

### Warm Water

By using warm water, there is less chance of color loss in items. Warm water also reduces wrinkling in permanent press items. Use with light and moderate soils, non-colorfast or dark colors, permanent press, silks, woolens, nylon, and acrylic.

### Cold Water

Cold water is less effective in cleaning than hot or warm water, but it does minimize wrinkling and color fading. Use it for washing extra-sensitive clothes and for the rinsing of all fabrics.

**NOTE: In wash temperatures colder than 60°F (15°C), detergents do not dissolve well. This may cause ineffective cleaning, or lint and residue to form.**

## Energy

You can save energy when washing by following a few guidelines:

1. Heating water accounts for the greatest energy expense when washing. Save on heating water by using warm or cold washes as well as cold rinses.
2. Wash full loads, but do not overload.
3. Use soak cycles for heavily soiled items to reduce wash times.
4. Select a shorter wash time for lightly soiled items.

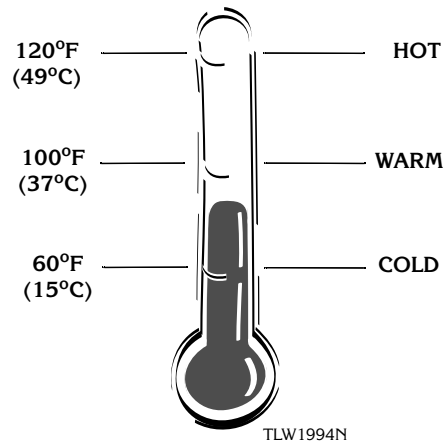

## Wash Temperature Guide

Water Temperature	Use	Comments
HOT (approximately 120°F [49°C], as determined by outside water supply)	<ul style="list-style-type: none"> <li>• Sturdy whites and colorfast items</li> <li>• Work clothes</li> <li>• Soiled items</li> <li>• Diapers</li> </ul>	<ul style="list-style-type: none"> <li>• Best cleaning for heavily soiled items</li> <li>• Best for sanitizing</li> </ul>
WARM (approximately 100° F [37°C]), as determined by outside water supply)	<ul style="list-style-type: none"> <li>• Rinsing of some items (OPTIONAL)</li> <li>• Light and moderately soiled items</li> <li>• Non-colorfast or dark colors</li> <li>• Permanent press</li> <li>• Silks, woolens, nylon, acrylic</li> </ul>	<ul style="list-style-type: none"> <li>• Reduces wrinkling in permanent press fabrics</li> <li>• Less fading</li> <li>• Reduces shrinking in knits</li> </ul>
COLD (approximately 60° F [15°C]), as determined by outside water supply)	<ul style="list-style-type: none"> <li>• Rinsing of most items</li> <li>• Non-colorfast fabrics</li> <li>• Extra sensitive clothing</li> </ul>	<ul style="list-style-type: none"> <li>• Saves energy</li> <li>• Reduces color fading</li> <li>• Reduces wrinkling</li> <li>• Reduces shrinking</li> </ul>

**NOTE: Some models regulate the hot and warm temperatures to save energy costs. In these models, hot water is approximately 102°F (39°C) and warm water is approximately 80°F (26°C).**



## Operating Your Washer



### WARNING

To reduce the risk of fire, electric shock, serious injury or death to persons, read the *Safety Information* section before operating your washer.

W522

### Determine Proper Cycle

(Some cycles may not be included on your model)

#### Regular Cycle

Use for sturdy items, like play or work clothes, towels, T-shirts, etc. The wash time selection will depend on the type of fabric and the amount of soil. For the best results when cleaning heavily soiled items, use a longer wash time (15 minutes maximum). Lightly soiled items require less wash time and spin out.

If available, use the Prewash setting for extra heavily soiled items. During the PREWASH setting, the washtub will fill with water, agitate for a reduced period of time and spin out.

There are three settings in the REGULAR cycle – Heavy, Normal and Light.

#### Permanent Press Cycle

Use for permanent press items and synthetics. The wash time selection will depend upon the type of fabric and amount of soil.

There are two settings in the PERMANENT PRESS cycle – Normal and Light.

#### Handwash/Delicate Cycle (on select models only)

Wash delicate items usually washed by hand on this cycle. A full tub of water is recommended (even for small loads) to allow the delicate items to move freely through the water. More water helps reduce fabric wear, wrinkling, and provides for a clean wash.

There are two settings in the HANDWASH/DELICATE cycle – Normal and Light.

#### Delicate Cycle (on select models only)

Wash delicate items usually washed by hand on this cycle. A full tub of water is recommended (even for small loads) to allow the delicate items to move freely through the water. More water helps reduce fabric wear, wrinkling, and provides for a clean wash.

There is one setting in the DELICATE cycle – Normal.

#### Handwash Cycle (on select models only)

Wash items usually washed by hand on this cycle. A full tub of water is recommended (even for small loads) to allow the delicate items to move freely through the water. More water helps reduce fabric wear, wrinkling, and provides for a clean wash.

#### Soak/Prewash (on select models only)

Use for heavily soiled or stained clothing. During the SOAK/PREWASH setting, the washtub will fill with water, agitate for a reduced period of time, pause for approximately 12 minutes, and spin out to complete the cycle.

#### Extra Rinse (on select models only)

This optional setting is useful for detergent sensitive skin. By pressing the “Extra Rinse” button to “ON,” the REGULAR, PERMANENT PRESS and HANDWASH/DELICATE cycles will each provide an additional rinse.

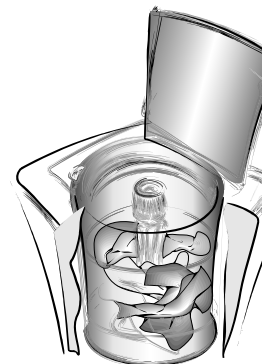

## Fabric Selector Setting (on select models only)

### Regular

This setting provides a regular agitation speed and a fast spin speed.

Use REGULAR setting for sturdy items like work or play clothes. Also use it for items that are heavily soiled.

### Perm Press

This setting provides a regular agitation speed and a slow spin speed.

Use PERM PRESS setting for most permanent press items and items that wrinkle easily.

### Knits

This setting provides a gentle agitation speed and a fast spin speed.

Use KNITS setting for loosely woven fabrics, sheer synthetics or cottons, loads that can give off excessive lint or for items that can be damaged by regular agitation.

### Delicates

This setting provides a gentle agitation speed and a slow spin speed.

Use DELICATES setting for delicate items, items that wrinkle easily like lightweight synthetics or lightweight permanent press.

## To Wash Clothes

**IMPORTANT:** Before using your new washer, make sure the washer cord is plugged into a 120 Volt electrical outlet that has the proper grounding and polarity. Make sure the washer hoses are connected to the hot and cold water faucets, and that the faucets are turned on. Be sure the drain hose is not kinked and is inserted into a drain. Refer to the INSTALLATION INSTRUCTIONS for details of proper washer installation.

**IMPORTANT:** Prior to first wash, use an all purpose cleaner, or a detergent and water solution, and a damp cloth to remove shipping dust from inside of washtub.

1. Get the clothes ready for washing. Empty pockets and cuffs. Sort items into separate loads. Pretreat stains and heavily soiled areas.



TLW1991N

**IMPORTANT:** Remove all sharp objects from laundry to avoid tears and rips to items during normal machine operation.

2. Measure and add detergent to the washtub. Follow instructions on detergent package for amount to use.

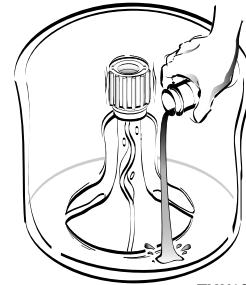

TLW1995N

3. Add clothes loosely into the washtub.

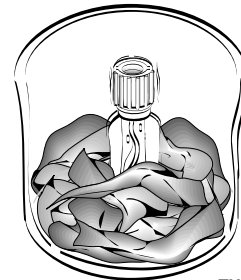

TLW1996N

4. Close the lid. The washer will not agitate or spin with the lid open.

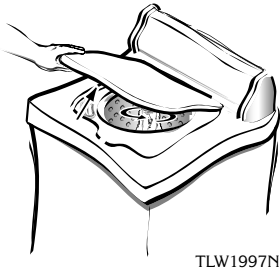

The Energy Saver settings, marked with an asterisk (\*), show which temperature settings will use the least energy.

6. Set LOAD SIZE (WATER LEVEL) control. Use RESET if agitation has started and more water is needed.

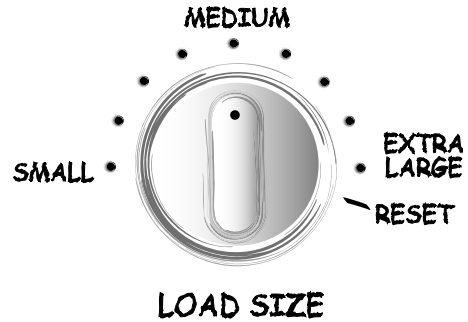

	<b>WARNING</b>
<p>To reduce the risk of serious injury, do not by-pass the lid switch by permitting the washer to agitate or spin with the lid open.</p>	
W523	

5. Set WASH/RINSE temperatures. (All rinses are cold.)

**NOTE:** Cold rinses will save you money and energy and will help reduce wrinkling in permanent press and synthetics.

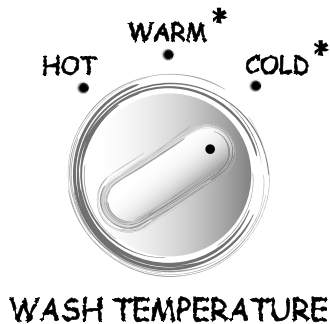

\* ENERGY SAVER  
TLW2079N

**IMPORTANT:** Holding the LOAD SIZE (WATER LEVEL) control in the RESET position can cause flooding of the washer.



7. Set Fabric Selector (on select models only).

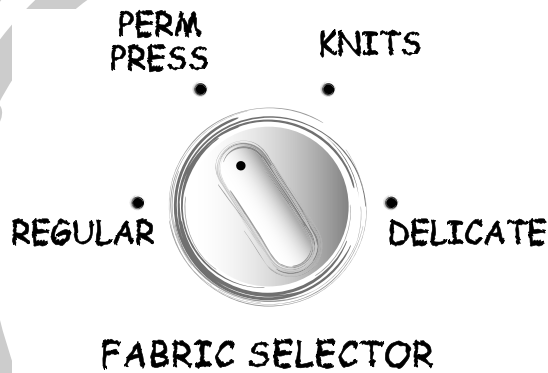

8. Select Extra Rinse (on select models only) if desired.



9. Select the cycle according to the type of fabric being washed. Push the timer knob in and turn clockwise to the desired cycle and wash time.

10. Pull the timer knob out to start the water fill. Agitation will begin when the water reaches the level you selected.

**NOTE: Lid must be closed for agitation and spin to start.**

The washer will stop (pause) shortly before the wash and rinse spins. Do not turn the timer through these pauses. They are part of the cycle.

## Timer

Although the washer cycles are automatic, the timer may be reset to lengthen, shorten or repeat a portion of a cycle.

To set or reset the timer, push timer knob in to stop the washer. Hold timer knob in firmly while turning it clockwise to the setting desired. Pull timer knob out to start the washer.

## Manual Soaking

Set the timer knob in the center of the word "RINSE" (this prevents the washer from spinning without first filling with water). Place the soaking product and clothes load in the washtub. Pull timer knob to start washer fill. After fill is completed and agitation has started, (lid must be closed) push the timer knob in. This will stop the washer. When the clothes have soaked the desired length of time, TURN THE TIMER KNOB TO THE START OF THE SPIN SETTING, then pull the timer knob out to start the spin.



## CAUTION

**Failure to turn the timer knob to the spin cycle and completely drain the washtub after soaking will result in the washer overflowing and cause property damage.**

W524

## Optional Features

### Bleach Dispenser

The bleach dispenser is located in the left front corner, under the lid.

Use liquid bleach in the dispenser. Powdered bleach must not be used in the dispenser. Add powdered bleach to the wash water.

Use no more than one cup chlorine bleach for large loads, three-quarters cup for medium and one-half cup for small loads.

Carefully pour recommended amount of bleach into the dispenser during the first fill of the washer.

Be careful not to spill undiluted bleach. It is a strong chemical and can damage some fabrics if it is not properly diluted.

### Fabric Softener Dispenser

#### *To Use Dispenser*

After the clothes are loaded into the washtub and before the start of the WASH cycle, pour the proper amount of liquid fabric softener into the bottle measuring cap (refer to bottle directions). Pour into dispenser.

The large fabric softener dispenser allows for the fabric softener to be diluted with water. We recommend adding water up to the fill level. Do not exceed tip of arrow which indicates correct fill level. Over-filling can allow fabric softener to spill onto the clothes, causing stains on clothes if the softener comes into contact with detergent suds.

Setting the water level to medium or higher will result in better performance from the fabric softener.

The fabric softener will remain in the dispenser during the wash fill, agitation and spin. At the end of the wash spin, the liquid fabric softener will be dispensed into the washtub through the slots in the agitator and will be mixed with the incoming rinse water.



## To Clean the Dispenser

Remove the dispenser housing from agitator by squeezing the lower part of the dispenser, pulling directly upward and at the same time tilting slightly. This will expose the dispenser cup, which is also removable, for cleaning (refer to illustration). Both housing and cup can be soaked in hot soapy water and rinsed clean. The funnel shape in top of agitator also needs to be cleaned. The hole and the slots in the two rings will require using a small brush for proper cleaning.

After cleaning, install dispenser cup, then push dispenser housing directly downward onto top of agitator until firmly snapped together.

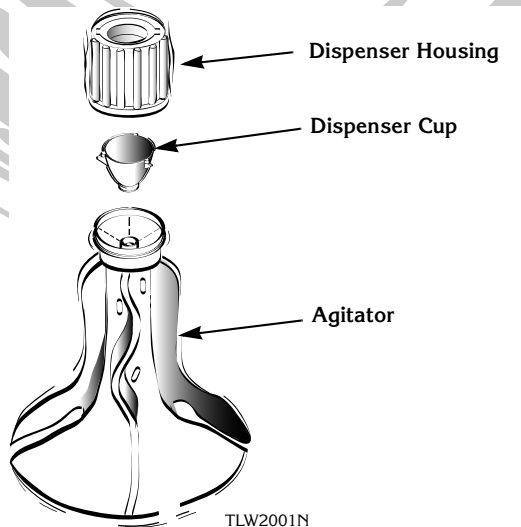

## Use Tips









- Fabric softener spilled onto garments may cause staining. To remove, dampen stain and rub with bar soap. Wash as usual.
- Liquid fabric softeners will be dispensed during the final rinse and should not be combined with bleach, bluing, starch, detergents, soaps or packaged water conditioners.
- Fabric softener is not to be used in dispenser when using Prewash cycle, if available.
- When adding detergent to wash water, do not allow any to enter into softener dispenser cup, as softener will become gummy.



To prevent softener buildup, the dispenser can be filled with clean water for automatic cleaning. This can be done in washing cycles other than when softener is used.







# Clothing Care















## Clothing Care Labels



The symbols below appear on many clothing care labels. Following the instructions on each label will help ensure the best laundry results.

WASH				
<b>Machine Wash Cycle</b>  Normal  Permanent Press/Wrinkle Resistant  Gentle/Delicate			<b>Hand wash</b> 	<b>Warning Signs</b>  Do not wash
<b>Water Temperature</b>  Hot  Warm  Cold			 Do not wring	

BLEACH		
<b>Bleach Symbols</b>  Any bleach (when needed)  Only non-chlorine bleach (when needed)		<b>Warning Signs</b>  Do not bleach

IRON				
<b>Iron - Dry or Steam</b>  Iron  High  Medium  Low				<b>Warning Signs</b>  Do not iron  No steam

DRY				
<b>Tumble Dry Cycle</b>  Dry  Normal  Permanent Press/Wrinkle Resistant  Gentle/Delicate				<b>Warning Signs</b>  Do not tumble dry
<b>Heat Setting</b>  High  Medium  Low  No heat/Air				 Do not dry (used with do not wash)
<b>Special Instructions</b>  Line dry/Hang to dry  Drip dry  Dry flat  In the shade				

DRYCLEAN	
<b>Dryclean</b>  Dryclean	<b>Warning Signs</b>  Do not Dryclean



# Washing Special Items

**NOTE: Always Follow Manufacturer's Care Label Instructions**

Bedding	<ul style="list-style-type: none"> <li>• Warm wash and warm rinse, if available.</li> <li>• Use PERMANENT PRESS cycle.</li> <li>• Pretreat heavily soiled areas before washing.</li> <li>• When washing an electric blanket, protect the plug by stitching the edge of the blanket over the plug. Only dry in dryer if manufacturer says it can be done.</li> </ul>
Diapers	<ul style="list-style-type: none"> <li>• Rinse out diapers immediately in cold water and soak in a diaper pail with a small amount of detergent or enzyme presoak. Soak before washing.</li> <li>• Limit wash load to two dozen cloth diapers.</li> <li>• Use an all-purpose detergent.</li> </ul>
Draperies, Curtains, Slip Covers	<ul style="list-style-type: none"> <li>• Shake to remove dust. Remove hooks and close zippers.</li> <li>• Sun-damaged draperies and curtains will not withstand washing.</li> <li>• Use warm water.</li> <li>• Wash curtains frequently. They can be weakened from soil, fumes, dust, and the sun.</li> <li>• Fiberglass curtains need gentle care. Read care label to see if washable. Some fiberglass curtains should be hand washed.</li> </ul>
Pillows (Feather and Down)	<ul style="list-style-type: none"> <li>• Do not wash pillows unless they can be dried in dryer. They may mildew if not dried completely.</li> <li>• Wash two pillows at a time or add towels for balance.</li> <li>• Use warm wash and cold rinse.</li> <li>• Stop the washer (by pushing the timer knob in) after water has filled half way. Submerge pillows to release trapped air. Start washer to complete fill. For best results, stop washer periodically during cycle to release air from pillows.</li> </ul>
Rugs	<ul style="list-style-type: none"> <li>• Shake before washing. Do not use hot water on rubber-backed rugs.</li> <li>• Wash two or three rugs to balance the washer.</li> </ul>
Slips and Nightgowns	<ul style="list-style-type: none"> <li>• Wash often using all-purpose detergent, warm or hot water and cold rinse on the PERMANENT PRESS cycle.</li> <li>• To keep nylons and polyesters white, wash only with whites and use chlorine bleach occasionally.</li> <li>• Use fabric softener in the rinse to remove static electricity.</li> </ul>
Shoes	<ul style="list-style-type: none"> <li>• Most shoes made of cloth and rubber can be washed.</li> <li>• Use the REGULAR cycle and warm water.</li> <li>• Wash with towels to balance the load.</li> </ul>
Cotton Knits	<ul style="list-style-type: none"> <li>• Unless the label indicates it is preshrunk, cotton knits will probably shrink to some degree.</li> <li>• Wash water should be hot or warm, suitable for color and soil.</li> <li>• Rinse water should be cold.</li> </ul>
Rayon Knits	<ul style="list-style-type: none"> <li>• Rayon stretches and shrinks easily. Treat as a delicate fabric and wash gently.</li> </ul>
Synthetic Fiber Knits	<ul style="list-style-type: none"> <li>• These items will generally keep their shape.</li> <li>• Make sure trimmings (including belts) are machine washable, seams are not puckered, and zippers and trimmings are well fastened.</li> </ul>
Knits of Manufactured Fibers	<ul style="list-style-type: none"> <li>• Use PERMANENT PRESS cycle.</li> <li>• Wash water should be warm, or suitable for color and soil.</li> <li>• Rinse water should be cold.</li> <li>• Do not wash with lint-shedding fabrics.</li> </ul>



Sweaters of Manufactured Fibers	<ul style="list-style-type: none"> <li>Follow directions for comparable knits.</li> <li>Button sweaters and turn inside out.</li> <li>Stretch to shape after washing.</li> <li>Avoid pulling when wet.</li> </ul>
Wool Items	<ul style="list-style-type: none"> <li>Unless labeled "machine washable," wash by hand.</li> </ul>
Permanent Press	<ul style="list-style-type: none"> <li>Wash often. Permanent press clothes tend to look clean even when they should be washed.</li> <li>Do not wash with lint-shedding loads.</li> <li>Pretreat grease stains and oily areas.</li> <li>Use the PERMANENT PRESS cycle, hot or warm water, cold rinse and sufficient detergent.</li> <li>Use fabric softener in the rinse water. This will reduce the static electricity which attracts lint and makes garments cling.</li> </ul>

## Clothing Concerns

To keep clothes looking white or bright, use good washing practices at all times to prevent a

gradual build-up of soil or water hardness minerals on them. If you notice that your clothes are not as bright as they should be, take corrective measures immediately.

Problem	Cause	Solution
Gray or Dingy Clothes	Insufficient Detergent	Add more detergent to washtub before loading clothes. Mild detergents are not suitable for average soil.
	Improper Sorting	Wash whites separately. Separate light from heavily soiled items. Clothes can pick up soil from dirty wash water.
	Nonphosphate Detergent and Hard Water	Follow package directions. Soften water if possible.
	Water Not Hot Enough	White clothes will stay whiter with hot wash water. Increase temperature.
	Overcrowding Washer	Clothes must circulate freely through the water for best results.
Yellowed Clothes	Unremoved Soil	Skin soil is hard to remove. Check hem edge of sheets and pillowcases, bottom end of t-shirts, etc. If this portion is white and center is yellow, the fabric contains unremoved soil. Use sufficient detergent and a hot wash. Chlorine bleach may be needed.
	Clothes Stained From Iron in the Water	To test if an iron stain, use a rust remover on a portion of the garment. Follow bottle directions for larger items.
	Older Clothes	Some white fabrics turn yellow with age and cannot be whitened.
Clothes Tearing or Damaged	Improper Use of Chlorine Bleach	No correction for bleach damaged clothes. Always measure and dilute bleach. Take extra care to avoid unwanted spilling.
	Overcrowding or Overloading	Make sure all items can move freely during agitation.
	Insufficient Pre-care	Fasten all hooks and zippers. Mend tears. Remove objects from pockets.

continued

<b>Problem</b>	<b>Cause</b>	<b>Solution</b>
Excessive Lint	Improper Sorting	Fabrics which shed lint cannot be washed with fabrics that receive lint.
	Insufficient Detergent / Non-phosphate Detergent	Use enough detergent so lint remains suspended in water and flushed out.
	Mixing Fabric Types	Knits and Permanent Press attract lint. Wash these only with similar items. Use fabric softener in rinse water.
Wrinkling	Improper Sorting	Heavy items like towels should not be washed with light items like nightgowns.
	Too Many Clothes in Washer	Clothes must circulate freely through the water for best results.
	Improper Cycle	Make sure cycle selected is appropriate for type of clothes.
	Improper Temperature	Using a warm or cold wash and a cold rinse reduces wrinkling.

## Laundry Products

<b>Laundry Aids</b>	<b>Use</b>	<b>Comments</b>
Soak/Pretreat Products	<ul style="list-style-type: none"> <li>Use an enzyme soaking product (Biz, Axion*) and follow steps under soaking instructions in the <i>Operating Your Washer</i> section or soak overnight to remove stains and soils.</li> <li>Always follow manufacturer's instructions with any pretreat product (Spray 'N Wash, Shout*, etc.).</li> </ul>	<ul style="list-style-type: none"> <li>Do not use a soaking product with chlorine bleach.</li> <li>Do not use pretreaters around the washer or dryer control panel. They may harm the finish or panel markings.</li> </ul>
Detergents/Soaps	<ul style="list-style-type: none"> <li>You may use detergents or soap in your washer. Powdered or liquid detergents can be used. Only use soap in soft water.</li> </ul>	<ul style="list-style-type: none"> <li>Always put detergent or soap into washtub before loading the clothes.</li> <li>Soap and nonphosphate powdered detergents will not give good washing results in hard water. Soap in hard water will form sticky deposits.</li> <li>The use of powdered soap is not recommended when washing in cold water.</li> </ul>
Bleaches	<ul style="list-style-type: none"> <li>Use to remove certain stains, disinfect, and keep clothes white.</li> <li>Use bleach in the wash water only. Do not use bleach in the rinse.</li> <li>Follow directions on clothing care label.</li> <li>Bleach should not be used as a substitute for detergent. Use the recommended amount of bleach.</li> </ul>	<ul style="list-style-type: none"> <li>When using liquid chlorine bleach, always use the bleach dispenser.</li> <li>Always measure the bleach. Never exceed one cup of bleach per full load.</li> <li>Never use chlorine bleach and ammonia in the same wash cycle.</li> </ul>

Laundry Aids	Use	Comments
Bleach Alternatives	<ul style="list-style-type: none"> <li>In some cases, mild bleaching may be accomplished using white vinegar, hydrogen peroxide or lemon juice as a pretreater.</li> <li>An oxygen bleach may be used in the wash cycle.</li> </ul>	<ul style="list-style-type: none"> <li>Always test to be sure that the product will not damage fabric by applying to a small part of the fabric that is not easily seen.</li> </ul>
Fabric Softeners	<ul style="list-style-type: none"> <li>Use to soften clothes and remove static electricity from permanent press knits and other fabrics of manufactured fibers.</li> <li>Add during the rinse cycle, or use the fabric softener dispenser, using no other product in the rinse. Follow bottle directions carefully.</li> </ul>	<ul style="list-style-type: none"> <li>Undiluted fabric softener poured directly on clothes can stain them.</li> <li>Do not mix with detergent or bleach.</li> </ul>

\* Brand names are trademarks of their respective manufacturers.

## Stain Removal

- Many soils will not become stains if treated promptly. Older stains may be difficult or impossible to remove. Hot water will set some stains, particularly protein based stains. Use cold or warm water on these before washing in hot water.
- Always follow the instructions on the clothing care label and instructions on stain removal products.
- When removing a stain, treat the stain from the back of the fabric unless otherwise noted. This will force the stain off the surface instead of driving it through the fabric.
- Always test to be sure that a stain removal product will not damage fabric by applying to a small part of the fabric that is not easily seen.

	<b>WARNING</b>
<p><b>Never put highly flammable substances like gasoline, kerosene, waxes, cooking oils, dry cleaning solvents, etc. into a washer or dryer. Never put articles that have been cleaned with such substances into a washer or dryer. Failure to comply with these warnings could result in a fire, explosion, and/or serious burns or death. All items with these substances on them should be thoroughly hand-washed with a detergent so that no trace of the flammable substances remains. The articles can then be machine washed and/or dried.</b></p> <p style="text-align: right;">W525</p> <p><b>Do not wash or dry items soiled with vegetable or cooking oils. Some oils may remain after washing and may cause the fabric to catch on fire by itself.</b></p> <p style="text-align: right;">W527</p>	

Stain	Treatment
Alcoholic Beverages	Rinse stain immediately with cold water or soak stain 30 minutes in cold water. Apply detergent or dishwashing liquid to any trace of stain while still wet. If safe for the fabric, wash in hot water using chlorine bleach.
Baby Food, Formula	Rinse with cold water. Soak with an enzyme soaking product. Rinse. Wash as usual. If stain remains, apply a pretreat product and wash again.

continued

Stain	Treatment
Blood	Treat stain immediately. Soak 30 minutes or more in cold water. Rub detergent into stain. If stain persists, place a small amount of household ammonia on the stain and rub again with detergent. If safe for fabric, wash in hot water and chlorine bleach if traces of the stain persist.
Candle Wax	Rub with ice and scrape off excess wax. Place stain between paper towels and press with warm iron. Then place stain face down on paper towels and sponge with rubbing alcohol, if safe for fabric (refer to WARNING on previous page). Let dry, wash. If traces of color remain, wash with commercial color remover (Rit, Putnam,* etc.) or, if safe for the fabric, hot water and chlorine bleach.
Cheese	Rinse with cold water. Soak with an enzyme soaking product. If the stain remains, apply a pretreat product. Wash as usual.
Chewing Gum	Rub with ice and scrape off excess gum. Place face down on paper towels and sponge with a pretreat product.
Chocolate or Cocoa	Rinse with cold water. Rub detergent into stain and soak in cold water. If greasy stain remains, sponge face down on paper towels with a pretreat product. If traces of the stain remain, wash in hot water and chlorine bleach (if safe for fabric).
Coffee, Tea	Soak in cold water. Rub detergent into stain, rinse. If traces of the stain remain, use a pretreat product and wash in warm water, or wash in hot water with chlorine bleach (if safe for fabric).
Copier Toner	Shake off loose powder. Brush stain with toothbrush to remove remaining powder. Sponge stain with soapy water. If stain remains, apply a pretreat product and wash in hot water (if safe for fabric).
Crayon	Treat the same as candle wax or place face down on paper towel and spray with WD-40*. Rinse. Wash in hot water (if safe for fabric) using soap (not a detergent) and 1-2 cups baking soda. If stains remain, professional drycleaning may be necessary.
Deodorants and Anti-Perspirants	Some of these products contain substances that can change the color of some dyes. The color can sometimes be restored if the area is sponged with ammonia then rinsed. To remove stains, apply white vinegar. Rub and rinse. If stains remain, rub detergent into stain and wash with hot water and chlorine bleach (if safe for fabric).
Dye	Treat with a commercial dye remover (Rit, Putnam*) or, if safe for fabric, bleach with chlorine bleach.
Egg, Gravy	If dried, scrape off excess. Soak in cold water. Rub detergent into damp stain and, if safe for fabric, wash in hot water and chlorine bleach.
Eye and Face Make-up	Tap on the stain with a spoon to loosen it. Rub dampened stain with bar soap, dishwashing liquid or detergent. If stain remains, soak in water and detergent. Apply a pretreat product and wash as usual.
Fabric Softener	Dampen stain and rub with bar soap. Wash as usual.
Felt-Tip Marker	Rub detergent into damp stain. Apply a pretreat product. If safe for fabric, wash in hot water and chlorine bleach.
Fruit Juices	Soak in cold water. Wash in hot water with chlorine bleach (if safe for fabric).
Grass	Place face down on paper towel and sponge with rubbing alcohol (if safe for fabric). Rinse. Apply a pretreat product and wash. If stain remains, wash in hot water with chlorine bleach (if safe for fabric).

Stain	Treatment
Grease, Oil	Place face down on paper towel and sponge with a pretreat product. Dampen stain with water and rub with bar soap or detergent. Wash in hot water (if safe for fabric).
Ink	Saturate the stain with hair spray or place the fabric face down on paper towel and sponge with rubbing alcohol (refer to WARNING on page 19). Rinse. If traces of the stain remain, rub detergent into the dampened stain and wash. Some inks may be impossible to remove.
Iodine	Rinse from the back side of the stain with cold water. Then soak in a commercial color remover (Rit, Putnam*, etc.) or rub in a paste of water and starch. Let stand for 15-30 minutes and wash.
Jam, Jelly	Scrape off excess. Rinse with cold water. Rub dampened stain with detergent. Apply a pretreat product and launder with an enzyme soaking product. If stain remains, sponge with a mild bleach, such as water and white vinegar mix (equal parts) and wash again.
Ketchup, Tomato-Based Products	Scrape off excess. Soak in cold water 30 minutes. Rub detergent into the stain and, if safe for fabric, wash in hot water and chlorine bleach.
Lipstick	Rub dampened stain with bar soap and wash.
Lotion (Hand, Body, Suntan)	Scrape off excess. Blot stain with paper towel. Rub colorless hand dishwashing liquid into stain and let stand several minutes. Rinse. Apply a pretreat product and wash in hot water (if safe for fabric.)
Mildew	Treat promptly. Mildew damages fabric and sometimes cannot be removed. Wash with chlorine bleach. For items that cannot be washed with chlorine bleach, soak in an all-fabric bleach, then wash.
Milk and Milk Products	Soak in cold water. Wash in hot water and chlorine bleach (if safe for fabric). Apply a pretreat product, if a stain is noticeable. Rewash.
Mud	Let dry. Scrape off excess. Soak in solution of one quart warm water, half teaspoon liquid hand dishwashing detergent and one tablespoon vinegar for 15 minutes. Rinse. Wash in hot or warm water with enzyme product.
Mustard	Rinse with cold water. Rub dampened stain with bar soap. Apply a pretreat product. Wash in hot water and chlorine bleach (if safe for fabric).
Nail Polish	Place face down on paper towel. Sponge with nail polish remover (non-oily) until stain disappears. Wash. Do not use nail polish remover on Acetate or Arnel fabrics.
Paint	Water-based – Treat by rinsing fabric in cool water while stains are still wet. Wash. To soften dried paint, apply soapy water or an acrylic paint and varnish remover. Rinse and then wash. Oil-based – Pretreat with a solvent recommended on the paint container. If not available, use mineral spirits. Rinse. Pretreat with a stain remover or detergent. Rinse and wash. Be sure to thoroughly rinse to remove all solvents to prevent a possible explosion in washer.
Perspiration	Rub dampened stain with detergent. Wash in hot water and chlorine bleach (if safe for fabric). If the fabric is discolored, you can try to restore it by treating fresh stains with ammonia or old stains with vinegar.
Rust	Apply a mild bleach such as lemon juice or a commercial rust remover (Whink, Rit, RoVer*, etc.) Follow manufacturer's directions. Wash as usual.
Salad Dressing, Mayonnaise	Scrape off excess. Apply a pretreat product. Rub stain with an enzyme soaking product and wash with hot water (if safe for fabric.). Do not leave washer unattended as remaining residue may cause fabric to catch on fire.

continued

<b>Stain</b>	<b>Treatment</b>
Scorching	Wash using hot water and chlorine bleach (if safe for fabric). Fabrics can be damaged by being scorched. If this has happened, you may not be able to remove the marks.
Shoe Polish	Rub dampened stain with detergent. Wash in hot water and chlorine bleach if safe for fabric.
Soft Drinks	Rinse stain with cold water immediately. Wash in warm water and chlorine bleach, if safe for fabric.
Soy Sauce	Rinse with cold water. Apply a pretreat product. Wash as usual.
Tobacco	Dampen stain and rub with bar soap. Rinse. If necessary, soak in an all-fabric bleach solution. If stain remains, wash with chlorine bleach (if safe for fabric).
Toothpaste	Scrape off excess. Blot stain with enzyme soaking product and cold water. Rinse. Wash as usual.
Urine	Rinse with cold water. Soak with an enzyme soaking product. Wash in hot water with chlorine bleach (if safe for fabric). If the color of the fabric has changed, sponging the area with ammonia may restore the color.
Vomit	Soak in a solution of one quart warm water, half teaspoon liquid hand dishwashing detergent, and one tablespoon ammonia (if safe for fabric). Soak 15 minutes. Use sponge to loosen stain. Blot with toweling. Wash in hot water (if safe for fabric) with an enzyme product.
Wine	Treat immediately. Rinse with cold water or club soda. Rub dampened stain with detergent and let stand several minutes. Apply a pretreat product and wash.

\* Brand names are trademarks of their respective manufacturers.

# Maintenance

---

## Cold Weather Care

- If the washer is delivered on a cold day (below freezing), or is stored in an unheated room or area during the cold months, do not attempt to operate it until the washer has had a chance to warm up.

## Care of Your Washer

- Use only a damp or sudsy cloth for cleaning the control panel. Some spray pretreat products may harm the finish on the control panel.
- Wipe the washer cabinet as needed. If detergent, bleach or other washing products are spilled on the cabinet, wipe immediately. Some products will cause permanent damage if spilled on the cabinet.
- Do not use scouring pads or abrasive cleansers.
- The washtub will need no particular care though it may need rinsing or wiping after an unusual load has been washed. This also may be necessary if too little detergent has been used.
- Leave the lid open to allow the inside of the washer to dry out after use. This helps prevent musty odors from developing.
- Check the filter screens in the fill hoses for debris or damage at least once a year. Clean or replace them if necessary.

## Replacing Hoses

- Hoses and other natural parts deteriorate after extended use. Hoses may develop cracks, blisters or material wear from the temperature and constant high pressure they are subjected to.
- All hoses should be checked on a yearly basis for any visible signs of deterioration. Any hose showing the signs of deterioration listed above should be replaced immediately.
- All hoses should be replaced every five years.

## Vacations and Extended Non-Use

- To avoid possible property damage due to flooding, turn off the water supply to the washer whenever there will be an extended period of non-use.

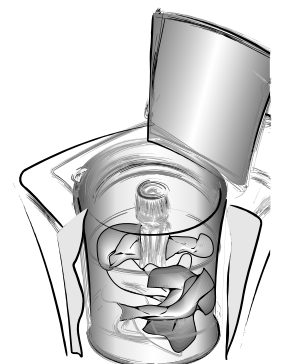

## Reinstallation of Shipping Materials

You must install the shipping brace and shipping plug any time the washer is moved.

### Shipping Brace

- The shipping brace in the lid opening should be saved and reinstalled whenever the washer is moved. To reinstall the brace, open the washer lid and place the brace over the washer agitator, placing the back of the brace into the washtub first.

### Shipping Plug

- The plastic shipping plug should be saved and reinstalled any time the washer is moved. The plug fits into two openings: The base opening and the shipping plug opening on the bottom of the mobile pivot dome. The plug **MUST** be inserted into both openings to prevent damage to the washer. In order to accomplish this, the shipping plug opening must be directly lined up with the base opening. Refer to illustrations below.

- After the shipping brace has been installed in the lid opening, tilt washer back enough to access base opening.
- Insert shipping plug into base opening and, using the palm of your hand, push shipping plug into washer until it snaps into shipping plug opening.

### Motor Overload Protector

- The internal motor overload protector will stop the motor automatically if there are too many clothes in the washtub or if a failure has occurred within the machine. The overload protector will reset itself in two or three minutes and the motor will restart automatically. If the overload protector stops the motor again, remove the washer from use and call the service person to correct the problem.

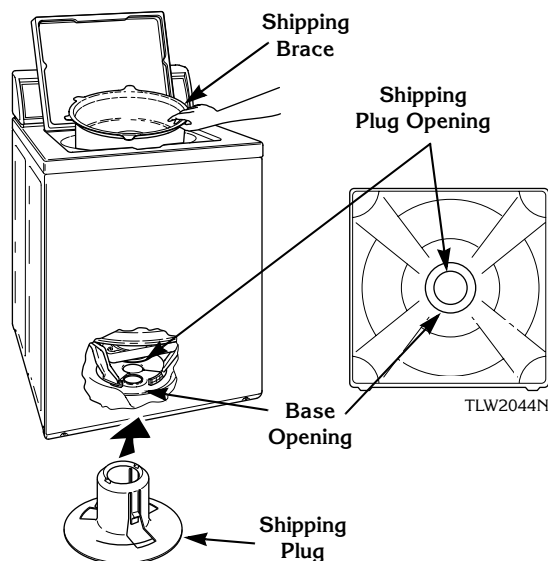



# Troubleshooting

Try these troubleshooting tips before making a service call. You may save time and money!

Washer Symptom	Possible Cause / Solution
Won't Fill	<ul style="list-style-type: none"> <li>• Make sure power cord is plugged all the way into the electrical outlet.</li> <li>• Make sure hot and cold water faucets are turned on.</li> <li>• Make sure that the fill hoses are not kinked or twisted.</li> <li>• Pull timer knob out to start washer.</li> <li>• Make sure that the controls are properly set.</li> <li>• Make sure that the last spin has been completed.</li> <li>• Check the house fuse or circuit breaker.</li> <li>• Clean the screens in the water mixing valve and the filter screens located at the faucet end of the fill hoses. (Owner is responsible for service calls regarding cleaning of the screens.)</li> <li>• Water is being siphoned from the washer during the cycle. Refer to the Installation Instructions to make sure that the drain hose has been properly installed.</li> </ul>
Won't Start	<ul style="list-style-type: none"> <li>• Make sure lid is closed.</li> <li>• Pull timer knob out to start washer.</li> <li>• Make sure power cord is plugged all the way into the electrical outlet.</li> <li>• Make sure that the controls are properly set.</li> <li>• Check the house fuse or circuit breaker.</li> <li>• The motor overload protector may have stopped the cycle. It will reset itself in two or three minutes and restart the washer automatically.</li> </ul>
Won't Agitate	<ul style="list-style-type: none"> <li>• Make sure lid is closed.</li> <li>• Pull timer knob out to start washer.</li> <li>• Make sure power cord is plugged all the way into the electrical outlet.</li> <li>• Check the house fuse or circuit breaker.</li> <li>• The motor overload protector may have stopped the cycle. It will reset itself in two or three minutes and restart the washer automatically.</li> <li>• Broken drive belt. Call the service person.</li> </ul>
Won't Spin	<ul style="list-style-type: none"> <li>• Make sure lid is closed.</li> <li>• Pull timer knob out to start washer.</li> <li>• Make sure power cord is plugged all the way into the electrical outlet.</li> <li>• Check the house fuse or circuit breaker.</li> <li>• The motor overload protector may have stopped the cycle. It will reset itself in two or three minutes and restart the washer automatically.</li> <li>• Broken drive belt. Call the service person.</li> </ul>
Stops/Pauses During Cycle	<ul style="list-style-type: none"> <li>• Pauses are part of the washer's normal operation. The washer will stop (pause) shortly before the wash and rinse spins.</li> <li>• Check the house fuse or circuit breaker.</li> <li>• The motor overload protector may have stopped the cycle. It will reset itself in two or three minutes and restart the washer automatically.</li> </ul>
Won't Drain	<ul style="list-style-type: none"> <li>• Make sure drain hose is not kinked or twisted.</li> <li>• Make sure drain hose is not clogged.</li> <li>• Make sure drain receptacle is not clogged.</li> <li>• Refer to the Installation Instructions to make sure that the drain hose has been properly installed.</li> </ul>

continued

Washer Symptom	Possible Cause / Solution
Water Leaks	<ul style="list-style-type: none"> <li>• Check that fill hoses are properly installed on the faucets and the washer's water mixing valve.</li> <li>• Replace the fill hoses every five years.</li> <li>• Make sure drain receptacle is not clogged.</li> <li>• Check house plumbing.</li> <li>• Laundry load may be oversudsing or overloaded. Use less detergent (or low-sudsing detergent) and proper load sizes.</li> </ul>
Is Noisy	<ul style="list-style-type: none"> <li>• Wash load may be unbalanced. Open lid and redistribute the load.</li> <li>• Make sure washer is level. Uneven leveling can cause vibration.</li> </ul>
Load Is Too Wet	<ul style="list-style-type: none"> <li>• Wash load may be unbalanced. Open lid and redistribute the load.</li> <li>• Load is too small. Add items to make full load.</li> <li>• Make sure the correct spin speed is selected for the type of items being washed (if option is available on your model).</li> </ul>
Wrong Water Temperature	<ul style="list-style-type: none"> <li>• Make sure that the controls are properly set.</li> <li>• Check fill hoses. Make sure hot faucet hose is connected to hot mixing valve (indicated with "H" on the valve bracket) and cold faucet is connected to cold mixing valve (indicated with "C" on the valve bracket).</li> <li>• Make sure house water heater is adjusted properly.</li> </ul>

## Contact Information

If service is required, contact the nearest Factory Authorized Service Center. To find the nearest service center, visit us online at [www.speedqueen.com](http://www.speedqueen.com).

If you are unable to locate an authorized service center or are unsatisfied with the service performed on your unit, contact:

**Speed Queen**  
Shepard Street  
P.O. Box 990  
Ripon, Wisconsin 54971-0990  
[www.speedqueen.com](http://www.speedqueen.com)  
Phone: (920)748-3121

Date Purchased \_\_\_\_\_

Model Number \_\_\_\_\_

Serial Number \_\_\_\_\_

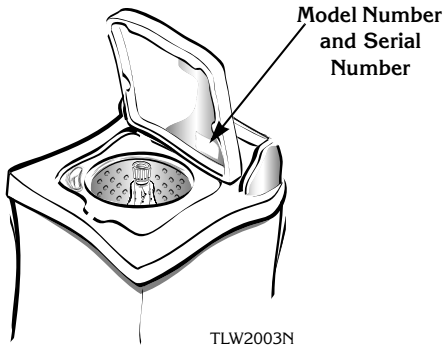

When contacting us about your washer, PLEASE GIVE THE MODEL AND SERIAL NUMBERS. The model and serial numbers are located on the nameplate. The nameplate will be in the location shown. Please include a copy of your bill of sale and any service receipts you have.

If replacement parts are required, contact the source from where you purchased your washer or visit us online at [www.speedqueen.com](http://www.speedqueen.com).

	<h2>WARNING</h2>
<p><b>To reduce the risk of serious injury or death, DO NOT repair or replace any part of the washer or attempt any servicing unless specifically recommended in the user-maintenance instructions or in published user-repair instructions that you understand and have the skills to carry out.</b></p>	
<small>W025E</small>	

