

# *Use & Care Manual*

## **Gas**

# *Wall Oven*

### **CONTENTS**

### **Page**

Versión en español .....	2
Product Registration .....	2
Important Safety Instructions .....	3-4
Grounding Instructions .....	5
Oven Ignition .....	5
Liquefied Petroleum (Propane) Gas Conversion (some models) .....	5
Oven Baking .....	6
Air Circulation in the Oven .....	6
Oven Cleaning .....	7-8
Setting the Controls for a Clean Cycle .....	8
General Cleaning .....	9
<b>Single Oven Models</b>	
• Before Setting Oven Controls .....	10
• Setting Oven Controls .....	10
• Adjusting Oven Temperature .....	10
• General Cleaning .....	10-11
• Changing Oven Light .....	11
<b>Double Oven Models</b>	
• Setting the Clock and Minute Timer .....	12
• Before Setting Oven Controls .....	13
• Setting Oven Controls .....	14
• General Cleaning .....	14-15
• Changing Oven Light .....	16
• Adjusting Oven Temperature .....	16
Avoid Service Checklist .....	17-18
Notes .....	19
Warranty .....	20

Visit the Frigidaire Web Site at:  
<http://www.frigidaire.com>

# Product Registration

## Register Your Product

The **PRODUCT REGISTRATION CARD** should be filled in completely, signed and returned to Electrolux Home Products North America.

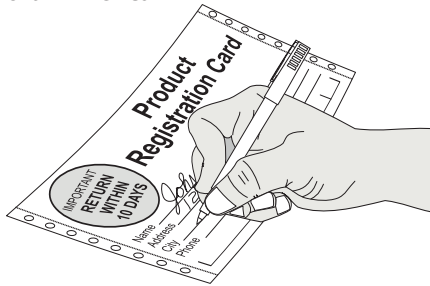

This Owner's Guide contains general operating instructions for your appliance and feature information for several models. Your appliance may not have all the described features.

## Versión en español

Si desea obtener una copia en español de este Manual del Usuario, sírvase escribir a la dirección que se incluye a continuación. Solicite la P/N **318204012**.

Electrolux Home Products  
Attn : Care Use  
P.O. Box 212378  
Augusta, GA 30917

**Thank you for choosing this appliance.** The information contained within this **Owner's Guide** will instruct you on how to properly operate and care for your wall oven. Please read through the information contained in your literature pack to learn more about your new appliance.

## Record Your Model and Serial Numbers

Record in the space provided below the model and serial numbers found on the serial plate located on the lower left hand inner trim of the oven or on the side of the lower oven frame (models with two ovens).

**Model Number:** \_\_\_\_\_

**Serial Number:** \_\_\_\_\_

**Date Purchased:** \_\_\_\_\_

**Note:** The instructions appearing in this Owner's Guide are not meant to cover every possible condition and situation that may occur. Common sense and caution must be practiced when installing, operating and maintaining any appliance.



**⚠ WARNING** If the information in this manual is not followed exactly, a fire or explosion may result causing property damage, personal injury or death.

### FOR YOUR SAFETY:

- Do not store or use gasoline or other flammable vapors and liquids in the vicinity of this or any other appliance.
- **WHAT TO DO IF YOU SMELL GAS:**
  - Do not try to light any appliance.
  - Do not touch any electrical switch; do not use any phone in your building.
  - Immediately call your gas supplier from a neighbor's phone. Follow the gas supplier's instructions.
  - If you cannot reach your gas supplier, call the fire department.
- Installation and service must be performed by a qualified installer, servicer or the gas supplier.

# IMPORTANT SAFETY INSTRUCTIONS

Read all instructions before using this appliance.  
Save these instructions for future reference.

This guide contains important safety symbols and instructions. Please pay special attention to these symbols and follow all instructions given. Here is a brief explanation of these symbols.

**⚠ WARNING** This symbol will help alert you to situations that may cause serious bodily harm, death or property damage.

**⚠ CAUTION** This symbol will help alert you to situations that may cause bodily injury or property damage.

- **Remove all tape and packaging wrap before using the appliance. Destroy the carton and plastic bags after unpacking the appliance.** Never allow children to play with packaging material. Do not remove the wiring label and other literature attached to the back of the appliance. Do not remove model/serial number plate.
- **Proper Installation—Be sure your appliance is properly installed and grounded by a qualified electrician or installer in accordance with the National Electrical Code ANSI/NFPA No. 70 (U.S.A.) or CSA C22.1, PART 1 (Canada)—latest editions and local code requirements.** Install only per installation instructions provided in the literature package for this appliance.

Ask your dealer to recommend a qualified installer, technician or an authorized repair service. Know how to disconnect the electrical power to the appliance at the circuit breaker or fuse box in case of an emergency.

**⚠ CAUTION** Electronic controllers can be damaged by cold temperatures. When you use your appliance for the first time, or if it has been used for a long period of time, make sure that it has been exposed to a temperature above 0°C/32°F for at least 3 hours before connecting it to the power supply.

- **User Servicing—Do not repair or replace any part of the appliance unless specifically recommended in the manuals.** All other servicing should be done only by a qualified technician. This may reduce the risk of personal injury and damage to the appliance.
- **Never modify or alter the construction of the appliance by removing panels, wire covers, or any other part of the product.**
- **Remove the oven door from any unused wall oven if it is to be stored or discarded.**

**⚠ WARNING** Stepping, leaning or sitting on the door(s) or drawer of this appliance can result in serious injuries and may also cause damage to the appliance. Do not allow children to climb or play around the appliance.

- **Storage in or on Appliance—Flammable materials should not be stored in an oven, or in the broiler drawer (if equipped).** This includes paper, plastic and cloth items,

such as cookbooks, plasticware and towels, as well as flammable liquids. Do not store explosives, such as aerosol cans, in or near the appliance.

**⚠ WARNING** Do not use the wall oven for storage.

**⚠ CAUTION** Do not store items of interest to children in the cabinets above an appliance. Children climbing on the appliance to reach items could be seriously injured.

- **Do not leave children alone—Children should not be left alone or unattended in the area where an appliance is in use.** They should never be allowed to sit or stand on any part of the appliance.

- **DO NOT TOUCH INTERIOR OVEN BURNER OR INTERIOR SURFACES OF THE WALL OVEN UNTIL THEY HAVE COOLED.** The oven heating burner may be hot even though the flames are not visible. Areas near the burner may become hot enough to cause burns. During and after use, do not touch, or let clothing or other flammable materials touch these areas until they have had sufficient time to cool. Among these areas are the oven vent openings, the surfaces near these openings, oven door, window and broiler drawer.

- **Wear Proper Apparel—Loose-fitting or hanging garments should never be worn while using the appliance.** Do not let clothing or other flammable materials contact hot surfaces.

**⚠ WARNING** NEVER use this appliance as a space heater to heat or warm the room. Doing so may result in carbon monoxide poisoning and overheating of the oven.

- **Do Not Use Water or Flour on Grease Fires—Smother the fire with a pan lid, or use baking soda, a dry chemical or foam-type extinguisher.**

- **When heating fat or grease, watch it closely.** Fat or grease may catch fire if allowed to become too hot.

- **Use Only Dry Potholders—Moist or damp potholders on hot surfaces may result in burns from steam.** Do not let the potholders touch the flame or burners. Do not use a towel or other bulky cloth instead of a potholder.

# IMPORTANT SAFETY INSTRUCTIONS (continued)

- **Do Not Heat Unopened Food Containers—Build-up of pressure may cause the container to burst and result in injury.**
- **Remove the oven doors from any unused appliance if it is to be stored or discarded.**
- **IMPORTANT—Do not attempt to operate the oven during a power failure. If the power fails, always turn the oven off.** If the oven is not turned off and the power resumes, the oven will begin to operate again. Food left unattended could catch fire or spoil.
- **Do not use the broiler pan without its insert.** The broiler pan and grid allow dripping fat to drain and be kept away from the high heat of the broiler.
- **Do not cover the broiler grid or oven bottom with aluminum foil.** Exposed fat and grease could ignite.
- **Do not touch a hot oven light bulb with a damp cloth.** Doing so could cause the bulb to break. Disconnect the oven or shut off the power to the oven before removing and replacing the bulb.

## IMPORTANT INSTRUCTIONS FOR USING YOUR OVEN

- **Use Care When Opening an Oven Door—**Stand to the side of the appliance when opening the door of a hot oven. Let hot air or steam escape before you remove or replace food in the oven.
- **Keep Oven Vent Ducts Unobstructed.** The wall oven is vented at the upper control panel trim or grille. Touching the surfaces in this area when the wall oven is operating may cause severe burns. Also, do not place plastic or heat-sensitive items near the oven vent. These items could melt or ignite.

**⚠ WARNING** NEVER cover any slots, holes or passages in the oven bottom or cover an entire rack with materials such as aluminum foil. Doing so blocks air flow through the oven and may cause carbon monoxide poisoning. Aluminum foil linings may trap heat, causing a fire hazard.

- **Placement of Oven Racks.** Always place oven racks in desired location while oven is cool. If the rack must be moved while the oven is hot, use extreme caution. Use potholders and grasp the rack with both hands to reposition. Do not let potholders contact the oven burner flame or interior of the oven or broiler drawer. Remove all utensils from the rack before removing the rack.

## IMPORTANT INSTRUCTIONS FOR CLEANING YOUR OVEN

- **Clean the wall oven regularly to keep all parts free of grease that could catch fire.** Do not allow grease to accumulate.
- **Kitchen Cleaners/Aerosols—**Always follow the manufacturer's recommended directions for use. Be aware that excess residue from cleaners and aerosols may ignite causing damage and/or injury.

## SELF-CLEANING OVENS

- **Clean in the self-cleaning cycle only the parts of the oven listed in this owner's guide.** Before self-cleaning the oven, remove the broiler pan and any utensils stored in the oven.
- **Do not clean the oven door gasket.** The door gasket is essential for a good seal. Care should be taken not to rub, damage or move the gasket.
- **Do not use oven cleaners.** No oven cleaner or oven liner protective coating of any kind should be used in or around any part of the oven.

**⚠ CAUTION** The health of some birds is extremely sensitive to the fumes given off during the self-clean cycle of any range. Move birds to another well ventilated room.

---

## IMPORTANT SAFETY NOTICE

The California Safe Drinking Water and Toxic Enforcement Act requires the Governor of California to publish a list of substances known to the state to cause cancer, birth defects or other reproductive harm, and requires businesses to warn customers of potential exposure to such substances.

# SAVE THESE INSTRUCTIONS

## Grounding Instructions (electric ignition models only)

**IMPORTANT: READ AND SAVE THESE INSTRUCTIONS.**

**⚠ WARNING** This appliance is equipped with a 3-prong grounding plug for your protection against shock hazard and should be plugged directly into a properly grounded receptacle. **DO NOT** cut or remove the grounding prong from this plug.

For personal safety, this oven must be properly grounded. For maximum safety, the power cord must be plugged into a 120V—60 Hz. outlet that is correctly polarized and properly grounded.

If a two-prong wall receptacle is the only available outlet, it is the personal responsibility of the consumer to have it replaced with a properly grounded three-prong wall receptacle installed by a qualified electrician.

**DO NOT UNDER ANY CIRCUMSTANCES CUT OR REMOVE THE THIRD ROUND GROUNDING PRONG FROM THE POWER CORD PLUG. SEE THE INSTALLATION INSTRUCTIONS PACKAGED WITH THIS OVEN FOR COMPLETE INSTALLATION AND GROUNDING INSTRUCTIONS. DO NOT OPERATE THE OVEN USING A TWO-PRONG ADAPTER OR AN EXTENSION CORD.**

**⚠ WARNING** Avoid fire hazard or electrical shock. Do not use an adaptor plug, an extension cord, or remove grounding prong from electrical power cord. Failure to follow this warning can cause serious injury, fire or death.

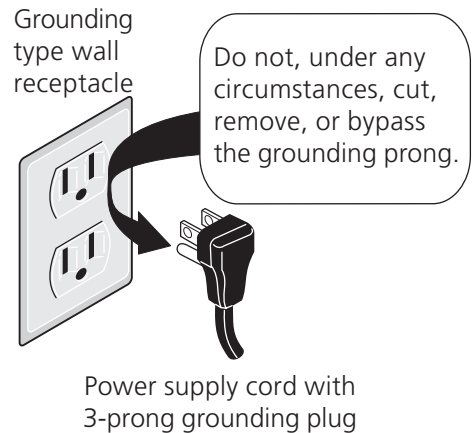

## Oven Ignition

When you turn the oven on, the glow bar igniter begins to heat. When the lighter is hot enough, in less than 1 minute, the gas flows into the burner and is ignited.

The igniter glows bright orange when hot. It cycles on and off with the thermostat and will glow whenever the burner is on.

**⚠ WARNING** Do not attempt to light the oven burners during a power failure. The oven burner valves will not open up and will prevent the gas from flowing through the burner valves to the burners. In the event of a power failure, turn the Temperature Control knob to OFF. When power resumes, turn the Temperature Control knob back to desired temperature.

## Liquefied Petroleum (Propane) Gas Conversion (some models only)

This appliance can be used with Natural Gas or Liquefied Petroleum (Propane) Gas. It is shipped from the factory for use with Natural Gas.

Refer to the Installation Instructions for conversion from Natural Gas to Propane Gas, or from Propane Gas to Natural Gas.

**⚠ WARNING** Severe shock or damage to the appliance may occur if the appliance is not installed by a qualified installer.





# Oven Baking

"Baking" means to cook foods such as cakes or casseroles by dry heat in a covered or uncovered pan. Roasting, often confused with baking, means to cook meat in an uncovered pan. To Bake or Roast, follow the instructions in the **Setting Oven Controls** section.

## Baking Problems and Solutions Chart (Below)

### Product Expectations

The cooking times and temperatures needed to bake a product may vary slightly from your previously owned appliance

Baking Problems	Causes	Corrections
<b>Cookies and biscuits burn on the bottom.</b> 	<ul style="list-style-type: none"> <li>• Cookies and biscuits put into the oven before the preheating time (10 minutes approx.) is completed.</li> <li>• Oven rack overcrowded.</li> <li>• Dark pan absorbs heat too fast.</li> </ul>	<ul style="list-style-type: none"> <li>• Allow oven to preheat to the selected temperature before placing food in oven.</li> <li>• Choose pan sizes that will permit 2-4" (5-10 cm) of air space on all sides when placed in the oven.</li> <li>• Use a medium-weight aluminum baking sheet.</li> </ul>
<b>Cakes too dark on top or bottom.</b> 	<ul style="list-style-type: none"> <li>• Cakes put into the oven before preheating time (10 minutes approx.) is completed.</li> <li>• Rack position too high or low.</li> <li>• Oven too hot.</li> </ul>	<ul style="list-style-type: none"> <li>• Allow oven to preheat to the selected temperature before placing food in the oven.</li> <li>• Use proper rack position for baking needs.</li> <li>• Set oven temperature 25°F/12°C lower than recommended.</li> </ul>
<b>Cakes not done in the center.</b> 	<ul style="list-style-type: none"> <li>• Oven too hot.</li> <li>• Incorrect pan size.</li> <li>• Pan not centered in oven.</li> </ul>	<ul style="list-style-type: none"> <li>• Set oven temperature 25°F/12°C lower than recommended.</li> <li>• Use pan size suggested in recipe.</li> <li>• Use proper rack position and place pan so there is 2-4" (5-10 cm) of space on all sides of pan.</li> </ul>
<b>Cakes not level.</b> 	<ul style="list-style-type: none"> <li>• Wall oven not level.</li> <li>• Pan too close to oven wall or rack overcrowded.</li> <li>• Pan warped.</li> <li>• Oven rack not level.</li> </ul>	<ul style="list-style-type: none"> <li>• Place a marked glass measuring cup filled with some water on the center of the oven rack. If the water level is uneven, refer to the installation instructions for leveling the range.</li> <li>• Be sure to allow 2-4" (5-10 cm) of clearance on all sides of each pan in the oven.</li> <li>• Do not use pans that are dented or warped.</li> <li>• Check oven rack for flatness and proper positioning.</li> </ul>
<b>Foods not done when cooking time is up.</b> 	<ul style="list-style-type: none"> <li>• Oven too cool.</li> <li>• Oven overcrowded.</li> <li>• Oven door opened too frequently.</li> </ul>	<ul style="list-style-type: none"> <li>• Set oven temperature 25°F/12°C higher than suggested and bake for the recommended time.</li> <li>• Be sure to remove all pans from the oven except the ones to be used for baking.</li> <li>• Open oven door only after shortest recommended baking time.</li> </ul>

## Air Circulation in the Oven

For best air circulation and baking results, center pans as much as possible. Allow 2-4" (5-10 cm) around the utensil(s) for proper air circulation and be sure pans do not touch each other, the door, sides or back of oven. The hot air must circulate around the pans in the oven for even heat to reach all parts of the oven.

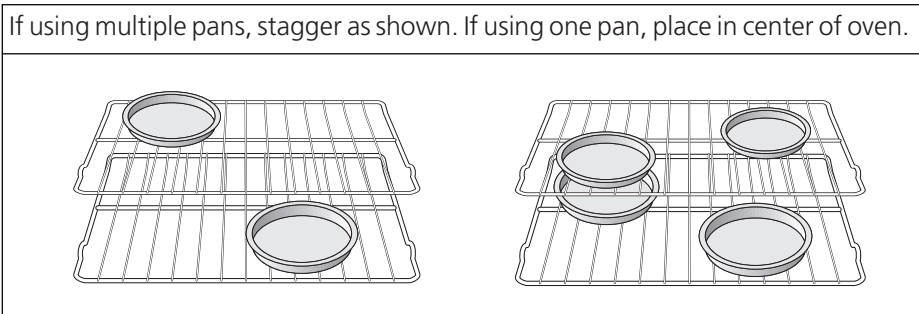

# Oven Cleaning

## Non Self-Clean Oven (some models)

Porcelain has a smooth finish and is a type of glass fused to metal. Oven cleaners can be used on all interior oven surfaces. REMOVE SPILLOVERS AND HEAVY SOILING AS SOON AS POSSIBLE. **REGULAR CLEANING WILL REDUCE THE NUMBER OF MAJOR CLEANING LATER.**

### Adhere to the following cleaning precautions:

- Allow the oven to cool before cleaning.
- Wear rubber gloves when cleaning the appliance manually.

### General Cleaning

Remove soils using hot, soapy water. Do not allow food spills with a high sugar or acid content (such as milk, tomatoes, sauerkraut, fruit juices or pie filling) to remain on the surface as they may cause a dull spot even after cleaning.

### To Remove Heavy Soil

1. Allow a dish of ammonia to sit in the oven overnight or for several hours with the oven door closed. Clean softened spots using hot, soapy water. Rinse well with water and a clean cloth.
2. If soil remains, use a soap-filled scouring pad or a nonabrasive cleaner. If necessary, use an oven cleaner following manufacturer's instructions. **DO NOT** mix ammonia with other cleaners.
3. Clean any soil from the oven frame, the door liner outside the oven door gasket and the small area at the front center of the oven bottom. Clean with hot, soapy water. Rinse well using clean water and a cloth.

### Adhere to the following precautions when using oven cleaners:

1. **DO NOT** spray on the electrical controls or switches because it could cause a short circuit and result in sparking or fire.
2. **DO NOT** allow a film from the cleaner to build up on the temperature sensing bulb; it could cause the oven to heat improperly. (The bulb is located in the rear of the oven.) Carefully wipe the bulb clean after each oven cleaning, being careful not to move the bulb. A change in its position could affect how the oven bakes. Avoid bending the bulb and capillary tube.
3. **DO NOT** spray any cleaner on the oven door trim or gasket, handles or any exterior surfaces of the range, wood or painted surfaces. The cleaner can damage these surfaces.

**⚠ CAUTION** Ammonia must be rinsed before operating the oven. Provide adequate ventilation.

**⚠ CAUTION DO NOT** line the oven walls, bottom, racks or any other part of the appliance with aluminum foil. Doing so will destroy heat distribution, produce poor baking results and cause permanent damage to the oven interior (aluminum foil will melt to the interior surface of the oven).

## Cleaning the Oven Bottom

**The oven bottom in non self-clean oven models can be removed for cleaning.** See "To Remove and Replace Oven Bottom" under **General Cleaning**.

Clean using hot, soapy water, a mild abrasive cleanser, a soap-filled abrasive pad or oven cleaner following manufacturer's instructions.

## Oven Cleaning (continued)

### Cleaning the Self-Clean Oven (some models)

#### Adhere to the following cleaning precautions

- Allow the oven to cool before cleaning.
- Wear rubber gloves when cleaning any exterior parts of the oven manually.

**⚠ CAUTION** During self-cleaning cycle, the outside of the oven can become very hot to touch. **DO NOT** leave small children unattended near the appliance.

Before cleaning any part of the oven, be sure the electronic oven control is turned off or else push **CANCEL** pad. Wait until oven is cool.

**DO NOT** use commercial oven cleaners or oven protective coatings in or around any part of the self-cleaning oven. **DO NOT** clean the oven door gasket. The gasket on the oven is essential for a good seal. Care should be taken not to rub, damage or move the gasket. **DO NOT** use any cleaning materials on the gasket. Doing so could damage it. **DO NOT** use aluminum foil to line the oven bottom. This may affect cooking or foil could melt and damage the oven surface.

A self-cleaning oven cleans itself with high temperatures (well above cooking temperatures) which eliminate soil completely or reduce it to a fine powdered ash you can whisk away with damp cloth.

#### PREPARING THE OVEN FOR SELF-CLEANING

1. Remove any excess spillovers in the oven cavity before starting the self-cleaning cycle. To clean, use hot soapy water and a cloth. Large spillovers can cause heavy smoke or fire when subjected to high temperatures. **DO NOT** allow food spills with a high sugar or acid content (such as tomatoes, sauerkraut, fruit juice or pie filling) to remain on the surface as they may cause a dull pot even after cleaning.
2. Clean any soil from the oven frame and the door liner. These areas heat sufficiently during a self-clean cycle to burn soil on. Clean with soap and water.
3. Remove the broiler pan and insert, all utensils and any foil. These items do not withstand high cleaning temperatures.
4. Oven racks may be left in the oven or may be removed. If they go through the lean cycle, their color will turn slightly dull. After the cycle is completed and the oven has cooled, rub the sides of the racks with wax paper or cloth containing a small amount of baby oil or salad oil. This will make racks glide easier.

#### WHAT TO EXPECT DURING CLEANING

While the oven is in operation, the oven heats to temperatures much higher than those used in normal cooking. Sounds or metal expansion and contraction are normal. Odor is also normal as the food soil is being removed. Smoke may appear though the oven vent.

If heavy spillovers are not wiped up before cleaning, they may flame and cause more smoke and odor than usual. This is normal and safe and should not cause alarm. If available, use an exhaust fan during the self-cleaning cycle.

## Setting the Controls for a Clean Cycle

For the setting of the clean cycle, refer to the section on the timer or Electronic Oven Control Guide.



# General Cleaning

## Cleaning Various Parts of Your Appliance

Before cleaning any part of the appliance, be sure all controls are turned OFF and the appliance is COOL. REMOVE SPILLOVERS AND HEAVY SOILING AS SOON AS POSSIBLE. REGULAR CLEANING WILL REDUCE THE NUMBER OF MAJOR CLEANING LATER.

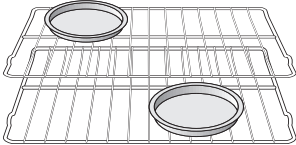
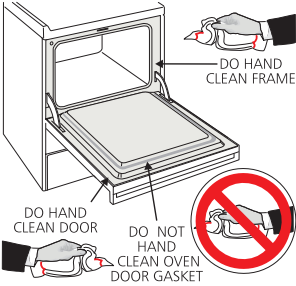
Surfaces	How to Clean
<b>Aluminum (Trim Pieces)</b>	Use hot, soapy water and a cloth. Dry with a clean cloth. <b>DO NOT</b> scour or use all-purpose cleaners, ammonia, powdered cleansers or commercial oven cleaner. They can scratch and discolor aluminum.
<b>Glass, Painted and Plastic</b> Body Parts and Decorative Trim	<i>For general cleaning,</i> use hot soapy water and a cloth. <i>For more difficult soils and built-up grease,</i> apply a liquid detergent directly onto the soil. Leave on soil for 30 to 60 minutes. Rinse with a damp cloth and dry. <b>DO NOT</b> use abrasive cleaners, spray cleaners or scouring pads on any of these materials. These cleaners can permanently damage the control pad surface.
<b>Control Panel</b>	<i>Before cleaning the control panel,</i> turn control to OFF and remove the control knob. To remove, pull knob straight off the shaft. Clean as instructed above. Squeeze excess water from the cloth before wiping the panel; especially when wiping around the control. Excess water in or around the control may cause damage to the appliance. To replace knob after cleaning, line up the flat sides of both the knob and the shaft, then push the knob into place.
<b>Porcelain Enamel</b> Broiler Pan and Grid, Door Liner, Broiler Drawer	Gentle scouring with a soapy scouring pad will remove most spots. Rinse with a 1:1 solution of clear water and ammonia. <i>If necessary,</i> cover difficult spots with an ammonia-soaked paper towel for 30 to 40 minutes. Rinse with clean water and a damp cloth, and then scrub with a soap-filled scouring pad. Rinse and wipe dry with a clean cloth. Remove all cleaners or the porcelain may become damaged during future heating.
<b>Oven and Broiler Rack(s)</b> 	<p><i>For Non Self-Clean Models:</i> Clean by using a mild, abrasive cleaner following manufacturer's instructions. Rinse with clean water and dry. After cleaning the racks, rub the sides of the racks with wax paper or a cloth containing a small amount of baby oil or salad oil (this will make the racks glide easier into the rack position).</p> <p><i>For Self-Clean Models:</i> Oven racks may be removed or left in the oven during the self-clean cycle for cleaning. If removed, follow instructions above.</p>
<b>Oven Door</b> 	<p>If the racks are cleaned in the self-clean cycle, their color will turn slightly blue and the finish will be dull. After the self-clean cycle is completed and the oven has cooled, rub the sides of the racks with wax paper or a cloth containing a small amount of baby oil or salad oil (this will make the racks glide easier into the rack positions).</p> <p>To clean oven door, wash with hot, soapy water and a clean cloth. <b>DO NOT</b> immerse the door in water. <b>DO NOT</b> clean the oven door gasket. The oven door gasket is made of a material which is essential for a good seal.</p> <p>Care should be taken not to damage or remove the oven door gasket.</p>

## Single Oven Models Only Before Setting Oven Controls

### Oven Vent Location

The oven is vented through the **upper control panel trim and grille** or through the **bottom grille of the upper control panel**. When the oven is on, warm air is released through the vents. This venting is necessary for proper burner operation in the oven and good baking results. **DO NOT** block the vents. Doing so may cause baking failures, fire or damage to the wall oven.

### Arranging Oven Racks

*ALWAYS ARRANGE OVEN RACKS WHEN THE OVEN IS COOL (PRIOR TO OPERATING THE OVEN).* Always use oven mitts when using the oven.

**To remove an oven rack**, pull the rack forward until it stops. Lift up front of rack and slide out.

**To replace an oven rack**, fit the rack onto the guides on the oven walls. Tilt the front of the rack upward and slide the rack back into place.

Some models have 2 flat racks. Other models have one flat rack and one offset rack. The rungs on the offset rack are slightly raised from the edges of the rack. This raised part of the rack is designed to allow easy and safe removal of foods from the lower racks of the oven and prevent hands from contacting the hot oven door. Always use the offset rack in the lower position.

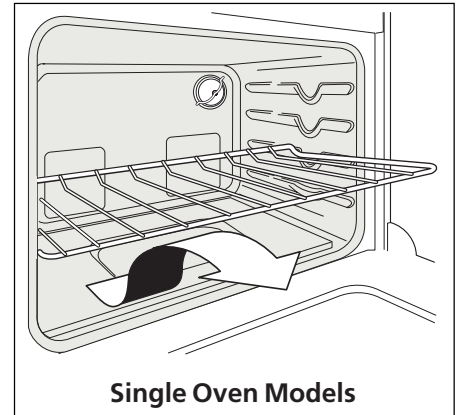

## Setting Oven Controls

For setting the oven controls, refer to the section on the timer or Electronic Oven Control Guide.

## Adjusting Oven Temperature

For instructions on how to adjust the oven temperature refer to Timer Section or Electronic Oven Control Guide.

## General Cleaning

### To Remove and Replace Oven Door (single Oven Models)

1. Open the door to the fully opened position.
2. Pull up the lock located on each hinge support and engage it in the hook of the hinge lever. You may have to apply a little downward pressure on the door to pull the locks fully over the hooks.
3. Grasp the door by the sides, pull the bottom of the door up and toward you to disengage the hinge supports.
4. Keep pulling the bottom of the door toward you while rotating the top of the door toward the appliance to completely disengage the hinge levers.
5. To reinstall the oven door, reverse steps 1 through 4. Make sure the hinge supports are fully engaged before unlocking the hinge levers.

**CAUTION** The door is heavy. For safe, temporary storage, lay the door flat with the inside of the door facing down.



## Single Oven Models Only (continued)

### General Cleaning (continued)

#### To Remove and Replace Oven Bottom (Single Oven Models)

##### To Remove the Oven Bottom:

1. Lift up the lift tab at the back of the oven bottom
2. Slide oven bottom out, and lift it up and out.

##### To Replace the Oven Bottom:

1. Slide horizontal tabs on back of oven bottom into the holes at the back of oven cavity.
2. Lower the front of the oven bottom so locking flange fits into locking channel.
3. Replace lift tab to hold oven bottom in place.

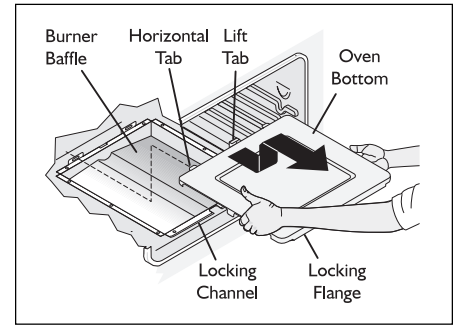

#### Storage Drawer (Single Oven, Self-Clean Models) or Broiler Drawer (Single Oven, Non Self-Clean Models)

The drawer can be removed to facilitate cleaning under the wall oven. Use care when handling the drawer.

##### To Remove the Storage or Broiler Drawer

1. Open and empty the drawer of all utensils.
2. Pull drawer out to drawer stop.
3. Tilt the drawer down and pull it out over the rollers. Or, tilt the drawer up and pull it out over the rollers (larger storage drawer models only).

##### To Replace the Storage or Broiler Drawer

1. Insert the rear end of the drawer into the opening.
2. Fit the end rollers onto the guide rails.
3. Hold the drawer in a horizontal position, then push in. Or, push the drawer in until it stops, then lift to allow the rollers to clear the roller guide stop and push in (larger storage drawer models only).

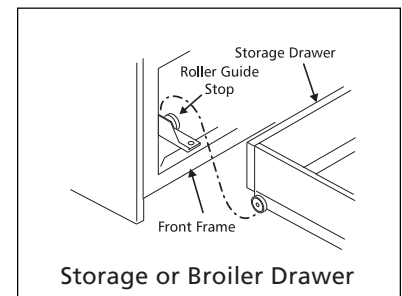

**⚠ WARNING** Flammable materials should not be stored in an oven or in the storage or broiler drawer or compartment (if equipped). This includes paper, plastic and cloth items, such as cookbooks, plasticware and towels, as well as flammable liquids. Do not store explosives, such as aerosol cans, on or near the appliance. Flammable materials may explode and result in fire or property damage.

## Changing Oven Light

**⚠ CAUTION** The oven light automatically turns on when the door is opened. Use the rocker switch located on the control panel to turn the oven light on or off when the door is closed.

Be sure the oven is unplugged and all parts are COOL before replacing the oven light. Wear a leather-faced glove for protection against possible broken glass.

##### To Change the Oven Light

1. Turn electrical power off at the main source or unplug the oven.
2. Press wire holder to one side to release the glass shield (some models).
3. Replace bulb with a new 40 watt appliance bulb.
4. Replace glass shield in socket and snap wire holder into place (some models).
5. Turn power back on again at the main source (or plug the oven back in).
6. The clock (if equipped) will then need to be reset. To reset, see **Setting the Clock and Minute Timer** in this Owner's Guide.

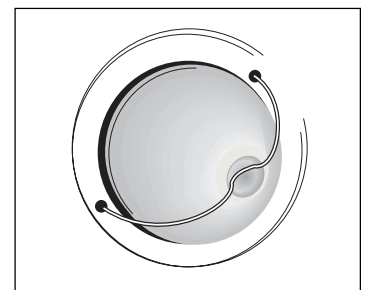

## Double Oven Models Only

### Setting the Clock and Minute Timer



#### To Set the Clock

When the range is first plugged in, or when the power supply to the appliance has been interrupted, "12:00" will flash in the display window.

1. Push **CLOCK** button to select clock entry mode. A beep will be heard.
2. Push **UP** or **DOWN ARROW** to set appropriate time. Adjust in one minute increments by tapping **UP** or **DOWN ARROW** or 10 minute increments by pressing and holding **UP** or **DOWN ARROW**. Set mode is exited 5 seconds after last **UP** or **DOWN ARROW** entry or 25 seconds after no entry.

#### To Set the Minute Timer

1. Press **TIMER** button. A beep will be heard.
2. The minute timer can be set for any amount of time from 1 minute to 12 hours.
3. Push **UP** or **DOWN ARROW** to set appropriate time. Adjusts in one minute increments by tapping **UP** or **DOWN ARROW** or 10 minute increments by pressing and holding **UP** or **DOWN ARROW**. Set mode is exited and timer begins counting down 5 seconds after last entry. Flashing colon indicates timer is active. Timer set mode is canceled if no button is pushed for 5 seconds.
4. A single beep will be heard 1 minute before the end of the selected time. When the time runs out, three quick beeps will be heard and a single reminder beep follows every 10 seconds for the 10 minutes or until the **CLOCK** button is pressed.
5. An active timer can be cancelled by pressing **TIMER** button with the timer in the display.

**NOTE:** Clock can be displayed during timer function by pressing **CLOCK** button. Flashing colon indicates timer is active in the background. To return to the timer display, press **TIMER** button.

## Double Oven Models Only (continued)

### Before Setting Oven Controls

#### Oven Vent Location

The oven is vented through the **upper control panel trim and grille** or through the **bottom grille of the upper control panel**. When the oven is on, warm air is released through the vents. This venting is necessary for proper burner operation in the oven and good baking results. **DO NOT** block the vents. Doing so may cause baking failures, fire or damage to the wall oven.

#### Arranging Oven Racks

*ALWAYS ARRANGE OVEN RACKS WHEN THE OVEN IS COOL (PRIOR TO OPERATING THE OVEN).* Always use oven mitts when using the oven.

**To remove an oven rack**, pull the rack forward until it stops. Lift up front of rack and slide out.

**To replace an oven rack**, fit the rack onto the guides on the oven walls. Tilt the front of the rack upward and slide the rack back into place.

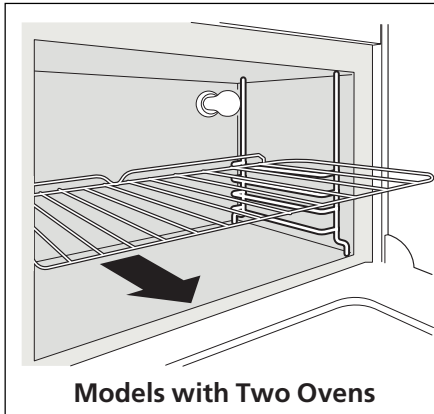

**Models with Two Ovens**

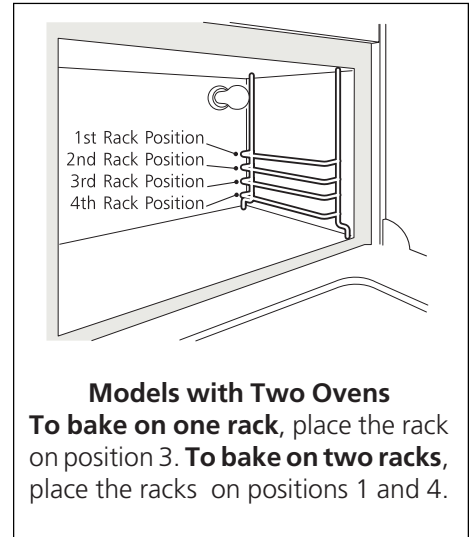

**Models with Two Ovens**  
**To bake on one rack**, place the rack on position 3. **To bake on two racks**, place the racks on positions 1 and 4.

Some models have 2 flat racks. Other models have one flat rack and one offset rack. The rungs on the offset rack are slightly raised from the edges of the rack. This raised part of the rack is designed to allow easy and safe removal of foods from the lower racks of the oven and prevent hands from contacting the hot oven door. Always use the offset rack in the lower position.

## Double Oven Models Only (continued)

### Setting Oven Controls

#### Bake (upper oven)

1. Arrange oven racks while the oven is still cool. See "Arranging Oven Racks" under **Before Setting Oven Controls**.
2. Push in and turn the Temperature Control knob to the desired temperature.
3. Preheat the oven for 10 to 12 minutes before baking. Preheating is not necessary when roasting, cooking casseroles or broiling most foods.
4. When cooking is finished, turn the Temperature Control knob to OFF.

#### Broil (lower oven)

1. Arrange oven rack(s) while oven is still cool. For rare meats, position the broiler pan closer to the burner (upper position). For well-done foods such as chicken, lobster tails or thick cuts of meat, position the pan further from the burner (lower position).
2. Push in and turn the Temperature Control knob to BROIL. You may adjust the Temperature Control knob down to avoid excess browning or drying of foods that should be cooked to the well-done stage.
3. Place the grid on the broiler pan, then place the meat on the grid. **DO NOT** use the broiler pan without the grid or cover the grid with aluminum foil. The exposed fat could ignite.
4. Place the pan on the oven rack. Close the oven door.
5. Broil on one side until food is browned; turn and cook on the second side. Season and serve. **Note:** Always pull the rack out to the stop position before turning or removing food.
6. When broiling is finished, turn the Temperature Control knob to OFF.

**CAUTION** Should an oven fire occur, leave the oven door closed and turn the oven off. If the fire continues, throw baking soda on the fire or use a fire extinguisher. **DO NOT** put water or flour on the fire. Flour may be explosive.

Temperature Control Knob

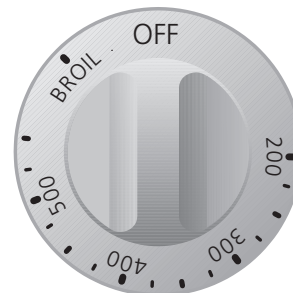

The broiler pan and its grid allow dripping grease to drain and be kept away from the high heat of the broiler. **DO NOT** use the pan without its grid. **DO NOT** cover the grid with foil. The exposed grease could ignite.

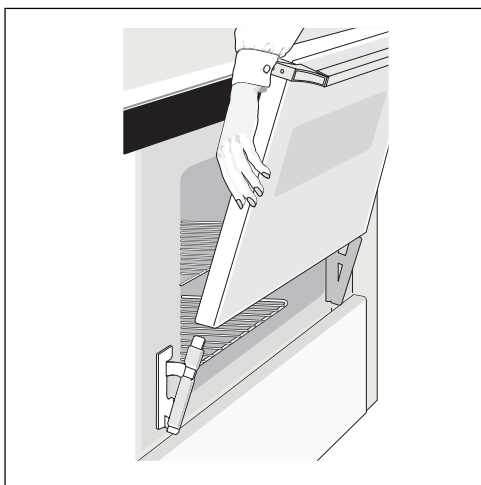
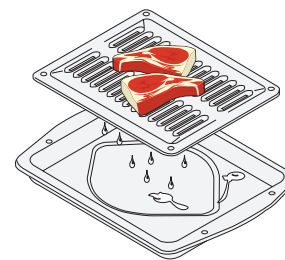

### General Cleaning

#### To Remove and Replace Oven Door

##### To Remove Oven Door:

1. Close the door about 3/4 of the way to the quarter-open position. Grasp the door firmly on both sides. Lift up and away from the wall oven.
2. To clean oven door, see the cleaning chart on page 11.

##### To Replace Oven Door:

1. Grasp the door firmly on both sides.
2. Place top of the hinge arm against the openings in the door. Push the bottom of the door in until the hinge is all the way into the opening, and slide down.
3. Close the oven door completely. If the door does not line up with the oven frame, remove the door and repeat the above steps.

The door is heavy. For safe, temporary storage, lay the door flat with the inside of the door facing down.

## Double Oven Models Only (continued)

### General Cleaning (continued)

#### To Remove and Replace Oven Bottoms

##### To Remove the Oven Bottom (upper oven):

1. Remove racks, broiler pan and wire guides.
2. Using the finger openings on each side of the oven bottom, pull out and lift up the oven bottom.

##### To Replace the Oven Bottom (upper oven):

1. Grasp the oven bottom and position the front tabs in place in the slots at the rear of the oven bottom.
2. Lower the front of the oven bottom and slide into place.
3. Replace wire guides.

**⚠ CAUTION** **Note:** If oven bottom fits too tightly, place your hand under the bottom through the lower cavity and push up on each side of the front end.

##### To Remove the Oven Bottom (lower oven):

1. Remove racks, broiler pan and wire guides.
2. Pull out and lift up the oven bottom.

##### To Replace the Oven Bottom (lower oven):

1. Lower the front of the oven bottom and slide into place.
2. Replace wire guides.

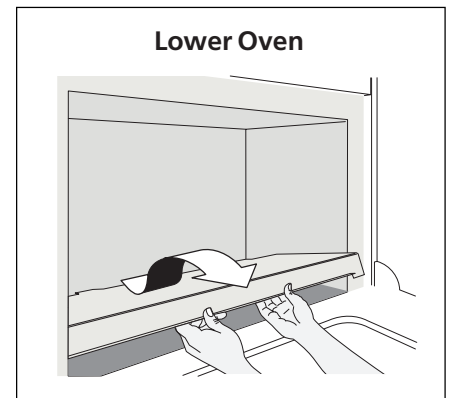
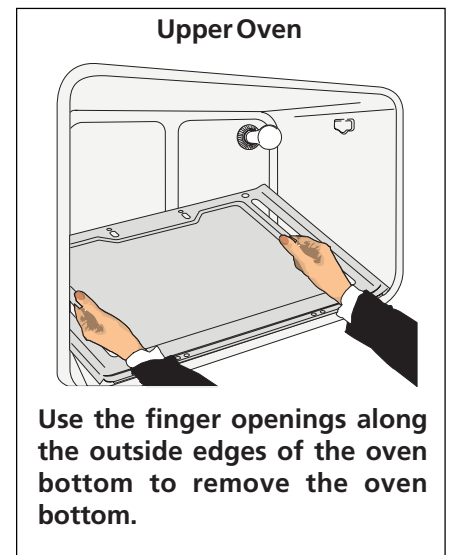

## Double Oven Models Only(continued)

### Changing Oven Light

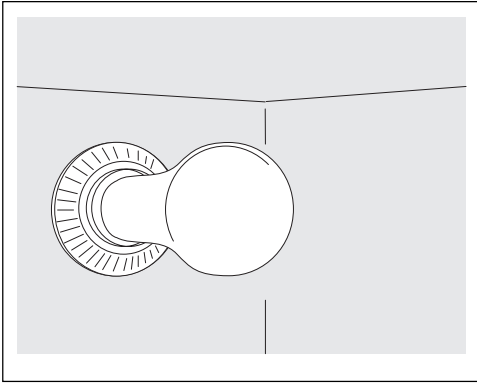

**CAUTION** Be sure the oven is unplugged and all parts are COOL before replacing the oven light. Wear a leather-faced glove for protection against possible broken glass.

Use the rocker switch on the control panel to turn the oven light on or off.

#### To Change the Oven Light (upper oven)

1. Turn electrical power off at the main source or unplug the oven.
2. Replace bulb with a new 40 watt appliance bulb.
3. Turn power back on again at the main source (or plug the oven back in).
4. The clock (if equipped) will then need to be reset. To reset, see **Setting the Clock and Minute Timer** in this Owner's Guide.

## Adjusting Oven Temperature(some models)

The temperature in the oven has been set at the factory. When first using the oven, be sure to follow recipe times and temperatures. If you think the oven is too hot or too cool, the temperature in the oven can be adjusted. Before adjusting, test a recipe by using a higher or lower temperature than the recommended temperature. The baking results should help you to decide how much of an adjustment is needed.

#### To Adjust Oven Temperature:

1. Check to be sure the Temperature control knob is in the OFF position.
2. Pull Temperature control knob straight off the shaft.
3. Loosen, but do not remove, the two screws at the back of the knob.  
**Note:** If knob does not have 2 screws, it is not adjustable. There is a series of small indicator grooves. One of these grooves is positioned next to a tiny pointer. Note the position of the pointer.
4. To increase the temperature, move the pointer in a clockwise direction. To decrease the temperature, move the pointer in a counterclockwise direction. The temperature can be adjusted in increments of 10°F.
5. When the desired adjustment is reached, tighten both screws.
6. To replace the knob, line up the flat sides of both the knob and the shaft. Push the knob into place. **DO NOT** force the Temperature Control knob onto the shaft or you may damage the back of the knob.

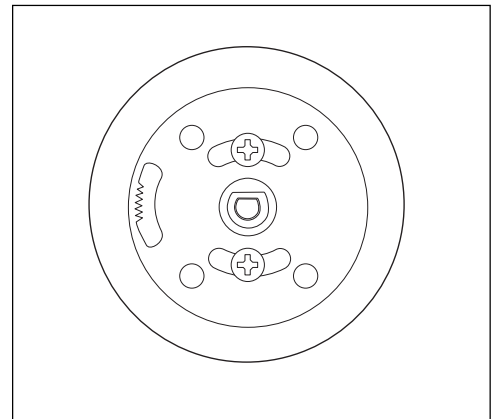

**Note:** Once an adjustment is made, the OFF position will vary from the reference mark on the backguard depending on the amount of adjustment.



## Avoid Service Checklist

Before you call for service, review this list. It may save you time and expense. The list includes common occurrences that are not the result of defective workmanship or materials in this appliance.

This oven is equipped with an electronic oven controller (some models). Among its many features is a full time oven circuit diagnostics system. The controller constantly monitors its internal circuitry as well as several crucial oven circuits, to insure they are all operating correctly. If at any time one of these systems fail, the controller will immediately shut down operation, and will beep and flash an error code of -F1-, -F3- or -F9- in the display window.

### OCCURRENCE

### POSSIBLE CAUSE/SOLUTION

---

**Oven Control Beeps and Displays -F1-  
-F3- or -F9-.**

Electronic control has detected a fault condition. Push **CANCEL** to clear the display and stop the display from beeping. Reprogram the oven. If a fault reoccurs, record the fault number, push the **CANCEL pad** and contact an authorized servicer.

---

**Oven is not level.**

Poor installation. Place a level on an oven rack in center of oven. Contact installing agent if rack is not level.

---

Kitchen cabinet misalignment may make oven appear to be unlevel. Be sure cabinets are square and level. Contact cabinet maker to correct problem.

---

**Entire appliance does not operate.**

Make sure cord/plug is securely plugged into electrical outlet.

---

Cord/plug is not installed or connected. Contact your dealer, installing agent or authorized servicer.

---

Service wiring not complete. Contact your dealer, installing agent or authorized servicer.

---

Power outage. Check house lights to be sure. Contact your local electric company.

---

Short in cord/plug. Replace cord/plug.

---

Controls are not set properly. See instructions in the **Oven Control Guide** to set the controls.

---

House fuse has blown or circuit breaker has tripped immediately following installation. House fuse may not be fully engaged. Check fuse or engage circuit breaker securely.

---

House fuse has blown or circuit breaker has tripped after the oven has been installed and previously operating. Call an authorized servicer.

---

Wall oven is not properly connected to gas supply. Check connection (see Installation Instructions).

---

**Oven does not operate.**

Make sure gas supply shut-off valve is opened before turning on the oven after installing the wall oven.

---

**Oven light does not work.**

Burned out or loose bulb. Follow instructions under **Changing Oven Light** to replace or tighten the bulb.

## Avoid Service Checklist (continued)

<b>Oven or Broiler drawer smokes excessively during broiling.</b>	<p>Door is open. Door should be closed during broiling.</p> <hr/> <p>Meat too close to the broil burner. Reposition the rack to provide more clearance between the meat and the broiler.</p> <hr/> <p>Meat not properly prepared. Remove excess fat from meat. Slash remaining fatty edges to prevent curling, but do not cut into the lean.</p> <hr/> <p>Grid on broiler pan wrong side up. Grease cannot drain into broiler pan. Always place the grid on the broiler pan with the ribs up and the slots down to allow grease to drip into the pan.</p> <hr/> <p>Broiler pan used without grid or grid covered with foil. DO NOT use the broiler pan without the grid or cover the grid with foil.</p> <hr/> <p>Grease spatters and food buildup cause excessive smoke. Regular cleaning is necessary when broiling frequently.</p>
<b>Poor Baking Results</b>	<p>Many factors affect baking results. See <b>Baking</b> for hints, causes and corrections. See <b>Arranging Oven Racks</b>.</p> <hr/> <p>If baked food items are too dark on top or bottom, allow the oven to preheat to set temperature before placing food in oven. Make sure the proper rack position is used when baking. Set temperature 25°F lower than recommended. If food is not done after recommended time, increase the set temperature 25°F.</p>
<b>Self-Cleaning cycle does not work.</b>	<p>Controls not set properly. Follow instructions under Oven Cleaning.</p> <hr/> <p>Self-cleaning cycle was interrupted. Stop time must be set 2-4 hours past the start time. Follow steps under "To Stop or Interrupt a Self-Cleaning Cycle" in the <b>Oven Cleaning</b> section.</p>
<b>Soil not completely removed after self-cleaning cycle is completed.</b>	<p>Failure to clean bottom, front top of oven, frame of oven or door area outside oven seal. These areas are not in the self-cleaning area, but get enough to burn on residue. Clean these areas before the self-cleaning cycle started. Burned on residue can be with a stiff nylon brush and water or a nylon scrubber. Be careful not to damage the oven gasket.</p> <hr/> <p>Excessive spillovers in oven. Set the self-cleaning cycle for a longer cleaning time.</p>
<b>Flames inside oven or smoke from vent.</b>	<p>Excessive spillovers in oven. This is normal, especially for high oven temperatures, pie spillovers or for large amounts of grease on bottom of oven. Wipe up excessive spillovers before starting the self-clean cycle.</p>

## Notes



## Major Appliance Warranty Information

Your appliance is covered by a one year limited warranty. For one year from your original date of purchase, Electrolux will pay all costs for repairing or replacing any parts of this appliance that prove to be defective in materials or workmanship when such appliance is installed, used and maintained in accordance with the provided instructions.

**Exclusions**      **This warranty does not cover the following:**

1. Products with original serial numbers that have been removed, altered or cannot be readily determined.
2. Product that has been transferred from its original owner to another party or removed outside the USA or Canada.
3. Rust on the interior or exterior of the unit.
4. Products purchased "as-is" are not covered by this warranty.
5. Food loss due to any refrigerator or freezer failures.
6. Products used in a commercial setting.
7. Service calls which do not involve malfunction or defects in materials or workmanship, or for appliances not in ordinary household use or used other than in accordance with the provided instructions.
8. Service calls to correct the installation of your appliance or to instruct you how to use your appliance.
9. Expenses for making the appliance accessible for servicing, such as removal of trim, cupboards, shelves, etc., which are not a part of the appliance when it is shipped from the factory.
10. Service calls to repair or replace appliance light bulbs, air filters, water filters, other consumables, or knobs, handles, or other cosmetic parts.
11. Surcharges including, but not limited to, any after hour, weekend, or holiday service calls, tolls, ferry trip charges, or mileage expense for service calls to remote areas, including the state of Alaska.
12. Damages to the finish of appliance or home incurred during installation, including but not limited to floors, cabinets, walls, etc.
13. Damages caused by: services performed by unauthorized service companies; use of parts other than genuine Electrolux parts or parts obtained from persons other than authorized service companies; or external causes such as abuse, misuse, inadequate power supply, accidents, fires, or acts of God.

**DISCLAIMER OF IMPLIED WARRANTIES; LIMITATION OF REMEDIES**

CUSTOMER'S SOLE AND EXCLUSIVE REMEDY UNDER THIS LIMITED WARRANTY SHALL BE PRODUCT REPAIR OR REPLACEMENT AS PROVIDED HEREIN. CLAIMS BASED ON IMPLIED WARRANTIES, INCLUDING WARRANTIES OF MERCHANTABILITY OR FITNESS FOR A PARTICULAR PURPOSE, ARE LIMITED TO ONE YEAR OR THE SHORTEST PERIOD ALLOWED BY LAW, BUT NOT LESS THAN ONE YEAR. ELECTROLUX SHALL NOT BE LIABLE FOR CONSEQUENTIAL OR INCIDENTAL DAMAGES SUCH AS PROPERTY DAMAGE AND INCIDENTAL EXPENSES RESULTING FROM ANY BREACH OF THIS WRITTEN LIMITED WARRANTY OR ANY IMPLIED WARRANTY. SOME STATES AND PROVINCES DO NOT ALLOW THE EXCLUSION OR LIMITATION OF INCIDENTAL OR CONSEQUENTIAL DAMAGES, OR LIMITATIONS ON THE DURATION OF IMPLIED WARRANTIES, SO THESE LIMITATIONS OR EXCLUSIONS MAY NOT APPLY TO YOU. THIS WRITTEN WARRANTY GIVES YOU SPECIFIC LEGAL RIGHTS. YOU MAY ALSO HAVE OTHER RIGHTS THAT VARY FROM STATE TO STATE.

**If You Need Service**

Keep your receipt, delivery slip, or some other appropriate payment record to establish the warranty period should service be required. If service is performed, it is in your best interest to obtain and keep all receipts. Service under this warranty must be obtained by contacting Electrolux at the addresses or phone numbers below.

This warranty only applies in the USA and Canada. In the USA, your appliance is warranted by Electrolux Major Appliances North America, a division of Electrolux Home Products, Inc. In Canada, your appliance is warranted by Electrolux Canada Corp. Electrolux authorizes no person to change or add to any obligations under this warranty. Obligations for service and parts under this warranty must be performed by Electrolux or an authorized service company. Product features or specifications as described or illustrated are subject to change without notice.

**USA**  
**1.800.944.9044**  
Electrolux Major Appliances  
North America  
P.O. Box 212378  
Augusta, GA 30907



**Canada**  
**1.800.668.4606**  
Electrolux Canada Corp.  
5855 Terry Fox Way  
Mississauga, Ontario, Canada  
L5V 3E4