



Non-Self-Cleaning Gas Ranges

Safety Instructions2-7, 25

Operating Instructions

Aluminum Foil12, 13
Clock and Timer10
Oven10-15
 Baking and Roasting12
 Broiling13, 14
 Broiling Guide14
 Oven Control11
 Power Outage11
 Preheating12
Surface Cooking8, 9
Thermostat Adjustment15

Care and Cleaning

Air Vents21
Broiler Pan and Grid21
Burner Assemblies16-18
Burner Caps and Heads18
Burner Grates17
Control Panel and Knobs21
Cooktop Surface19
Drip Pans16
Lift-Off Oven Door20
Lift-Up Cooktop19
Oven Bottom20
Oven Interior22, 23
Removable Broiler Drawer21
Shelves22
Stainless Steel Surfaces19

Installation

Instructions24-39
Anti-Tip Device28, 38, 39
Connect the Range
to Gas29-32
Convert to LP Gas39
Dimensions and
Clearances27
Electrical Connections33, 34
Level the Range38
Light the Pilots34-37

Troubleshooting Tips40-42

Accessories45

Consumer Support

Consumer
SupportBack Cover
Product Registration43, 44
Warranty for Customers
in Canada47
Warranty for Customers
in the U.S.A.46

**Owner's Manual
& Installation
Instructions**

*Standard-Clean
Models:*

- JGBS04 RGB508
- JGBS07 RGB524
- JGBS17 RGB528
- JGBS20 RGB533
- JGBS21 RGB540
- JGBS22
- JGBS23
- JGSS05

*Continuous-Clean
Model:*

- JGBC20

**Write the model and serial
numbers here:**

Model # _____

Serial # _____

You can find them on a label on the front of the range behind the kick panel or broiler drawer.



IMPORTANT SAFETY INFORMATION. READ ALL INSTRUCTIONS BEFORE USING.

⚠️ WARNING!

For your safety, the information in this manual must be followed to minimize the risk of fire or explosion, electric shock, or to prevent property damage, personal injury, or loss of life.



⚠️ WARNING! ANTI-TIP DEVICE

- ALL RANGES CAN TIP
- INJURY TO PERSONS COULD RESULT
- INSTALL ANTI-TIP DEVICES PACKED WITH RANGE
- SEE INSTALLATION INSTRUCTIONS

WARNING: If the information in this manual is not followed exactly, a fire or explosion may result causing property damage, personal injury or death.

- Do not store or use gasoline or other flammable vapors and liquids in the vicinity of this or any other appliance.

— WHAT TO DO IF YOU SMELL GAS

- Do not try to light any appliance.
- Do not touch any electrical switch; do not use any phone in your building.
- Immediately call your gas supplier from a neighbor's phone. Follow the gas supplier's instructions.
- If you cannot reach your gas supplier, call the fire department.
- Installation and service must be performed by a qualified installer, service agency or the gas supplier.



ANTI-TIP DEVICE

All ranges can tip and injury could result.

To prevent accidental tipping of the range, attach it to the wall by installing the Anti-Tip device supplied.

If the Anti-Tip device supplied with the range does not fit this application, use the universal Anti-Tip device WB2X7909.

To check if the device is installed and engaged properly, carefully tip the range forward. The Anti-Tip device should engage and prevent the range from tipping over.

If you pull the range out from the wall for any reason, make sure the device is properly engaged when you push the range back against the wall. If it is not, there is a possible risk of the range tipping over and causing injury if you or a child stand, sit or lean on an open door.

Please refer to the Anti-Tip device information in this manual. Failure to take this precaution could result in tipping of the range and injury.

⚠ WARNING!**IMPORTANT SAFETY NOTICE**

The California Safe Drinking Water and Toxic Enforcement Act requires the Governor of California to publish a list of substances known to the state to cause birth defects or other reproductive harm, and requires businesses to warn customers of potential exposure to such substances.

Gas appliances can cause minor exposure to four of these substances, namely benzene, carbon monoxide, formaldehyde and soot, caused primarily by the incomplete combustion of natural gas or LP fuels. Properly adjusted burners, indicated by a bluish rather than a yellow flame, will minimize incomplete combustion. Exposure to these substances can be minimized by venting with an open window or using a ventilation fan or hood.

**SAFETY PRECAUTIONS**

Have the installer show you the location of the range gas shut-off valve and how to shut it off if necessary.

- Have your range installed and properly grounded by a qualified installer, in accordance with the Installation Instructions. Any adjustment and service should be performed only by qualified gas range installers or service technicians.
- Do not attempt to repair or replace any part of your range unless it is specifically recommended in this manual. All other service should be referred to a qualified technician.
- Plug your range into a 120-volt grounded outlet only. Do not remove the round grounding prong from the plug. If in doubt about the grounding of the home electrical system, it is your personal responsibility and obligation to have an ungrounded outlet replaced with a properly grounded, three-prong outlet in accordance with the National Electrical Code. Do not use an extension cord with this appliance.

⚠ WARNING: *NEVER* use this appliance as a space heater to heat or warm the room. Doing so may result in carbon monoxide poisoning and overheating of the oven.

IMPORTANT SAFETY INFORMATION. READ ALL INSTRUCTIONS BEFORE USING.

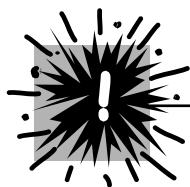

SAFETY PRECAUTIONS

- Locate the range out of kitchen traffic path and out of drafty locations to prevent pilot outage (on standing pilot models) and poor air circulation.
- Be sure all packaging materials are removed from the range before operating it to prevent fire or smoke damage should the packaging material ignite.
- Be sure your range is correctly adjusted by a qualified service technician or installer for the type of gas (natural or LP) that is to be used. Your range can be converted for use with either type of gas. See the *Installation of the range* section.

WARNING: These adjustments must be made by a qualified service technician in accordance with the manufacturer's instructions and all codes and requirements of the authority having jurisdiction. Failure to follow these instructions could result in serious injury or property damage. The qualified agency performing this work assumes responsibility for the conversion.

- Be careful when you clean the cooktop because the area over the pilot (on standing pilot models) will be hot.
 - After prolonged use of a range, high floor temperatures may result and many floor coverings will not withstand this kind of use. Never install the range over vinyl tile or linoleum that cannot withstand such type of use. Never install it directly over interior kitchen carpeting.
 - Do not leave children alone or unattended where a range is hot or in operation. They could be seriously burned.
 - Do not allow anyone to climb, stand or hang on the oven door, broiler drawer or cooktop. They could damage the range and even tip it over, causing severe personal injury.
 - **CAUTION:** Items of interest to children should not be stored in cabinets above a range or on the backsplash of a range—children climbing on the range to reach items could be seriously injured.
 - Clean only parts listed in this Owner's Manual.
 - Never wear loose fitting or hanging garments while using the appliance. Be careful when reaching for items stored in cabinets over the range. Flammable material could be ignited if brought in contact with flame or hot oven surfaces and may cause severe burns.
 - Do not store flammable materials in an oven, a range broiler or near a cooktop.
 - Do not store or use combustible materials, gasoline or other flammable vapors and liquids in the vicinity of this or any other appliance.
 - Do not let cooking grease or other flammable materials accumulate in or near the range.
 - Do not use water on grease fires. Never pick up a flaming pan. Turn the controls off. Smother a flaming pan on a surface burner by covering the pan completely with a well-fitting lid, cookie sheet or flat tray. Use a multi-purpose dry chemical or foam-type fire extinguisher.
- Flaming grease outside a pan can be put out by covering it with baking soda or, if available, by using a multi-purpose dry chemical or foam-type fire extinguisher.
- Flame in the oven can be smothered completely by closing the oven door and turning the control to off or by using a multi-purpose dry chemical or foam-type fire extinguisher.- Let the burner grates and other surfaces cool before touching them or leaving them where children can reach them.
- Never block the vents (air openings) of the range. They provide the air inlet and outlet that are necessary for the range to operate properly with correct combustion. Air openings are located at the rear of the cooktop, at the top and bottom of the oven door, and at the bottom of the range under the broiler drawer.
- Large scratches or impacts to glass doors can lead to broken or shattered glass.



COOK MEAT AND POULTRY THOROUGHLY...

Cook meat and poultry thoroughly—meat to at least an INTERNAL temperature of 160°F and poultry to at least an INTERNAL temperature of 180°F. Cooking to these temperatures usually protects against foodborne illness.



OVEN

Stand away from the range when opening the door of a hot oven. The hot air and steam that escape can cause burns to hands, face and eyes.

- Do not use the oven for a storage area. Items stored in the oven can ignite.
 - Keep the oven free from grease buildup.
 - Place the oven shelves in the desired position while the oven is cool.
 - Pulling out the shelf to the stop-lock is a convenience in lifting heavy foods. It is also a precaution against burns from touching hot surfaces of the door or oven walls. The lowest position is not designed to slide.
 - Do not heat unopened food containers. Pressure could build up and the container could burst, causing an injury.
 - Never use aluminum foil to line the oven bottom. Improper use of foil could start a fire and result in high carbon monoxide.
- ⚠ WARNING: NEVER** cover any slots, holes or passages in the oven bottom or cover an entire rack with materials such as aluminum foil. Doing so blocks air flow through the oven and may cause carbon monoxide poisoning. Aluminum foil linings may also trap heat, causing a fire hazard.
- When using cooking or roasting bags in the oven, follow the manufacturer's directions.
 - For continuous clean models, do not use oven cleaners on any of the continuous cleaning surfaces. Continuous cleaning surfaces can be identified by their rough surface finish.
 - Do not use your oven to dry newspapers. If overheated, they can catch fire.
 - Use only glass cookware that is recommended for use in gas ovens.
 - Always remove the broiler pan from range as soon as you finish broiling. Grease left in the pan can catch fire if oven is used without removing the grease from the broiler pan.
 - When broiling, if meat is too close to the flame, the fat may ignite. Trim excess fat to prevent excessive flare-ups.
 - Make sure the broiler pan is in place correctly to reduce the possibility of grease fires.
 - If you should have a grease fire in the broiler pan, turn off the oven control, and keep the broiler drawer and oven door closed to contain fire until it burns out.
 - For safety and proper cooking performance, always bake and broil with the oven door closed.

IMPORTANT SAFETY INFORMATION. READ ALL INSTRUCTIONS BEFORE USING.

Safety Instructions

Operating Instructions

Installation Instructions

Troubleshooting Tips

Consumer Support

⚠ **WARNING!**



SURFACE BURNERS

Use proper pan size—avoid pans that are unstable or easily tipped. Select cookware having flat bottoms large enough to cover burner grates. To avoid spillovers, make sure cookware is large enough to contain the food properly. This will both save cleaning time and prevent hazardous accumulations of food, since heavy spattering or spillovers left on range can ignite. Use pans with handles that can be easily grasped and remain cool.

- Always use the **LITE** position (on electric ignition models) or the **HI** position (on standing pilot models) when igniting the top burners and make sure the burners have ignited.
- Never leave the surface burners unattended at high flame settings. Boilovers cause smoking and greasy spillovers that may catch on fire.
- Adjust the top burner flame size so it does not extend beyond the edge of the cookware. Excessive flame is hazardous.
- Use only dry pot holders—moist or damp pot holders on hot surfaces may result in burns from steam. Do not let pot holders come near open flames when lifting cookware. Do not use a towel or other bulky cloth in place of a pot holder.
- When using glass cookware, make sure it is designed for top-of-range cooking.
- To minimize the possibility of burns, ignition of flammable materials and spillage, turn cookware handles toward the side or back of the range without extending over adjacent burners.
- Carefully watch foods being fried at a high flame setting.
- Always heat fat slowly, and watch as it heats.
- Do not leave any items on the cooktop. The hot air from the vent may ignite flammable items and will increase pressure in closed containers, which may cause them to burst.
- If a combination of oils or fats will be used in frying, stir together before heating or as fats melt slowly.
- Use a deep fat thermometer whenever possible to prevent overheating fat beyond the smoking point.
- Use the least possible amount of fat for effective shallow or deep-fat frying. Filling the pan too full of fat can cause spillovers when food is added.
- Do not flame foods on the cooktop. If you do flame foods under the hood, turn the fan on.
- Do not use a wok on the cooking surface if the wok has a round metal ring that is placed over the burner grate to support the wok. This ring acts as a heat trap, which may damage the burner grate and burner head. Also, it may cause the burner to work improperly. This may cause a carbon monoxide level above that allowed by current standards, resulting in a health hazard.
- Foods for frying should be as dry as possible. Frost on frozen foods or moisture on fresh foods can cause hot fat to bubble up and over the sides of the pan.
- Never try to move a pan of hot fat, especially a deep fat fryer. Wait until the fat is cool.
- Do not leave plastic items on the cooktop—they may melt if left too close to the vent.
- Keep all plastics away from the surface burners.
- To avoid the possibility of a burn, always be certain that the controls for all burners are at the **OFF** position and all grates are cool before attempting to remove them.
- If range is located near a window, do not hang long curtains that could blow over the surface burners and create a fire hazard.
- If you smell gas, turn off the gas to the range and call a qualified service technician. Never use an open flame to locate a leak.

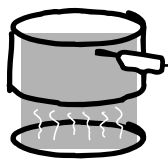

SURFACE BURNERS (cont.)

- Always turn the surface burner controls off before removing cookware.
- Do not lift the cooktop on sealed burner models. Lifting the cooktop can lead to damage and improper operation of the range.
- When a pilot goes out (on standing pilot models), you will detect a faint odor of gas as your signal to relight the pilot. When relighting the pilot, make sure burner controls are in the off position, and follow instructions in this book to relight.
- If you smell gas, and you have already made sure pilots are lit (on standing pilot models), turn off the gas to the range and call a qualified service technician. Never use an open flame to locate a leak.
- Do not place or store items that can melt or catch fire on the grates, even when the cooktop is not being used.
- Keep range clean and free of accumulations of grease or spillovers, which may ignite.



READ AND FOLLOW THIS SAFETY INFORMATION CAREFULLY.

SAVE THESE INSTRUCTIONS

Using the gas surface burners.

Throughout this manual, features and appearance may vary from your model.

Before Lighting a Gas Burner

- If drip pans are supplied with your range; they should be used at all times.
- Make sure all burners are in place.
- Make sure all grates on the range are properly placed before using any burner.

After Lighting a Gas Burner

- Do not operate the burner for an extended period of time without cookware on the grate. The finish on the grate may chip without cookware to absorb the heat.
- Be sure the burners and grates are cool before you place your hand, a pot holder, cleaning cloths or other materials on them.

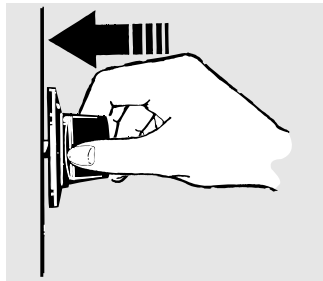

Push the control knob in and turn it to the **LITE** position (on electric ignition models) or **HI** (on standing pilot models).

How to Light a Gas Surface Burner

Make sure all the surface burners are placed in their respective positions.

Electric Ignition Models:

Push the control knob in and turn it to the **LITE** position.

You will hear a little **clicking** noise—the sound of the electric spark igniting the burner.

Turn the knob to adjust the flame size. If the knob stays at **LITE**, it will continue to click.

When one burner is turned to **LITE**, all the burners spark. Do not attempt to disassemble or clean around any burner while another burner is on. An electric shock may result, which could cause you to knock over hot cookware.

Standing Pilot Models:

Push control knob in and turn it to **HI** position. The burner should light within a few seconds.

Turn the knob to adjust the flame size.

Flame will be almost horizontal and will lift slightly away from the burner when the burner is first turned on. A blowing or hissing sound may be heard for 30–60 seconds. This normal sound is due to improved injection of gas and air into the burner. Put a pan on the burner before lighting it, or adjust the flame to match pan size as soon as it lights, and the blowing or hissing sound will be much less noticeable.

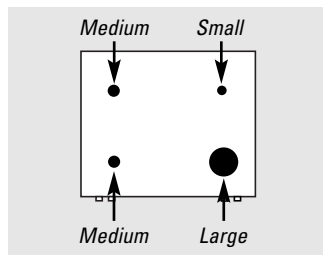

On Ranges with Sealed Gas Burners

The smallest burner in the right rear position is the simmer burner. This burner can be turned down to a very low simmer setting. It provides precise cooking performance for delicate foods such as sauces or foods that require low heat for a long cooking time.

The medium (left rear and left front) and the large (right front) burners are the primary burners for most cooking. These general-purpose burners can be turned down from **HI** to **LO** to suit a wide range of cooking needs.

NOTE: On some models, the burners are all the same size and power.

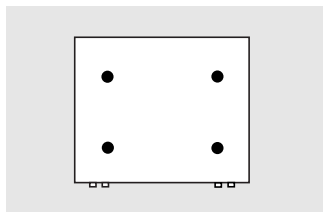

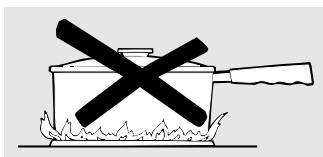

How to Select Flame Size

For safe handling of cookware, never let the flames extend up the sides of the cookware.

Watch the flame, not the knob, as you reduce heat. When fast heating is desired, the flame size on a gas burner should match the cookware you are using.

Flames larger than the bottom of the cookware will not result in faster heating of the cookware and could be hazardous.

Top-of-Range Cookware

Aluminum: Medium-weight cookware is recommended because it heats quickly and evenly. Most foods brown evenly in an aluminum skillet. Use saucepans with tight-fitting lids when cooking with minimum amounts of water.

Cast-Iron: If heated slowly, most skillets will give satisfactory results.

Enamelware: Under some conditions, the enamel of some cookware may melt. Follow cookware manufacturer's recommendations for cooking methods.

Glass: There are two types of glass cookware—those for oven use only and those for top-of-range cooking (saucepans, coffee and teapots). Glass conducts heat very slowly.

Heatproof Glass Ceramic: Can be used for either surface or oven cooking. It conducts heat very slowly and cools very slowly. Check cookware manufacturer's directions to be sure it can be used on gas ranges.

Stainless Steel: This metal alone has poor heating properties and is usually combined with copper, aluminum or other metals for improved heat distribution. Combination metal skillets usually work satisfactorily if they are used with medium heat as the manufacturer recommends.

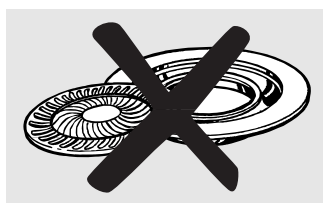

Stove Top Grills (on models with sealed burners)

Do not use stove top grills on your sealed gas burners. If you use the stove top grill on the sealed gas burner, it will cause incomplete combustion and can result in exposure to carbon monoxide levels above allowable standards.

This can be hazardous to your health.

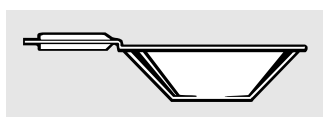

Use a flat-bottomed wok.

Wok This Way (on models with sealed burners)

We recommend that you use a 14" or smaller flat-bottomed wok. Make sure the wok bottom sits flat on the grate. They are available at your local retail store.

Only a flat-bottomed wok should be used.

Do not use a flat-bottomed wok on a support ring. Placing the ring over the burner or grate may cause the burner to work improperly, resulting in carbon monoxide levels above allowable standards. This could be dangerous to your health.

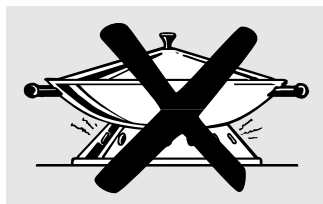

In Case of Power Failure (electric ignition models)

In case of a power failure, you can light the gas surface burners on your range with a match. Hold a lit match to the burner, then push in and turn the control knob to the **LITE** position. Use extreme caution when lighting burners this way.

Surface burners in use when an electrical power failure occurs will continue to operate normally.

Using the clock and timer.

Throughout this manual, features and appearance may vary from your model.



You have the choice of having the timer show the time counting down or the time of day. In either case, the timer will signal at the end of the timer period to alert you that the time is up.

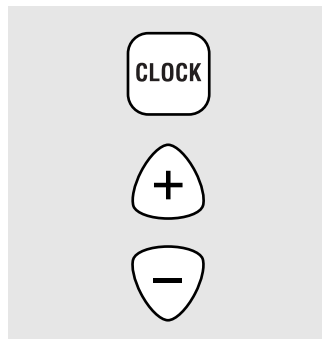

To Set the Clock

NOTE: When you first plug in the range or after a power failure, the entire Clock/Timer display will light up.

- 1 Press the **CLOCK** pad.
- 2 Press and hold the **+** or **-** pad and the time of day will change 10 minutes at a time. To change the time by single minutes, give the pads short taps.
- 3 Press the **CLOCK** pad to start the clock.

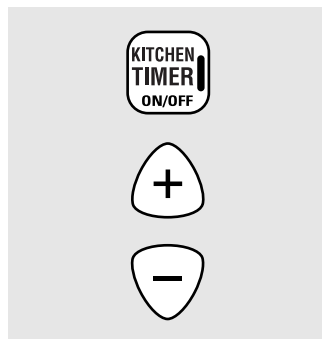

To Set the Kitchen Timer

- 1 Press the **KITCHEN TIMER ON/OFF** pad.
- 2 Use the **+** and **-** pads to set the timer. Short taps on the **+** or **-** pad change the timer's setting one minute at a time. Pressing and continuing to hold the **+** pad increases the setting 10 minutes at a time.
- 3 Once you have set your timer, press the **KITCHEN TIMER ON/OFF** pad to start timing.

As the timer counts down, a signal will indicate when one minute is left. After this signal, the display will count down in seconds. When time runs out, a final signal will sound. Press the **KITCHEN TIMER ON/OFF** pad to stop the signal.

To Change or Cancel the Kitchen Timer Setting

When the timer is counting down, use the **+** and **-** pad to change the remaining time, or press the **KITCHEN TIMER ON/OFF** pad to stop the timer. The timer cannot be cancelled unless you have fully completed "set timer" instructions above.

Display Clock While Kitchen Timer Is Operating

Pressing the **CLOCK** pad while the timer is operating will not interfere with the timer's operation; the display will change to show the clock, but the timer will continue to count down and will still signal when time is up. Press the **KITCHEN TIMER ON/OFF** pad again to change the display back to show the timer.

Using the oven.

To avoid possible burns, place the shelves in the desired position before you turn the oven on.

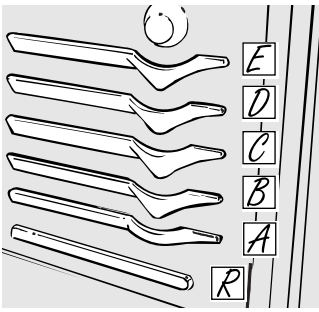

The oven has 5 shelf positions.
It also has a special low shelf position (R) for extra large items, such as a large turkey.

Before You Begin...

The shelves have stop-locks, so that when placed correctly on the shelf supports (A through E), they will stop before coming completely out, and will not tilt.

When placing and removing cookware, pull the shelf out to the bump on the shelf support.

To remove a shelf, pull it toward you, tilt the front end up and pull it out.

To replace, place the end of the shelf (stop-locks) on the support, tilt up the front and push the shelf in.

NOTE: The shelf is not designed to slide out at the special low shelf (R) position.

Oven Control

Your oven is controlled by a single **OVEN CONTROL** knob.

It will normally take 30–90 seconds before the flame comes on. After the oven reaches the selected temperature, the oven burner cycles—off completely, then on with a full flame—to maintain the selected temperature.

Oven Vent

Your oven is vented through ducts at the rear of the range. Do not block these ducts when cooking in the oven—it is important that the flow of hot air from the oven and fresh air to the oven burner be uninterrupted. Avoid touching the vent openings or nearby surfaces during oven or broiler operation—they may become hot.

- Handles of pots and pans on the cooktop may become hot if left too close to the vent.
- Do not leave plastic or flammable items on the cooktop—they may melt or ignite if left too close to the vent.
- Do not leave closed containers on the cooktop. The pressure in closed containers may increase, which may cause them to burst.
- Metal items will become very hot if they are left on the cooktop, and could cause burns.

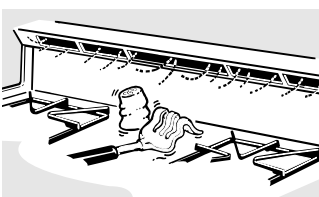

Plastic items on the cooktop may melt if left too close to the vent.
Vent appearance and location vary.

Power Outage (electric ignition models)

CAUTION: Do not make any attempt to operate the electric ignition oven during an electrical power failure.

The oven or broiler cannot be lit during a power failure. Gas will not flow unless the glow bar is hot.

If the oven is in use when a power failure occurs, the oven burner shuts off and cannot be re-lit until power is restored. This is because the flow of gas is automatically stopped and will not resume when power is restored until the glow bar has reached operating temperature.

Oven Light (on some models)

Use the switch on the **lower control panel** to turn the light on or off.

Using the oven.

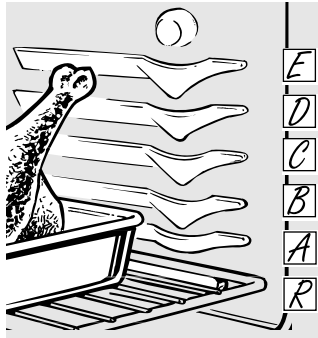

The oven has a special low shelf (R) position just above the oven bottom. Use it when extra cooking space is needed, for example, when cooking a large turkey. The shelf is not designed to slide out at this position.

How to Set the Oven for Baking or Roasting

Your oven is not designed for open-door cooking.

- 1 Close the oven door. Turn the **OVEN CONTROL** knob to the desired temperature.
- 2 Check food for doneness at minimum time on recipe. Cook longer if necessary.
- 3 Turn the **OVEN CONTROL** knob to **OFF** when baking is finished and then remove the food from the oven.

Type of Food	Shelf Position
Frozen pies (on cookie sheet)	B or C
Angel food cake, bundt or pound cakes	B
Biscuits, muffins, brownies, cookies, cupcakes, layer cakes, pies	C
Casseroles	B or C
Roasting	R or A

Preheating and Pan Placement

Preheat the oven if the recipe calls for it. To preheat, set the oven at the correct temperature. Preheating is necessary for good results when baking cakes, cookies, pastry and breads.

For ovens without a preheat indicator light or tone, preheat 10 minutes.

Baking results will be better if baking pans are centered in the oven as much as possible. Pans should not touch each other or the walls of the oven. If you need to use two shelves, stagger the pans so one is not directly above the other, and leave approximately 1½" between pans, from the front, back and sides of the wall.

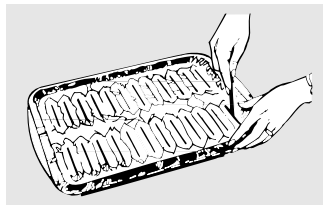

Cut slits in the foil just like the grid.

Aluminum Foil

Never cover the oven bottom with aluminum foil.

You can use aluminum foil to line the broiler pan and broiler grid. However, you must mold the foil tightly to the grid and cut slits in it just like the grid.

Aluminum foil may also be used to catch a spillover. To do so, place a small sheet of foil on a lower shelf several inches below the food.

Never entirely cover a shelf with aluminum foil. This will disturb the heat circulation and result in poor baking.

Oven Moisture

As your oven heats up, the temperature change of the air in the oven may cause water droplets to form on the door glass. These droplets are harmless and will evaporate as the oven continues to heat up.

How to Set the Oven for Broiling

Broiling is cooking food by direct heat from above the food. Most fish and tender cuts of meat can be broiled. Follow these directions to keep spattering and smoking to a minimum.

Your range has a compartment below the oven for broiling.

Both the oven and broiler compartment doors must be closed during broiling.

Turn most foods once during cooking (the exception is thin fillets of fish; oil one side, place that side down on broiler grid and cook without turning until done). Time foods for about one-half the total cooking time, turn food, then continue to cook to preferred doneness.

- 1 You can change the distance of the food from the heat source by positioning the broiler pan and grid on one of three shelf positions in the broiler compartment—A (bottom of broiler compartment), B (middle) and C (top).
- 2 Preheating the broiler or oven is not necessary and can produce poor results.

- 3 If meat has fat or gristle around the edge, cut vertical slashes through both about 2" apart. If desired, the fat may be trimmed, leaving a layer about 1/8" thick.
- 4 Arrange the food on the grid and position the broiler pan on the appropriate shelf in the oven or broiling compartment. Placing food closer to the flame increases exterior browning of the food, but also increases spattering and the possibility of fats and meat juices igniting.
- 5 Close the oven and broiler compartment door.
- 6 Turn the **OVEN CONTROL** knob to **BROIL**.
- 7 When broiling is finished, turn the **OVEN CONTROL** knob to **OFF**. Remove the broiler pan from the broiler compartment and serve the food immediately. Leave the pan outside the range to cool.

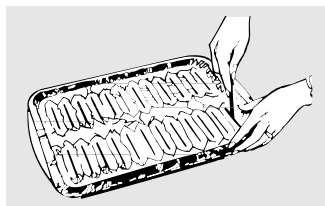

Cut slits in the foil just like the grid.

Aluminum Foil

You can use aluminum foil to line your broiler pan and broiler grid. However, you must mold the foil tightly to the grid and cut slits in it just like the grid.

Broiling Guide Suggestions

Both the oven and broiler compartment doors must be closed during broiling.

- Always use the broiler pan and grid that comes with your range. It is designed to minimize smoking and spattering by trapping juices in the shielded lower part of the pan.
- For steaks and chops, slash fat evenly around the outside edges of the meat. To slash, cut crosswise through the outer fat surface just to the edge of the meat. Use tongs to turn the meat over to prevent piercing the meat and losing juices.
- If desired, marinate meats or chicken before broiling. Or brush with barbecue sauce last 5–10 minutes only.
- When arranging the food on the pan, do not let fatty edges hang over the sides because dripping fat could soil the oven.
- The broiler compartment does not need to be preheated. However, for very thin foods, or to increase browning, preheat if desired.
- Frozen steaks can be broiled by positioning the shelf at the next lowest shelf position and increasing the cooking time given in this guide 1½ times per side.

Using the oven.

The size, weight, thickness, starting temperature and your preference of doneness will affect broiling times.

This guide is based on meats at refrigerator temperature.

†The U.S. Department of Agriculture says "Rare beef is popular, but you should know that cooking it to only 140°F means some food poisoning organisms may survive." (Source: Safe Food Book, Your Kitchen Guide, USDA Rev. June 1985.)

Broiling Guide

Food	Quantity and/or Thickness	Shelf Position	First Side Time (min.)	Second Side Time (min.)	Comments
Bacon	1/2 lb. (about 8 thin slices)	C	4	3	Arrange in single layer.
Ground Beef Well Done	1 lb. (4 patties) 1/2 to 3/4" thick	C	10	7-10	Space evenly. Up to 8 patties take about the same time.
Beef Steaks Rare† Medium Well Done	1" thick 1 to 1½ lbs.	C C B	9 12 13	7 5-6 8-9	Steaks less than 1" thick cook through before browning.
Rare† Medium Well Done	1½" thick 2 to 2½ lbs.	C C B	10 12-15 25	6-7 10-12 16-18	Slash fat.
Chicken	1 whole 2 to 2½ lbs., split lengthwise	B	30-35	15	Brush each side with melted butter. Broil skin-side-down first.
	Bone-in 4 bone-in breasts	B	25-30	10-15	
Bakery Products Bread (Toast) or Toaster Pastries English Muffins	2 to 4 slices 1 pkg. (2) 2 split	C C	2-3 3-5	1/2-1	Space evenly. Place English muffins cut-side-up and brush with butter, if desired.
Lobster Tails	2 to 4 (6 to 8 oz. each)	A	13-16	Do not turn over.	Cut through back of shell. Spread open. Brush with melted butter before broiling and after half of broiling time.
Fish	1 lb. fillets 1/4 to 1/2" thick	C	5	5	Handle and turn very carefully. Brush with lemon butter before and during cooking, if desired. Preheat broiler to increase browning.
Ham Slices (precooked)	1" thick 1/2" thick	B B	8 6	8 6	
Pork Chops Well Done	2 (1/2" thick) 2 (1" thick) about 1 lb.	B B	10 13	4-5 9-12	Slash fat.
Lamb Chops Medium Well Done	2 (1" thick) about 10 to 12 oz.	B B	8 10	4-7 10	Slash fat.
Medium Well Done	2 (1½" thick) about 1 lb.	B B	10 17	4-6 12-14	
Wieners Similar precooked sausages, bratwurst	1 lb. pkg. (10)	C	6	1-2	If desired, split sausages in half lengthwise; cut into 5" to 6" pieces.

Adjust the oven thermostat—Do it yourself!

ge.com

You may find that your new oven cooks differently than the one it replaced. Use your new oven for a few weeks to become more familiar with it. If you still think your new oven is too hot or too cold, you can adjust the thermostat yourself.

Do not use thermometers, such as those found in grocery stores, to check the temperature setting of your oven. These thermometers may vary 20–40 degrees.

NOTE: This adjustment will not affect the broiling temperatures.

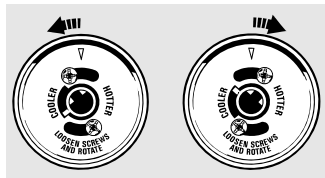

(Appearance may vary)

To Adjust the Thermostat

1 Pull the **OVEN CONTROL** knob off the range and look at the back side. To make an adjustment, loosen (approximately one turn), but do not completely remove, the two screws on the back of the knob.

2 With the back of the knob facing you, hold the outer edge of the knob with one hand and turn the front of the knob with the other hand.

To raise the oven temperature, move the top screw toward the right. You'll hear a click for each notch you move the knob.

To lower the temperature, move the top screw toward the left.

Each click will change the oven temperature approximately 10°F. (Range is $\pm 60^\circ\text{F}$. from the arrow.) We suggest that you make the adjustment one click from the original setting and check oven performance before making any additional adjustments.

3 After the adjustment is made, retighten screws so they are snug, but be careful not to overtighten.

4 Re-install knob on range and check performance.

The type of margarine will affect baking performance!

Most recipes for baking have been developed using high fat products such as butter or margarine (80% fat). If you decrease the fat, the recipe may not give the same results as with a higher fat product.

Recipe failure can result if cakes, pies, pastries, cookies or candies are made with low fat spreads. The lower the fat content of a spread product, the more noticeable these differences become.

Federal standards require products labeled “margarine” to contain at least 80% fat by weight. Low fat spreads, on the other hand, contain less fat and more water. The high moisture content of these spreads affects the texture and flavor of baked goods. For best results with your old favorite recipes, use margarine, butter or stick spreads containing at least 70% vegetable oil.

Care and cleaning of the range.

Be sure electrical power is off and all surfaces are cool before cleaning any part of the range.

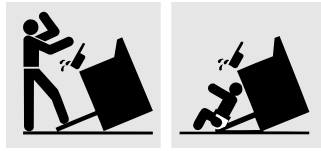

If your range is removed for cleaning, servicing or any reason, be sure the anti-tip device is re-engaged properly when the range is replaced. Failure to take this precaution could result in tipping of the range and cause injury.

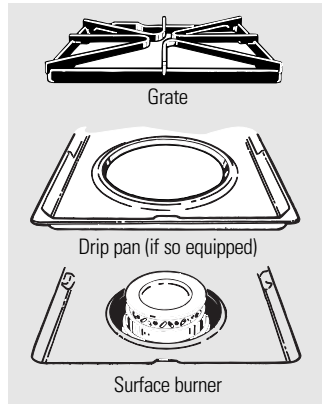

Standard Twin Burner Assemblies (on some models)

For cleaning information on sealed burners, see next section. Sealed burner cooktops do not lift up.

On models with standard twin burners, the cooktop lifts up for easy access.

Turn all controls **OFF** before removing burner parts and drip pans (if so equipped).

The burner grates and drip pans (if so equipped) can be lifted off, making them easy to clean.

The holes in the surface burners of your range must be kept clean at all times for proper ignition and an even, unhampered flame.

You should clean the surface burners routinely, especially after bad spills, which could clog these holes.

Wipe off surface burners. If heavy spillover occurs, remove the surface burners from the range. Burners lift out for cleaning. Lift up the cooktop and then lift out the surface burners.

To remove burned-on food, soak the surface burner in a solution of mild liquid detergent and hot water. Soak the surface burner for 20–30 minutes.

For more stubborn stains, use a cleanser like Soft Scrub® brand or Bon Ami® brand. Rinse well to remove any traces of the cleanser that might clog the surface burner openings.

Do not use steel wool because it will clog the surface burner openings and scratch the surface burners. If the holes become clogged, clean them with a sewing needle or twist-tie.

Before putting the surface burner back, shake out excess water and then dry it thoroughly by setting it in a warm oven for 30 minutes. Then place it back in the range, making sure it is properly seated and level.

Check the flame pattern of each burner. If the flames are “jumpy” (not steady), clean the holes again with a sewing needle or twist-tie.

CAUTION: Do not operate the cooktop without all burner parts, drip pans (if so equipped) and grates in place.

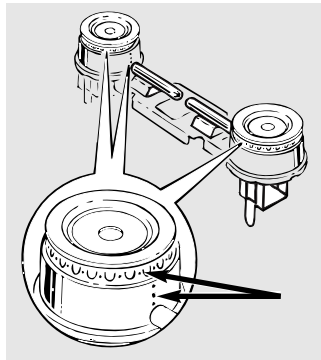

Clean these holes thoroughly on each burner.

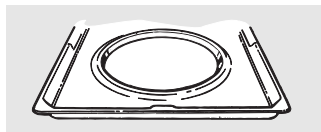

Drip Pans (if so equipped)

Remove the grates and lift out the drip pans. Drip pans can be cleaned in a dishwasher or by hand.

When replacing the drip pans, make sure they are in the correct position.

To get rid of burned-on food, place them in a covered container (or plastic bag) with 1/4 cup ammonia to loosen the soil. Then scrub with a soap-filled scouring pad if necessary.

CAUTION: Do not clean the drip pans in a self-cleaning oven.

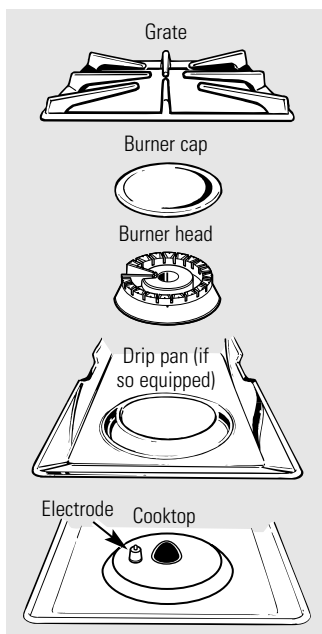

Sealed Burner Assemblies (on some models)

Turn all controls **OFF** before removing the burner parts and drip pans (if so equipped).

The burner grates, caps, burner heads and drip pans (if so equipped) can be lifted off, making them easy to clean. The electrodes are not removable.

NOTE: Do not use steel wool or scouring powders to clean the burners.

CAUTION: Do not operate the cooktop without all burner parts, drip pans (if so equipped) and grates in place.

NOTE: Do not lift the cooktop. Lifting the cooktop on sealed burner models can lead to damage and improper operation of the range.

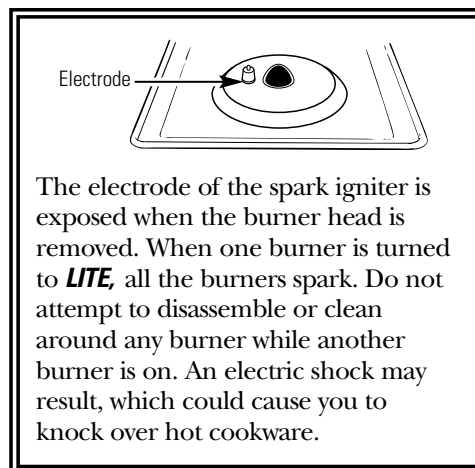

The electrode of the spark igniter is exposed when the burner head is removed. When one burner is turned to **LITE**, all the burners spark. Do not attempt to disassemble or clean around any burner while another burner is on. An electric shock may result, which could cause you to knock over hot cookware.

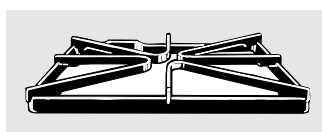

Burner Grates

Lift out when cool. Grates should be washed regularly and, of course, after spillovers. Wash them in hot, soapy water and rinse with clean water. After cleaning, dry them thoroughly by putting them in a warm oven for a few minutes. Don't put the grates back on the range while they are wet. When replacing the grates, be sure they are positioned securely over the burners.

Do not operate a burner for an extended period of time without cookware on the grate. The finish on the grate may chip without cookware to absorb the heat.

To get rid of burned-on food, place the grates in a covered container. Add 1/4 cup ammonia and let them soak several hours or overnight. Wash, rinse well and dry.

Although they are durable, the grates will gradually lose their shine, regardless of the best care you can give them. This is due to their continual exposure to high temperatures. You will notice this sooner with lighter color grates.

NOTE: Do not clean the grates in a self-cleaning oven.

Care and cleaning of the range.

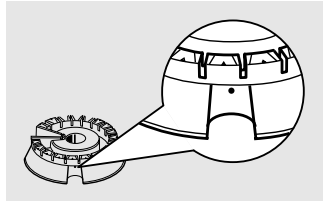

Use a sewing needle or twist-tie to unclog the small hole in the burner head.

Burner Caps and Heads (on sealed burners only)

NOTE: Before removing the burner caps and heads, remember their size and location. Replace them in the same location after cleaning.

Burner caps

Lift off when cool. Wash burner caps in hot, soapy water and rinse with clean water. You may scour with a plastic scouring pad to remove burned-on food particles.

Burner heads

For proper ignition, make sure the small hole in the section that fits over the electrode is kept open. A sewing needle or wire twist-tie works well to unclog it.

The slits in the burner heads must be kept clean at all times for an even, unhampered flame.

Clogged or dirty burner ports or electrodes will not allow the burner to operate properly.

Any spill on or around an electrode must be carefully cleaned. Take care to not hit an electrode with anything hard or it could be damaged.

You should clean the burner caps and burner heads routinely, especially after bad spillovers, which could clog the openings in the burner heads. Lift off when cool.

To remove burned-on food, soak the burner heads in a solution of mild liquid detergent and hot water for 20–30 minutes. For more stubborn stains, use a toothbrush.

After cleaning

Before putting the burner caps and heads back, shake out excess water and then dry them thoroughly by setting in a warm oven for 30 minutes.

NOTE: Do not use steel wool or scouring powders to clean the burners.

Replacement

Replace burner heads over the electrodes on the cooktop, in the correct locations according to their size.

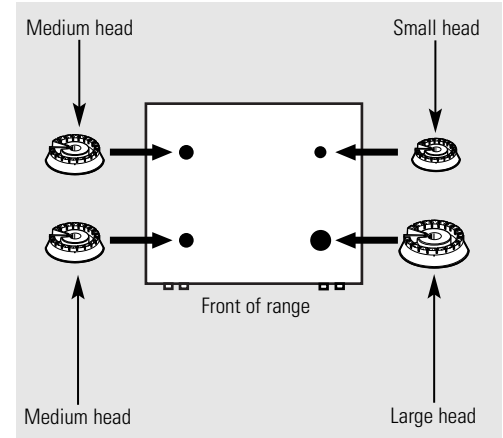

Make sure the slot in the burner head is positioned over the electrode.

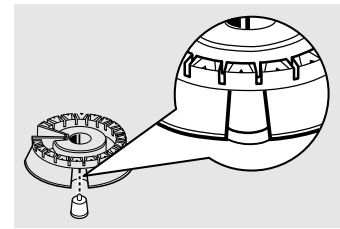

Replace the matching size caps onto the heads. There is one small, two medium and one large cap. Sizes are stamped into the bottom of the caps.

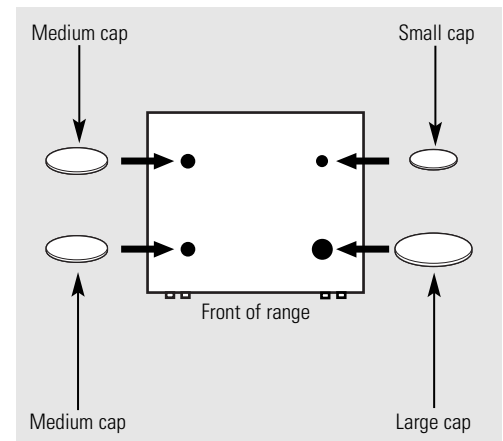

Make sure that the heads and caps are replaced in the correct locations.

NOTE: On some models, the burners are all the same size and power.

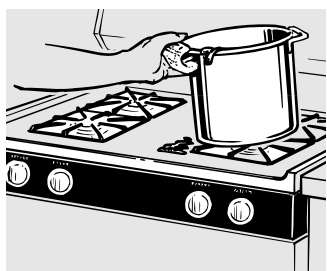

Cooktop Surface

To avoid damaging the porcelain enamel surface of the cooktop and to prevent it from becoming dull, clean up spills right away. Foods with a lot of acid (tomatoes, sauerkraut, fruit juices, etc.) or foods with high sugar content could cause a dull spot if allowed to set.

When the surface has cooled, wash and rinse. For other spills such as fat splatterings, etc., wash with soap and water once the surface has cooled. Then rinse and polish with a dry cloth.

Be careful when you clean the cooktop because the area over the pilot will be hot (on models with standing pilots).

NOTE: Do not store flammable materials in an oven or near the cooktop. Do not store or use combustible materials, gasoline or other flammable vapors and liquids in the vicinity of this or any other appliance.

NOTE: Do not lift the cooktop on sealed burner models. Lifting the cooktop can lead to damage and improper operation of the range.

Stainless Steel Surfaces (on some models)

Do not use a steel wool pad; it will scratch the surface.

To clean the stainless steel surface, use warm sudsy water or a stainless steel cleaner or polish. Always wipe the surface in the direction of the grain. Follow the cleaner instructions for cleaning the stainless steel surface.

To inquire about purchasing stainless steel appliance cleaner or polish, or to find the location of a dealer nearest you, please call our toll-free number:

National Parts Center 800.626.2002 (U.S.)
888.261.3055 (Canada)

ge.com (U.S.)
www.GEAppliances.ca (Canada)

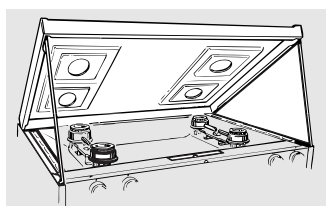

Some models have dual support rods that will hold the cooktop up while you clean underneath it.

Lift-Up Cooktop (on models with standard twin burners)

Clean the area under the cooktop often. Built-up soil, especially grease, may catch on fire.

To make cleaning easier, the cooktop may be lifted up.

NOTE: Do not lift the cooktop on sealed burner models. Lifting the cooktop can lead to damage and improper operation of the range.

To raise the cooktop:

- 1 Be sure the burners are turned off.
- 2 Remove the grates and drip pans (if so equipped).
- 3 Grasp the two front burner wells and lift up.

Clean under the cooktop with hot, soapy water and a clean cloth. If you removed your surface burners while cleaning, make sure they are properly seated when replacing them.

After cleaning, lower the cooktop (be careful not to pinch your fingers). Lower cooktop gently to avoid blowing out pilot flames (on standing pilot models).

Replace drip pans (if so equipped) and grates.

Care and cleaning of the range.

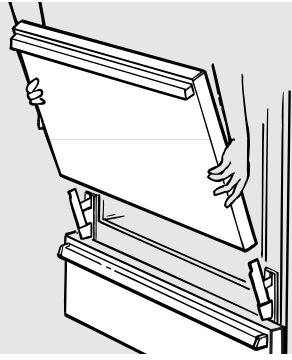

Lift the door straight up and off the hinges.

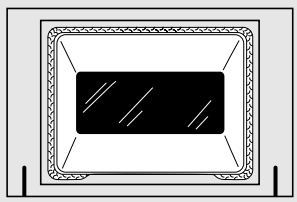

The gasket is designed with a gap at the bottom to allow for proper air circulation.

Do not rub or clean the door gasket—it has an extremely low resistance to abrasion.

If you notice the gasket becoming worn, frayed or damaged in any way or if it has become displaced on the door, you should have it replaced.

Lift-Off Oven Door

The oven door is removable, but it is heavy. You may need help removing and replacing the door.

To remove the door, open it a few inches to the special stop position that will hold the door open. Grasp firmly on each side and lift the door straight up and off the hinges.

NOTE: Be careful not to place hands between the hinge and the oven door frame as the hinge could snap back and pinch fingers.

To replace the door, make sure the hinges are in the special stop position. Position the slots in the bottom of the door squarely over the hinges. Then lower the door slowly and evenly over both hinges at the same time. If the hinges snap back against the oven frame, pull them back out.

To clean the inside of the door:

- Do not allow excess water to run into any holes or slots in the door.
- Because the area inside the gasket is cleaned during the self clean cycle, you do not need to clean this by hand. Any soap left on the liner causes additional stains when the oven is heated.
- The area outside the gasket can be cleaned with a soap-filled steel wool or plastic pad.

To clean the outside of the door:

- Use soap and water to thoroughly clean the top, sides and front of the oven door. Rinse well. You may also use a glass cleaner to clean the glass on the outside of the door.
- Spillage of marinades, fruit juices, tomato sauces and basting materials containing acids may cause discoloration and should be wiped up immediately. When the surface is cool, clean and rinse.
- Do not use oven cleaners, cleansing powders or harsh abrasives on the outside of the door.

Oven Bottom

The oven bottom has a porcelain enamel finish. To make cleaning easier, protect the oven bottom from excessive spillovers by placing a cookie sheet on the shelf below the shelf you are cooking on. This is particularly important when baking a fruit pie or other foods with a high acid content. Hot fruit fillings or other foods that are highly acidic (such as tomatoes, sauerkraut, and sauces with vinegar or lemon juice) may cause pitting and damage to the porcelain enamel surface and should be wiped up immediately.

We don't recommend using aluminum foil on the oven bottom. It can affect air flow if the holes are blocked and it can concentrate heat at the bottom of the oven, resulting in poor baking performance.

To clean up spillovers, use soap and water, an abrasive cleaner or soap-filled scouring pad. Remove the oven bottom for easier clean-up and to prevent damage to the continuous cleaning oven coating (on some models).

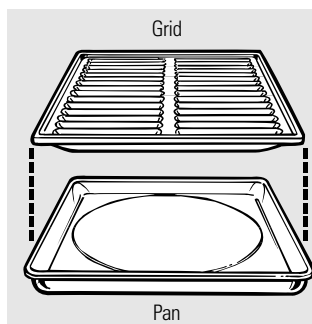

Broiler Pan and Grid

After broiling, remove the broiler pan from the oven. Remove the grid from the pan. Carefully pour out grease from the pan into a proper container. Wash and rinse the broiler pan and grid in hot water with a soap-filled or plastic scouring pad.

If food has burned on, sprinkle the grid with detergent while hot and cover with wet paper towels or a dishcloth. Soaking the pan will remove burned-on foods.

The broiler pan and grid may be cleaned with a commercial oven cleaner.

Both the broiler pan and grid can also be cleaned in a dishwasher.

Do not store a soiled broiler pan and grid anywhere in the range.

CAUTION: Do not clean the broiler pan or grid in a self-cleaning oven.

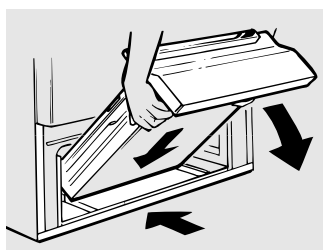

Removable Broiler Drawer (on some models)

To remove:

- 1 When the broiler is cool, remove the grid and pan.
- 2 Pull the broiler drawer out until it stops, then push it back in about one inch.
- 3 Grasp the handle, lift and pull the broiler drawer out. Clean the broiler drawer with hot soapy water.

To replace:

Hold the broiler drawer in the raised position as you slide it partway into the range. Then lower the drawer and push it completely closed.

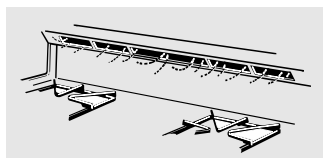

Vent appearance and location vary.

Oven Air Vents

Never block the vents (air openings) of the range. They provide the air inlet and outlet that are necessary for the range to operate properly with correct combustion.

Air openings are located at the rear of the cooktop, at the top and bottom of the oven door, and at the bottom of the range, under the kick panel or broiler drawer (depending on the model).

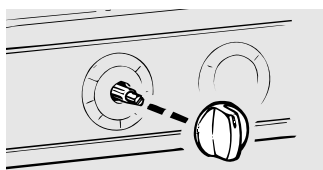

Pull the knob straight off the stem.

Lower Control Panel (Front Manifold Panel) and Knobs

It's a good idea to wipe the control panel after each use of the oven. Use a damp cloth to clean or rinse. For cleaning, use mild soap and water or a 50/50 solution of vinegar and water. For rinsing, use clean water. Polish dry with a soft cloth.

Do not use abrasive cleansers, strong liquid cleaners, plastic scouring pads or oven cleaners on the control panel—they will damage the finish.

Do not bend knobs by pulling them up or down or by hanging a towel or other such loads. This can damage the gas valve shaft.

The control knobs may be removed for easier cleaning.

Make sure the knobs are in the **OFF** positions and pull them straight off the stems for cleaning.

The knobs can be cleaned in a dishwasher or they may also be washed with soap and water. Make sure the insides of the knobs are dry before replacing.

Replace the knobs in the **OFF** position to ensure proper placement.

Metal parts can be cleaned with soap and water. Do not use steel wool, abrasives, ammonia, acids or commercial oven cleaners. Dry with a soft cloth.

Care and cleaning of the range.



Oven Shelves

Clean the shelves with an abrasive cleanser or scouring pad. After cleaning, rinse the shelves with clean water and dry with a clean cloth.

Porcelain Oven Interior (on all models except continuous-cleaning models)

With proper care, the porcelain enamel interior will retain its attractive finish for many years.

Soap and water will normally do the job. Heavy spattering or spillovers may require cleaning with a mild abrasive cleanser. Soap-filled scouring pads may also be used. Do not allow food spills with a high sugar or acid content (such as tomatoes, sauerkraut, fruit juices or pie filling) to remain on the surface. They may cause dull spots even after cleaning.

Household ammonia may make the cleaning job easier. Place 1/2 cup ammonia in a shallow glass pan and leave in a cold oven overnight. The ammonia fumes will help loosen the burned-on grease and food.

When necessary, you may use a commercial oven cleaner. Follow the package directions.

Cautions about using spray-on oven cleaners:

- Be careful where the oven cleaner is sprayed.
- Do not spray oven cleaner on the electrical controls and switches (on some models) because it could cause a short circuit and result in sparking or fire.
- Do not allow a film from the cleaner to remain on the temperature sensing bulb—it could cause the oven to heat improperly. (The bulb is located at the rear of the oven.) Carefully wipe the bulb clean after each oven cleaning, being careful not to move the bulb as a change in its position could affect how the oven bakes.
- Do not spray any oven cleaner on the outside oven door, handles or any exterior surface of the oven, cabinet or painted surfaces. The cleaner can damage these surfaces.

Special Care of Continuous-Cleaning Oven Interior (on some models)

The special coating is a porous ceramic material, which is dark in color and feels slightly rough to the touch.

The Continuous-Cleaning Oven cleans itself while cooking. The oven walls are finished with a *special coating* that cannot be cleaned in the usual manner with soap, detergents, steel wool pads, commercial oven cleaners, coarse abrasive pads or coarse brushes. Use of such cleansers and/or the use of oven sprays will cause permanent damage.

If magnified, the surface would appear as peaks, valleys and sub-surface “tunnels.” This rough finish tends to prevent grease spatters from forming little beads or droplets that run down the side walls of a hard-surface oven liner, leaving unsightly streaks that require hand cleaning. Instead, when spatter hits the porous finish, it is dispersed and partially absorbed. This spreading action increases the exposure of oven soil to heated air and makes it somewhat less noticeable.

Soil may not disappear completely and at some time after extended usage, stains may appear that cannot be removed.

The special coating works best on small amounts of spatter. It does not work well with larger spills, especially sugars, egg or dairy mixtures. The oven bottom does not have the continuous cleaning oven coating and can be removed and cleaned with a commercial oven cleaner.

This special coating is not used on the oven shelves, oven bottom or the inside of the oven door. Remove these to clean with a commercial oven cleaner to prevent damaging the Continuous-Cleaning Oven coating.

Make sure the oven bottom is in place before you turn the oven on for any reason.

Use care in removing and replacing the oven bottom and shelves and in placing and removing dishes and food to avoid scratching, rubbing or otherwise damaging the porous finish on the oven walls.

To Clean the Continuous-Cleaning Oven:

- 1 Let range parts cool before handling. We recommend rubber gloves be worn when cleaning.
- 2 Remove shelves and cookware.

- 3 Soil visibility may be reduced by operating the oven at 400°F. Close the door and turn the **OVEN CONTROL** knob to 400°F. Time for at least four hours. Repeated cycles may be necessary before improvement in appearance is apparent.

REMEMBER: During the operation of the oven, the door and other range surfaces will get hot enough to cause burns. Do not touch. Let the range cool before replacing the oven shelves.

- 4 If a spillover or heavy soiling occurs on the porous surface, as soon as the oven has cooled, remove as much of the soil as possible using a small amount of water and a stiff-bristle nylon brush. Use water sparingly and change it frequently, keeping it as clean as possible, and be sure to blot it up with paper towels, cloths or sponges. Do not rub or scrub with paper towels, cloths or sponges, since they will leave unsightly lint on the oven finish. If water leaves a white ring on the finish as it dries, apply water again and blot it with a clean sponge, starting at the edge of the ring and working toward the center.

The oven bottom has a porcelain enamel finish. The oven bottom comes out for cleaning away from the Continuous-Cleaning Oven.

The inside of the oven door has a porcelain enamel finish. The oven door lifts off for cleaning away from the Continuous-Cleaning Oven. For instructions on how to clean the inside of the oven door refer to the Lift-Off Oven Door section.

Do not use soap, detergent, steel wool pads, commercial oven cleaner, silicone oven sprays, coarse pads or coarse brushes on the porous surface. These products will spot, clog and damage the porous surface and reduce its ability to work.

Do not scrape the porous surface with a knife or spatula—they could permanently damage the finish.

Installation Instructions

Range

If you have questions, call 800.GE.CARES or visit our Website at: ge.com

IN THE COMMONWEALTH OF MASSACHUSETTS

- This product must be installed by a licensed plumber or gas fitter.
- When using ball-type gas shut-off valves, they shall be the T-handle type.
- A flexible gas connector, when used, must not exceed 3 feet.

BEFORE YOU BEGIN

Read these instructions completely and carefully.

Installation of this range must conform with local codes, or in the absence of local codes, with the National Fuel Gas Code, ANSI Z223.1/NFPA.54, latest edition. In Canada, installation must conform with the current Natural Gas Installation Code, CAN/CGA-B149.1 or the current Propane Installation Code, CAN/CGA-B149.2, and with local codes where applicable. This range has been design-certified by CSA International according to ANSI Z21.1, latest edition and Canadian Gas Association according to CAN/CGA-1.1 latest edition.

As with any appliance using gas and generating heat, there are certain safety precautions you should follow. You will find these precautions in the *Important Safety Information* section in the front of this manual. Read them carefully.

- **IMPORTANT** — Save these instructions for local inspector's use.
- **IMPORTANT** — Observe all governing codes and ordinances.
- **Note to Installer** – Be sure to leave these instructions with the Consumer.
- **Note to Consumer** – Keep these instructions for future reference.
- **Note** – This appliance must be properly grounded.
- **Servicer** – The electrical diagram is in an envelope attached to the back of the range.
- **Skill Level** – Installation of this appliance requires basic mechanical skills.
- Proper installation is the responsibility of the installer.
- Product failure due to improper installation is not covered under the Warranty.

Installation Instructions

FOR YOUR SAFETY

Do not store or use combustible materials, gasoline or other flammable vapors and liquids in the vicinity of this or any other appliance. If you smell gas:

- 1 Open windows.
- 2 Don't touch electrical switches.
- 3 Extinguish any open flame.
- 4 Immediately call your gas supplier.

TOOLS YOU WILL NEED

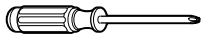

Phillips screwdriver



Flat-blade screwdriver
3/16" or smaller

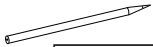

Pencil and ruler



Level



Open-end or
adjustable wrench

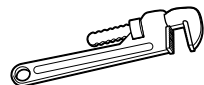

Pipe wrenches (2)
(one for backup)



Drill, awl or nail

MATERIALS YOU MAY NEED

- Gas line shut-off valve
- Pipe joint sealant or UL-approved pipe thread tape with Teflon* that resists action of natural and LP gases
- Flexible metal appliance connector (1/2" I.D.)
A 5-foot length is recommended for ease of installation but other lengths are acceptable. Never use an old connector when installing a new range.
- Flare union adapter for connection to gas supply line (3/4" or 1/2" NPT x 1/2" I.D.).
- Flare union adapter for connection to pressure regulator on range (1/2" NPT x 1/2" I.D.)
- Liquid leak detector or soapy water.
- Lag bolt or 1/2" O.D. sleeve anchor (for concrete floors only).
- Long matches and/or match holder (for models equipped with standing pilots).

*Teflon: Registered trademark of DuPont

PART INCLUDED

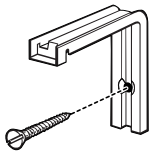

Anti-tip bracket kit

Installation Instructions

⚠ WARNING! **INSTALLATION SAFETY INSTRUCTIONS**

Read these instructions completely and carefully.

Improper installation, adjustment, alteration, service or maintenance can cause injury or property damage. Refer to this manual. For assistance or additional information, consult a qualified installer, service agency, manufacturer (dealer) or the gas supplier.

Never reuse old flexible connectors. The use of old flexible connectors can cause gas leaks and personal injury. Always use **NEW** flexible connectors when installing a gas appliance.

IMPORTANT — Remove all packing material and literature from oven before connecting gas and electrical supply to range.

CAUTION — Do not attempt to operate the oven of this range during a power failure (Electric Ignition models only).

- Have your range installed by a qualified installer.
- Your range must be electrically grounded in accordance with local codes or, in the absence of local codes, in accordance with the National Electrical Code (ANSI/NFPA 70, latest edition). In Canada, electrical grounding must be in accordance with the current CSA C22.1 Canadian Electrical Code Part 1 and/or local codes. See *Electrical Connections* in this section.
- Before installing your range on linoleum or any other synthetic floor covering, make sure the floor covering can withstand 180°F without shrinking, warping or discoloring. Do not install the range over carpeting unless a sheet of 1/4" thick plywood or similar insulator is placed between the range and carpeting.
- Make sure the wall coverings around the range can withstand heat generated by the range up to 200°F.

- Avoid placing cabinets above the range. To reduce the hazard caused by reaching over the open flames of operating burners, install a ventilation hood over the range that projects forward at least 5" beyond the front of the cabinets.
- The ventilating hood must be constructed of sheet metal not less than 0.0122" thick. Install above the cooktop with a clearance of not less than 1/4" between the hood and the underside of the combustible material or metal cabinet. The hood must be at least as wide as the appliance and centered over the appliance. Clearance between the cooking surface and the ventilation hood surface **MUST NEVER BE LESS THAN 24 INCHES.**

EXCEPTION: Installation of a listed microwave oven or cooking appliance over the cooktop shall conform to the installation instructions packed with that appliance.

- If cabinets are placed above the range, allow a minimum clearance of 30" between the cooking surface and the bottom of unprotected cabinets.
- If a 30" clearance between cooking surface and overhead combustible material or metal cabinets cannot be maintained, protect the underside of the cabinets above the cooktop with not less than 1/4" insulating millboard covered with sheet metal not less than 0.0122" thick. Clearance between the cooking surface and protected cabinets **MUST NEVER BE LESS THAN 24 INCHES.**
- The vertical distance from the plane of the cooking surface to the bottom of adjacent overhead cabinets extending closer than 1" to the plane of the range sides must not be less than 18". (See the *Dimensions and Clearances* illustration in this section.)
- **CAUTION** — Items of interest to children should not be stored in cabinets above a range or on the backsplash of a range—children climbing on the range to reach items could be seriously injured.

Installation Instructions

DIMENSIONS AND CLEARANCES

Provide adequate clearances between the range and adjacent combustible surfaces. These dimensions must be met for safe use of your range. The location of the electrical outlet and pipe opening (see *Gas Pipe and Electric Outlet Locations*) may be adjusted to meet specific requirements.

The range may be placed with 0" clearance (flush) at the back wall.

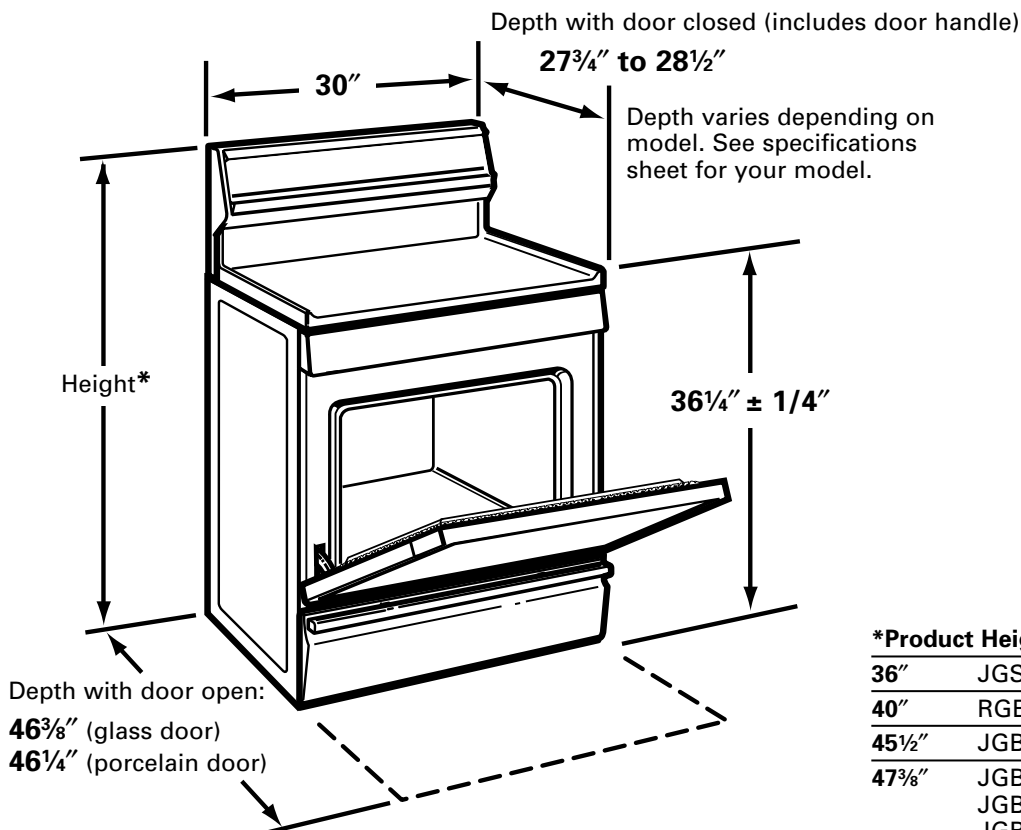
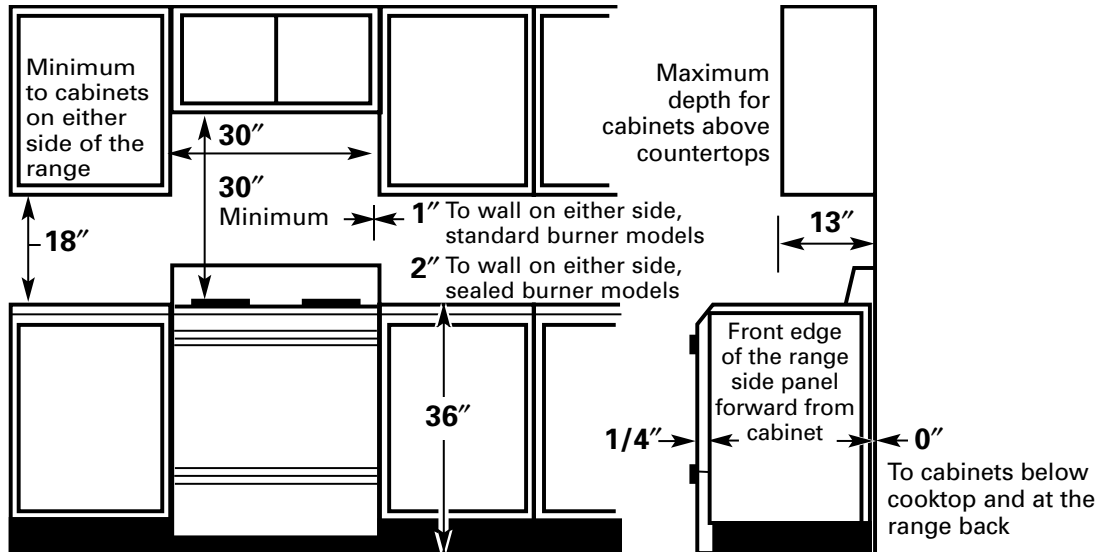

*Product Height:

36"	JGSS05		
40"	RGB508		
45 ¹ / ₂ "	JGBS04	JGBS07	RGB524
47 ³ / ₈ "	JGBC20	JGBS21	RGB528
	JGBS17	JGBS22	RGB533
	JGBS20	JGBS23	RGB540

Installation Instructions

⚠ WARNING! **ANTI-TIP DEVICE**



All ranges can tip and injury could result.



To prevent accidental tipping of the range, attach an approved Anti-Tip device to the wall. (See *Installing the Anti-Tip Device* in this section.) To check if the device is installed and engaged properly, carefully tip the range forward. The Anti-Tip device should engage and prevent the range from tipping over.

If you pull the range out from the wall for any reason, make sure the Anti-Tip device is engaged when you push the range back against the wall.

- For your safety, never use your range for warming or heating the room. Your oven and cooktop are not designed to heat your kitchen. Top burners should not be operated without cookware on the grate. Such abuse could result in fire and damage to your range and will void your warranty.
- Do not store or use combustible materials, gasoline or other flammable vapors and liquids in the vicinity of this or any other appliance. Explosions or fires could result.
- Do not use oven for a storage area. Items stored in the oven can ignite.
- Do not let cooking grease or other flammable materials accumulate in or near the range.

LOCATION

Do not locate the range where it may be subject to strong drafts. Any openings in the floor or wall behind the range should be sealed. Make sure the openings around the base of the range that supply fresh air for combustion and ventilation are not obstructed by carpeting or woodwork.

Your range, like many other household items, is heavy and can settle into soft floor coverings such as cushioned vinyl or carpeting. Use care when moving the range on this type of flooring. It is recommended that the following simple and inexpensive instructions be followed to protect your floor.

The range should be installed on a sheet of plywood (or similar material). When the floor covering ends at the front of the range, the area that the range will rest on should be built up with plywood to the same level or higher than the floor covering.

This will allow the range to be moved for cleaning or servicing. Also, make sure your floor covering will withstand 180°F. (See the *Installation Safety Instructions* section.)

Make sure the wall coverings around your range can withstand the heat generated (up to 200°F) by the range. (See the *Installation Safety Instructions* section.)

MODEL AND SERIAL NUMBER LOCATION

Depending on your range, you'll find the model and serial numbers on a label on the front frame of the range, behind the kick panel or broiler drawer.

IMPORTANT!

Remove all tape and packaging. Make sure the burners are properly seated and level.

Lift up the cooktop (on models with standard twin burners) and remove any packing material under it.

Take the accessory pack out of the oven and/or drawer.

Check to be sure that no range parts have come loose during shipping.

Installation Instructions

1 PROVIDE ADEQUATE GAS SUPPLY

Your range is designed to operate at a pressure of 4" of water column on natural gas or, if designed for LP gas (propane or butane), 10" of water column.

Make sure you are supplying your range with the type of gas for which it is designed.

This range is convertible for use on natural or propane gas. If you decide to use this range on LP gas, conversion must be made by a qualified LP installer before attempting to operate the range on that gas.

For proper operation, the pressure of natural gas supplied to the regulator must be between 4" and 13" of water column.

For LP gas, the pressure supplied must be between 10" and 13" of water column.

When checking for proper operation of the regulator, the inlet pressure must be at least 1" greater than the operating (manifold) pressure as given above.

The pressure regulator located at the inlet of the range manifold must remain in the supply line regardless of whether natural or LP gas is being used.

A flexible metal appliance connector used to connect the range to the gas supply line should have an I.D. of 1/2" and be 5 feet in length for ease of installation. In Canada, flexible connectors must be single wall metal connectors no longer than 6 feet in length.

2 CONNECT THE RANGE TO GAS

Shut off the main gas supply valve before disconnecting the old range and leave it off until the new hookup has been completed. Don't forget to relight the pilot on other gas appliances when you turn the gas back on.

Because hard piping restricts movement of the range, the use of a CSA International-certified flexible metal appliance connector is recommended unless local codes require a hard-piped connection.

Never use an old connector when installing a new range. If the hard piping method is used, you must carefully align the pipe; the range cannot be moved after the connection is made.

To prevent gas leaks, put pipe joint compound on, or wrap pipe thread tape with Teflon* around, all male (external) pipe threads.

- A** Install a manual gas line shut-off valve in the gas line in an easily accessed location outside of the range. Make sure everyone operating the range knows where and how to shut off the gas supply to the range.
- B** Install male 1/2" flare union adapter to the 1/2" NPT internal thread at inlet of regulator. Use a backup wrench on the regulator fitting to avoid damage.
- C** Install male 1/2" or 3/4" flare union adapter to the NPT internal thread of the manual shut-off valve, taking care to back-up the shut-off valve to keep it from turning.
- D** Connect flexible metal appliance connector to the adapter on the range. Position range to permit connection at the shut-off valve.
- E** When all connections have been made, make sure all range controls are in the off position and turn on the main gas supply valve. Use a liquid leak detector at all joints and connections to check for leaks in the system.

WARNING — DO NOT USE A FLAME TO CHECK FOR GAS LEAKS.

When using test pressures greater than 1/2 psig to pressure test the gas supply system of the residence, disconnect the range and individual shut-off valve from the gas supply piping. When using test pressures of 1/2 psig or less to test the gas supply system, simply isolate the range from the gas supply system by closing the individual shut-off valve.

*Teflon: Registered trademark of DuPont

Installation Instructions

GAS PIPE AND ELECTRICAL OUTLET LOCATIONS (for models with Sealed Burners)

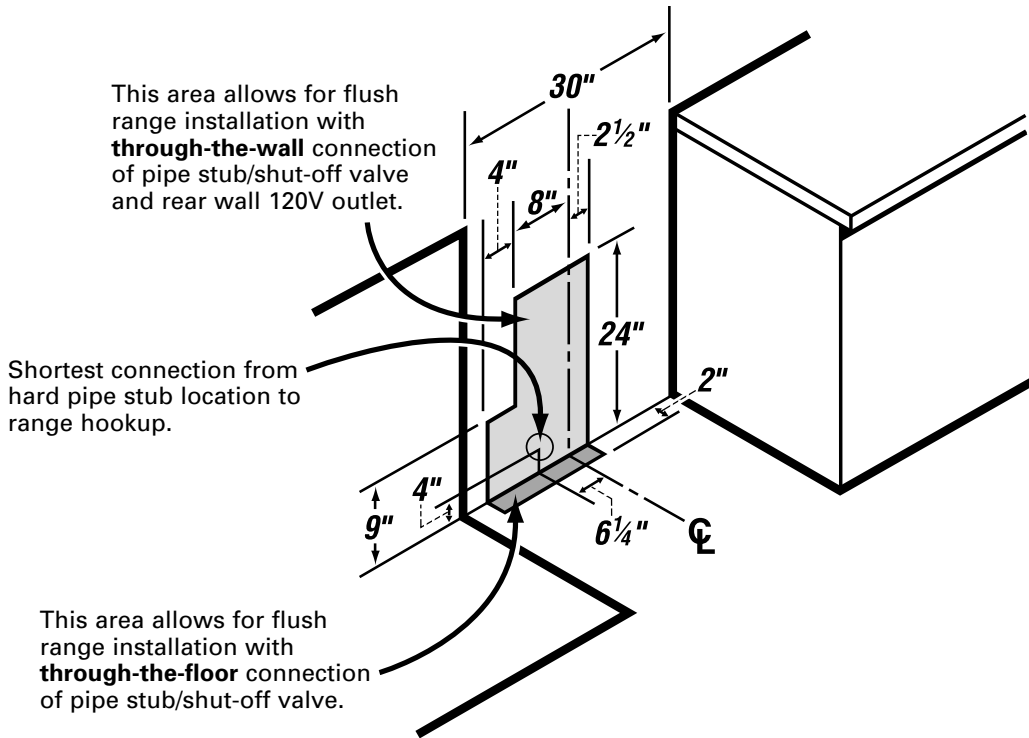

GAS PIPE AND ELECTRICAL OUTLET LOCATIONS (for models with Standard Twin Burners)

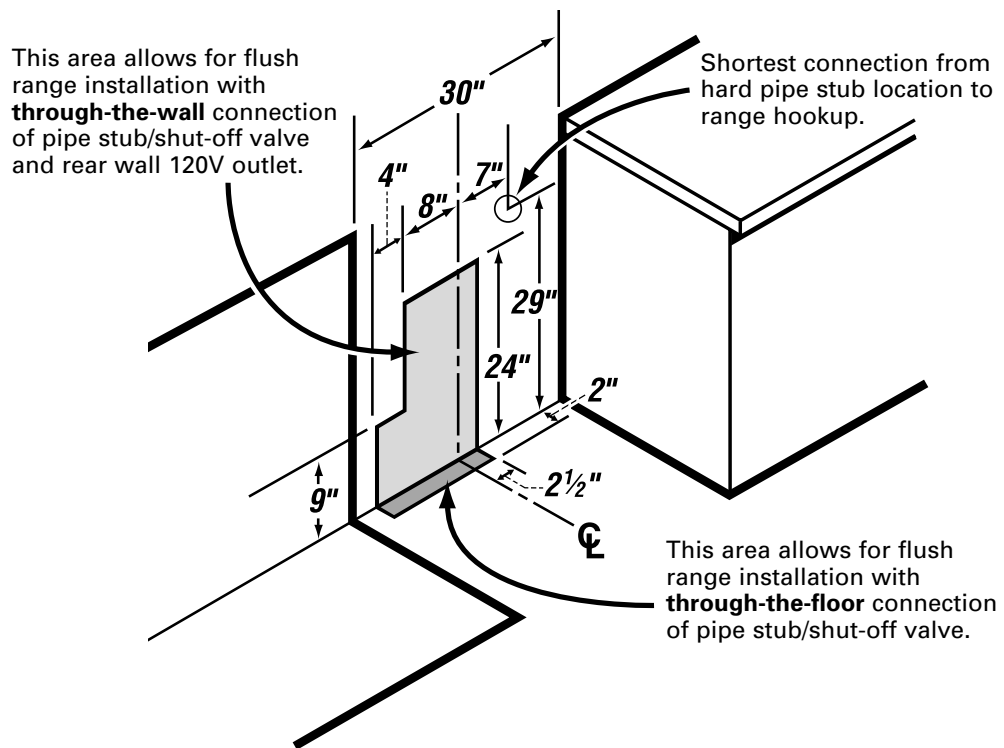

Installation Instructions

FLEXIBLE CONNECTOR HOOKUP (for models equipped with Sealed Burners)

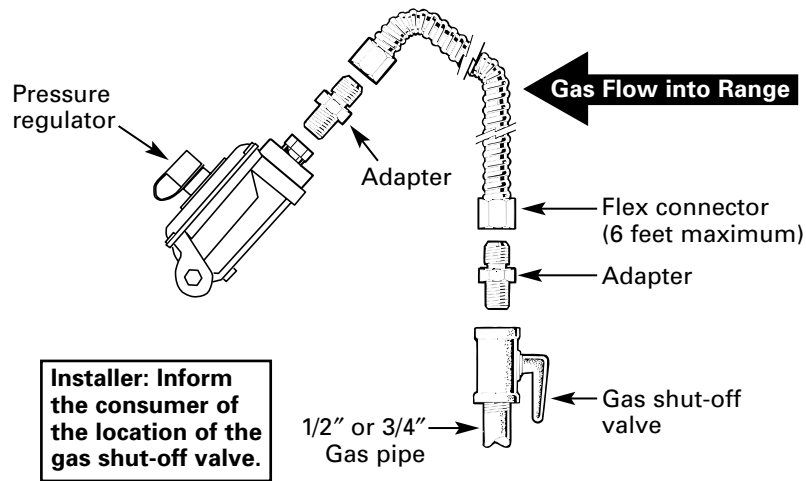

RIGID PIPE HOOKUP OPTIONS (for models equipped with Sealed Burners)

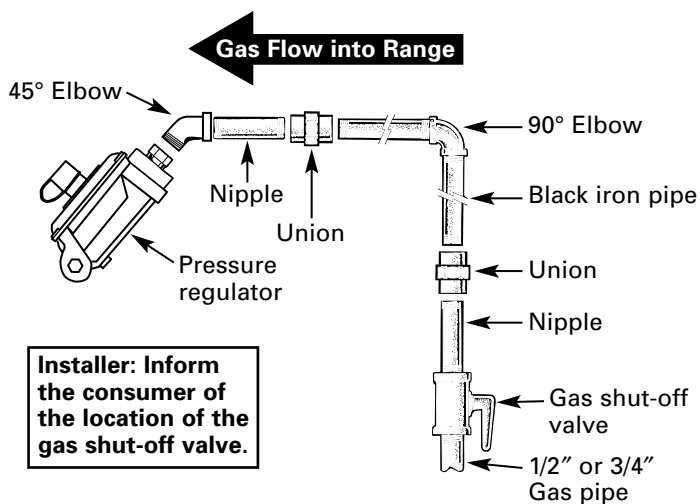

Alternate Hookup

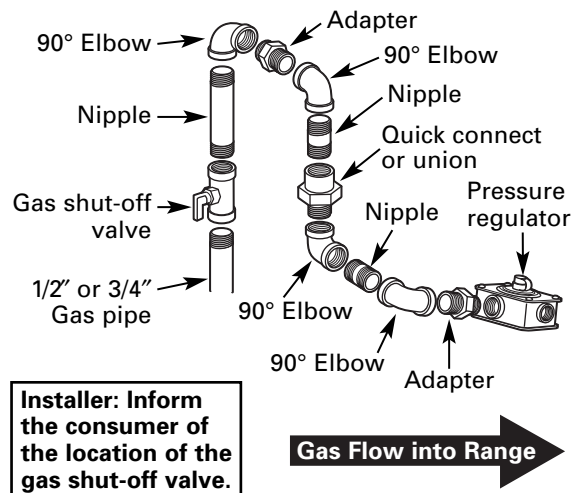

Installation Instructions

FLEXIBLE CONNECTOR HOOKUP (for models equipped with Standard Twin Burners)

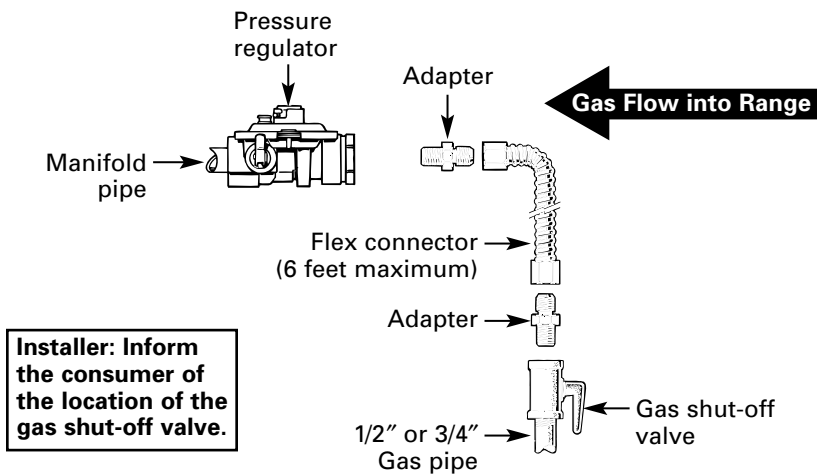

RIGID PIPE HOOKUP (for models equipped with Standard Twin Burners)

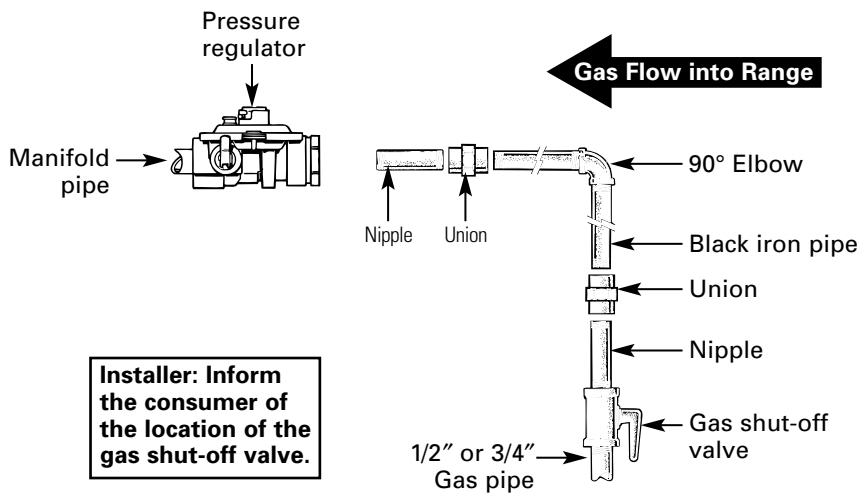

Installation Instructions

3 ELECTRICAL CONNECTIONS

Electrical Requirements

120-volt, 60 Hertz, properly grounded branch circuit protected by a 15-amp or 20-amp circuit breaker or time delay fuse.

Extension Cord Cautions

Because of potential safety hazards associated with certain conditions, we strongly recommend against the use of an extension cord. However, if you still elect to use an extension cord, it is absolutely necessary that it be a UL-listed, 3-wire grounding-type appliance extension cord and that the current carrying rating of the cord in amperes be equivalent to, or greater than, the branch circuit rating.

Grounding

IMPORTANT—(Please read carefully) FOR PERSONAL SAFETY, THIS APPLIANCE MUST BE PROPERLY GROUNDED.

Preferred Method

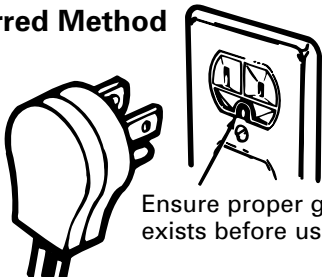

Ensure proper ground exists before use

The power cord of this appliance is equipped with a 3-prong (grounding) plug which mates with a standard 3-prong grounding wall receptacle to minimize the possibility of electric shock hazard from this appliance.

The customer should have the wall receptacle and circuit checked by a qualified electrician to make sure the receptacle is properly grounded.

Where a standard 2-prong wall receptacle is encountered, it is the personal responsibility and obligation of the customer to have it replaced with a properly grounded 3-prong wall receptacle.

DO NOT, UNDER ANY CIRCUMSTANCES, CUT OR REMOVE THE THIRD (GROUND) PRONG FROM THE POWER CORD.

A word about GFCI's—GFCI's are not required or recommended for gas range receptacles.

Ground Fault Circuit Interrupters (GFCI's) are devices that sense leakage of current in a circuit and automatically switch off power when a threshold leakage level is detected. These devices must be manually reset by the consumer. The National Electrical Code requires the use of GFCI's in kitchen receptacles installed to serve countertop surfaces. Performance of the range will not be affected if operated on a GFCI-protected circuit but occasional nuisance tripping of the GFCI breaker is possible.

A Usage Situations where Appliance Power Cord will be Disconnected Infrequently.

An adapter may be used only on a 15-amp circuit. Do not use an adapter on a 20-amp circuit. Where local codes permit, a **TEMPORARY CONNECTION** may be made to a properly grounded two-prong wall receptacle by the use of a UL-listed adapter, available at most hardware stores. The larger slot in the adapter must be aligned with the larger slot in the wall receptacle to provide proper polarity in the connection of the power cord.

Temporary Method

(Adapter plugs not permitted in Canada)

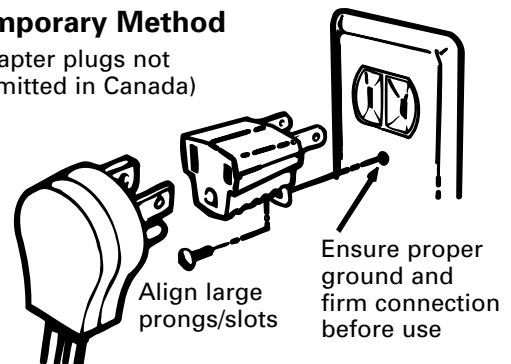

CAUTION — Attaching the adapter ground terminal to the wall receptacle cover screw does not ground the appliance unless the cover screw is metal, and not insulated, and the wall receptacle is grounded through the house wiring. The customer should have the circuit checked by a qualified electrician to make sure the receptacle is properly grounded.

Installation Instructions

3 ELECTRICAL CONNECTIONS (cont.)

When disconnecting the power cord from the adapter, always hold the adapter with one hand. If this is not done, the adapter ground terminal is very likely to break with repeated use. Should this happen, **DO NOT USE** the appliance until a proper ground has again been established.

B Usage Situations where Appliance Power Cord will be Disconnected Frequently.

Do not use an adapter plug in these situations because disconnecting of the power cord places undue strain on the adapter and leads to eventual failure of the adapter ground terminal. The customer should have the 2-prong wall receptacle replaced with a three-prong (grounding) receptacle by a qualified electrician before using the appliance.

The installation of appliances designed for mobile home installation must conform with the Manufactured Home Construction and Safety Standard, Title 24 CFR, Part 3280 (formerly the Federal Standard for Mobile Home Construction and Safety, Title 24, HUD, Part 280) or, when such standard is not applicable, the Standard for Manufactured Home Installations, latest edition (Manufactured Home Sites, Communities and Set-Ups), ANSI A225.1, latest edition, or with local codes. In Canada, mobile home installation must be in accordance with the current CAN/CSA Z240/MH Mobile Home Installation Code.

Electric Disconnect

- Locate disconnect plug on the range back.
- Pinch sides of connector and pull out of range back.

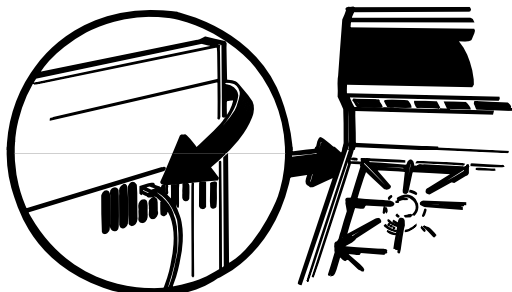

4 SEAL THE OPENINGS

Seal any openings in the wall behind the range and in the floor under the range when hookups are completed.

5 LIGHT THE PILOTS

(For models equipped with standing pilots. If the range is an electric ignition model, the burners are ignited by electric ignition which eliminates the need for standing pilot lights.)

The range should be installed in its permanent position before any pilots are lit or adjusted.

CAUTION — Make sure the surface burner control knobs are in the **OFF** position before attempting to light the pilots.

A Light the Surface Burner Pilots

1. Raise the cooktop.
2. Light both pilots with a match.
3. To avoid pilot outage, use caution when closing cooktop after lighting pilots.

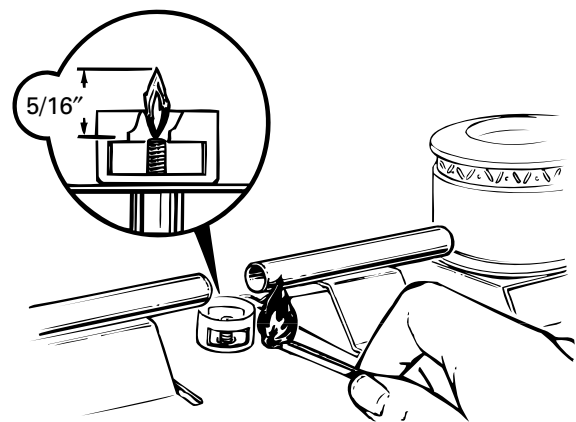

NOTE: Do not leave standing pilot lit in a newly constructed or remodeled home or apartment that will be unoccupied for more than a month.

Each pilot flame was adjusted at the factory to be approximately 5/16" tall. A tinge of yellow appearing at the upper tip is normal. If you find pilot adjustment is necessary, follow instructions in Step B.

Installation Instructions

5 LIGHT THE PILOTS (cont.)

B Adjust the Surface Burner Pilots if Necessary

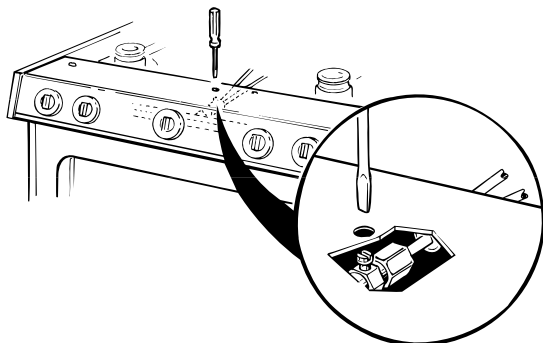

CAUTION — Make sure the surface burner control knobs are in the **OFF** position before attempting to adjust the pilots.

1. Raise the cooktop.
2. Locate the pilot adjustment screw. It can be accessed through the small hole near the center of the manifold panel.
3. To adjust, use a blade-type screwdriver with a shaft diameter of less than or equal to 3/16". Turn pilot adjustment screw until pilot flame is 5/16" high. Do not reduce the flame to less than 5/16" or pilot outage may occur. A pilot flame burning higher than recommended may generate soot (carbon black) on the bottom of your cooktop.

C Light the Oven Pilot

1. Ensure the top burners are lit before attempting to light the oven pilot (turn them off after you have lit the oven pilot).
2. Remove the oven door. See *Lift-Off Oven Door* in the *Care and cleaning of range* section.
3. Remove the oven shelves.

C Light the Oven Pilot (cont.)

4. Remove the oven bottom. To remove:

- Remove knurled screws holding down rear of oven bottom.
- Grasp oven bottom at finger slots on each side.
- Lift rear of oven bottom enough to clear the lip of range frame, then pull out.

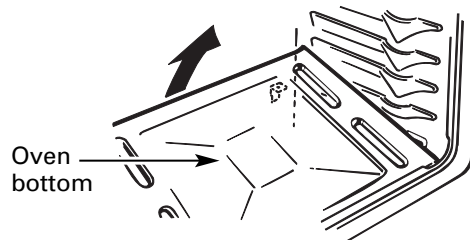

5. Locate the pilot in the back of the oven bottom. The pilot is attached to the left side of the oven burner.

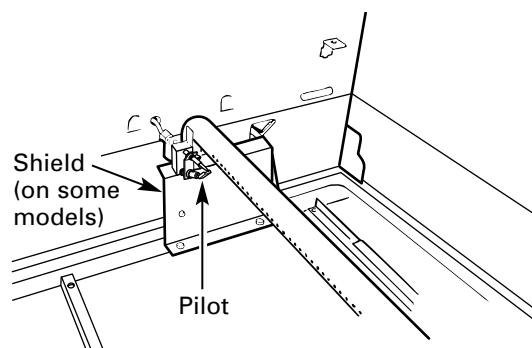

6. To light the oven pilot, push in and hold the oven control knob while lighting the pilot with a long match or match holder. Once the oven pilot is lit, continue holding the oven control knob for one minute before releasing.

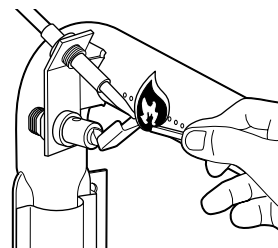

No adjustments are required for natural gas. If the range is connected to LP gas, contact the person who installed your range or made the conversion. If pilot flame does not stay lit, repeat this step.

Installation Instructions

5 LIGHT THE PILOTS (cont.)

D Check Ignition of Oven Burner

The oven is designed to operate quietly and automatically. To operate the oven, turn the **OVEN CONTROL** knob to a setting above **260°F**. After 30–90 seconds, the oven burner will ignite and burn until the set temperature is reached. The oven burner will continue to cycle on and off as necessary to maintain the oven at the temperature indicated by the **OVEN CONTROL** knob.

Electric ignition models require electrical power to operate. In case of a power outage, the oven burners on these models cannot be lit manually with a match. Gas will not flow unless the glow bar is hot.

If the oven is in use when a power outage occurs, the burner will shut off and cannot be re-lit until power is restored.

E Adjust Broil Burner Air Adjustment Shutter on Models with a Broiler Drawer, if Necessary

Determine if the bottom burner flames are burning properly.

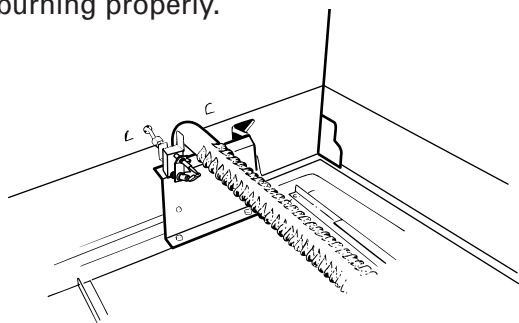

With the oven bottom removed, properly adjusted flames should have approximately 1" blue cones and, if range is supplied with natural gas, should burn with no yellow tipping. (With most LP gas, small yellow tips at the end of outer cones are normal.) Flames should not lift off burner ports. If lifting is observed, gradually reduce air shutter opening until flames are stabilized.

The shutter for the oven burner is near the back wall of the oven and behind the broiler drawer.

E Adjust Broil Burner Air Adjustment Shutter on Models with a Broiler Drawer, if Necessary (cont.)

To Remove the Broiler Drawer:

1. Pull the drawer out until it stops, then push it back in about one inch.
2. Grasp handle, lift and pull broiler drawer out.

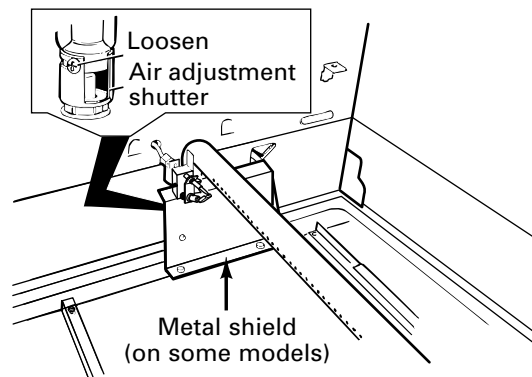

On some models, remove the metal shield at the rear of the cavity.

To adjust the flow of air to the burner, loosen the Phillips-head screw and rotate the shutter to allow more or less air into the burner tube.

Installation Instructions

5 LIGHT THE PILOTS (cont.)

F Check Ignition of Surface Burners

Operation of all cooktop and oven burners should be checked after pilots have been lighted (on some models) and the range and gas supply lines have been carefully checked for leaks.

Standing Pilot Models

Select a top burner knob and simultaneously push in and turn to **HI** position. The burner should light within a few seconds. Try each burner in succession until all burners have been checked.

Electric Ignition Models

Select a top burner knob and simultaneously push in and turn to **LITE** position. You will hear a *clicking* sound indicating proper operation of the spark module. Once the air has been purged from the supply lines, burners should light within 4 seconds. After burner lights, rotate knob out of the **LITE** position. Try each burner in succession until all burners have been checked.

Quality of Flames

The combustion quality of burner flames needs to be determined visually.



(A) Yellow flames—
Call for service

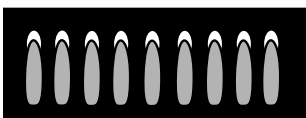

**(B) Yellow tips on
outer cones—**
Normal for LP gas



**(C) Soft blue
flames—Normal**
for natural gas

If burner flames look like (A), call for service. Normal burner flames should look like (B) or (C), depending on the type of gas you use.

With LP gas, some yellow tipping on outer cones is normal.

G Replace Oven Parts

After all adjustments are made, replace the broiler drawer, oven bottom, shelves and oven door.

Installation Instructions

6 LEVEL THE RANGE

- A** Install the oven shelves in the oven and position the range where it will be installed.

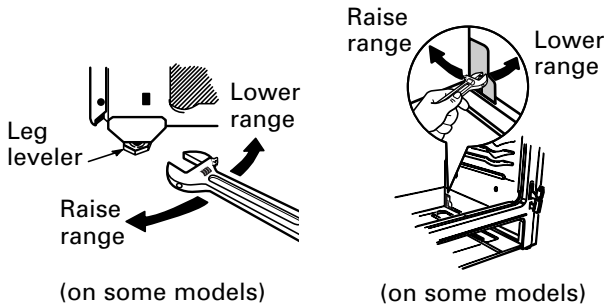

- B** Check for levelness by placing a spirit level or a cup, partially filled with water, on one of the oven shelves. If using a spirit level, take two readings—with the level placed diagonally first in one direction and then the other.
- C** Remove the broiler drawer or kick panel. See the *Care and cleaning of the range* section. The front leveling legs can be adjusted from the bottom and the rear legs can be adjusted from the top or the bottom.
- D** Use an open-end or adjustable wrench to adjust the leveling legs until the range is level.
- E** After the range is level, slide the range away from the wall so that the Anti-Tip device can be installed.

7 INSTALL THE ANTI-TIP DEVICE

WARNING —

- Range must be secured with an approved Anti-Tip device.
- Unless properly installed, the range could be tipped by you or a child standing, sitting or leaning on an open door.
- After installing the Anti-Tip device, verify that it is in place by carefully attempting to tilt the range forward.
- This range has been designed to meet all recognized industry tip standards for all normal conditions.
- The use of this device does not preclude tipping of the range when not properly installed.
- If the Anti-Tip device supplied with the range does not fit this application, use the universal Anti-Tip device WB2X7909.

- A** Mark the wall where the **RIGHT EDGE** of the range is to be located. Be sure to allow for the countertop overhang if you intend to install the range next to cabinets.

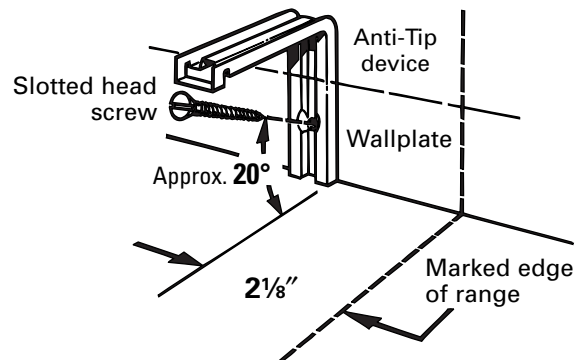

- B** Locate the outside edge of the device 2 1/8" toward the center of the range from the marked edge of the range.
- C** Using the device as a template, mark the position of the hole for the screw.

Installation Instructions

7 INSTALL THE ANTI-TIP DEVICE (cont.)

- D** For wood construction, drill a pilot hole at an angle of 20° from the horizontal. A nail or awl may be used if a drill is not available.

Mount the Anti-Tip device with the screw provided.

For cement or concrete construction, you will need a 1/4" x 1 1/2" lag bolt and a 1/2" O.D. sleeve anchor, which are not provided. Drill the recommended size hole for the hardware.

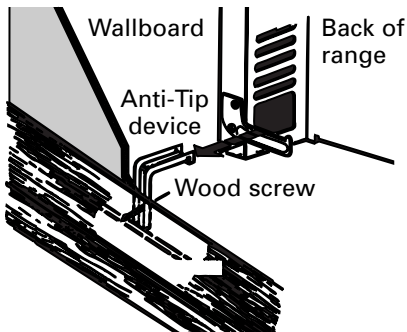

Install the sleeve anchor into the drilled hole and then install the lag bolt through the device. The bolts must be properly tightened as recommended for the hardware.

- E** Slide the range against the wall, and check for proper installation by grasping the front edge of the cooktop and carefully attempting to tilt the range forward.

WHEN ALL HOOKUPS ARE COMPLETED

Make sure all controls are left in the OFF position. Make sure the flow of combustion and ventilation air to the range is unobstructed.

CONVERT TO LP GAS (or convert back to natural gas from LP)

This range leaves the factory set for use with natural gas. If you want to convert to LP gas, the conversion must be performed by a qualified LP gas installer.

The conversion instructions and LP orifices can be found attached to the range next to the pressure regulator.

Keep these instructions and the orifices in case you want to convert back to natural gas.

Before you call for service...



Troubleshooting Tips
Save time and money! Review the charts on the following pages first and you may not need to call for service.

Problem	Possible Causes	What To Do
Top burners do not light or do not burn evenly	Plug on range is not completely inserted in the electrical outlet.	<ul style="list-style-type: none"> Make sure electrical plug is plugged into a live, properly grounded outlet.
	Burner hole or slits on the side of the burner may be clogged.	<ul style="list-style-type: none"> Remove the burners (on models with standard twin burners) or burner heads and caps (on models with sealed burners) and clean them with a sewing needle or twist-tie. Make sure you do not enlarge the holes. On sealed burner models, check and clean the electrode area for burned-on food or grease.
	Improper burner assembly.	<ul style="list-style-type: none"> Make sure the burner parts are installed correctly. See the <i>Care and cleaning of the range</i> section.
	Drip pans (if so equipped) are not installed correctly.	<ul style="list-style-type: none"> Make sure the drip pans are installed correctly.
Burner flames very large or yellow	Pilot(s) is (are) not lit (on standing pilot models).	<ul style="list-style-type: none"> See the <i>Light the Surface Burner Pilots</i> section in the <i>Installation Instructions</i>.
	Improper air to gas ratio.	<ul style="list-style-type: none"> If range is connected to LP gas, contact the person who installed your range or made the conversion.
Surface burners light but oven does not	The oven gas shut-off valve may have accidentally been moved during cleaning or moving.	<ul style="list-style-type: none"> To check the oven gas shut-off valve on sealed burner models, remove the broiler drawer or kick panel (see the <i>Care and cleaning of the range</i> section) and look for the gas shut-off lever at the back of the range.
		<ul style="list-style-type: none"> To check the oven gas shut-off valve on standard twin burner models, raise the cooktop and look for the gas shut-off lever at the extreme right rear corner. (Standing pilot models do not have a gas shut-off valve on the regulator.) Follow the directions in box A or B that match your regulator type.

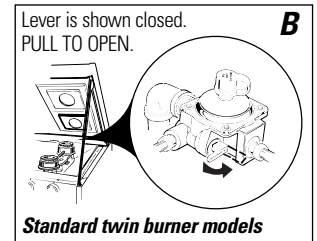
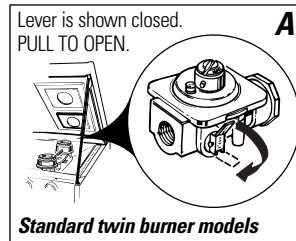
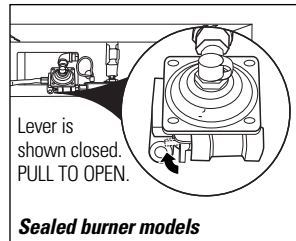

Problem	Possible Causes	What To Do
Clock does not work	Plug on range is not completely inserted in the electrical outlet.	<ul style="list-style-type: none"> • Make sure electrical plug is plugged into a live, properly grounded outlet.
	A fuse in your home may be blown or the circuit breaker tripped.	<ul style="list-style-type: none"> • Replace the fuse or reset the circuit breaker.
	Oven controls improperly set.	<ul style="list-style-type: none"> • See the <i>Using the clock and timer</i> section.
Food does not bake or roast properly	Oven controls improperly set.	<ul style="list-style-type: none"> • See the <i>Using the oven</i> section.
	Shelf position is incorrect.	<ul style="list-style-type: none"> • See the <i>Using the oven</i> section.
	Incorrect cookware or cookware of improper size being used.	<ul style="list-style-type: none"> • See the <i>Using the oven</i> section.
	Oven thermostat needs adjustment.	<ul style="list-style-type: none"> • See the <i>Adjust the oven thermostat—Do it yourself!</i> section.
	Clock not set correctly.	<ul style="list-style-type: none"> • See the <i>Using the clock and timer</i> section.
	Aluminum foil used improperly in the oven.	<ul style="list-style-type: none"> • See the <i>Care and cleaning of the range</i> section.
	Oven bottom not securely seated in position.	<ul style="list-style-type: none"> • See the <i>Installation of the range</i> section.
Food does not broil properly	Oven controls improperly set.	<ul style="list-style-type: none"> • See the <i>Using the oven</i> section.
	Oven door and/or broiler drawer not closed.	<ul style="list-style-type: none"> • See the <i>Broiling</i> section.
	Improper shelf position being used.	<ul style="list-style-type: none"> • See the <i>Broiling guide</i>.
	Food being cooked in a hot pan.	<ul style="list-style-type: none"> • Use the broiling pan and grid that came with your range. Make sure it is cool.
	Cookware not suited for broiling.	<ul style="list-style-type: none"> • Use the broiling pan and grid that came with your range.
	Aluminum foil used on the the broiling pan and grid has not been fitted properly and slit as recommended.	<ul style="list-style-type: none"> • See the <i>Using the oven</i> section.
	Oven bottom not securely seated in position.	<ul style="list-style-type: none"> • See the <i>Installation of the range</i> section.
Oven temperature too hot or too cold	Oven thermostat needs adjustment.	<ul style="list-style-type: none"> • See the <i>Adjust the oven thermostat—Do it yourself!</i> section.
Oven light does not work	Light bulb is loose or defective.	<ul style="list-style-type: none"> • Tighten or replace the bulb.
	Plug on range is not completely inserted in the electrical outlet.	<ul style="list-style-type: none"> • Make sure electrical plug is plugged into a live, properly grounded outlet.
Oven not heating up	Pilot is not lit (on standing pilot models).	<ul style="list-style-type: none"> • See the <i>Light the Oven Pilot</i> section in the <i>Installation Instructions</i>.

Before you call for service...



Troubleshooting Tips

Problem	Possible Causes	What To Do
"Crackling" or "popping" sound	This is the sound of the metal heating and cooling during cooking.	<ul style="list-style-type: none"> • This is normal.
Rainbow effect in the oven window (on some models)	This is caused by the heat treatment applied to the oven window.	<ul style="list-style-type: none"> • This is normal.
Power outage, clock flashes	Power outage or surge.	<ul style="list-style-type: none"> • Reset the clock.
Strong odor	An odor from the insulation around the inside of the oven is normal for the first few times the oven is used.	<ul style="list-style-type: none"> • This is temporary.
	Improper air to gas ratio.	<ul style="list-style-type: none"> • Adjust oven burner air shutter.
Fan noise	A cooling fan may automatically turn on and off to cool internal parts.	<ul style="list-style-type: none"> • This is normal. The cooling fan will turn off and on.

GE Service Protection Plus™

GE, a name recognized worldwide for quality and dependability, offers you Service Protection Plus™—comprehensive protection on all your appliances—**No Matter What Brand!**

Benefits Include:

- Backed by GE
- All brands covered
- Unlimited service calls
- All parts and labor costs included
- No out-of-pocket expenses
- No hidden deductibles
- One 800 number to call

***We'll Cover Any Appliance.
Anywhere. Anytime.****

You will be completely satisfied with our service protection or you may request your money back on the remaining value of your contract. No questions asked. It's that simple.

Protect your refrigerator, dishwasher, washer and dryer, range, TV, VCR and much more—**any brand!** Plus there's no extra charge for emergency service and low monthly financing is available. Even icemaker coverage and food spoilage protection is offered. You can rest easy, knowing that all your valuable household products are protected against expensive repairs.

Place your confidence in GE and call us in the U.S. toll-free at **800.626.2224** for more information.

*All brands covered, up to 20 years old, in the continental U.S.

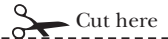

Please place in envelope and mail to:

General Electric Company
Warranty Registration Department
P.O. Box 32150
Louisville, KY 40232-2150

Consumer Product Ownership Registration

Dear Customer:

Thank you for purchasing our product and thank you for placing your confidence in us. We are proud to have you as a customer!

Follow these three steps to protect your new appliance investment:

1

Complete and mail your **Consumer Product Ownership Registration** today. Have the peace of mind of knowing we can contact you in the unlikely event of a safety modification.

2

After mailing the registration below, store this document in a safe place. It contains information you will need should you require service. Our service number is 800.GE.CARES (800.432.2737).

3

Read your Owner's Manual carefully. It will help you operate your new appliance properly.

Model Number

Serial Number

Important: If you did not get a registration card with your product, detach and return the form below to ensure that your product is registered, or register online at ge.com.



Consumer Product Ownership Registration



Model Number

Serial Number

Mr. Ms. Mrs. Miss

First Name

Last Name

Street Address

Apt. #

E-mail Address*

City

State

Zip Code

Date Placed In Use Month

Day

Year

Phone Number



GE Consumer & Industrial Appliances
General Electric Company
Louisville, KY 40225
ge.com

* Please provide your e-mail address to receive, via e-mail, discounts, special offers and other important communications from GE Appliances (GEA).

Check here if you do not want to receive communications from GEA's carefully selected partners.

FAILURE TO COMPLETE AND RETURN THIS CARD DOES NOT DIMINISH YOUR WARRANTY RIGHTS.

For information about GEA's privacy and data usage policy, go to ge.com and click on "Privacy Policy" or call 800.626.2224.

Accessories.



Looking For Something More?

You can find these accessories and many more at ge.com, or call 800.626.2002 (during normal business hours). Have your model number ready.

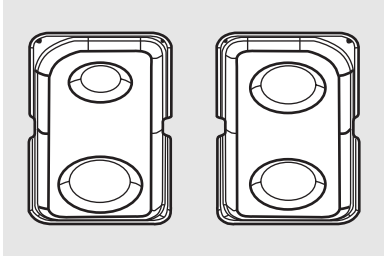

Drip Pans

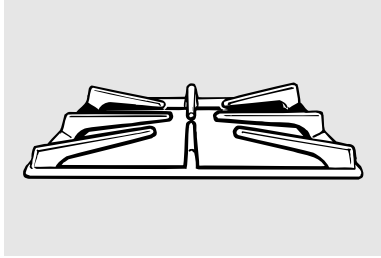

Grates

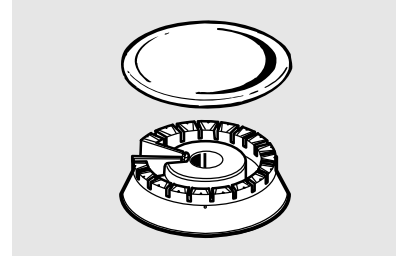

Surface Burners & Caps

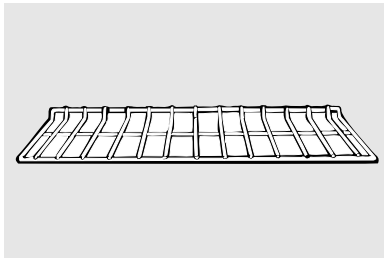

Oven Racks

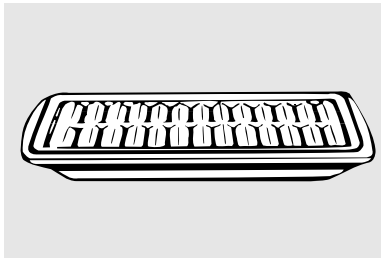

Broiler Pan



Cleaner



Light Bulbs

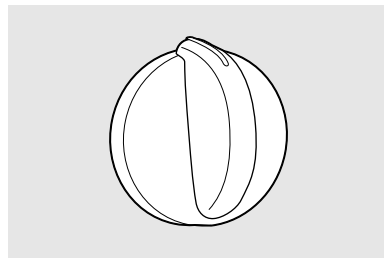

Knobs

Tired of discolored racks? Wishing you had extra-heavy-duty oven racks?

NOW AVAILABLE for your range:

GE's innovative, self-cleanable porcelain-coated oven racks!

- Heavy Duty
- Durable
- Able to be cleaned in a self-cleaning oven

Visit ge.com for more information.

GE Gas Range Warranty. *(For customers in the United States)*



All warranty service provided by our Factory Service Centers, or an authorized Customer Care® technician. To schedule service, on-line, 24 hours a day, visit us at ge.com, or call 800.GE.CARES (800.432.2737). Please have serial number and model number available when calling for service.

Staple your receipt here.
Proof of the original purchase date is needed to obtain service under the warranty.

For The Period Of:

GE Will Replace:

One Year

From the date of the original purchase

Any part of the range which fails due to a defect in materials or workmanship. During this **limited one-year warranty**, GE will also provide, **free of charge**, all labor and in-home service to replace the defective part.

What GE Will Not Cover:

- Service trips to your home to teach you how to use the product.
- Improper installation, delivery or maintenance.
- Failure of the product if it is abused, misused, or used for other than the intended purpose or used commercially.
- Replacement of house fuses or resetting of circuit breakers.
- Damage to the product caused by accident, fire, floods or acts of God.
- Incidental or consequential damage caused by possible defects with this appliance.
- Damage caused after delivery.
- Product not accessible to provide required service.

EXCLUSION OF IMPLIED WARRANTIES—Your sole and exclusive remedy is product repair as provided in this Limited Warranty. Any implied warranties, including the implied warranties of merchantability or fitness for a particular purpose, are limited to one year or the shortest period allowed by law.

This warranty is extended to the original purchaser and any succeeding owner for products purchased for home use within the USA. If the product is located in an area where service by a GE Authorized Servicer is not available, you may be responsible for a trip charge or you may be required to bring the product to an Authorized GE Service Location for service. In Alaska, the warranty excludes the cost of shipping or service calls to your home.

Some states do not allow the exclusion or limitation of incidental or consequential damages. This warranty gives you specific legal rights, and you may also have other rights which vary from state to state. To know what your legal rights are, consult your local or state consumer affairs office or your state's Attorney General.

Warrantor: General Electric Company, Louisville, KY 40225

GE Gas Range Warranty. *(For customers in Canada)*



All warranty service provided by our Factory Service Centers or an authorized Customer Care® technician. For service, call 1.800.361.3400. Please have serial number and model number available when calling for service.

Staple your receipt here.
Proof of the original purchase date is needed to obtain service under the warranty.

For The Period Of: **Camco Will Replace:**

One Year
From the date of the original purchase

Any part of the range which fails due to a defect in materials or workmanship. During this **limited one-year warranty**, Camco will also provide, **free of charge**, all labor and related service to replace the defective part.

What Camco Will Not Cover:

- Service trips to your home to teach you how to use the product.
- Improper installation, delivery or maintenance.
- Failure of the product if it is abused, misused, or used for other than the intended purpose or used commercially.
- Replacement of house fuses or resetting of circuit breakers.
- Damage to the product caused by accident, fire, floods or acts of God.
- Incidental or consequential damage caused by possible defects with this appliance.
- Damage caused after delivery.
- Product not accessible to provide required service.

EXCLUSION OF IMPLIED WARRANTIES—Your sole and exclusive remedy is product repair as provided in this Limited Warranty. Any implied warranties, including the implied warranties of merchantability or fitness for a particular purpose, are limited to one year or the shortest period allowed by law.

WARRANTOR IS NOT RESPONSIBLE FOR CONSEQUENTIAL DAMAGES.

Warrantor: CAMCO INC.

Safety Instructions

Operating Instructions

Installation Instructions

Troubleshooting Tips

Consumer Support

Consumer Support.



GE Appliances Website

ge.com

Have a question or need assistance with your appliance? Try the GE Appliances Website 24 hours a day, any day of the year! For greater convenience and faster service, you can now download Owner's Manuals, order parts, catalogs, or even schedule service on-line. You can also "Ask Our Team of Experts™" your questions, and so much more...



Schedule Service

ge.com

Expert GE repair service is only one step away from your door. Get on-line and schedule your service at your convenience 24 hours any day of the year! Or call 800.GE.CARES (800.432.2737) during normal business hours. In Canada, call 1.800.361.3400.



Real Life Design Studio

ge.com

GE supports the Universal Design concept—products, services and environments that can be used by people of all ages, sizes and capabilities. We recognize the need to design for a wide range of physical and mental abilities and impairments. For details of GE's Universal Design applications, including kitchen design ideas for people with disabilities, check out our Website today. For the hearing impaired, please call 800.TDD.GEAC (800.833.4322). In Canada, contact: Manager, Consumer Relations, Camco Inc., 1 Factory Lane, Suite 310, Moncton, N.B., E1C 9M3.



Extended Warranties

ge.com

Purchase a GE extended warranty and learn about special discounts that are available while your warranty is still in effect. You can purchase it on-line anytime, or call 800.626.2224 during normal business hours. GE Consumer Home Services will still be there after your warranty expires. In Canada, call 1.800.461.3636.

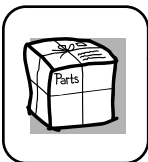

Parts and Accessories

ge.com

Individuals qualified to service their own appliances can have parts or accessories sent directly to their homes (VISA, MasterCard and Discover cards are accepted). Order on-line today, 24 hours every day or by phone at 800.626.2002 during normal business hours.

Instructions contained in this manual cover procedures to be performed by any user. Other servicing generally should be referred to qualified service personnel. Caution must be exercised, since improper servicing may cause unsafe operation. In Canada, please consult your yellow pages for your local Camco number.



Contact Us

ge.com

If you are not satisfied with the service you receive from GE, contact us on our Website with all the details including your phone number, or write to: General Manager, Customer Relations, GE Appliances, Appliance Park, Louisville, KY 40225. In Canada, to: Manager, Consumer Relations, Camco Inc., 1 Factory Lane, Suite 310, Moncton, N.B., E1C 9M3.



Register Your Appliance

ge.com

Register your new appliance on-line—at your convenience! Timely product registration will allow for enhanced communication and prompt service under the terms of your warranty, should the need arise. You may also mail in the pre-printed registration card included in the packing material.